

ENGLISH





**MO-6800S(D)/DD Series
CAUTIONS FOR SAFETY**

TO ENSURE SAFE USE OF YOUR SEWING MACHINE









For the sewing machine, automatic machine and ancillary devices (hereinafter collectively referred to as "machine"), it is inevitable to conduct sewing work near moving parts of the machine. This means that there is always a possibility of unintentionally coming in contact with the moving parts. Operators who actually operate the machine and maintenance personnel who are involved in maintenance and repair of the machine are strongly recommended to carefully read to fully understand the following **SAFETY PRECAUTIONS** before using/maintaining the machine. The content of the **SAFETY PRECAUTIONS** includes items which are not contained in the specifications of your product.



The risk indications are classified into the following three different categories to help understand the meaning of the labels. Be sure to fully understand the following description and strictly observe the instructions.

(I) Explanation of risk levels

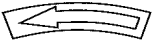
	DANGER : This indication is given where there is an immediate danger of death or serious injury if the person in charge or any third party mishandles the machine or does not avoid the dangerous situation when operating or maintaining the machine.
	WARNING : This indication is given where there is a potentiality for death or serious injury if the person in charge or any third party mishandles the machine or does not avoid the dangerous situation when operating or maintaining the machine.
	CAUTION : This indication is given where there is a danger of medium to minor injury if the person in charge or any third party mishandles the machine or does not avoid the dangerous situation when operating or maintaining the machine.
	Items requiring special attention.

(II) Explanation of pictorial warning indications and warning labels

Pictorial warning indication		There is a risk of injury if contacting a moving section.	Pictorial warning indication		Be aware that holding the sewing machine during operation can hurt your hands.
		There is a risk of electrical shock if contacting a high-voltage section.			There is a risk of entanglement in the belt resulting in injury.
		There is a risk of a burn if contacting a high-temperature section.			There is a risk of injury if you touch the button carrier.
		Be aware that eye deficiency can be caused by looking directly at the laser beam.	Indication label		The correct direction is indicated.
		There is a risk of contact between your head and the sewing machine.			Connection of a earth cable is indicated.

 	<p style="margin: 0;">注意 CAUTION</p> <p style="margin: 0; font-size: small;">機械作動部份請注意裝上保護裝置。 穿線、換線、調整、清潔時請注意關閉電源。 Moving parts may cause injury. Operate with safety devices. Turn off main switch before threading, changing bobbin and needle, cleaning etc.</p>	<p>①</p> <ul style="list-style-type: none"> • There is the possibility that slight to serious injury or death may be caused. • There is the possibility that injury may be caused by touching moving part.
--	--	--



SAFETY PRECAUTIONS

Accident means "to cause personal injury or death or damage to property."



DANGER

1. When it is necessary to open the control box containing electrical parts, be sure to turn the power off and wait for five minutes or more before opening the cover in order to prevent accident leading to electrical shock.



CAUTION

Basic precaution

1. Be sure to read the instruction manual and other explanatory documents supplied with accessories of the machine before using the machine. Carefully keep the instruction manual and the explanatory documents at hand for quick reference.
2. The content of this section includes items which are not contained in the specifications of your product.
3. Be sure to wear safety goggles to protect against accident caused by needle breakage.
4. Those who use a heart pacer have to use the machine after consultation with a medical specialist.

Safety devices and warning labels

1. Be sure to operate the machine after verifying that safety device(s) is correctly installed in place and works normally in order to prevent accident caused by lack of the device(s).
2. If any of the safety devices is removed, be sure to replace it and verify that it works normally in order to prevent accident that can result in personal injury or death.
3. Be sure to keep the warning labels adhered on the machine clearly visible in order to prevent accident that can result in personal injury or death. If any of the labels has stained or come unstuck, be sure to change it with a new one.

Application and modification

1. Never use the machine for any application other than its intended one and in any manner other than that prescribed in the instruction manual in order to prevent accident that can result in personal injury or death. JUKI assumes no responsibility for damages or personal injury or death resulting from the use of the machine for any application other than the intended one.
2. Never modify and alter the machine in order to prevent accident that can result in personal injury or death. JUKI assumes no responsibility for damages or personal injury or death resulting from the machine which has been modified or altered.

Education and training

1. In order to prevent accident resulting from unfamiliarity with the machine, the machine has to be used only by the operator who has been trained/educated by the employer with respect to the machine operation and how to operate the machine with safety to acquire adequate knowledge and operation skill. To ensure the above, the employer has to establish an education/training plan for the operators and educate/train them beforehand.

Items for which the power to the machine has to be turned off

Turning the power off: Turning the power switch off, then removing the power plug from the outlet.

This applies to the following.

1. Be sure to immediately turn the power off if any abnormality or failure is found or in the case of power failure in order to protect against accident that can result in personal injury or death.
2. To protect against accident resulting from abrupt start of the machine, be sure to carry out the following operations after turning the power off. For the machine incorporating a clutch motor, in particular, be sure to carry out the following operations after turning the power off and verifying that the machine stops completely.
 - 2-1. For example, threading the parts such as the needle, looper, spreader etc. which have to be threaded, or changing the bobbin.
 - 2-2. For example, changing or adjusting all component parts of the machine.
 - 2-3. For example, when inspecting, repairing or cleaning the machine or leaving the machine.
3. Be sure to remove the power plug by holding the plug section instead of the cord section in order to prevent electrical-shock, earth-leakage or fire accident.
4. Be sure to turn the power off whenever the machine is left unattended between works.
5. Be sure to turn the power off in the case of power failure in order to prevent accident resulting of breakage of electrical components.

PRECAUTIONS TO BE TAKEN IN VARIOUS OPERATION STAGES

Transportation

1. Be sure to lift and move the machine in a safe manner taking the machine weight in consideration. Refer to the text of the instruction manual for the mass of the machine.
2. Be sure to take sufficient safety measures to prevent falling or dropping before lifting or moving the machine in order to protect against accident that can result in personal injury or death.
3. Once the machine has been unpacked, never re-pack it for transportation to protect the machine against breakage resulting from unexpected accident or dropping.

Unpacking

1. Be sure to unpack the machine in the prescribed order in order to prevent accident that can result in personal injury or death. In the case the machine is crated, in particular, be sure to carefully check nails. The nails have to be removed.
2. Be sure to check the machine for the position of its center of gravity and take it out from the package carefully in order to prevent accident that can result in personal injury or death.

Installation

(I) Table and table stand

1. In order to prevent accidents causing injury or death, be sure to use the specified table stand components. In the case it is unavoidable to use any unspecified table stand components, be sure to use those that are able to adequately withstand the machine weight and the reactive force during operation.
2. If casters are fitted to the table stand, be sure to use the casters with a locking mechanism and lock them to secure the machine during the operation, maintenance, inspection and repair in order to prevent accident that can result in personal injury or death.

(II) Cable and wiring

1. Be sure to prevent an extra force from being applied to the cable during the use in order to prevent electrical-shock, earth-leakage or fire accident. In addition, if it is necessary to cable near the operating section such as the V-belt, be sure to provide a space of 30 mm or more between the operating section and the cable.
2. Be sure to avoid starburst connection in order to prevent electrical-shock, earth-leakage or fire accident.
3. Be sure to securely connect the connectors in order to prevent electrical-shock, earth-leakage or fire accident. In addition, be sure to remove the connector while holding its connector section.

(III) Grounding

1. Be sure to have an electrical expert install an appropriate power plug in order to prevent accident caused by earth-leakage or dielectric strength voltage fault. In addition, be sure to connect the power plug to the grounded outlet without exceptions.
2. Be sure to ground the earth cable in order to prevent accident caused by earth leakage.

(IV) Motor

1. In order to prevent accidents due to burning, be sure to use a motor with rated capacity (specified product).
2. If a commercially available clutch motor is used with the machine, be sure to select one with an entanglement preventive pulley cover in order to protect against being entangled by the V-belt.

Before operation

1. Be sure to make sure that the connectors and cables are free from damage, dropout and looseness before turning the power on in order to prevent accident resulting in personal injury or death.
2. Never put your hand into the moving sections of the machine in order to prevent accident that can result in personal injury or death.
In addition, check to be sure that the direction of rotation of the pulley agrees with the arrow shown on pulley.
3. If the table stand with casters is used, be sure to secure the table stand by locking the casters or with adjusters, if provided, in order to protect against accident caused by abrupt start of the machine.

During operation

1. Be sure not to put your fingers, hair or clothing close to the moving sections such as the handwheel, hand pulley and motor or place something near those sections while the machine is in operation in order to prevent accident caused by entanglement that can result in personal injury or death.
2. Be sure not to place your fingers near the surround area of the needle or inside the thread take-up lever cover when turning the power on or while the machine is in operation in order to prevent accident that can result in personal injury or death.
3. The machine runs at a high speed. Never bring your hands near the moving sections such as looper, spreader, needle bar, hook and cloth trimming knife during operation in order to protect your hands against injury. In addition, be sure to turn the power off and check to be sure that the machine completely stops before changing the thread.
4. Be careful not to allow your fingers or any other parts of your body to be caught between the machine and table when removing the machine from or replacing it on the table in order to prevent accident that can result in personal injury or death.

5. Be sure to turn the power off and check to be sure that the machine and motor completely stop before removing the belt cover and V-belt in order to prevent accident caused by abrupt start of the machine or motor.
6. If a servomotor is used with the machine, the motor does not produce noise while the machine is at rest. Be sure not to forget to turn the power off in order to prevent accident caused by abrupt start of the motor.
7. Never use the machine with the cooling opening of the motor power box shielded in order to prevent fire accident by overheat.

Lubrication

1. For parts of the machine requiring oiling, the specified oil and specified grease should be used.
2. If the oil adheres on your eye or body, be sure to immediately wash it off in order to prevent inflammation or irritation.
3. If the oil is swallowed unintentionally, be sure to immediately consult a medical doctor in order to prevent diarrhea or vomiting.

Maintenance

1. In prevention of accident caused by unfamiliarity with the machine, repair and adjustment has to be carried out by a service technician who is thoroughly familiar with the machine within the scope defined in the instruction manual. In addition, be sure to use the specified part(s) at the time of replacement of parts. We shall have no liability for any accidents resulting from improper repair or adjustment of the machine and from the use of any part other than specified ones.
2. In prevention of accident caused by unfamiliarity with the machine or electrical-shock accident, be sure to ask an electrical technician of your company or JUKI or distributor in your area for repair and maintenance (including wiring) of electrical components.
3. When carrying out repair or maintenance of the machine which uses air-driven parts such as an air cylinder, be sure to remove the air supply pipe to expel air remaining in the machine beforehand, in order to prevent accident caused by abrupt start of the air-driven parts.
4. Be sure to check that screws and nuts are free from looseness after completion of repair, adjustment and part replacement.
5. Be sure to periodically clean up the machine during its duration of use. Be sure to turn the power off and verify that the machine and motor stop completely before cleaning the machine in order to prevent accident caused by abrupt start of the machine or motor.
6. Be sure to turn the power off and verify that the machine and motor stop completely before carrying out maintenance, inspection or repair of the machine. (For the machine with a clutch motor, the motor will keep running for a while by inertia even after turning the power off. So, be careful.)
7. If the machine cannot be normally operated after repair or adjustment, immediately stop operation and contact JUKI or the distributor in your area for repair in order to prevent accident that can result in personal injury or death.
8. If the fuse has blown, be sure to turn the power off and eliminate the cause of blowing of the fuse and replace the blown fuse with a new one in order to prevent accident that can result in personal injury or death.
9. Be sure to periodically clean up the air vent of the fan and inspect the area around the wiring in order to prevent fire accident of the motor.

Operating environment

1. Be sure to use the machine under the environment which is not affected by strong noise source (electromagnetic waves) such as a high-frequency welder in order to prevent accident caused by malfunction of the machine.
2. Never operate the machine in any place where the voltage fluctuates by more than "rated voltage $\pm 10\%$ " in order to prevent accident caused by malfunction of the machine.
3. Be sure to verify that the air-driven device such as an air cylinder operates at the specified air pressure before using it in order to prevent accident caused by malfunction of the machine.
4. To use the machine with safety, be sure to use it under the environment which satisfies the following conditions:

Ambient temperature during operation	5°C to 35°C
Relative humidity during operation	35 % to 85 %
5. Dew condensation can occur if bringing the machine suddenly from a cold environment to a warm one. So, be sure to turn the power on after having waited for a sufficient period of time until there is no sign of water droplet in order to prevent accident caused by breakage or malfunction of the electrical components.
6. Be sure to stop operation when lightning flashes for the sake of safety and remove the power plug in order to prevent accident caused by breakage or malfunction of the electrical components.
7. Depending on the radio wave signal condition, the machine may generate noise in the TV or radio. If this occurs, use the TV or radio with kept well away from the machine.
8. In order to ensure the work environment, local laws and regulations in the country where the sewing machine is installed shall be followed.
In the case the noise control is necessary, an ear protector or other protective gear should be worn according to the applicable laws and regulations.
9. Disposal of products and packages and treatment of used lubricating oil should be carried out properly according to the relevant laws of the country in which the sewing machine is used.

MO-6800S(D)/DD Series for JA

This model is intended for commercial use.

BEFORE OPERATION

“IMPORTANT SAFETY INSTRUCTIONS”

When using the sewing machine, basic safety precautions should always be followed, including the following: Read all instructions before using

DANGER –To reduce the risk of electric shock:

WARNING –To reduce the risk of burns, fire, electric shock, or injury to persons:

1. Do not allow to be used as a toy. Close attention is necessary when this machine is used by or near children.
2. Use this machine only for its intended use as described in this manual. Use only attachments recommended by the manufacturer as contained in this manual.
3. Never operate this machine if it is not working properly, if it has been dropped or damaged, or dropped into water. Return the machine to the nearest authorized dealer or service center for examination, repair, electrical or mechanical adjustment.
4. Never drop or insert any object into any opening.
5. Do not use outdoors.
6. Do not operate where aerosol (spray) products are being used or where oxygen is being administered.
7. To disconnect, turn all controls to the off position, then remove plug from outlet.
8. Never operate the machine unless its oil pan (tank) has been filled with oil.

OPERATION PRECAUTIONS

“SAVE THESE INSTRUCTIONS”

1. Never operate the machine with any air openings blocked. Keep ventilation openings of the sewing machine free from the accumulation of lint, dust, and loose cloth.
2. Keep fingers away from all moving parts. Special care is required around the sewing machine needle.
3. Always use the proper needle plate. The wrong plate can cause the needle to break.
4. Do not use bent needles.
5. Do not pull or push fabric while stitching. It may deflect the needle causing it to break.
6. Switch the sewing machine off when making any adjustments in the needle area, such as threading needle, changing needle, threading bobbin, or changing presser foot, and the like.
7. Always disconnect power source from sewing machine when removing covers, lubricating, or when making any other user servicing adjustments mentioned in the Instruction manual.
8. Keep your hands away from the needle when you turn the power switch ON or while the machine is operating.
9. Do not put your fingers into the thread take-up cover while the machine is operating.
10. Be sure to turn the power switch OFF before tilting the machine head or removing the V belt.
11. While the sewing machine is in operation, be careful not to allow your or any other person's head or hands to come close to the handwheel, V belt, bobbin winder or motor. Also, do not place anything close to them. Doing so may be dangerous.
12. If your machine is provided with a belt cover, finger guard or any other protectors, do not operate your machine with any of them removed.
13. To achieve security, be sure that the power supply earth wire has been connected before operating the sewing machine.
14. No motor sound is heard when the sewing machine is not operating. So, do not forget to turn the power OFF at the end of work.
15. When you move the unit from a cold place directly to a warm place, dew condensation may result. Turn ON the power to the unit after you have confirmed there is no fear of dew condensation.
16. In case of thunder, be sure to stop the unit and remove the power plug from the receptacle for extra safety.
17. Whenever you connect/remove the power connector or the like, be sure to turn OFF the power switch beforehand.

Precautions to be taken so as to use the MO-6800S(D)/DD Series more safely



1. So as to avoid electric shock hazards, do not open the cover of the electrical box of the motor or touch any part inside the electrical box with the power to the machine turned ON.



1. Never operate the sewing machine without installing the safety devices such as the electrical box cover and eye protective cover in order to prevent accidents causing injury or death.
2. So as to avoid electrical shock hazards and accidents caused by damaged electrical components, be sure to turn OFF the power switch before inserting/detaching the power plug.
3. To avoid electric shock hazards, never operate the machine with the ground wire for the power supply removed.
4. Never place your fingers, hair and clothes near the handwheel, or place anything near the handwheel as long as the sewing machine is in operation in order to prevent accidents due to entanglement that may result in injury or death.
5. So as to avoid possible injury to your hands and fingers, do not put any of them near the cloth cutting knife and the needle when turning the power to the machine or while the machine is in operation.
6. To prevent possible injury to your hands and fingers, do not put any of them inside the eye guard while the machine is in operation.
7. To avoid electric shock hazards and accidents arising from damaged electrical components, be sure to turn OFF the power switch before inserting/detaching the power plug.
8. So as to protect against possible personal injury resulting from abrupt start of the machine, make sure to turn OFF the power to the machine when you leave your machine.
9. In the event of a power failure, be sure to turn OFF the power to the machine to protect against possible personal injury resulting from abrupt start of the machine.
10. Never place your fingers under the presser foot in order to prevent accidents causing injury or death.
11. Before inspecting, adjusting or cleaning the machine, threading the machine head or replacing the needle, so as to protect against possible personal injury resulting from abrupt start of the machine, be sure to turn OFF the power to the machine so as to prevent an accident and confirm that the sewing machine will not operate even when depressing the foot pedal of the sewing machine.
12. Do not carry the sewing machine by holding the bottom of the cloth plate cover or electrical box cover in order to prevent accidents due to falling of the sewing machine that may result in injury or death. If cover(s) break to allow the sewing machine head to fall, personal injury can be caused.

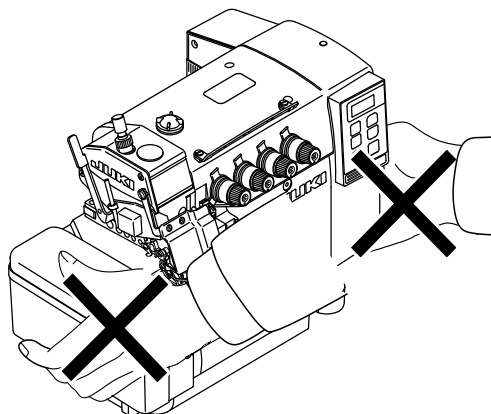

13. Be careful of handling this product so as not to pour water or oil, shock by dropping, and the like since this product is a precision instrument.
14. Please operate this machine in 80% of the maximum speed in the first four weeks for engagement. After four weeks, please do not operate under the maximum speed until replacing the new lubrication oil.
15. Periodically maintain and clean the machine to ensure and extend the usage term of the machine.



16. To prevent fires, periodically draw out the power plug from the plug socket and clean the root of the pins and the space between pins.
17. The motor does not produce the noise while the machine is stopped. To prevent accidents caused by abrupt start of the sewing machine, be sure to turn OFF the power switch when you stop the machine.

CAUTION BEFORE OPERATION



WARNING :

To avoid malfunction and damage of the machine, confirm the following.

- Read and understand well the content of this instruction book.
- Know the functions of major parts and understand the notices.
- Truly realize the meanings of all warning tags.
- Realize and be familiar with how to operate this machine.
- Operators please to keep well mental status.
- Operators shall wear appropriate and proper working suits.
- Develop the familiarity of how to operate the machine if needed.

SAFETY DEVICES AND WARNING LABELS

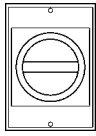
Power switch	
This is a switch for disconnecting the power unit of the sewing machine from the power supply.	
Power switch (EU type)	
This switch is used for disconnecting the power unit of the sewing machine from the power supply. It is also used as the emergency stop switch.	
Selection of the power switch	
Use the IEC60204-1-compliant power switch with rated current of 20 A or more and short-circuit breaking capacity of 120 A or more, which has the operating section in red against the yellow background.	

(For EU type)

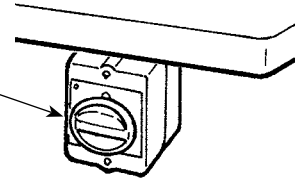

Warning label	
The label gives the minimum precautions to be taken when operating the sewing machine.	(Refer to the warning label on page i.)

Control box cover	
This is a cover for preventing contact between the control box components and the human body.	

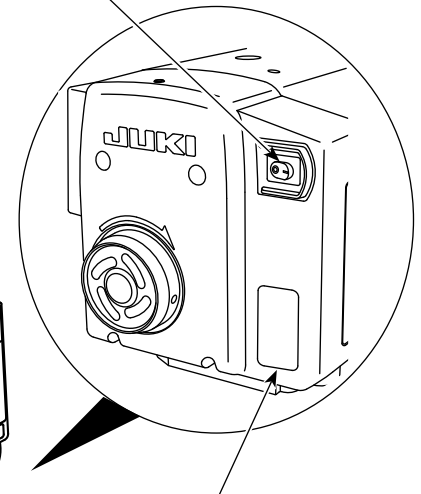

Eye protection cover	
This is a cover for protecting eyes from being injured by a broken needle.	

Finger guard	
This is a cover for preventing contact between fingers and the needle.	

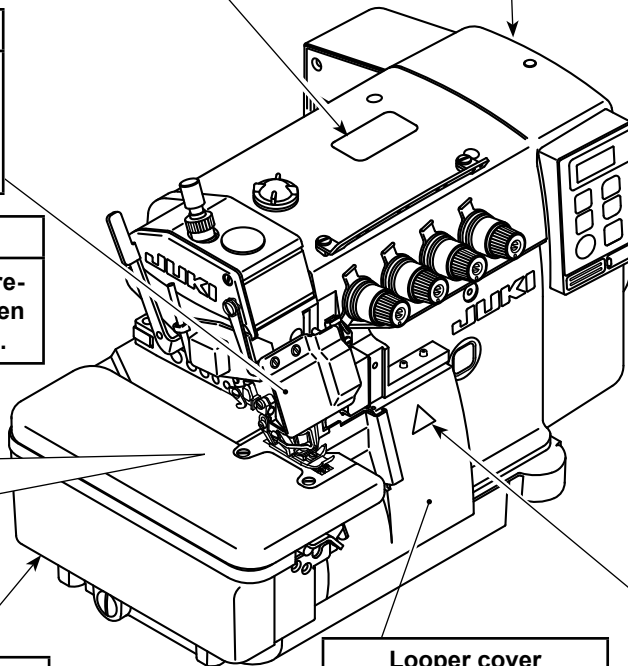
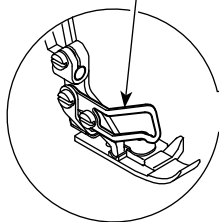

Warning label & high-voltage caution label	
This is the label for warning against the use of the control box to ensure safety and for calling attention to the presence of high-voltage section inside the cover.	

Cloth plate, cloth plate cover	
These covers protect hands, fingers, hair and clothes against injury that can be caused when being entangled by the rotary shaft.	

Looper cover	
This is a cover for preventing contact between the human body and the looper section.	

Warning label against pinching	
This is the warning label to prevent pinching of fingers and hands in the cloth trimming knife.	

CAUTION

In addition, be aware that the safety devices such as the "eye protection cover" and "finger guard" are sometimes omitted in the sketches, illustrations and figures included in the Instruction Manual for the explanation's sake. In the practical use, never remove those safety devices.