

ENGLISH

**LK-1903BN/BR35
CAUTIONS FOR SAFETY**

TO ENSURE SAFE USE OF YOUR SEWING MACHINE

For the sewing machine, automatic machine and ancillary devices (hereinafter collectively referred to as "machine"), it is inevitable to conduct sewing work near moving parts of the machine. This means that there is always a possibility of unintentionally coming in contact with the moving parts. Operators who actually operate the machine and maintenance personnel who are involved in maintenance and repair of the machine are strongly recommended to carefully read to fully understand the following **SAFETY PRECAUTIONS** before using/maintaining the machine. The content of the **SAFETY PRECAUTIONS** includes items which are not contained in the specifications of your product.

The risk indications are classified into the following three different categories to help understand the meaning of the labels. Be sure to fully understand the following description and strictly observe the instructions.

(I) Explanation of risk levels

	DANGER : This indication is given where there is an immediate danger of death or serious injury if the person in charge or any third party mishandles the machine or does not avoid the dangerous situation when operating or maintaining the machine.
	WARNING : This indication is given where there is a potentiality for death or serious injury if the person in charge or any third party mishandles the machine or does not avoid the dangerous situation when operating or maintaining the machine.
	CAUTION : This indication is given where there is a danger of medium to minor injury if the person in charge or any third party mishandles the machine or does not avoid the dangerous situation when operating or maintaining the machine.
	Items requiring special attention.

(II) Explanation of pictorial warning indications and warning labels

Pictorial warning indication		There is a risk of injury if contacting a moving section.	Pictorial warning indication		Be aware that holding the sewing machine during operation can hurt your hands.
		There is a risk of electrical shock if contacting a high-voltage section.			There is a risk of entanglement in the belt resulting in injury.
		There is a risk of a burn if contacting a high-temperature section.			There is a risk of injury if you touch the button carrier.
		Be aware that eye deficiency can be caused by looking directly at the laser beam.	Indication label		The correct direction is indicated.
		There is a risk of contact between your head and the sewing machine.			Connection of a earth cable is indicated.

Warning label		
	<ul style="list-style-type: none"> ① • There is the possibility that slight to serious injury or death may be caused. • There is the possibility that injury may be caused by touching moving part. ② • To perform sewing work with safety guard. • To perform sewing work with safety cover. • To perform sewing work with safety protection device. ③ • Be sure to turn the power OFF before carrying out "machine-head threading", "needle changing", "bobbin changing" or "oiling and cleaning". 	

Electrical-shock danger label		<p>⚠ 危険</p> <p>高電圧部分に触れて、大けがをすることがある。 電源を切って、5分以上たってからカバーをはずすこと。</p>	<p>⚠ DANGER</p> <p>Hazardous voltage will cause injury. Turn off main switch and unplug power cord and wait at least 5 minutes before opening this cover.</p>
-------------------------------	--	---	--

SAFETY PRECAUTIONS

Accident means "to cause personal injury or death or damage to property."



DANGER

1. When it is necessary to open the control box containing electrical parts, be sure to turn the power off and wait for five minutes or more before opening the cover in order to prevent accident leading to electrical shock.



CAUTION

Basic precaution

1. Be sure to read the instruction manual and other explanatory documents supplied with accessories of the machine before using the machine. Carefully keep the instruction manual and the explanatory documents at hand for quick reference.
2. The content of this section includes items which are not contained in the specifications of your product.
3. Be sure to wear safety goggles to protect against accident caused by needle breakage.
4. Those who use a heart pacer have to use the machine after consultation with a medical specialist.

Safety devices and warning labels

1. Be sure to operate the machine after verifying that safety device(s) is correctly installed in place and works normally in order to prevent accident caused by lack of the device(s).
2. If any of the safety devices is removed, be sure to replace it and verify that it works normally in order to prevent accident that can result in personal injury or death.
3. Be sure to keep the warning labels adhered on the machine clearly visible in order to prevent accident that can result in personal injury or death. If any of the labels has stained or come unstuck, be sure to change it with a new one.

Application and modification

1. Never use the machine for any application other than its intended one and in any manner other than that prescribed in the instruction manual in order to prevent accident that can result in personal injury or death. JUKI assumes no responsibility for damages or personal injury or death resulting from the use of the machine for any application other than the intended one.
2. Never modify and alter the machine in order to prevent accident that can result in personal injury or death. JUKI assumes no responsibility for damages or personal injury or death resulting from the machine which has been modified or altered.

Education and training

1. In order to prevent accident resulting from unfamiliarity with the machine, the machine has to be used only by the operator who has been trained/educated by the employer with respect to the machine operation and how to operate the machine with safety to acquire adequate knowledge and operation skill. To ensure the above, the employer has to establish an education/training plan for the operators and educate/train them beforehand.

Items for which the power to the machine has to be turned off

Turning the power off: Turning the power switch off, then removing the power plug from the outlet.
This applies to the following.

1. Be sure to immediately turn the power off if any abnormality or failure is found or in the case of power failure in order to protect against accident that can result in personal injury or death.
2. To protect against accident resulting from abrupt start of the machine, be sure to carry out the following operations after turning the power off. For the machine incorporating a clutch motor, in particular, be sure to carry out the following operations after turning the power off and verifying that the machine stops completely.
 - 2-1. For example, threading the parts such as the needle, looper, spreader etc. which have to be threaded, or changing the bobbin.
 - 2-2. For example, changing or adjusting all component parts of the machine.
 - 2-3. For example, when inspecting, repairing or cleaning the machine or leaving the machine.
3. Be sure to remove the power plug by holding the plug section instead of the cord section in order to prevent electrical-shock, earth-leakage or fire accident.
4. Be sure to turn the power off whenever the machine is left unattended between works.
5. Be sure to turn the power off in the case of power failure in order to prevent accident resulting of breakage of electrical components.

PRECAUTIONS TO BE TAKEN IN VARIOUS OPERATION STAGES

Transportation

1. Be sure to lift and move the machine in a safe manner taking the machine weight in consideration. Refer to the text of the instruction manual for the mass of the machine.
2. Be sure to take sufficient safety measures to prevent falling or dropping before lifting or moving the machine in order to protect against accident that can result in personal injury or death.
3. Once the machine has been unpacked, never re-pack it for transportation to protect the machine against breakage resulting from unexpected accident or dropping.

Unpacking

1. Be sure to unpack the machine in the prescribed order in order to prevent accident that can result in personal injury or death. In the case the machine is crated, in particular, be sure to carefully check nails. The nails have to be removed.
2. Be sure to check the machine for the position of its center of gravity and take it out from the package carefully in order to prevent accident that can result in personal injury or death.

Installation

(I) Table and table stand

1. Be sure to use JUKI genuine table and table stand in order to prevent accident that can result in personal injury or death. If it is inevitable to use a table and table stand which are not JUKI genuine ones, select the table and table stand which are able to support the machine weight and reaction force during operation.
2. If casters are fitted to the table stand, be sure to use the casters with a locking mechanism and lock them to secure the machine during the operation, maintenance, inspection and repair in order to prevent accident that can result in personal injury or death.

(II) Cable and wiring

1. Be sure to prevent an extra force from being applied to the cable during the use in order to prevent electrical-shock, earth-leakage or fire accident. In addition, if it is necessary to cable near the operating section such as the V-belt, be sure to provide a space of 30 mm or more between the operating section and the cable.
2. Be sure to avoid starburst connection in order to prevent electrical-shock, earth-leakage or fire accident.
3. Be sure to securely connect the connectors in order to prevent electrical-shock, earth-leakage or fire accident. In addition, be sure to remove the connector while holding its connector section.

(III) Grounding

1. Be sure to have an electrical expert install an appropriate power plug in order to prevent accident caused by earth-leakage or dielectric strength voltage fault. In addition, be sure to connect the power plug to the grounded outlet without exceptions.
2. Be sure to ground the earth cable in order to prevent accident caused by earth leakage.

(IV) Motor

1. Be sure to use the specified rated motor (JUKI genuine product) in order to prevent accident caused by burnout.
2. If a commercially available clutch motor is used with the machine, be sure to select one with an entanglement preventive pulley cover in order to protect against being entangled by the V-belt.

Before operation

1. Be sure to make sure that the connectors and cables are free from damage, dropout and looseness before turning the power on in order to prevent accident resulting in personal injury or death.
2. Never put your hand into the moving sections of the machine in order to prevent accident that can result in personal injury or death.
In addition, check to be sure that the direction of rotation of the pulley agrees with the arrow shown on pulley.
3. If the table stand with casters is used, be sure to secure the table stand by locking the casters or with adjusters, if provided, in order to protect against accident caused by abrupt start of the machine.

During operation

1. Be sure not to put your fingers, hair or clothing close to the moving sections such as the handwheel, hand pulley and motor or place something near those sections while the machine is in operation in order to prevent accident caused by entanglement that can result in personal injury or death.
2. Be sure not to place your fingers near the surround area of the needle or inside the thread take-up lever cover when turning the power on or while the machine is in operation in order to prevent accident that can result in personal injury or death.
3. The machine runs at a high speed. Never bring your hands near the moving sections such as looper, spreader, needle bar, hook and cloth trimming knife during operation in order to protect your hands against injury. In addition, be sure to turn the power off and check to be sure that the machine completely stops before changing the thread.
4. Be careful not to allow your fingers or any other parts of your body to be caught between the machine and table when removing the machine from or replacing it on the table in order to prevent accident that can result in personal injury or death.

5. Be sure to turn the power off and check to be sure that the machine and motor completely stop before removing the belt cover and V-belt in order to prevent accident caused by abrupt start of the machine or motor.
6. If a servomotor is used with the machine, the motor does not produce noise while the machine is at rest. Be sure not to forget to turn the power off in order to prevent accident caused by abrupt start of the motor.
7. Never use the machine with the cooling opening of the motor power box shielded in order to prevent fire accident by overheat.

Lubrication

1. Be sure to use JUKI genuine oil and JUKI genuine grease to the parts to be lubricated.
2. If the oil adheres on your eye or body, be sure to immediately wash it off in order to prevent inflammation or irritation.
3. If the oil is swallowed unintentionally, be sure to immediately consult a medical doctor in order to prevent diarrhea or vomiting.

Maintenance

1. In prevention of accident caused by unfamiliarity with the machine, repair and adjustment has to be carried out by a service technician who is thoroughly familiar with the machine within the scope defined in the instruction manual. Be sure to use JUKI genuine parts when replacing any of the machine parts. JUKI assumes no responsibility for any accident caused by improper repair or adjustment or the use of any part other than JUKI genuine one.
2. In prevention of accident caused by unfamiliarity with the machine or electrical-shock accident, be sure to ask an electrical technician of your company or JUKI or distributor in your area for repair and maintenance (including wiring) of electrical components.
3. When carrying out repair or maintenance of the machine which uses air-driven parts such as an air cylinder, be sure to remove the air supply pipe to expel air remaining in the machine beforehand, in order to prevent accident caused by abrupt start of the air-driven parts.
4. Be sure to check that screws and nuts are free from looseness after completion of repair, adjustment and part replacement.
5. Be sure to periodically clean up the machine during its duration of use. Be sure to turn the power off and verify that the machine and motor stop completely before cleaning the machine in order to prevent accident caused by abrupt start of the machine or motor.
6. Be sure to turn the power off and verify that the machine and motor stop completely before carrying out maintenance, inspection or repair of the machine. (For the machine with a clutch motor, the motor will keep running for a while by inertia even after turning the power off. So, be careful.)
7. If the machine cannot be normally operated after repair or adjustment, immediately stop operation and contact JUKI or the distributor in your area for repair in order to prevent accident that can result in personal injury or death.
8. If the fuse has blown, be sure to turn the power off and eliminate the cause of blowing of the fuse and replace the blown fuse with a new one in order to prevent accident that can result in personal injury or death.
9. Be sure to periodically clean up the air vent of the fan and inspect the area around the wiring in order to prevent fire accident of the motor.

Operating environment

1. Be sure to use the machine under the environment which is not affected by strong noise source (electromagnetic waves) such as a high-frequency welder in order to prevent accident caused by malfunction of the machine.
2. Never operate the machine in any place where the voltage fluctuates by more than "rated voltage $\pm 10\%$ " in order to prevent accident caused by malfunction of the machine.
3. Be sure to verify that the air-driven device such as an air cylinder operates at the specified air pressure before using it in order to prevent accident caused by malfunction of the machine.
4. To use the machine with safety, be sure to use it under the environment which satisfies the following conditions:

Ambient temperature during operation	5°C to 35°C
Relative humidity during operation	35 % to 85 %
5. Dew condensation can occur if bringing the machine suddenly from a cold environment to a warm one. So, be sure to turn the power on after having waited for a sufficient period of time until there is no sign of water droplet in order to prevent accident caused by breakage or malfunction of the electrical components.
6. Be sure to stop operation when lightning flashes for the sake of safety and remove the power plug in order to prevent accident caused by breakage or malfunction of the electrical components.
7. Depending on the radio wave signal condition, the machine may generate noise in the TV or radio. If this occurs, use the TV or radio with kept well away from the machine.
8. In order to ensure the work environment, local laws and regulations in the country where the sewing machine is installed shall be followed.
In the case the noise control is necessary, an ear protector or other protective gear should be worn according to the applicable laws and regulations.
9. Disposal of products and packages and treatment of used lubricating oil should be carried out properly according to the relevant laws of the country in which the sewing machine is used.

Precautions to be taken so as to use the LK-1903BN/BR35 more safely



1. To avoid electric shock hazards, neither touch the motor or the button feeder, nor open the control box cover, and nor touch components mounted inside the control box while the power switch is turned ON.
2. Use the machine under the correct voltage setting.





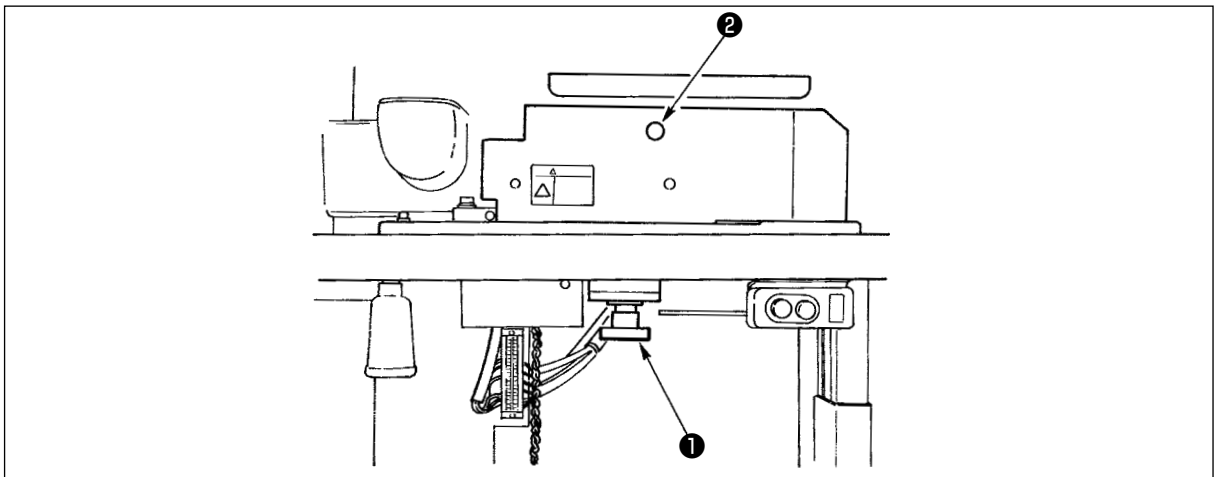

1. To avoid personal injuries, exercise care not to allow your fingers, etc. to be caught in the button carrier acting to supply buttons during operating the machine.
2. Do not use the buttons other than those specified in the specifications of this machine.
3. Be sure to use the button carrier and the pattern suitable for the buttons to be used.
4. After changing the shape of button, the pattern or enlargement/reduction of the sewing size, make sure of the needle entry point without fail.
5. So as to prevent possible accidents caused by abrupt start of the sewing machine, depress the pedal after ascertaining that there is no interfering thing under the needle when winding the bobbin thread.
6. Use the feed plate suitable for the buttons to be used.
7. When tilting the sewing machine, make sure that the button carrier is located at the origin position (the position where the button position is determined.). If not, turn spinner oscillating arm motor knob ❶ until the carrier is brought to its origin.

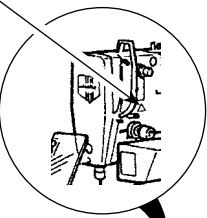
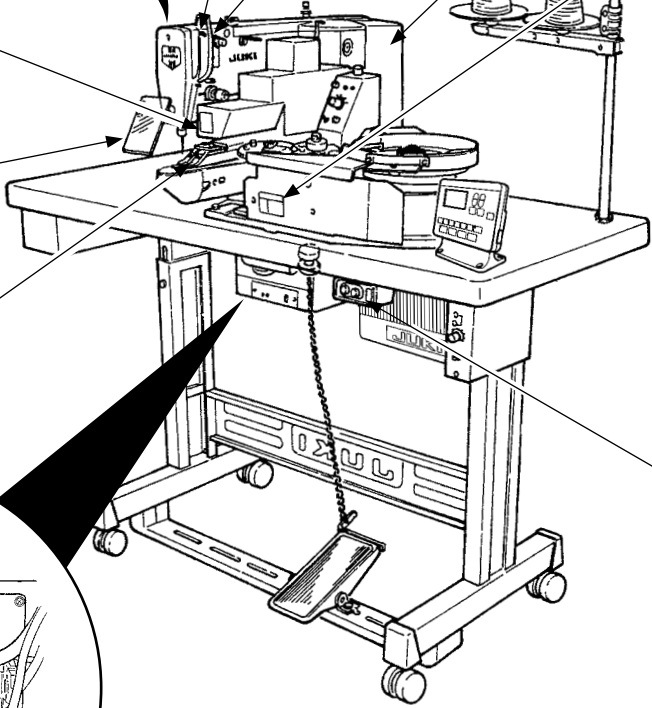
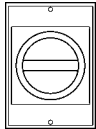
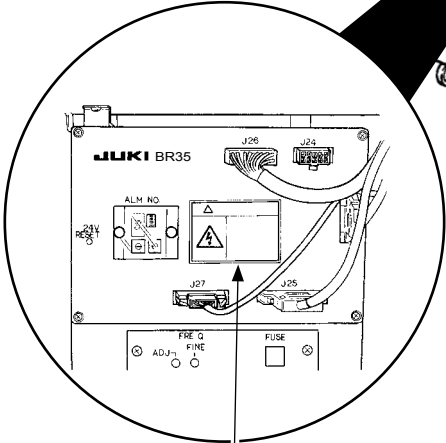

8. When Error "4" indicating an occurrence of a spinner oscillating arm failure or Error "5" indicating an occurrence of an index unit failure is given, the reset switch will be inoperative in order to protect the mechanical components. In this case, turn OFF the power to the machine once, and then re-turn ON the power.
9. This machine is equipped with the continuous cycle sewing feature. When you keep depressing the pedal, therefore, the buttons will be continuously fed from the button feeder. So, be careful.
10. If tightening too firmly screws of such components as the feed plate and the adjusting plate which are made of resin, the resin breakage may occur. So, be careful.
11. Apply grease on the worm gear and cam periodically (every six months).
12. The work attachment comes in two different types, the standard type and the large-button type (separate order). Whenever you have replaced the work attachment, be sure to adjust the fine positioning completion switch. (Refer to "[V.11.\(2\) Adjusting the fine positioning completion switch \(RFIN\)](#)" INSTRUCTION MANUAL for LK-1903BN/BR35 p. 22.)
13. If a button clogs in the index unit, turn first manual spinner oscillating shaft ❷ counterclockwise using a slit screwdriver until it is released.
14. Sensitivity of the button feeder is very delicate, so be sure to adjust it carefully.
15. Connect the connectors while checking the correct direction of the respective connectors.
16. When the operation panel is installed on the top surface of the table, pass the cable of the operation panel to the rear face of the table through the table hole where BR device cable is wired.
17. Be careful of handling this product so as not to pour water or oil, shock by dropping, and the like since this product is a precision instrument.
18. This is a Class A product. In a domestic environment this product may cause radio interference, in which case the user may be required to make corrective actions.
19. Be aware that the button clamp device comes down by its own weight when you turn the power off. Be sure not to place your hands or fingers under it to prevent injury.

Safety devices and warning labels

<p>Warning label against pinching</p>		<p>Warning label</p>	<p>(Refer to the warning label on page i.)</p>	<p>Thread take-up lever cover</p>	<p>Motor cover</p>
<p>This label warns that fingers or other parts of human body can be pinched in the thread take-up lever.</p>		<p>The label gives the minimum precautions to be taken when operating the sewing machine.</p>		<p>This is a cover for preventing contact between the human body and the thread take-up lever.</p>	<p>This is a cover for preventing contact between the human body and the motor.</p>
<p>Warning label against pinching</p>				<p>Warning label</p>	<p>(Refer to the warning label on page i.)</p>
<p>This label indicates that there is a risk of contact between hands and fingers and the button carrier.</p>		<p>The label gives the minimum precautions to be taken when operating the sewing machine.</p>			
<p>Eye protection cover</p>	<p>This is a cover for preventing eye injury due to flying pieces of button broken by needle breakage.</p>		<p>Power switch</p>	<p>This is a switch for disconnecting the power unit of the sewing machine from the power supply.</p>	
<p>Finger guard</p>	<p>This is a cover for preventing contact between fingers and the needle.</p>		<p>Power switch (EU type)</p>	<p>This switch is used for disconnecting the power unit of the sewing machine from the power supply. It is also used as the emergency stop switch.</p>	
			<p>Selection of the power switch</p>		
<p>Electrical-shock danger label</p>				<p>(Refer to "Electrical-shock danger label" on page i.)</p>	<p>Electrical-shock danger label</p>
<p>In order to protect against electrical shock, safety precautions to be taken to avoid danger are written on this label.</p>	<p>(EU type)</p>		<p>In order to protect against electrical shock, safety precautions to be taken to avoid danger are written on this label.</p>	 <p>(EU type)</p>	<p>(Refer to "Electrical-shock danger label" on page i.)</p>

CAUTION

In addition, be aware that the safety devices such as the "eye protection cover" and "finger guard" are sometimes omitted in the sketches, illustrations and figures included in the Instruction Manual for the explanation's sake. In the practical use, never remove those safety devices.