

ENGLISH

**LK-1900B / IP-420
INSTRUCTION MANUAL**

* "CompactFlash(TM)" is the registered trademark of SanDisk Corporation, U.S.A.

CONTENTS

1. NAME OF EACH SECTION OF THE OPERATION PANEL.....	1
1-1 Body	1
1-2 Buttons to be used in common	3
2. BASIC OPERATION OF IP-420.....	4
3. LCD DISPLAY SECTION AT THE TIME OF SEWING SHAPE SELECTION	5
3-1 Sewing shape data input screen	5
3-2 Sewing screen.....	8
4. PERFORMING SEWING SHAPE SELECTION.....	11
5. SEWING SHAPE LIST	14
5-1 LK-1900B / LK-1901B / LK-1902B	14
5-2 LK-1903B	16
6. PERFORMING ITEM DATA CHANGE.....	17
7. CHECKING PATTERN SHAPE	19
8. CHANGING THREAD TENSION COMMAND AT EVERY NEEDLE ENTRY POINT ...	21
8-1 Adding or changing thread tension command at every needle entry point.....	21
8-2 Deleting thread tension command at every needle entry point	23
9. PERFORMING RELEASE OF GREASE-UP ERROR.....	25
10. USING TEMPORARY STOP.....	26
10-1 To continue performing sewing from some point in sewing	27
10-2 To perform re-sewing from the start	28
11. WINDING BOBBIN THREAD.....	29
12. USING COUNTER	30
12-1 Setting procedure of the counter	30
12-2 Count-up releasing procedure.....	33
12-3 How to change the counter value during sewing	33
13. PERFORMING NEW REGISTER OF USERS' PATTERN.....	34
14. PERFORMING NEW REGISTER OF PATTERN BUTTON	35
15. LCD DISPLAY SECTION AT THE TIME OF PATTERN BUTTON SELECTION.....	36
15-1 Pattern button data input screen.....	36
15-2 Sewing screen.....	39
16. PERFORMING PATTERN BUTTON No. SELECTION	42
16-1 Selection from the data input screen.....	42
16-2 Selection by means of the shortcut button.....	43
17. CHANGING CONTENTS OF PATTERN BUTTON.....	44
18. NAMING PATTERN	46
19. COPYING PATTERN BUTTON.....	47
20. CHANGING SEWING MODE.....	49

21. LCD DISPLAY SECTION AT THE TIME OF COMBINATION SEWING.....	50
21-1 Pattern input screen	50
21-2 Sewing screen.....	52
22. PERFORMING COMBINATION SEWING	55
22-1 How to create combination data.....	55
22-2 Selection of combination data.....	56
22-3 How to delete combination data.....	57
22-4 How to delete combination data step	58
23. CHANGING MEMORY SWITCH DATA	59
23-1 How to change memory switch data.....	59
23-1-1 Level 1.....	59
23-1-2 Level 2.....	61
23-2 Memory switch data list	62
23-2-1 Level 1.....	62
23-2-2 Level 2.....	68
24. ERROR CODE LIST	72
25. MESSAGE LIST.....	80
26. USING COMMUNICATION FUNCTION	83
26-1 Handling possible data.....	83
26-2 Performing communication by using the media.....	84
26-3 Performing format.....	87
26-4 Performing communication	88
26-5 Take-in of the data	89
26-6 Taking in plural data together.....	91
27. INFORMATION FUNCTION.....	93
27-1 Observing the maintenance inspection information.....	93
27-2 Inputting the inspection time.....	95
27-3 Releasing procedure of the warning.....	96
27-4 Observing the production control information.....	97
27-4-1 When displaying from the information screen.....	97
27-4-2 When displaying from the sewing screen	99
27-5 Performing setting of the production control information	100
27-6 Observing the working measurement information.....	104
28. TRIAL SEWING FUNCTION.....	108
28-1 Performing trial sewing.....	108
29. THREAD TENSION VALUE DISPLAY COLOR LIST.....	111
30. SETTING APPROVAL/DISAPPROVAL OF CALLING OF PATTERN DATA.....	112
31. PERFORMING ADJUSTMENT OF ORIGIN OF PRESSER.....	113
32. PERFORMING KEY LOCK.....	114
33. DISPLAYING VERSION INFORMATION.....	116
34. USING CHECK PROGRAM.....	117

34-1 To display the check program screen.....	117
34-2 Performing compensation of touch panel.....	119
34-3 Performing LCD check	122
34-4 Performing sensor check.....	123
34-5 Number of rotations of main motor check	126
34-6 Performing output check	127
34-7 Performing X/Y motors/origin sensors check.....	129
34-8 Performing presser/thread trimmer motor/origin sensor check	130
34-9 Performing thread clamp motor/origin sensor check	131
34-10 How to carry out the continuous operation	132
35. COMMUNICATION SCREEN OF MAINTENANCE PERSONNEL LEVEL.....	133
35-1 Data which are possible to be handled.....	133
35-2 Displaying maintenance personnel level.....	134
35-3 Performing rewriting of program.....	135
36. INFORMATION SCREEN OF THE MAINTENANCE PERSONNEL LEVEL.....	137
36-1 Display of error record	137
36-2 Display of the cumulative working information	139

1. NAME OF EACH SECTION OF THE OPERATION PANEL

1-1 Body

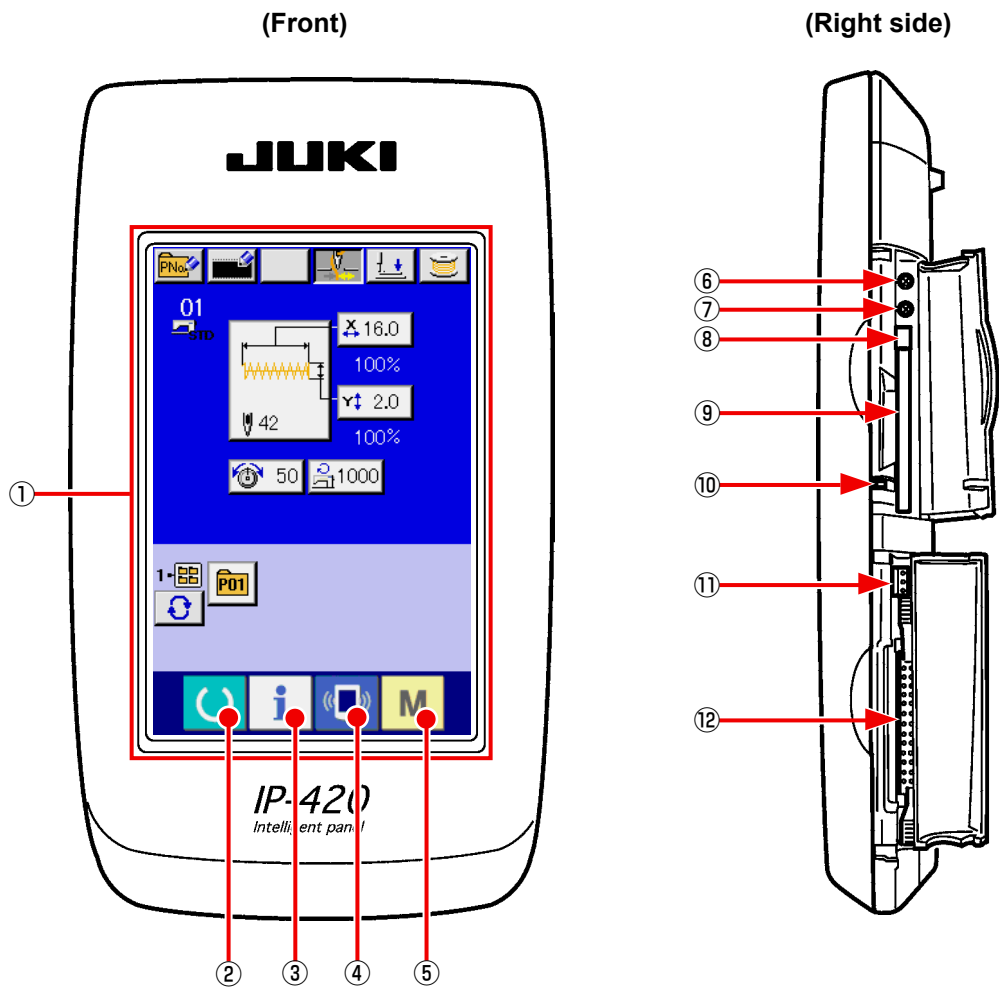

① Touch panel • LCD display section

②  READY key → Changeover of the data input screen and the sewing screen can be performed.

③  INFORMATION key → Changeover of the data input screen and the information screen can be performed

④  COMMUNICATION key → Changeover of the data input screen and the communication screen can be performed.

⑤  MODE key → Changeover of the data input screen and the mode changeover screen which performs various detail settings can be performed.

⑥ Contrast control

⑦ Brightness control

⑧ CompactFlash (TM) eject button

⑨ CompactFlash (TM) slot

⑩ Cover detection switch

⑪ Connector for external switch

⑫ Connector for control-box connection

1-2 Buttons to be used in common

The buttons which perform common operations in each screen of IP-420 are as follows :



CANCEL button

→ This button closes the pop-up screen.
In case of the data change screen, the data being changed can be cancelled.



ENTER button

→ This button determines the changed data.



UP SCROLL button

→ This button scrolls the button or the display in the upward direction.



DOWN SCROLL button

→ This button scrolls the button or the display in the downward direction.



RESET button

→ This button performs the release of error.



NUMERAL INPUT button

→ This button displays ten keys and input of numerals can be performed.



CHARACTER INPUT button

→ This button displays the character input screen.
→ Refer to **“18. NAMING PATTERN” p.46** .



PRESSER DOWN button

→ This button lowers the presser and displays the presser down screen.
To raise the presser, press PRESSER UP button displayed in the presser down screen.



BOBBIN WINDER button

→ This button performs bobbin thread winding.
→ Refer to **“11. WINDING BOBBIN THREAD” p.29** .



2. BASIC OPERATION OF IP-420

LK-1900B is explained as the standard in this Instruction Manual.

① Turn ON the power switch

When the power is turned ON first, the selection screen of the language is displayed. Set the language used. (It is possible to change with memory switch **U239** .)



When ending the selection screen with **CANCEL** button  or **ENTER** button  without selecting the language, the selection screen of the language is again displayed when turning ON the power next.

② Select the pattern No. you desire to sew.

When the power is turned ON , the data input screen is displayed. The shape which is selected at present in the center of the screen is displayed

on **SHAPE SELECTION** button  **A** and the

selection of the sewing shape can be performed when pressing the button. For selecting procedure of the sewing shape, refer to **"4. PERFORMING SEWING SHAPE SELECTION"** p.11 .



For the pattern No., refer to the sewing shape list.

When **READY** key  **B** is pressed, the back color of LCD display is changed to green, and the sewing machine is set to the sewing possible state.



When the presser is raised, be careful that fingers are not caught in the presser since the presser moves after having glowered.



When turning OFF the power without pressing **READY** key, the setting of "Pattern No. ", "XY scale" and "number of max. rotation" are not memorized.

③ Start sewing.

Set the sewing product to the presser portion, and operate the pedal to start the sewing machine, and sewing starts.

* For the screen, refer to **"3. LCD DISPLAY SECTION AT THE TIME OF SEWING SHAPE SELECTION"** p.5 .

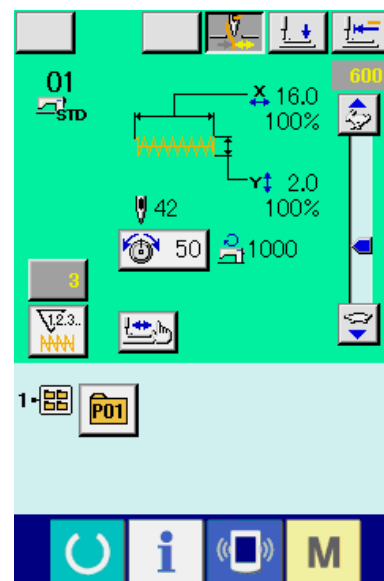
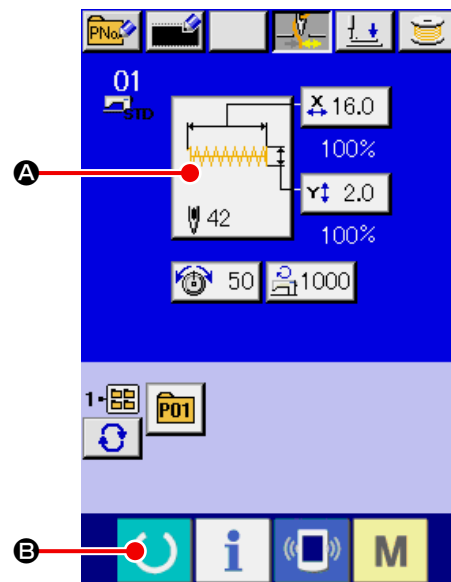



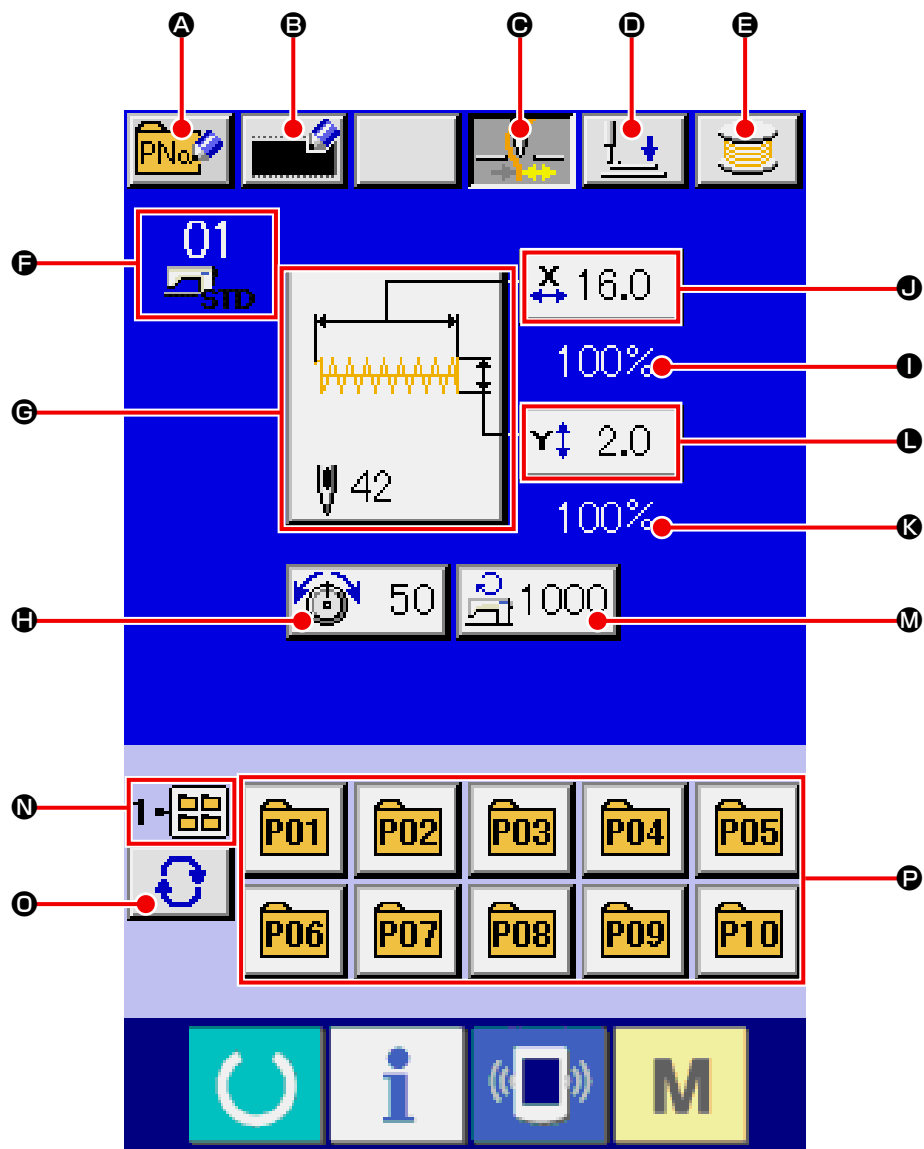

3. LCD DISPLAY SECTION AT THE TIME OF SEWING SHAPE SELECTION

3-1 Sewing shape data input screen



	Button and display	Description
A	PATTERN BUTTON NEW REGISTER button	Pattern button new register screen is displayed. → Refer to “14. PERFORMING NEW REGISTER OF PATTERN BUTTON” p.35 .
B	USERS' PATTERN NEW REGISTER button	Users' pattern new register screen is displayed. → Refer to “13. PERFORMING NEW REGISTER OF USERS' PATTERN” p.34 .
C	THREAD CLAMP button	Effective/ineffective of thread clamp is selected.  : Thread clamp ineffective  : Thread clamp effective * When the prohibition of thread clamp is set with memory switch U035 , the thread clamp button is not displayed.
D	PRESSER DOWN button	Presser can be lowered and the presser down screen is displayed. To raise the presser, press the presser up button which is displayed in the presser down screen.
E	BOBBIN WINDER button	Bobbin thread can be wound. → Refer to “11. WINDING BOBBIN THREAD” p.29 .
F	SEWING SHAPE No. display	Kind and No. of the sewing shape being selected at present are displayed. There are three kinds of sewing shapes below.  : Standard pattern  : Media pattern  : Users' pattern
G	SEWING SHAPE SELECTION button	Sewing shape being selected at present is displayed on this button and when the button is pressed, the sewing shape selection screen is displayed. → Refer to “4. PERFORMING SEWING SHAPE SELECTION” p.11 .
H	NEEDLE THREAD TENSION SETTING button	Needle thread tension value which is set to the pattern data being selected at present is displayed on this button and when the button is pressed, the item data change screen is displayed. → Refer to “6. PERFORMING ITEM DATA CHANGE” p.17 .

	Button and display	Description
①	X ACTUAL SIZE VALUE display	Actual size value in X direction of sewing shape being selected at present is displayed. When the actual size value input is selected by setting memory switch U064 , X actual size value setting button is displayed. → Refer to “6. PERFORMING ITEM DATA CHANGE” p.17 .
②	X SCALE RATE SETTING button	Scale rate in X direction of sewing shape being selected at present is displayed on this button. When the scale input is set to non-selection by setting memory switch U064 , the button goes out and the X scale is displayed. → Refer to “6. PERFORMING ITEM DATA CHANGE” p.17 .
③	Y ACTUAL SIZE VALUE display	Actual size value in Y direction of sewing shape being selected at present is displayed. When the actual size value input is selected by setting memory switch U064 , Y actual size value setting button is displayed. → Refer to “6. PERFORMING ITEM DATA CHANGE” p.17 .
④	Y SCALE RATE SETTING button	Scale rate in Y direction of sewing shape being selected at present is displayed on this button. When the scale input is set to non-selection by setting memory switch U064 , the button goes out and the Y scale is displayed. → Refer to “6. PERFORMING ITEM DATA CHANGE” p.17 .
⑤	MAX. SPEED LIMITATION	Maximum speed limitation which is set at present is displayed on this button and when the button is pressed, the item data change screen is displayed. → Refer to “6. PERFORMING ITEM DATA CHANGE” p.17 .
⑥	FOLDER No. display	Pattern register button which is displayed indicates the folder No. which has been stored.
⑦	FOLDER SELECTION button	Folders to display the patterns are displayed in order.
⑧	PATTERN REGISTER button	PATTERN REGISTER buttons stored in ⑥ FOLDER No. display are displayed. → Refer to “14. PERFORMING NEW REGISTER OF PATTERN BUTTON” p.35 .

	Button and display	Description
A	THREAD CLAMP button	<p>Effective/ineffective of the thread clamp is selected.</p> <p> : Thread clamp ineffective</p> <p> : Thread clamp effective</p> <p>* When the prohibition of thread clamp is set with memory switch U035 , the thread clamp button is not displayed.</p>
B	PRESSER DOWN button	<p>Presser can be lowered and the presser down screen is displayed.</p> <p>To raise the presser, press the presser up button which is displayed in the presser down screen.</p>
C	RETURN TO ORIGIN button	This button returns the presser to the start of sewing and raises the presser.
D	X ACTUAL SIZE VALUE display	Actual size value in X direction of sewing shape being selected is displayed.
E	X SCALE RATE display	Scale rate in X direction of sewing shape being selected is displayed.
F	SEWING SHAPE No. display	<p>Kind and No. of sewing shape being selected at present are displayed.</p> <p>There are three kinds of sewing shapes below.</p> <p> : Standard pattern</p> <p> : Media pattern</p> <p> : Users' pattern</p>
G	SEWING SHAPE display	Sewing shape being selected at present is displayed.
H	SEWING SHAPE Total number of stitches display	Total number of stitches of the sewing shape being selected at present is displayed.
I	NEEDLE THREAD TENSION SETTING button	<p>Needle thread tension value which is set to the pattern data being selected at present is displayed on this button and when the button is pressed, the item data change screen is displayed.</p> <p>→ Refer to “6. PERFORMING ITEM DATA CHANGE” p.17 .</p>
J	COUNTER VALUE CHANGE button	<p>Existing counter value is displayed on this button. When the button is pressed, the counter value change screen is displayed.</p> <p>→ Refer to “12. USING COUNTER” p.30 .</p>
K	COUNTER CHANGE OVER button	<p>Display of sewing counter/No. of pcs. counter can be changed over.</p> <p>→ Refer to “12. USING COUNTER” p.30 .</p>

	Button and display	Description
Ⓐ	STEP SEWING button	Display of sewing counter/No. of pcs. counter can be changed over. → Refer to “7. CHECKING PATTERN SHAPE” p.19 .
Ⓜ	FOLDER No. display	Pattern register button which is displayed indicates the folder No. which has been stored.
Ⓝ	SPEED variable resistor	Number of rotations of the sewing machine can be changed.
Ⓞ	Y ACTUAL SIZE VALUE display	Actual size value in Y direction of sewing shape being selected is displayed.
Ⓟ	Y SCALE RATE display	Scale rate in Y direction of sewing shape being selected is displayed.
Ⓠ	MAX. SPEED LIMITATION display	Maximum speed limitation which is set at present is displayed.
Ⓡ	PATTERN REGISTER button	Pattern register buttons stored in Ⓜ FOLDER No. display are displayed. → Refer to “14. PERFORMING NEW REGISTER OF PATTERN BUTTON” p.35 .

4. PERFORMING SEWING SHAPE SELECTION

① Display the data input screen.

Only in case of the data input screen (blue), the selection of sewing shape is possible. In case of the sewing screen (green), press READY key  and display the data input screen (blue).

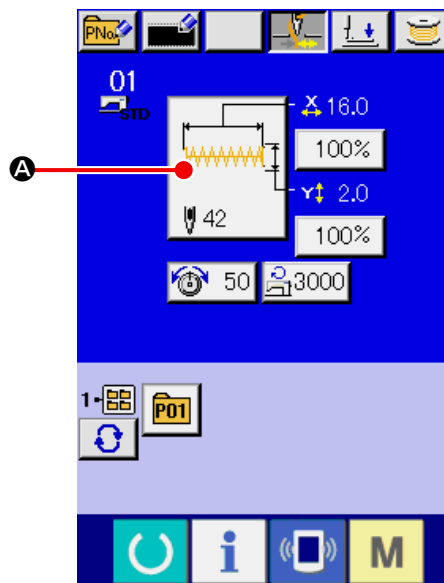

② Call the sewing shape selection screen.

Press SEWING SHAPE button  **A** and the sewing shape selection screen is displayed.

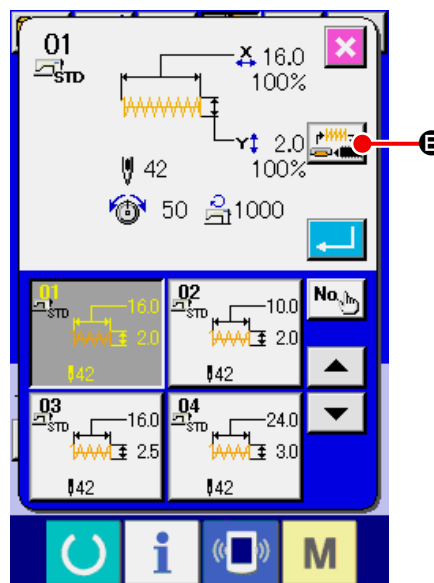

③ Select the kind of sewing shape.

There are three different sewing shapes. Press SEWING SHAPE SELECTION button



④ Determine the kind of sewing shape.

There are three kinds of sewing shapes below.
Select the kind you desire from among them.

Pictograph	Name	Maximum number of patterns
	Standard pattern	1900/1901/1902 : 51 1903 : 50
	Users' pattern	200
	Media pattern	999

Select the sewing shape you desire from SEWING SHAPE SELECTION buttons ③ and press ENTER button  ④.

The sewing shape list screen corresponding to the kind of sewing shape you selected is displayed.

Important
Be sure to use the media that has been formatted with IP-420.
For the formatting procedure of the media, refer to "26-3 Performing format" p.87.

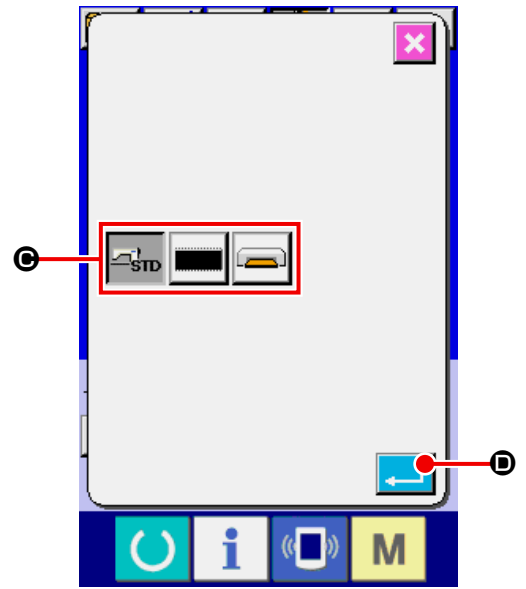

⑤ Select the sewing shape.

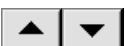
When UP or DOWN SCROLL button  ⑤ is pressed, SEWING SHAPE buttons ⑥ are changed over in order. The description of the sewing shape is displayed in the button. Here, press the SEWING SHAPE button you desire to select. The details of the selected shape is displayed at the upper part of the screen.

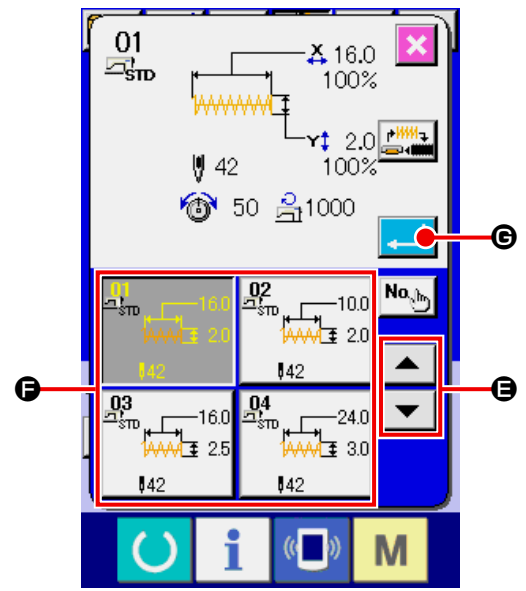



⑥ Determine the sewing shape.

When ENTER button  ⑥ is pressed, the sewing shape is determined and the data input screen is displayed.

When the sewing shape is users' pattern or media pattern the screen as shown on the right side is displayed.

PATTERN No. SELECTION buttons  which have been registered to users' pattern or media pattern are displayed. Press the button of the pattern No. you desire to select.

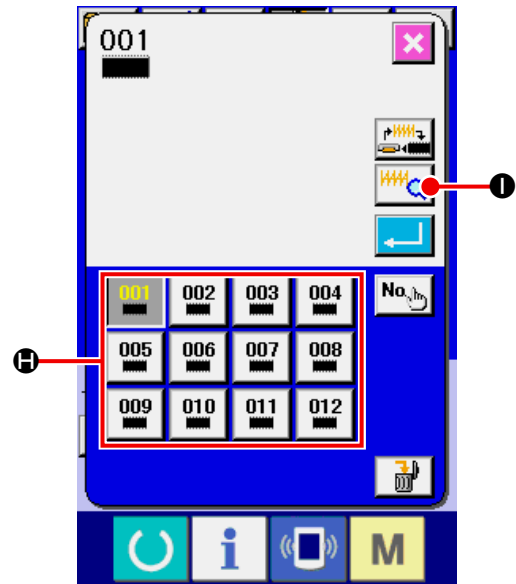

In addition, when you desire to confirm the shape you selected, press VIEWER button   .

Then the viewer screen is displayed and the selected shape is displayed.



When the sewing shape is media pattern the screen as shown on the right side is displayed.

PATTERN No. SELECTION buttons  which have been registered to media pattern are displayed. Press the button of the pattern No. you desire to select.

In addition, when you desire to confirm the shape you selected, press VIEWER button   .

Then the viewer screen is displayed and the selected shape is displayed.

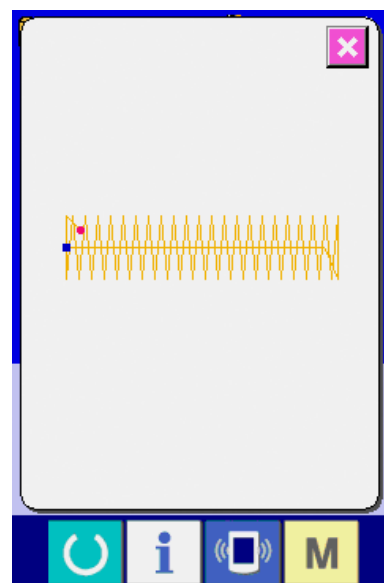
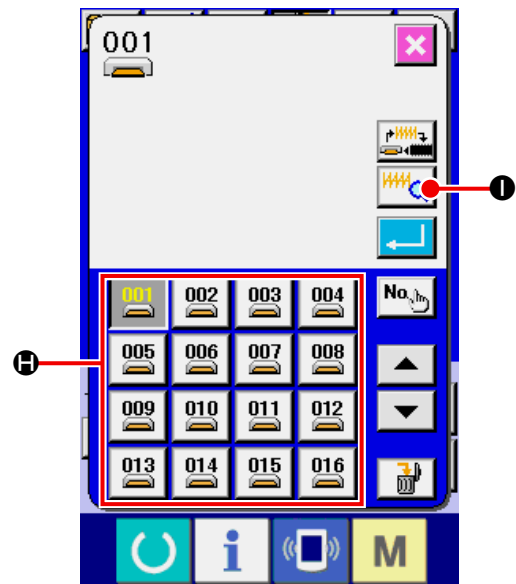

5. SEWING SHAPE LIST

5-1 LK-1900B / LK-1901B / LK-1902B

	No	Stitch diagram	Number of stitches	Sewing size (mm)		(Note 2) No. of presser	No	Stitch diagram	Number of stitches	Sewing size (mm)		(Note 2) No. of presser							
				Lengthwise	Crosswise					Lengthwise	Crosswise								
Large bar-tacking	1 (51)		42	2.0	16	1	Linear bar-tacking		21	0	10	1							
	2												2.0	10	2	28	0	10	2
															3				3
	*3		2.5	16	1	0		25	6										
	*4				4				36	0	25	7							
			7																
	5		28	2.0	10	1		Lengthwise bar-tacking		41	0	25	6						
	*6					2.5							16	2	44	0	35	(Note 3)	
														3					
	7		36	2.0	10	1			23	(Other side) 	28	20	4.0	9					
2						10													
3																			
*8		36	2.5	16	1	24	(Other side) 		36	20	4.0	9							
*9					4							42	20	4.0	9				
		7	10																
*10		64	3.0	24	6	25	(Other side) 		42	20	4.0	9							
11					7			56				20	4.0	9					
		10	10																
Small bar-tacking	11		21	2.5	6	6	Lengthwise linear bar-tacking		18	20	0	11							
	12		28	2.5	6	28							(Other side) 	21	10	0			
	13		36	2.5	6														
Knit goods bar-tacking	14		14	2.0	8	5	29	(Other side) 	20	0									
	15		21	2.0	8	30					(Other side) 	28	20	0					
	16		28	2.0	8														





1. Sewing size shows the dimensions when the scale rate is 100%.





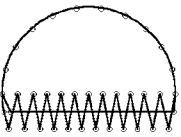
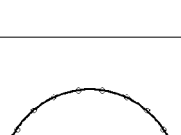

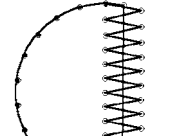
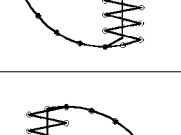
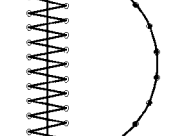
2. Refer the No. of presser to the separate table of presser.

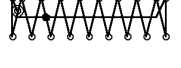
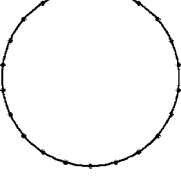
3. For No. 22, process the presser blank for use.

4. Use the patterns with * marks for sewing denim.

5. No.51 is for the machine without tread clamp.

	No	Stitch diagram	Number of stitches	Sewing size (mm)		(Note 2) No. of presser
				Lengthwise	Crosswise	
Semilunar bar-tacking	31		52	7	10	13
	32		63	7	12	13
	33		24	6	10	13
	34		31	6	12	13
	35		48	10	7	14
	36		48	10	7	14
Large bartacking	37		90	3	24	6
						7
Knit goods bartacking	38		28	2	8	5
Round bar-tacking	39		28	Φ12		16
	40		48			

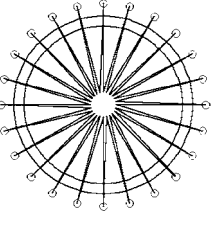
	No	Stitch diagram	Number of stitches	Sewing size (mm)		(Note 2) No. of presser	
				Lengthwise	Crosswise		
Lengthwise bar-tacking	41		29	20	2.5	12	
	42		39	25	2.5	12	
	43		45	25	2.5	12	
	44		58	25	2.5	12	
	45		75	30	2.5	12	
	46		42	30	2.5	12	
	Radial tacking	47		91	Φ8		15
		48		99			
		49		148			
		50		164			

 **Pattern Nos. 41 to 46 are for the optional work clamp foot No. 12. They are different from the lengthwise bar tacking pattern Nos. 23 to 26 in the origin by 5 mm up and down.**

5-2 LK-1903B

Pattern No.	Stitch shape	Number of threads (thread)	Standard sewing size X (mm)	Standard sewing size Y (mm)	Pattern No.	Stitch shape	Number of threads (thread)	Standard sewing size X (mm)	Standard sewing size Y (mm)		
1 - 34		6-6	3.4	3.4	18 - 44		6	3.4	0		
2 - 35		8-8			19 - 45		8				
3		10-10			20		10				
4		12-12			21		12				
5 - 36		6-6			22		16				
6 - 37		8-8			23 - 46		6			0	3.4
7		10-10			24		10				
8		12-12			25		12				
9 - 38		6-6			26 - 47		6-6	3.4	3.4		
10 - 39		8-8			27		10-10				
11		10-10			28 - 48		6-6				
12 - 40		6-6			29		10-10				
13 - 41		8-8			30 - 49		5-5-5	3.0	2.5		
14		10-10			31		8-8-8				
15 - 42		6-6			32 - 50		5-5-5				
16 - 43		8-8			33		8-8-8				
17		10-10									

* The standard sewing sizes of X and Y are when the enlargement/reduction rate is 100%.

Use pattern Nos. 34 to 50 when the button hole is small ($\phi 1.5$ mm or less).

* For the sewing machine provided with the bird's nest preventing and shorter-thread remaining type thread trimmer, pattern numbers 23 to 25, 30 to 33, 46, 49 and 50 have been factory-set, at the time of delivery, so that they are not displayed.

To use those pattern numbers, change the setting so that the memory switch K102 is displayed.

6. PERFORMING ITEM DATA CHANGE

① Display the data input screen.

In case of the data input screen, the change of item data can be changed. In case of the sewing screen (green), press READY key to display the data input screen (blue).

- * Thread tension value can be changed even in the sewing screen.

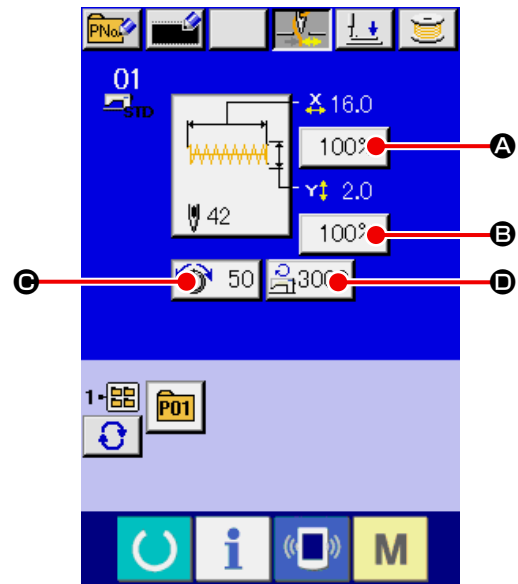

② Display the item data input screen.

When the button of the item data you desire to change is pressed, the item data input screen is displayed.

There are four items of the item data below.

	Item	Input range	Initial value
A	Scale rate in X direction	20 to 200 (%)	100 (%)
B	Scale rate in Y direction	20 to 200 (%)	100 (%)
C	Thread tension	0 to 200	50
D	Max. speed limitation	1900 : 400 to 3200 (sti/min)	3200 (sti/min)
		1901 and 1902 : 400 to 3000 (sti/min)	3000 (sti/min)
		1903 and 1900 double-capacity hook : 400 to 2700 (sti/min)	2700 (sti/min)

- * A Scale rate in X direction and B Scale rate in Y direction can be changed to actual size value input by selection of the memory switch U064 .

- * Max. inputting range of max.limitation speed D and the initial value are determined with memory switch U001 .



CAUTION :

The setting exceeding 100% is dangerous since needle and the cloth presser interferes with each other and needle breakage or the like will occur.

For example, input X scale rate.

Press A to display the item data input screen.

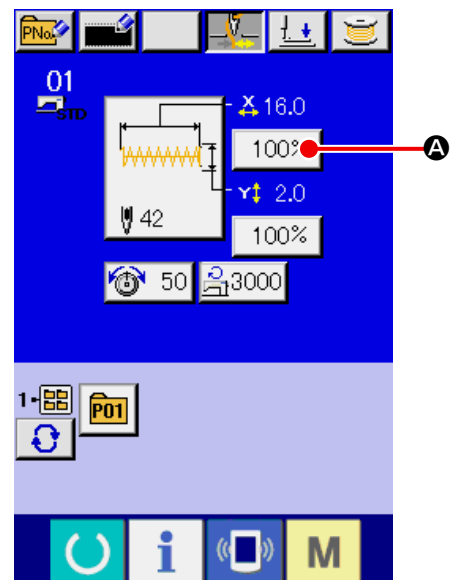

③ **Input the data.**

Input the value you desire with ten keys and +/- keys **E**.



④ **Determine the data.**

When ENTER button  **F** is pressed, the data is determined.

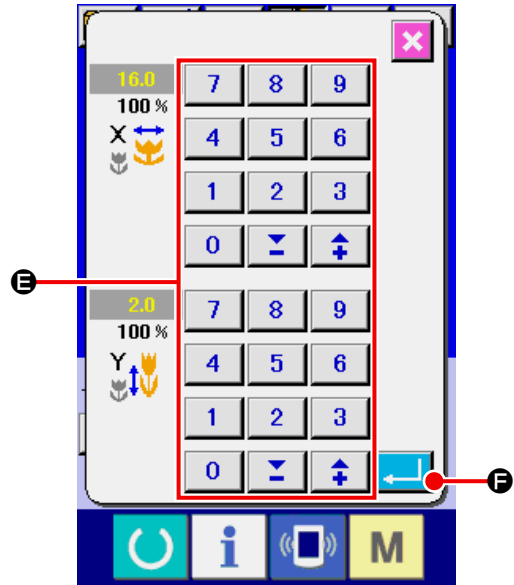
- * For the other item data, the data can be changed by the same operation.
- * X/Y scale or X/Y value of X/Y actual size value can be inputted in one screen.



When turning OFF the power without pressing READY key, the set values of pattern No. , X/Y scale, and number of max. rotation are not memorized.

In the case of adding or deleting the thread tension and the thread tension command for the patterns stored on a medium, the pattern type section display **H** will change from  to .

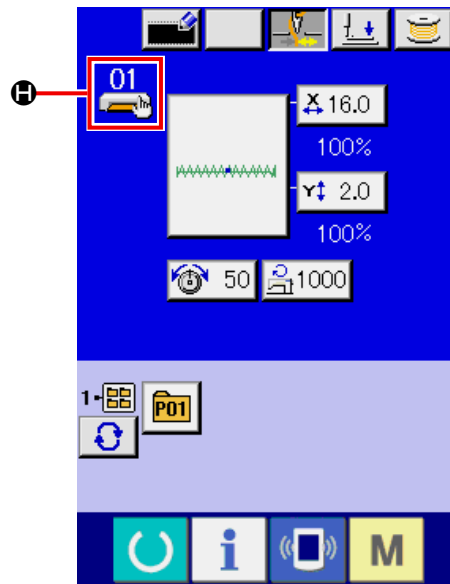

In case of change display **H** , the change confirmation screen is displayed at the time of the change of pattern.

When ENTER button  **I** is pressed, the information on the current pattern is invalidated and the pattern No. is changed.

To store the changed pattern, refer to **“13. PERFORMING NEW REGISTER OF USERS’ PATTERN” p.34** .

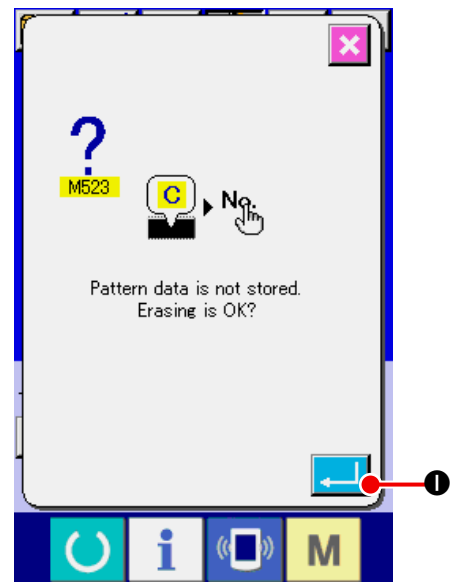

7. CHECKING PATTERN SHAPE



WARNING :

Make sure without fail of the contour of the sewing pattern after selection of the sewing pattern. If the sewing pattern extends outside the work clamp feet, the needle will interfere with the work clamp.

① Display the sewing screen.

Display the data input screen (blue) and press READY key  **A** . Then the back-light of LCD changes to green and sewing is possible.

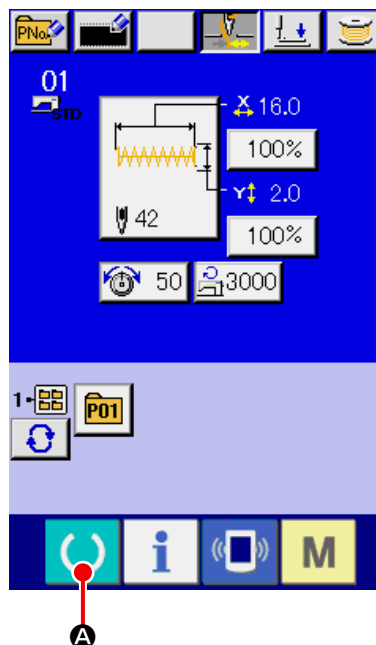

② Display the step sewing screen.

When STEP SEWING button  **B** is pressed, the step sewing screen is displayed.

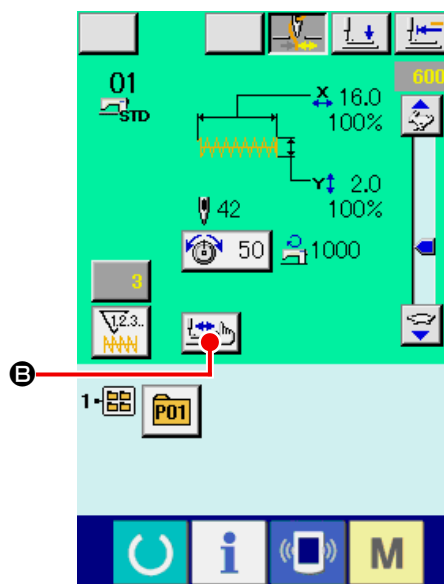

③ Lower the presser with the foot switch.



The work clamp feet do not go up even when the foot switch is detached.

④ Proceed stitching with the presser lowered.

Check the shape with PRESSER BACK button



Ⓒ

and PRESSER FORWARD button



Ⓓ.

When holding pressing the button for a certain time, the presser continues to move even when the button is released.

When you desire to stop, press STOP button



Ⓔ.

When ORIGIN MOVE button



Ⓕ

is pressed, the machine moves to the origin and the screen returns to the sewing screen.

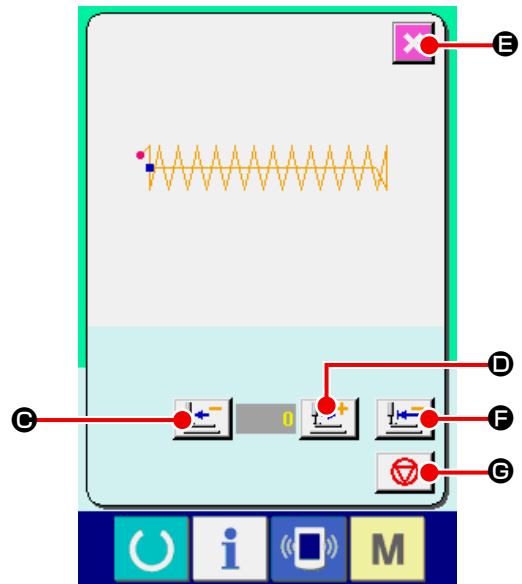

When pressing the presser forward or presser backward button with the needle bar lowered, the presser moves after automatically returning the needle bar to UP position. So, be careful.

⑤ Finish checking the shape.

When CANCEL button



Ⓖ

is pressed, the screen returns to the sewing screen.



When the presser is not in the sewing start position or the sewing end position, press the foot switch.

Then it is possible to sew from the midway of checking.

8. CHANGING THREAD TENSION COMMAND AT EVERY NEEDLE ENTRY POINT

8-1 Adding or changing thread tension command at every needle entry point



① Display the thread tension command change screen



When selecting a standard pattern, user pattern or a pattern stored on a medium, press thread tension button  50 **A** on the sewing screen to display the thread tension setting screen. Press THREAD TENSION COMMAND CHANGE button  **B** on the thread tension setting screen and the thread tension command change screen is displayed.



The sewing machine does not start even when the foot switch is depressed under this mode.

② Specify the command position you desire to change.

Specify the position you desire to add the thread tension command or that you desire to change the thread tension command value with ONE STITCH BACKWARD button  **C** or ONE STITCH FORWARD button  **D** in the state that the presser is lowered.



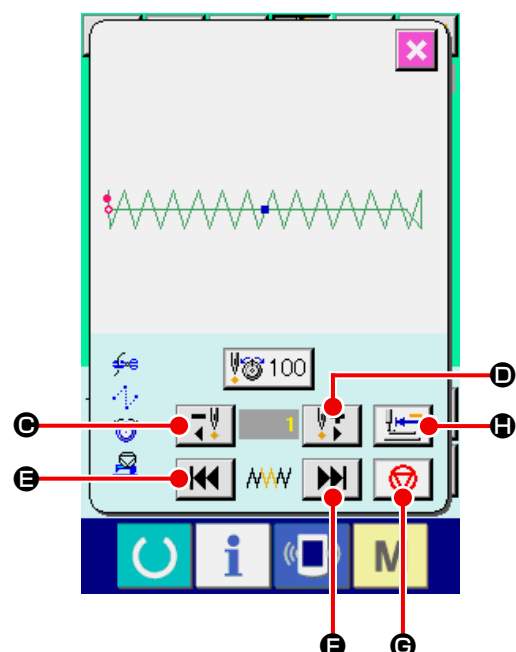
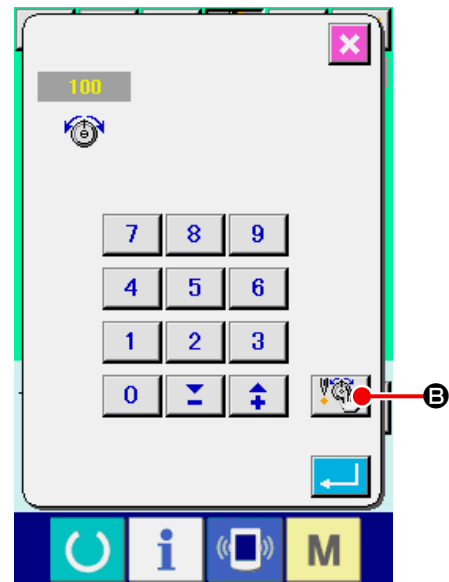
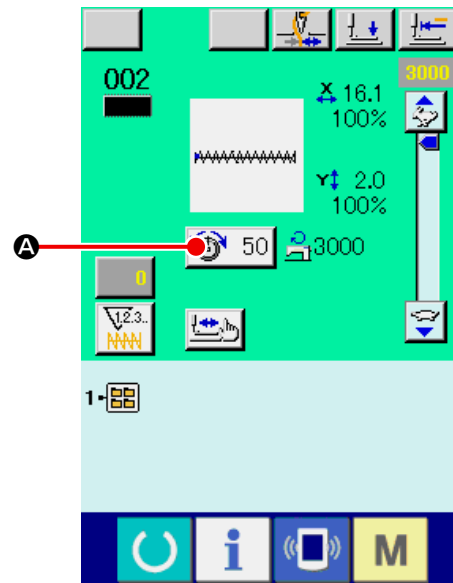

In addition, the machine moves to the needle entry point where the front or rear thread tension command exists with  **E** or  **F**. When you desire to stop the move, press STOP button  **G**.

When ORIGIN MOVE button  **H** is pressed, the machine moves to the origin.

The value to be displayed is the absolute value (thread tension value + thread tension command value).



③ **Input thread tension command value.**

When COMMAND INPUT button  50  is pressed, the thread tension increase/decrease value input screen is displayed. Input the value you desire with TEN keys and +/- keys . When ENTER button   is pressed, the data is determined.

* For the standard patterns, the thread tension command entry button is displayed only at the position where the thread tension command already exists.

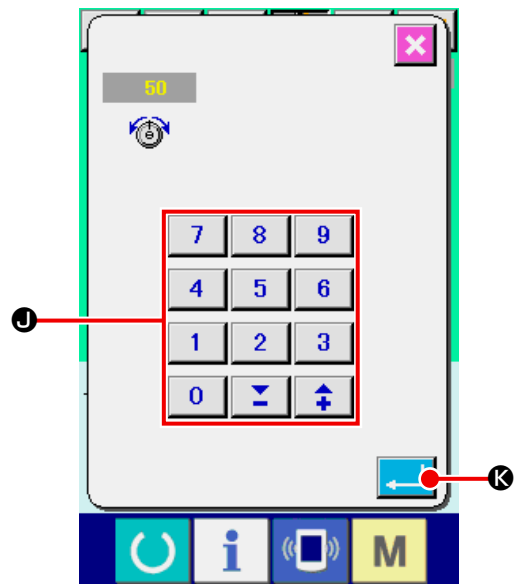
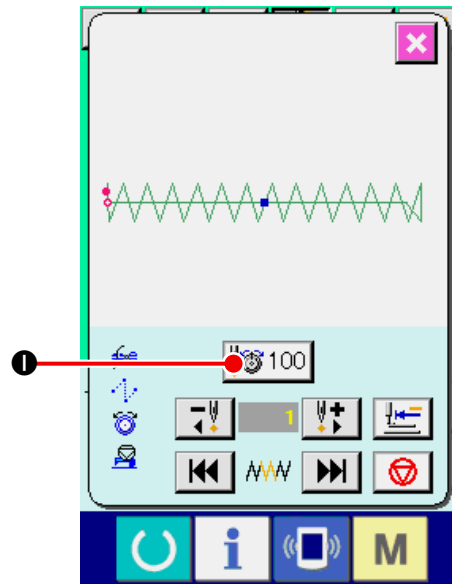

8-2 Deleting thread tension command at every needle entry point

① Display the thread tension command change screen.

When selecting a standard pattern, user pattern or a pattern stored on a medium, press thread tension button **A** on the sewing screen to display the thread tension setting screen.

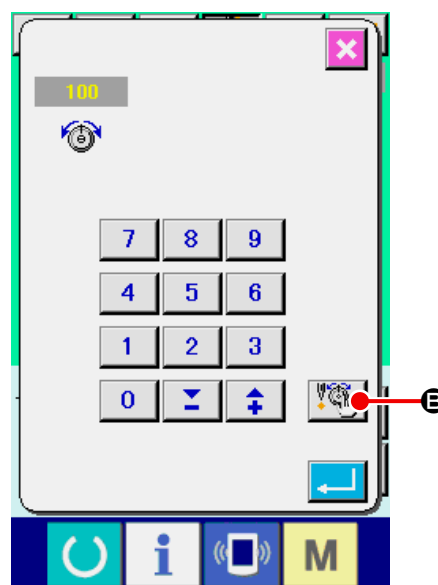
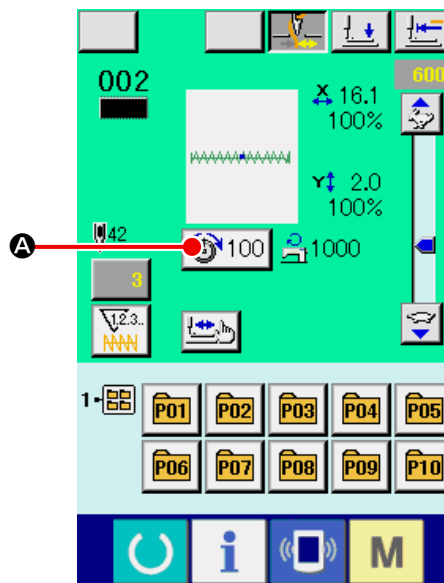

When THREAD TENSION COMMAND CHANGE button **B** on the thread tension setting screen is pressed, the thread tension command change screen is displayed.





② **Designate the command position desired to be deleted.**

Specify the command position you desire to delete with ONE STITCH BACKWARD button 

or ONE STITCH FORWARD button  in the state that the presser is lowered.

In addition, the machine moves to the needle entry point where the front or rear thread tension command exists with  or . When you desire to stop the move, press STOP button 

When ORIGIN MOVE button  is pressed, the machine moves to the origin.

When the present needle entry point exists on the thread tension command, COMMAND DELETE button  is displayed.

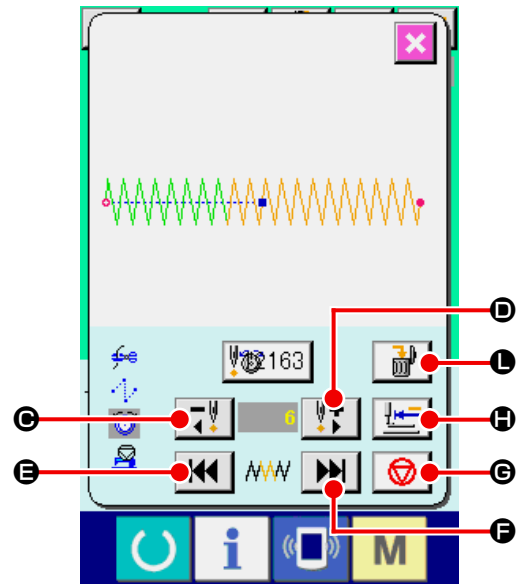

③ **Delete the thread tension command.**

When COMMAND DELETE button  is pressed, the command delete screen is displayed.

When ENTER button  is pressed, the command is deleted.

* For the standard patterns, the thread tension command cannot be deleted.

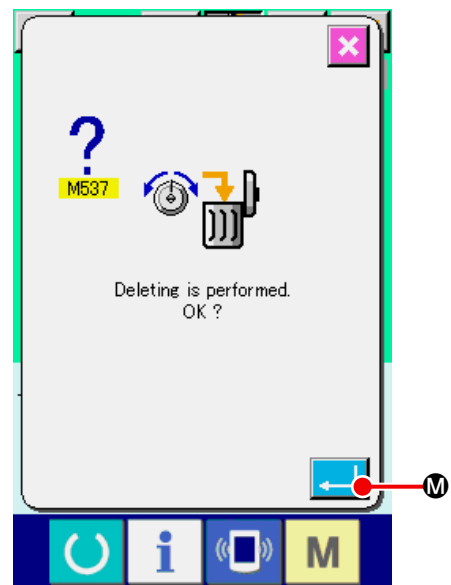

9. PERFORMING RELEASE OF GREASE-UP ERROR

When the number of stitches of grease-up exceeds 100 million stitches or more, E220, grease-up warning occurs when turning ON the power.

Clear the number of stitches of grease-up with memory switch **U245**, grease-up error clear after replenishing grease. E220 is displayed each time turning ON the power until clearing is performed.

When the number of stitches of grease-up exceeds 120 million stitches or more, E221, grease-up error occurs when READY key is pressed. When E221 occurs, it is not possible to sew. Clear the number of stitches of grease-up with memory switch **U245**, grease-up error clear after replenishing grease

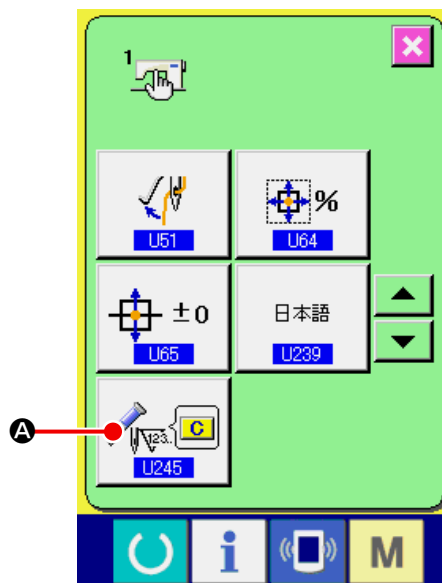

① Display the memory switch data list screen.

Display the memory switch data list screen and select button **A** of **U245** Grease-up error clear. The grease-up error clear screen is displayed.

② Clear the number of stitches of grease-up.

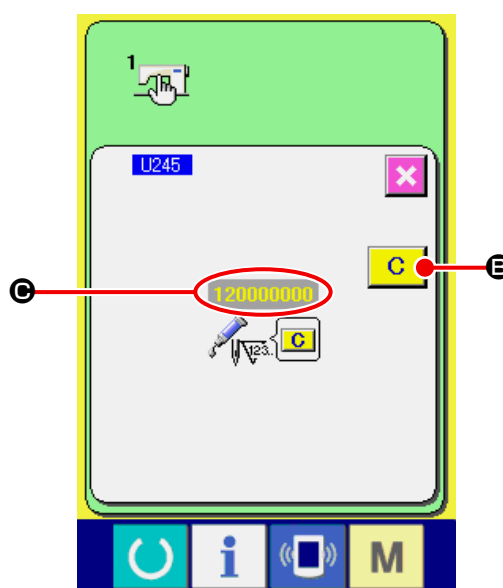

When CLEAR button **C** **B** is pressed, the pop-up is closed and the number of stitches of grease-up can be cleared.



1. Error code E220 or E221 is displayed again unless NUMBER OF STITCHES **C** is changed to "0" after replenishing the designated places with grease. When E221 is displayed, the sewing machine fails to operate. So, be careful.
2. Be sure to turn the power OFF before applying grease.

10. USING TEMPORARY STOP

When the panel temporary stop button is selected with memory switch **L031**, TEMPORARY STOP button  **A** is displayed on the sewing screen.

When the TEMPORARY STOP button  **A** is pressed during sewing, the sewing machine can be stopped. At this time, the error screen is displayed to inform that the TEMPORARY STOP button  **A** is pressed.



Perform the same operation when the external switch is used for the temporary stop.

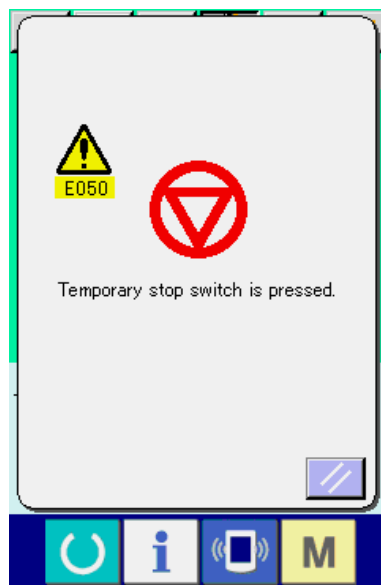
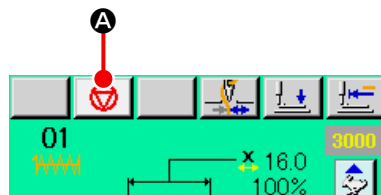



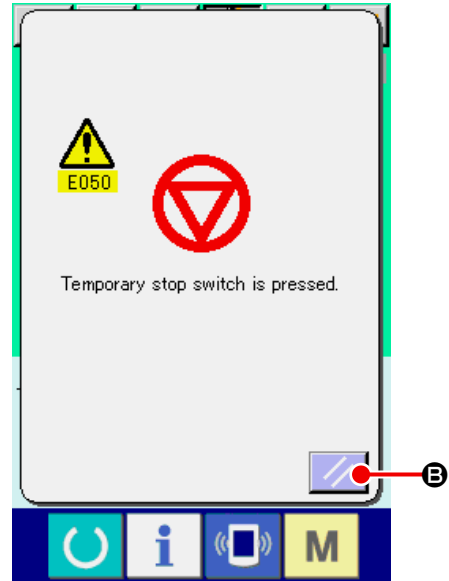

10-1 To continue performing sewing from some point in sewing

① Release the error.

Press RESET button  **B** to release the error.



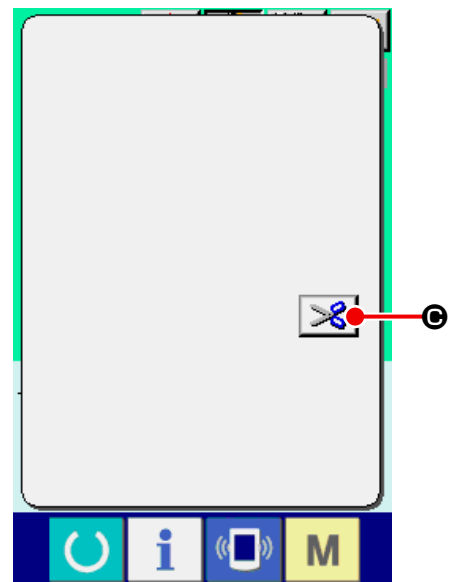

② Perform thread trimming.

Press THREAD TRIM button  **C** to perform
When thread trimming has been performed,
FEED BACK button  **D**, FEED FORWARD
button  **E** and RETURN TO ORIGIN button
 **F** are displayed on the screen.



③ Adjust the presser to the re-sewing position.

When FEED BACK button  **D** is pressed,
the presser returns stitch and by stitch and when
FEED FORWARD button  **E** is pressed, it
advances stitch by stitch. Move the presser to the
re-sewing position.

④ Re-start the sewing

When the pedal is depressed, sewing starts
again.

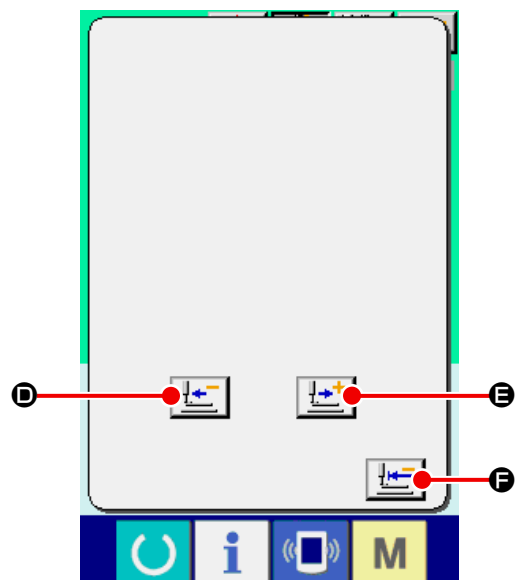

10-2 To perform re-sewing from the start

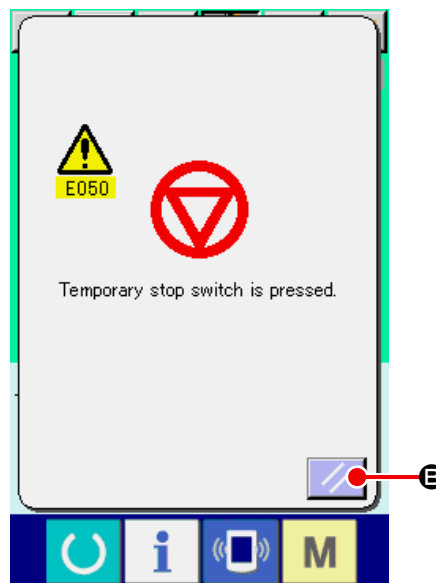

① Release the error.

Press RESET button  **B** to release the error.



② Perform thread trimming.

Press THREAD TRIM button  **C** to perform thread trimming.

When thread trimming is performed, FEED BACK button  **D**, FEED FORWARD button  **E** and RETURN TO ORIGIN button  **F** are displayed on the screen.

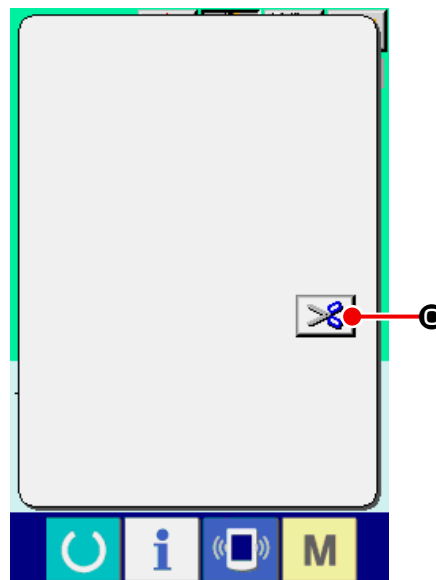

③ Return to the origin.

When RETURN TO ORIGIN button  **F** is pressed, the pop-up is closed, the sewing screen is displayed and the machine returns to the position of the start of sewing.

④ Perform again the sewing work from the start

When the pedal is depressed, sewing starts again.

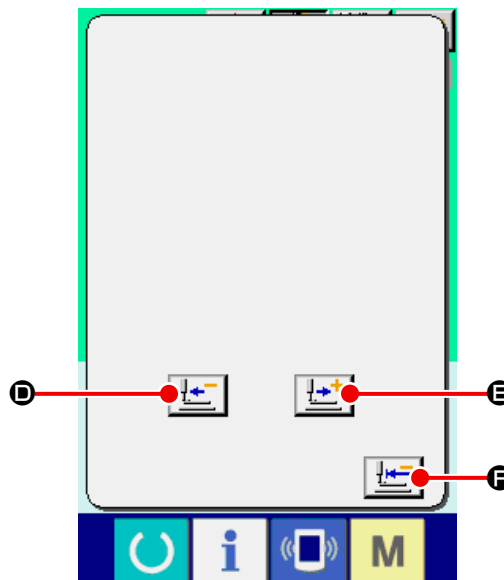

11. WINDING BOBBIN THREAD

Pass the thread to wind bobbin thread as shown in the figure on the right side.

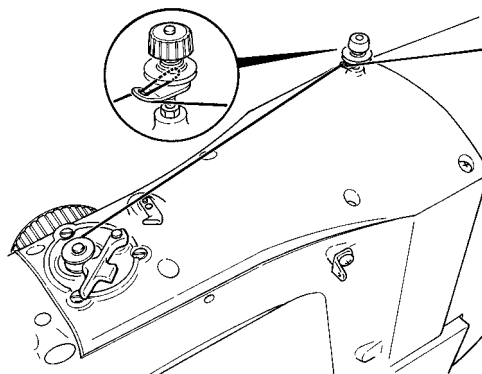

① **Display the bobbin winding screen.**

Press BOBBIN WINDER button  **A** in the data input screen (blue) and the bobbin winding screen is displayed.

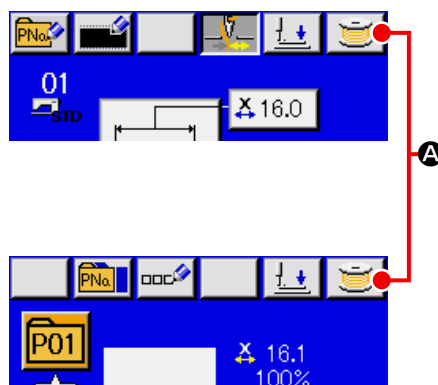

② **Start bobbin winding.**

Depress the start pedal, and the sewing machine rotates and starts winding bobbin thread.

③ **Stop the sewing machine.**

Press STOP button  **B** and the sewing machine stops and returns to the normal mode. Or, depress the start pedal again during winding bobbin and the sewing machine stops while the bobbin thread winding mode stays as it is. Depress the start pedal again and the bobbin winding starts again. Use this way when winding bobbin thread around plural bobbins.

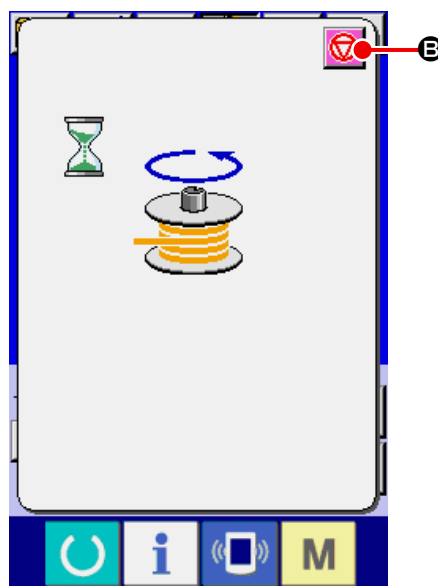

Bobbin winder does not work immediately after turning ON the power or moving from the main unit input.

Perform the bobbin winding after setting pattern No. or the like, pressing READY key , and making the sewing screen display.



12. USING COUNTER

12-1 Setting procedure of the counter

① Display the counter setting screen.

When **M** key is pressed in the data input screen, COUNTER SETTING button  **A** is displayed. When this button is pressed, the counter setting screen is displayed.

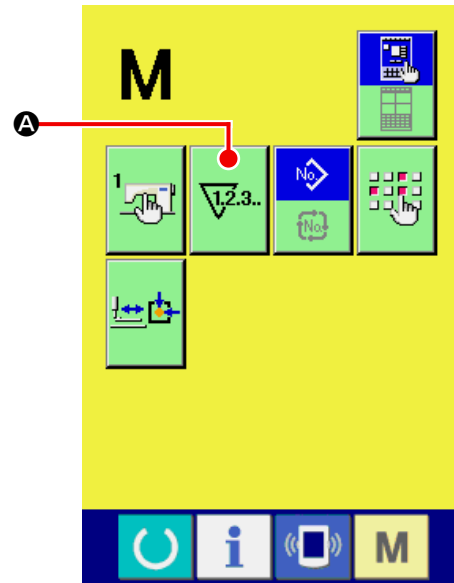

② Selection of kinds of counters

This sewing machine has three different counters; i.e., the sewing counter, No. of pcs. counter and bobbin counter. When SEWING COUNTER TYPE

SELECT button  **B**, NO. OF PCS. COUNT-

ER TYPE SELECT button  **C** or BOBBIN

COUNTER TYPE SELECT button  **D** is

pressed, the corresponding counter type select screen is displayed. On this screen, the counter type can be selected individually.

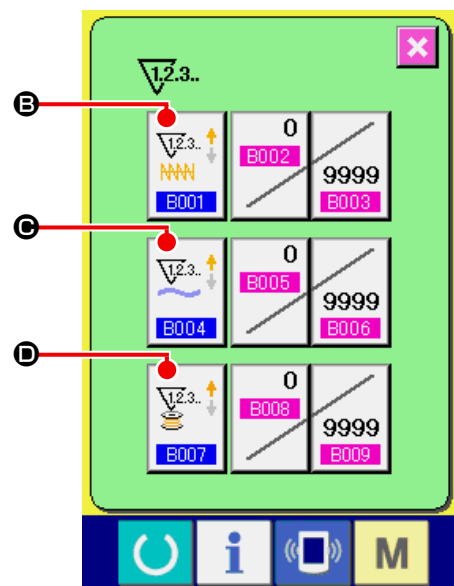

[Sewing counter]

UP counter :



Every time the sewing of one shape is performed, the existing value is counted up. When the existing value is equal to the set value, the count-up screen is displayed.

DOWN counter :



Every time the sewing of one shape is performed, the existing value is counted down. When the existing value is reached to "0", the count-up screen is displayed.

Counter disuse:



The sewing counter does not count a finished shape even when the machine has sewn the shape. The counter screen of the sewing counter is not displayed.

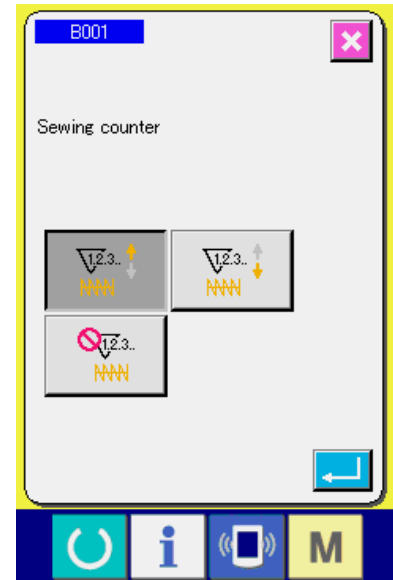

[No. of pcs. Counter]

UP counter :



Every time one combination sewing is performed, the existing value is counted up. When the existing value is equal to the set value, the count-up screen is displayed.

DOWN counter :



Every time one combination sewing is performed, the existing value is counted down. When the existing value is reached to "0", the count-up screen is displayed.

Counter disuse:



The No. of pcs. counter does not perform counting. The counter screen of the No. of pcs. counter is not displayed.

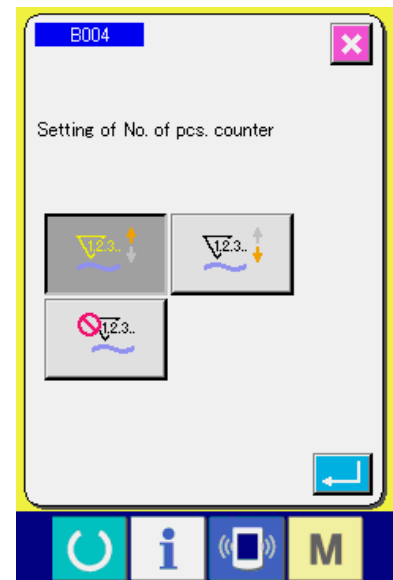

[Bobbin counter]

UP counter :



The counter increases the existing value by one every time the machine has sewn 10 stitches. When the existing value is equal to the set value, the count-up screen is displayed.

DOWN counter :



The counter decreases from the existing value by one every time the machine has sewn 10 stitches. When the existing value is reached to "0", the count-up screen is displayed.

Counter disuse:



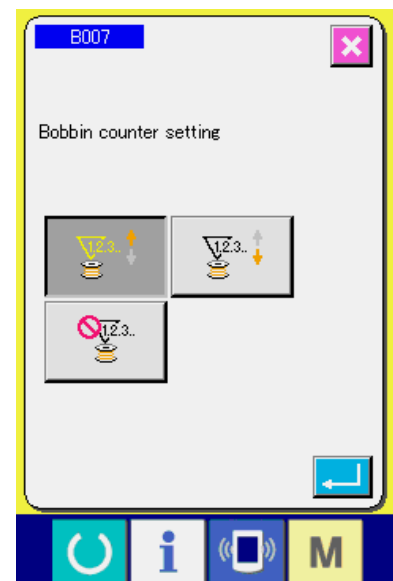

The bobbin counter does not perform counting. The counter screen of the bobbin counter is not displayed.

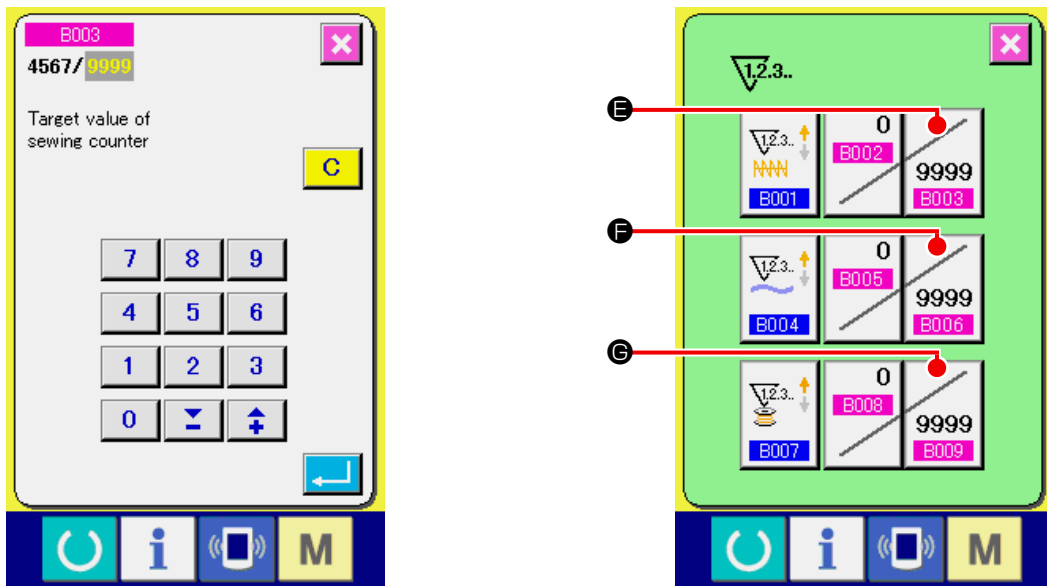

③ Change of counter set value







Press button  **E** for the sewing counter, button  **F** for the No. of pcs. counter or button  **G** for the bobbin counter to display the corresponding counter set value input screen.

Here, input the set value.

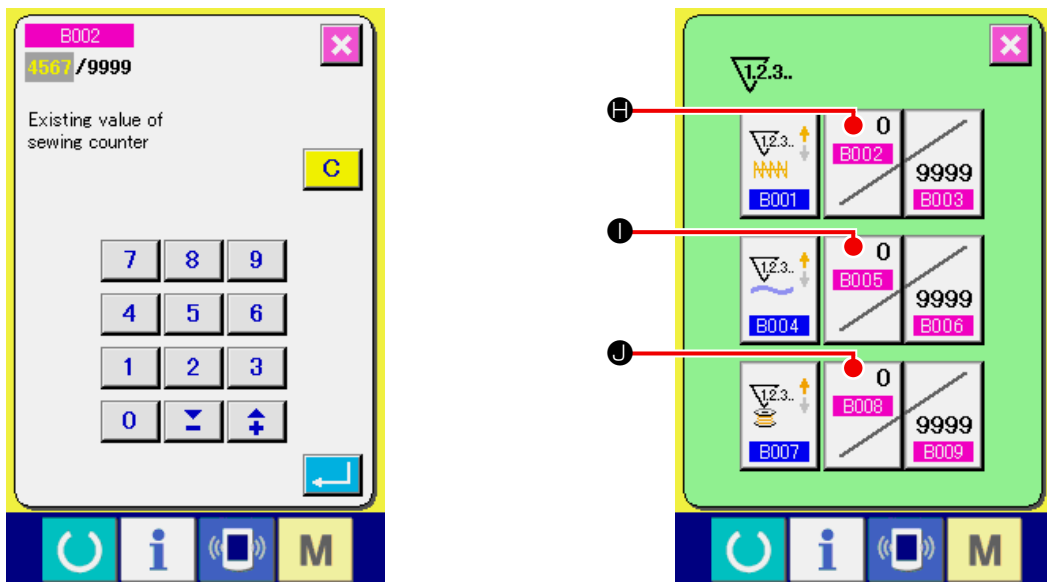
When "0" is inputted in the set value, the display of count-up screen is not performed.

④ Change of counter existing value



Press button  **H** for the sewing counter, button  **I** for the No. of pcs. counter or button  **J** for the bobbin counter to display the corresponding counter current value input screen.

Here, input the existing value.

12-2 Count-up releasing procedure

When the count-up condition is reached during sewing work, the count-up screen is displayed and the buzzer beeps. Press CLEAR button **C** **H** to reset the counter and the screen returns to the sewing screen. Then the counter starts counting again.

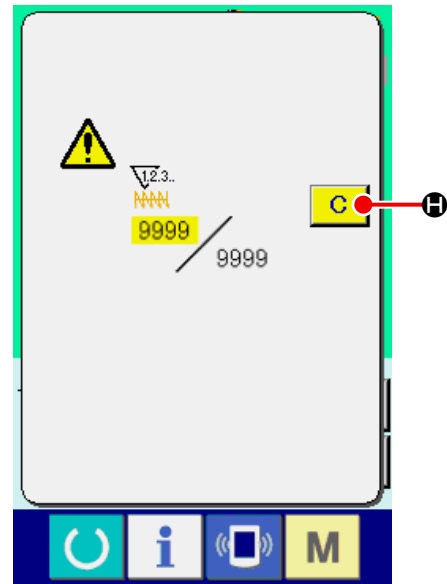

12-3 How to change the counter value during sewing

① Display the counter value change screen.

When you desire to revise the counter value during sewing work due to the mistake or the like, press COUNTER VALUE CHANGE button **0**

I on the sewing screen. The counter value change screen is displayed.

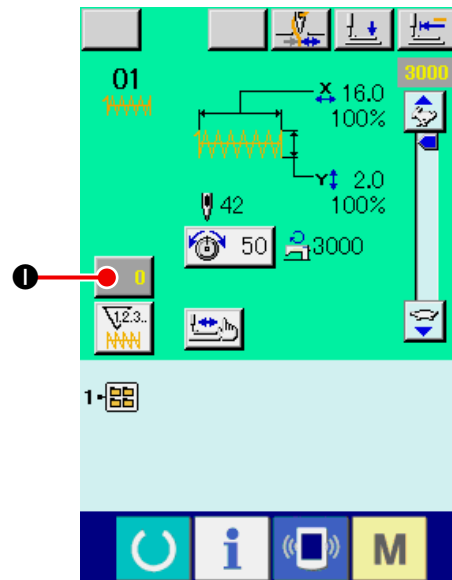

② Change the counter value.

Input the value you desire with ten keys, or + or - key **J**.

③ Determine the counter value.

When ENTER button **L** is pressed, the data is determined.

When you desire to clear the counter value, press CLEAR button **C** **K**.

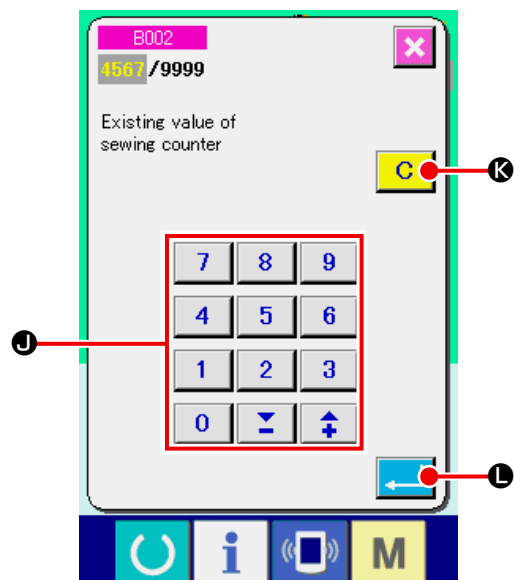

13. PERFORMING NEW REGISTER OF USERS' PATTERN

① **Display the data input screen.**

Only in case of the data input screen (blue), new register of the pattern can be performed. In case of the sewing screen (green), press READY key  to display the data input screen (blue).

② **Call the new register of users' pattern screen.**

Press NEW REGISTER button  **A** and the new register of users' pattern screen is displayed.

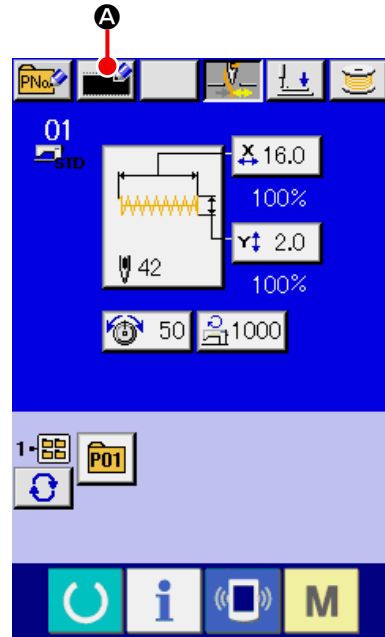

③ **Input the users' pattern No.**

Input the users' pattern No. you desire to newly register with the ten keys **B**. When the users' pattern No. which has been already registered is inputted, press ENTER button  **E** and E403 is displayed, Then select the users' pattern No. which has not been registered. New register to the users' pattern No. which has been already registered is prohibited.

It is possible to retrieve the users' pattern No. which has not been registered with the + or - button  (**C** and **D**).

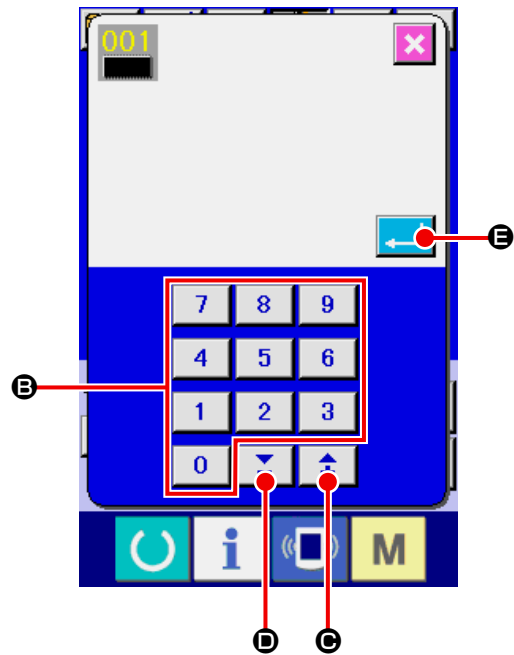

④ **Determine the users' pattern No.**

Press ENTER button  **E** to determine the users' pattern No. to be newly registered and the data input screen at the time of users' pattern selection is displayed.

14. PERFORMING NEW REGISTER OF PATTERN BUTTON

① Display the data input screen.

Only in case of the data input screen (blue), new register of the pattern button can be performed. In case of the sewing screen (green), press READY key  to display the data input screen (blue).

② Call the new register of pattern button screen.

Press NEW REGISTER button  **A** and the new register of pattern button screen is displayed.

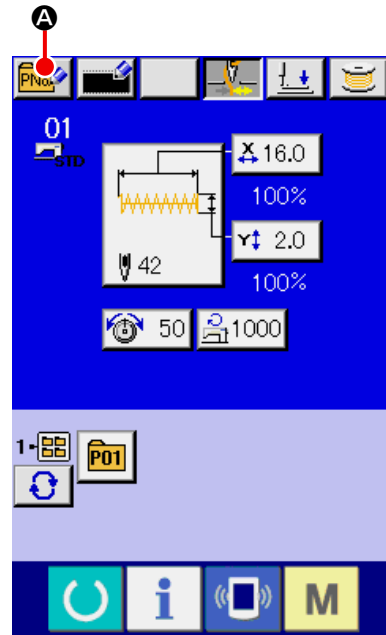

③ Input the pattern button No.

Input the pattern button No. you desire to newly register with the ten keys **B**. When the pattern No. which has been already registered is inputted, the sewing shape which has been already registered is displayed in the upper part of the screen. Select the pattern button No. which is not displayed and has not been registered. New register to the pattern button No. which has been already registered is prohibited.

It is possible to retrieve the pattern button No. which has not been registered with the + or - button  (**C** and **D**).

④ Select the folder to be stored.

It is possible for the pattern buttons to be stored in one of the five folders. As many as 10 pattern buttons can be stored for one folder. The folder to store the button can be selected with FOLDER SELECTION button **E**. The folder in which 10 pattern buttons have been stored is not displayed.

The folder to store the button can be selected with FOLDER SELECTION button **E**. The folder in which 10 pattern buttons have been stored is not displayed.

⑤ Determine the pattern No.

Press ENTER button  **F** to determine the pattern button No. to be newly registered and the data input screen at the time of pattern button selection is displayed.

* When registering the users' pattern to the pattern button, the comment registered to the users' pattern is not copied.

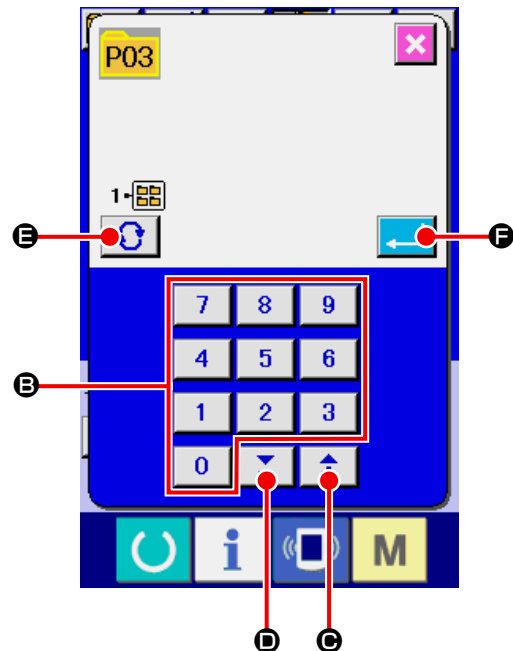



When the sewing screen is displayed and pressing P1 to P50 keys, the presser comes down. Be careful not to allow the fingers to be caught in it.

15. LCD DISPLAY SECTION AT THE TIME OF PATTERN BUTTON SELECTION

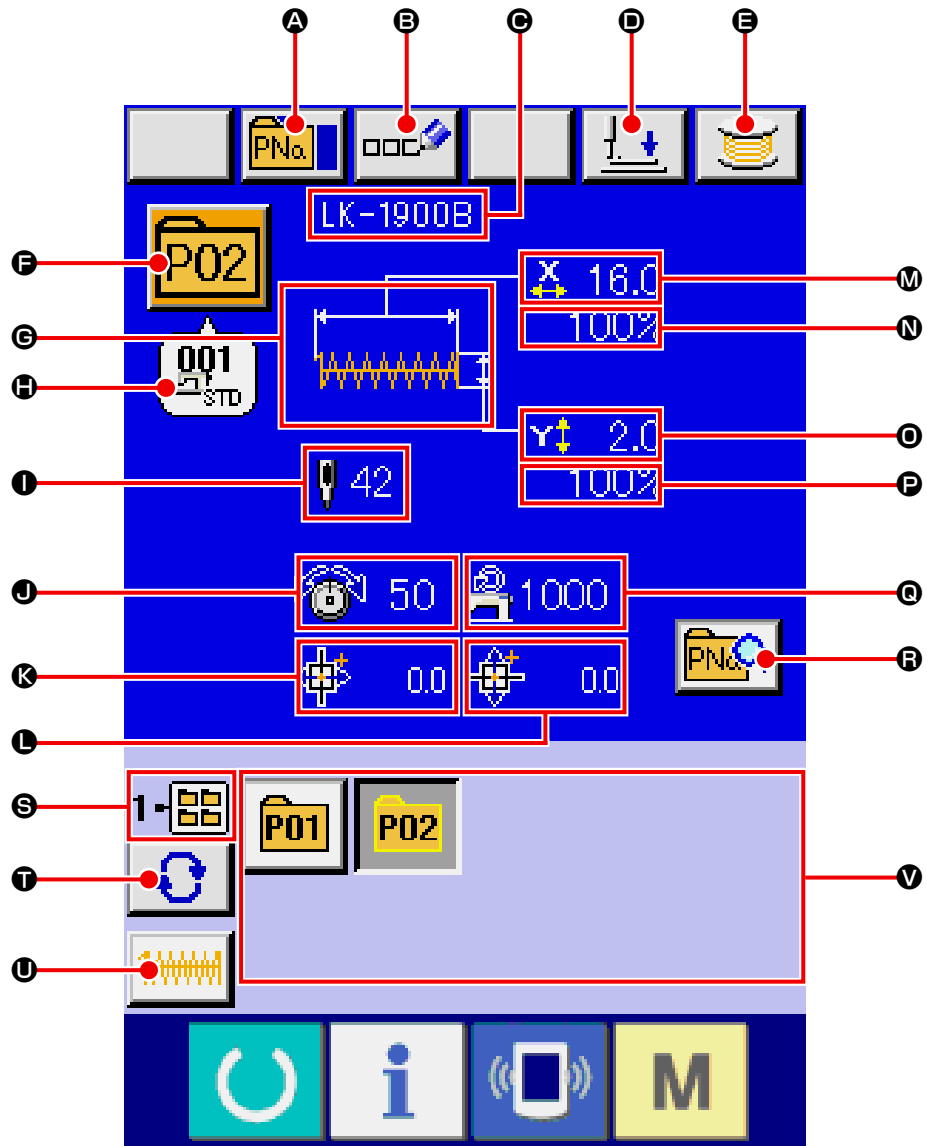
15-1 Pattern button data input screen



	Button and display	Description
A	PATTERN BUTTON COPY button	Pattern button copy screen is displayed. → Refer to “19. COPYING PATTERN BUTTON” p.47 .
B	PATTERN BUTTON NAME SETTING button	Pattern button name input screen is displayed. → Refer to “18. NAMING PATTERN” p.46 .
C	PATTERN BUTTON NAME display	Character which is registered to the pattern button No. being selected is displayed.
D	PRESSER DOWN button	Presser can be lowered and the presser down screen is displayed. To raise the presser, press the presser up button displayed in the presser down screen.
E	WINDING BOBBIN button	Bobbin thread can be wound. → Refer to “11. WINDING BOBBIN THREAD” p.29 .
F	PATTERN BUTTON No. display	Pattern button No. being selected at present is displayed on this button and when the button is pressed, the pattern button No. selection screen is displayed. → Refer to “16. PERFORMING PATTERN BUTTON No. SELECTION” p.42 .
G	SEWING SHAPE	Sewing shape which is registered to the pattern button No. being selected is displayed.
H	SEWING SHAPE No.	Kind of shape and sewing shape No. of the sewing shape which is registered to the pattern button No. being selected are displayed. There are three kinds of sewing shapes below.  : Standard pattern  : media pattern  : Users' pattern
I	TOTAL No. OF STITCHES	Total number of stitches of the pattern which is registered to the pattern button No. during sewing is displayed.

	Button and display	Description
Ⓜ	THREAD TENSION display	Thread tension value which is registered to the pattern button No. being selected is displayed.
Ⓝ	TRAVEL AMOUNT IN X DIRECTION display	Travel amount in X direction which is registered to the pattern button No. being selected is displayed.
Ⓛ	TRAVEL AMOUNT IN Y DIRECTION display	Travel amount in Y direction which is registered to the pattern button No. being selected is displayed.
Ⓜ	X ACTUAL SIZE VALUE display	X actual size value which is registered to the pattern button No. being selected is displayed.
Ⓝ	X SCALE RATE display	X scale rate which is registered to the pattern button No. being selected is displayed.
Ⓛ	Y ACTUAL SIZE VALUE display	Y actual size value which is registered to the pattern button No. being selected is displayed.
Ⓟ	Y SCALE RATE display	Y scale rate which is registered to the pattern button No. being selected is displayed.
Ⓞ	MAX. SPEED LIMITATION	Maximum speed limitation which is registered to the pattern button No. being selected is displayed.
Ⓡ	Pattern button edit screen is displayed.	Pattern button edit screen is displayed. → Refer to “17. CHANGING CONTENTS OF PATTERN BUTTON” p.44 .
Ⓢ	FOLDER No. display	Folder No. in which the displayed pattern buttons are stored is displayed.
Ⓣ	FOLDER SELECTION button	Folders to display the pattern button are displayed in order.
Ⓤ	SEWING SHAPE SELECTION DATA INPUT SCREEN DISPLAY button	Sewing shape data input screen is displayed. → Refer to “3-1 Sewing shape data input screen” p.5 .
Ⓥ	PATTERN button	Pattern buttons stored in Ⓢ Folder No. are displayed. → Refer to “14. PERFORMING NEW REGISTER OF PATTERN BUTTON” p.35 .

15-2 Sewing screen

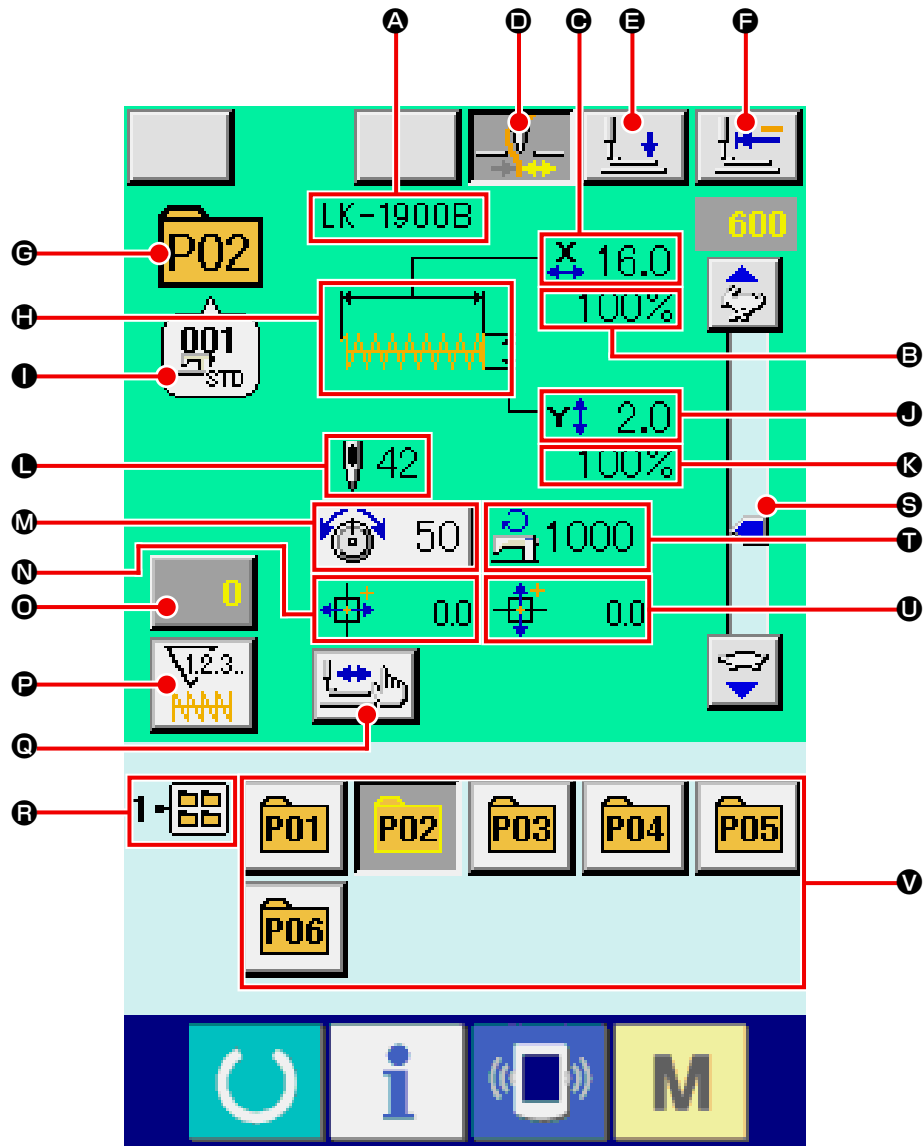

	Button and display	Description
Ⓐ	PATTERN BUTTON NAME display	Character which is registered to the pattern button No. being sewn is displayed.
Ⓑ	X SCALE RATE display	Scale rate in X direction which is registered to the pattern button No. being sewn is displayed.
Ⓒ	X ACTUAL SIZE VALUE display	Actual size value in X direction which is registered to the pattern button No. being sewn is displayed.
Ⓓ	THREAD CLAMP button	<p>Effective/ineffective of thread clamp is selected.</p> <p> : Thread clamp ineffective</p> <p> : Thread clamp effective</p> <p>* When the prohibition of thread clamp is set with memory switch U035 , the thread clamp button is not displayed.</p>
Ⓔ	PRESSER DOWN button	<p>Presser can be lowered and the presser down screen is displayed.</p> <p>To raise the presser, press the presser up button displayed in the presser down screen</p>
Ⓕ	RETURN TO ORIGIN button	Presser is returned to the start of sewing and is raised.
Ⓖ	PATTERN No. display	Pattern button No. being sewn is displayed.
Ⓕ	SEWING SHAPE display	Sewing shape being sewn is displayed.
Ⓖ	SEWING SHAPE No. display	Kind of sewing and sewing shape No. which are registered to the pattern being sewn are displayed.
Ⓙ	Y ACTUAL SIZE VALUE display	Actual size value in Y direction which is registered to the pattern button No. being sewn is displayed.
Ⓚ	Y SCALE RATE display	Scale rate in Y direction which is registered to the pattern button No. being sewn is displayed.
Ⓛ	TOTAL No. OF STITCHES OF SEWING SHAPE display	Total number of stitches of sewing shape which is registered to the pattern button No. being sewn is displayed.
Ⓜ	NEEDLE THREAD TENSION SETTING button	<p>Needle thread tension value which is set to the pattern data being selected at present is displayed on this button and when the button is pressed, the item data change screen is displayed.</p> <p>→ Refer to “6. PERFORMING ITEM DATA CHANGE” p.17 .</p>

	Button and display	Description
N	TRAVEL AMOUNT IN X DIRECTION display	Travel amount in X direction which is registered to the pattern button No. being sewn is displayed.
O	COUNTER VALUE CHANGE button	Existing counter value is displayed on this button. When the button is pressed, the counter value change screen is displayed. → Refer to “12. USING COUNTER” p.30 .
P	COUNTER CHANGEOVER button	Display of sewing counter/No. of pcs. counter can be changed over. → Refer to “12. USING COUNTER” p.30 .
Q	STEP SEWING button	The step sewing screen is displayed. Checking the pattern shape can be performed. → Refer to “7. CHECKING PATTERN SHAPE” p.19 .
R	FOLDER No. display	Folder No. in which the displayed pattern register buttons are stored is displayed.
S	SPEED variable resistor	Number of revolutions of the sewing machine can be changed.
T	MAX. SPEED LIMITATION display	Maximum speed limitation which is registered to the pattern button No. being sewn is displayed.
U	TRAVEL AMOUNT IN Y DIRECTION display	Travel amount in Y direction which is registered to the pattern button No. being sewn is displayed.
V	PATTERN REGISTER button	Pattern button which has been stored in R folder No. is displayed. → Refer to “14. PERFORMING NEW REGISTER OF PATTERN BUTTON” p.35 .

16. PERFORMING PATTERN BUTTON No. SELECTION

16-1 Selection from the data input screen

① Display the data input screen.

In case of the data input screen (blue), it is possible to select the pattern button No. In case of the sewing screen (green), press READY key  to display the data input screen.

② Call the pattern button No. selection screen.

When PATTERN BUTTON No. SELECTION button  **A** is pressed, the pattern button No. selection screen is displayed. Pattern button No. which is selected at present and the contents are displayed on the upper part of the screen, and the list of the pattern button No. buttons which have been registered is displayed on the lower part of the screen.

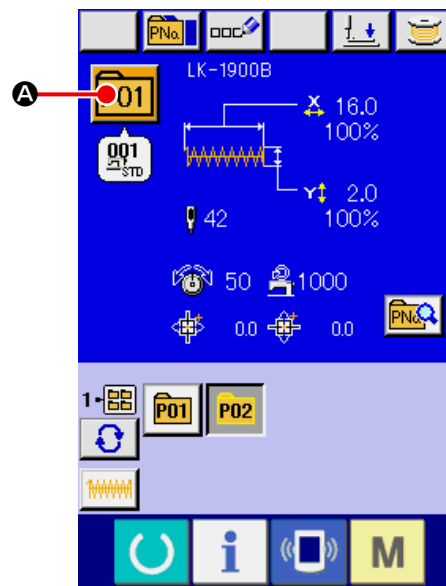

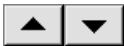
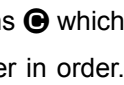
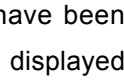

③ Select the pattern button No.

When UP or DOWN SCROLL button  **B** is pressed, pattern button No. buttons  which have been registered are changed over in order. The contents of sewing data which have been inputted in the pattern button No. are displayed in the button. Here, press the pattern button No. button  **C** you desire to select.

④ Determine the pattern button No.

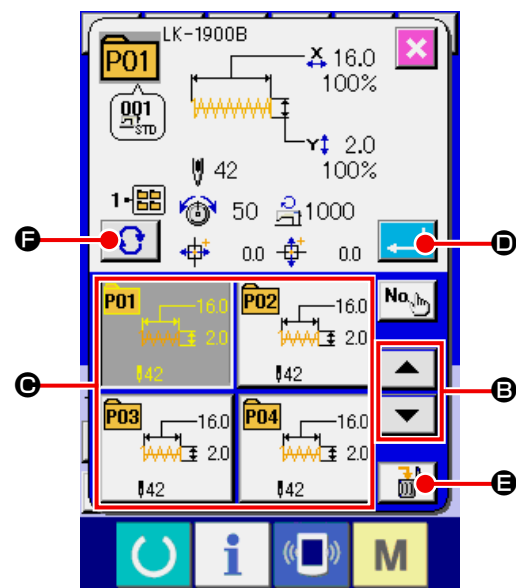
When ENTER button  **D** is pressed, the pattern button No. selection screen is closed and the selection is finished.



- * When you desire to delete the pattern button which has been registered, press DELETE  **E** button. However, the pattern buttons which are registered to the combination sewing cannot be deleted.
- * For the pattern No. to be displayed, press FOLDER SELECTION  **F** button and pattern button Nos. which have been stored in the specified folder are displayed in the list. When the folder No. is not displayed, all pattern Nos. which have been registered are displayed.

16-2 Selection by means of the shortcut button

① Display the data input screen or the sewing screen.

When the pattern is registered to the folder, pattern buttons **A** are surely displayed on the lower side of the screen of the data input screen or sewing screen.

② Select the pattern No.

Pattern button is displayed with every folder which is specified when the pattern is newly created.

When FOLDER SELECTION button  **B** is pressed, the pattern button to be displayed is changed.

Display and press the button of the pattern button No. you desire to sew. When it is pressed, the pattern button No. is selected.

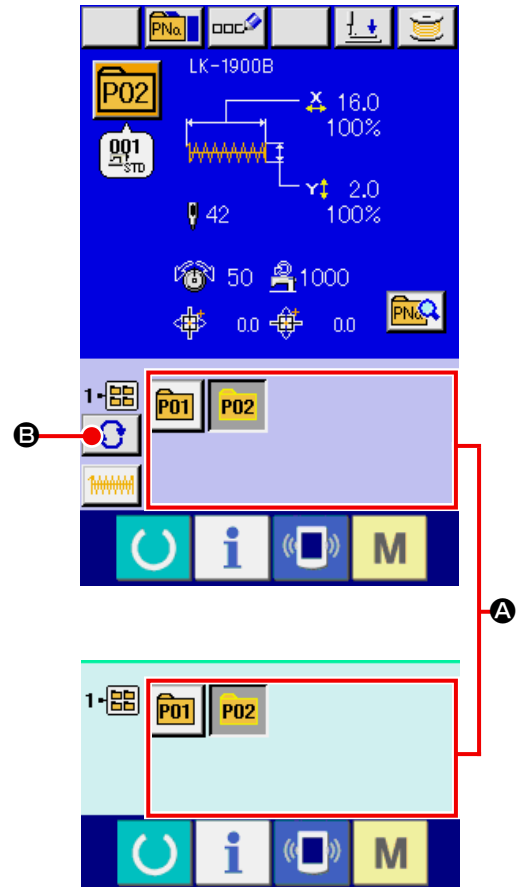

1. Make sure without fail of the contour of the sewing pattern after selection of the sewing pattern. If the sewing pattern extends outside the work clamp feet, the needle will interfere with the work clamp feet during sewing, causing dangerous troubles including needle breakage.
2. When the sewing screen is displayed and pressing P01 to P50 keys, the presser comes down. Be careful not to allow the fingers to be caught in it.

17. CHANGING CONTENTS OF PATTERN BUTTON

- ① **Display the data input screen at the time of pattern button selection.**

Only in case of the data input screen (blue) at the time of pattern selection, it is possible to change the contents of pattern.

In case of the sewing screen (green), press READY key  to display the data input screen at the time of the pattern button selection.

- ② **Display the pattern button data change screen.**

When PATTERN BUTTON DATA CHANGE button  **A** is pressed, the pattern button data change screen is displayed.

- ③ **Display the input screen of the item data you desire to change.**

Data which are possible to be changed are 12 items below.

	Item	Input range	Initial value
B	Scale rate in X direction	20 to 200 (%)	100
C	Scale rate in Y direction	20 to 200 (%)	100
D	Thread tension	0 to 200	50
E	Max. speed limitation	1900 : 400 to 3200 (sti/min)	3200
		1901 and 1902 : 400 to 3000 (sti/min)	3000
		1903 and 1900 double-capacity hook : 400 to 2700 (sti/min)	2700
F	Travel amount in X direction	-20.0 to 20.0 (mm)	0.0
G	Travel amount in Y direction	-20.0 to 10.0 (mm)	0.0
H	Sewing shape	-	-
I	Folder No.	1 to 5	-
J	Thread clamp	With/without	With
K	2-step stroke height	50 to 90	70
L	Last stitch position X-travel amount	- 2.0 to 2.0	0.0
M	Last stitch position Y-travel amount	- 2.0 to 2.0	0.0

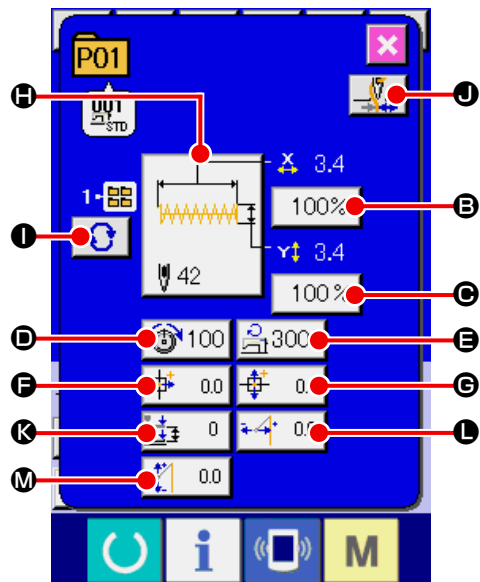
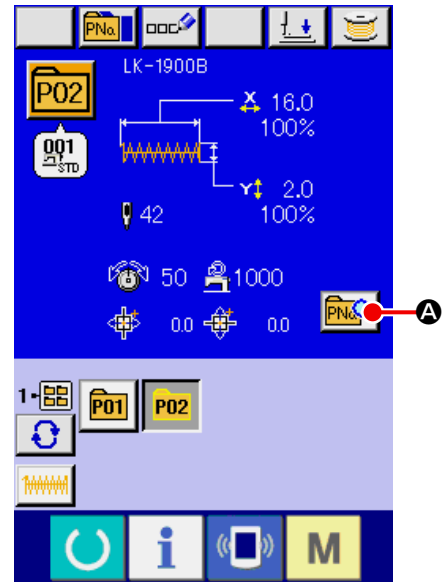

When each button from **B** to **M** is pressed, the item data input screen is displayed. When the buttons of **I** and **J** are pressed, Folder Nos. and With/without thread clamp are changed over.

- * **B** Scale rate in X direction and **C** Scale rate in Y direction can be changed to the actual size value input by selection of memory switch **U064**.
- * Range of max input of max. limitation speed **E** and the initial value are determined with memory switch **U001**.
- * When the prohibition of thread clamp is set with memory switch **U035**, the button of thread clamp **J** is not displayed.
- * For 2-step work clamp height stroke **K**, display/hide can be selected with memory switch **U069**. (Initial setting: Hide)

When "Hide" is selected, the stroke is not displayed on the data edit screen.

- * For the last stitch position X-travel amount **L** and the last stitch position Y-travel amount **M**, display/hide can be selected with memory switch **U070**. (Initial setting: Hide)

When "Hide" is selected, the stroke is not displayed on the data edit screen.

④ **Determine the change of item data.**

For example, input X scale rate. Press **B** to display the item data input screen.

Input the value you desire with the ten keys or + or - key **K**.

When ENTER button  **L** is pressed, the data is determined.

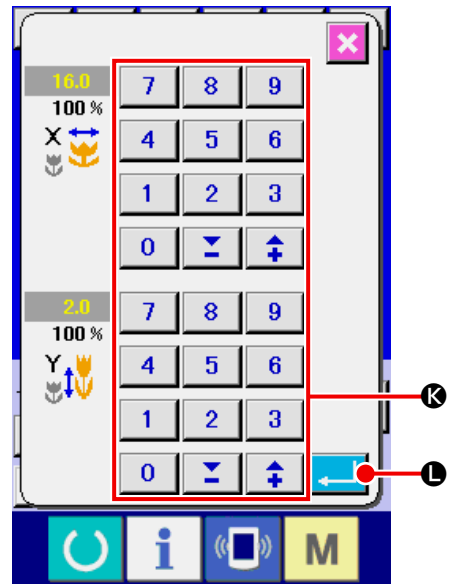

⑤ **Close the pattern button data change screen.**

When the change is over, press CLOSE button  **M**. The pattern button data change screen is closed and the screen returns to the data input screen.

* It can be performed to change the other item data by the same operation.

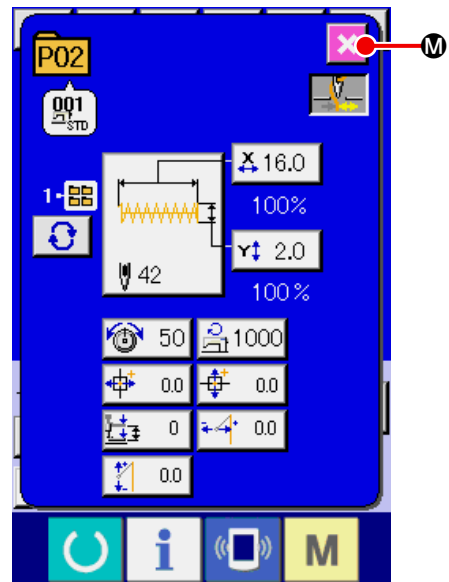



18. NAMING PATTERN

Pattern name can be inputted to the pattern button, users' pattern, media pattern and combination sewing. It is possible for the pattern button and combination sewing as many as 14 letters, and for the users' pattern, media pattern as many as 255 letters.

① Call the character input screen.

When CHARACTER INPUT button  **A** is pressed, the character input screen is displayed.

② Input the character.

Press CHARACTER button **B** you desire to input and the input of character can be performed. The cursor can be moved with CURSOR LEFT TRAVEL button  **C** and CURSOR RIGHT TRAVEL button  **D**. When you desire to delete the inputted character, adjust the cursor to the position of the character you desire to delete and press DELETE button  **E**.

③ Finish the input of character.

When ENTER button  **F** is pressed, the input of character is finished. After the finish, the inputted character is displayed on the upper part of the data input screen (blue).

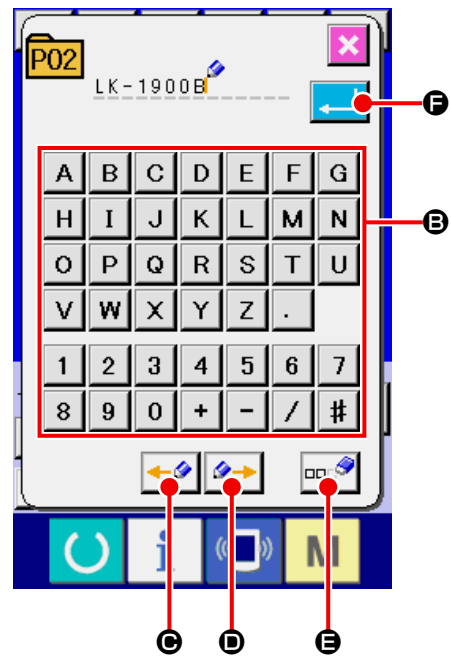
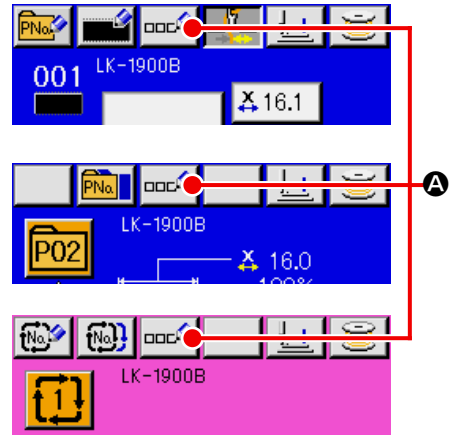

19. COPYING PATTERN BUTTON

The sewing data of the pattern button No. which has already been registered can be copied to the pattern button No. which is not registered.

Overwriting copy of the pattern button is prohibited.

When you desire to overwrite, perform the overwriting after erasing the pattern button once.

→ Refer to “16. PERFORMING PATTERN BUTTON No. SELECTION” p.42 .

① Display the data input screen.

Only in case of the data input screen (blue) at the time of pattern button selection, it is possible to copy. In case of the sewing screen (green), press READY key  to display the data input screen (blue).

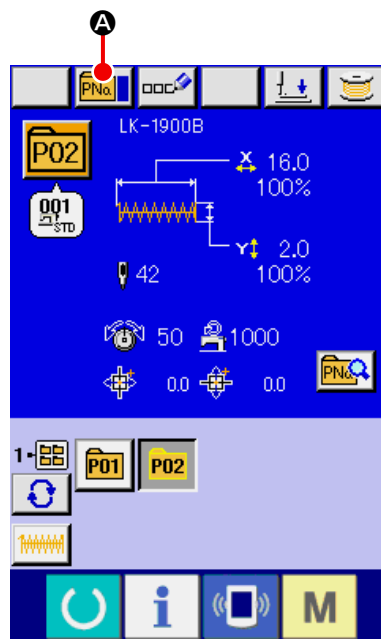

② Call the pattern copy screen.

When PATTERN BUTTON COPY button  **A** is pressed, the pattern button copy (copy source selection) screen is displayed.

③ Select the pattern No. of copy source.

Select the pattern button No. of copy source from the pattern button list button **B** .

Next, press COPY DESTINATION INPUT button  **C** and the copy destination input screen is displayed.

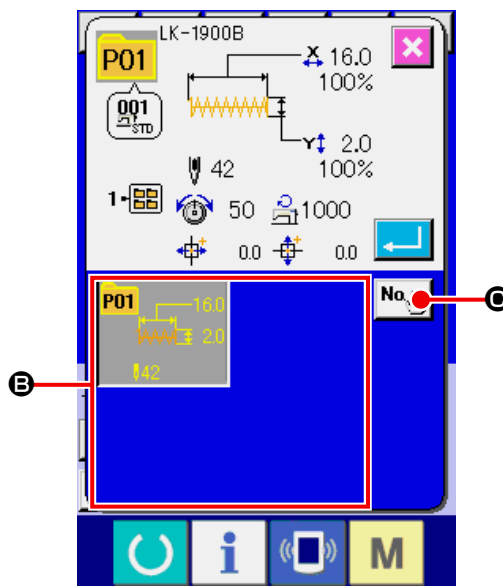

④ **Input the pattern No. of copy destination.**

Input the pattern button No. of copy destination with ten keys **D** . Pattern button No. which is not used yet can be retrieved with - and + buttons (**E** and **F**).

In addition, the folder to be stored can be selected with FOLDER SELECTION button  **G** .

⑤ **Start copying.**

When ENTER button  **H** is pressed, copying starts. The copied pattern button No. in the selection state returns to the pattern button copy (copy source selection) screen after approximately two seconds.

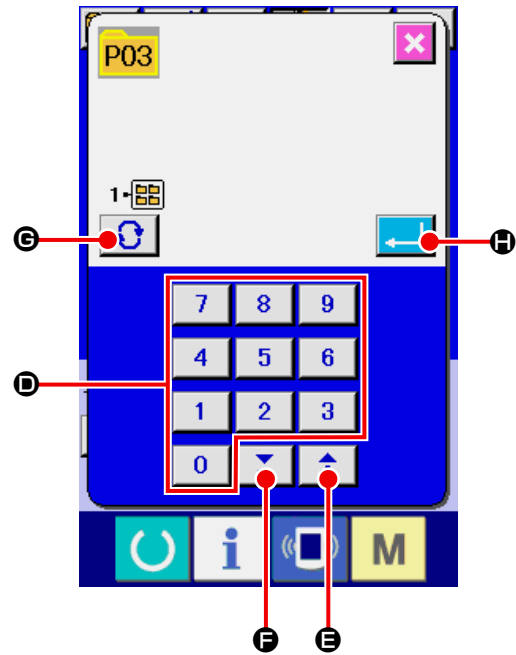

* Combination data can be copied in the same way.

20. CHANGING SEWING MODE

① Select the sewing mode.

When **M** key is pressed in the state that the pattern has been registered, SEWING MODE

SELECTION button  **A** is displayed on the

screen. When this button is pressed, the sewing mode changes over alternately to the individual and the combination sewing.

- * The image of the button of sewing mode selection button changes according to the sewing mode which is selected at present.

When individual sewing is selected : 

When combination sewing is selected : 

- * When even one of the pattern buttons has not been registered, it is not possible to change over from the individual sewing to the combination sewing.

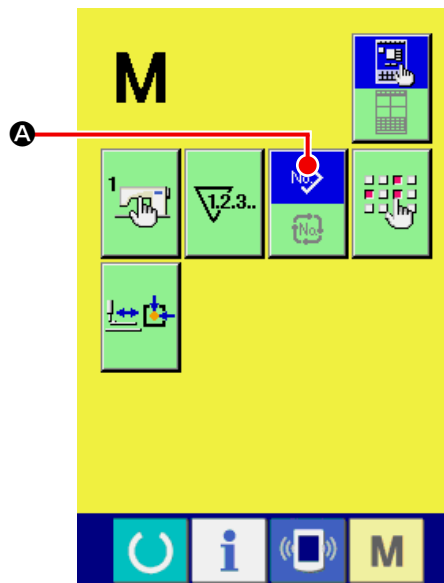

21. LCD DISPLAY SECTION AT THE TIME OF COMBINATION SEWING

The sewing machine is capable of sewing in order by combining the plural pattern data.

As many as 99 patterns can be inputted. Use this function when sewing plural different shapes on the sewing product. In addition, it is possible to register as many as 99 of the combination sewing data. Use this function for new creation and copying in case of need.

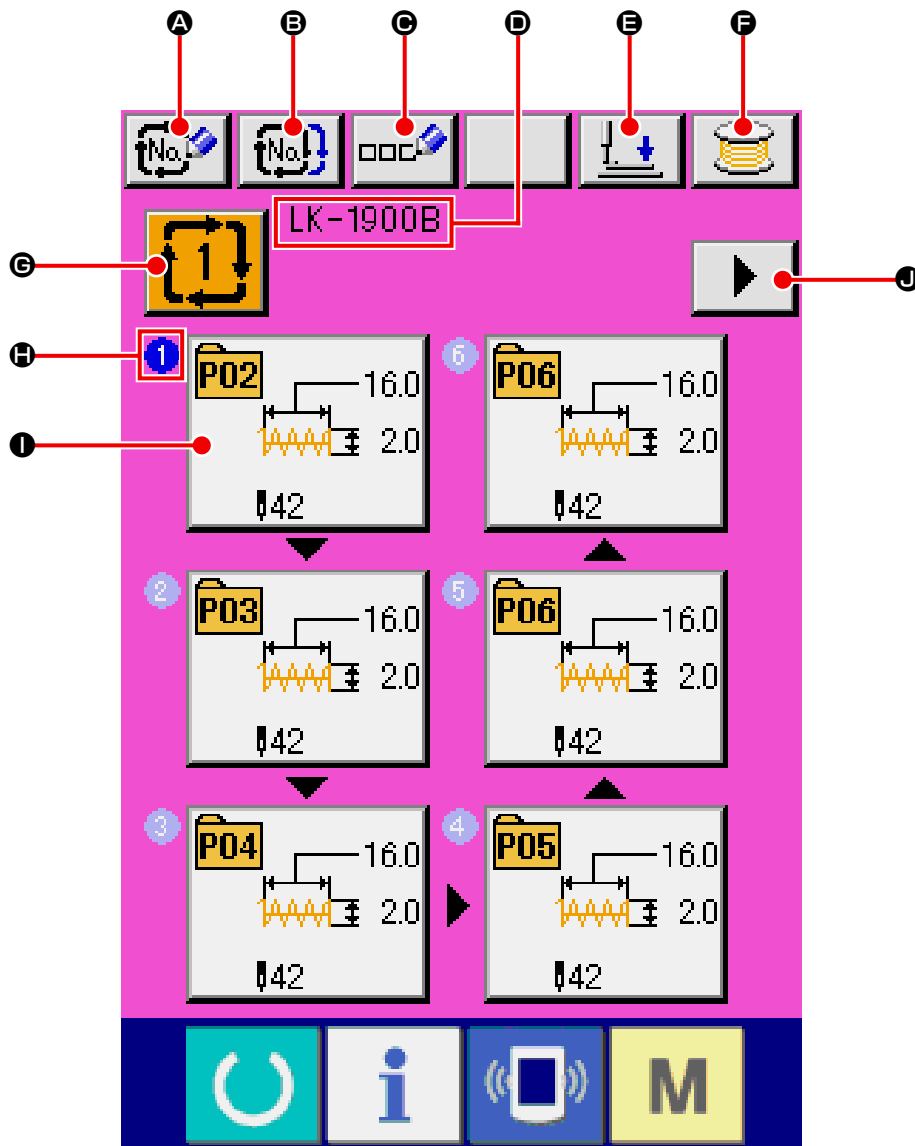

→ Refer to “14. PERFORMING NEW REGISTER OF PATTERN BUTTON” p.35 . and “19. COPYING PATTERN BUTTON” p.47 .

21-1 Pattern input screen



	Button and display	Description
Ⓐ	COMBINATION DATA NEW REGISTER button	Combination data No. new register screen is displayed. → Refer to “14. PERFORMING NEW REGISTER OF PATTERN BUTTON” p.35 .
Ⓑ	COMBINATION DATA COPY button	Combination pattern No. copy screen is displayed. → Refer to “19. COPYING PATTERN BUTTON” p.47 .
Ⓒ	COMBINATION DATA NAME INPUT button	Combination data name input screen is displayed. → Refer to “18. NAMING PATTERN” p.46 .
Ⓓ	COMBINATION DATA NAME display	Name which is inputted in the combination data being selected is displayed.
Ⓔ	PRESSER DOWN button	Presser can be lowered and the presser down screen is displayed. To raise the presser, press the presser up button displayed in the presser down screen.
Ⓕ	BOBBIN WINDING	Bobbin thread can be wound. → Refer to “11. WINDING BOBBIN THREAD” p.29 .
Ⓖ	COMBINATION DATA No. SELECTION button	Combination data No. being selected is displayed in the button. When the button is pressed, the combination data No. selection screen is displayed.
Ⓗ	SEWING ORDER display	Sewing order of the inputted pattern data is displayed. When the screen is changed over to the sewing screen, the pattern which is sewn first is displayed in blue color.
Ⓘ	PATTERN SELECTION button	Pattern No. , shape, number of stitches, etc. which are registered in Ⓗ Sewing order are displayed on the button. When the button is pressed, the pattern selection screen is displayed.
Ⓢ	NEXT PAGE DISPLAY button	When the patterns which are registered to the combination data become more than 6 pcs. , this button is displayed. It is possible to register the patterns from the 7th to the next page.

* As many as the number of inputted patterns is displayed in Ⓗ and Ⓘ , display and button.

	Button and display	Description
A	COMBINATION DATA NAME display	Name which is inputted in the combination data being selected is displayed.
B	THREAD CLAMP button	Effective/ineffective of thread clamp is selected.  : Thread clamp ineffective  : Thread clamp effective * When the prohibition of the thread clamp is set with memory switch U035 , the thread clamp button is not displayed.
C	PRESSER DOWN button	Presser can be lowered and the presser down screen is displayed. To raise the presser, press the presser up button displayed in the presser down screen.
D	RETURN TO ORIGIN button	Presser can be returned to the start of sewing and is raised.
E	COMBINATION DATA No. display	Combination data No. being selected is displayed.
F	PATTERN BUTTON No. display	Pattern button No. being sewn is displayed.
G	SEWING SHAPE display	Sewing shape which is registered to pattern button No. being sewn is displayed.
H	SEWING ORDER RETURN button	Pattern to be sewn can be returned by one.
I	SEWING ORDER ADVANCE button	Pattern to be sewn can be advanced by one.
J	SEWING ORDER ADVANCE button	Pattern to be sewn can be advanced by one
K	TOTAL NUMBER OF REGIS- TERS display	Total number of patterns which is registered to combination No. being sewn is displayed.
L	TOTAL NUMBER OF STITCHES display	Total number of stitches of sewing shape being sewn is displayed.
M	THREAD TENSION display	Thread tension value which is registered to pattern button No. being sewn is displayed.
N	TRAVEL AMOUNT IN X DIREC- TION display	Travel amount in X direction which is registered to the pattern button No. being sewn is displayed.
O	COUNTER VALUE CHANGE button	Existing counter value is displayed on this button. When the button is pressed, the counter value change screen is displayed. → Refer to “12. USING COUNTER” p.30 .
P	COUNTER CHANGEOVER but- ton	Display of sewing counter/No. of pcs. counter can be changed over. → Refer to “12. USING COUNTER” p.30 .

	Button and display	Description
Ⓒ	X ACTUAL SIZE VALUE display	X actual size value of the sewing shape which is registered to pattern button No. being sewn is displayed.
Ⓓ	X SCALE RATE display	Scale rate in X direction of the sewing shape which is registered to pattern button No. being sewn is displayed.
Ⓔ	SPEED variable resistor	Number of revolutions of the sewing machine can be changed.
Ⓗ	Y ACTUAL SIZE VALUE display	Y actual size value of the sewing shape which is registered to pattern button No. being sewn is displayed.
Ⓘ	Y SCALE RATE display	Y scale rate of the sewing shape which is registered to pattern button No. being sewn is displayed.
Ⓥ	MAX. SPEED LIMITATION display	Maximum speed limitation which is registered to pattern button No. being sewn is displayed.
Ⓦ	TRAVEL AMOUNT IN Y DIRECTION display	Travel amount in Y direction which is registered to the pattern button No. being sewn is displayed.
Ⓧ	STEP SEWING button	The step sewing screen is displayed. Checking the pattern shape can be performed. → Refer to “7. CHECKING PATTERN SHAPE” p.19 .

22. PERFORMING COMBINATION SEWING

First, change the sewing mode to the combination sewing before performing setting.

→ Refer to "20. CHANGING SEWING MODE" p.49 .

22-1 How to create combination data

① Display the data input screen.

Only in case of the data input screen (pink), it is possible to input the combination data. In case of the sewing screen (green), press READY switch  to display the data input screen (pink).

Pattern No. has not been registered in the initial state, and the first pattern selection button is displayed in the blank state.

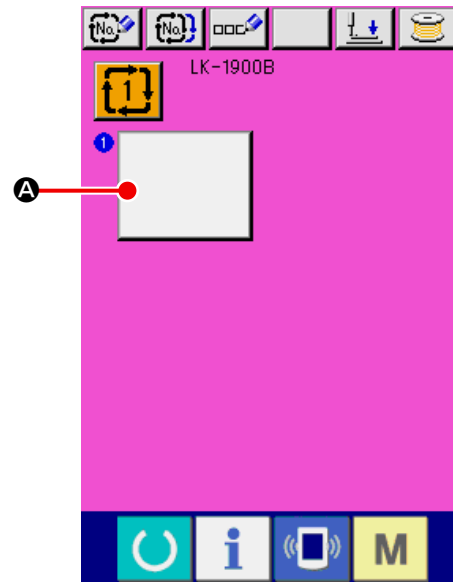

② Display the pattern No. selection screen.

When PATTERN SELECTION button  **A** is pressed, the pattern No. selection screen is displayed.

③ Select the pattern No.

When UP/DOWN SCROLL button  **B** is pressed, pattern No. buttons **C** which have been registered are changed over in order.

The contents of pattern data are displayed in the buttons. Here, press the pattern No. buttons you desire to select.

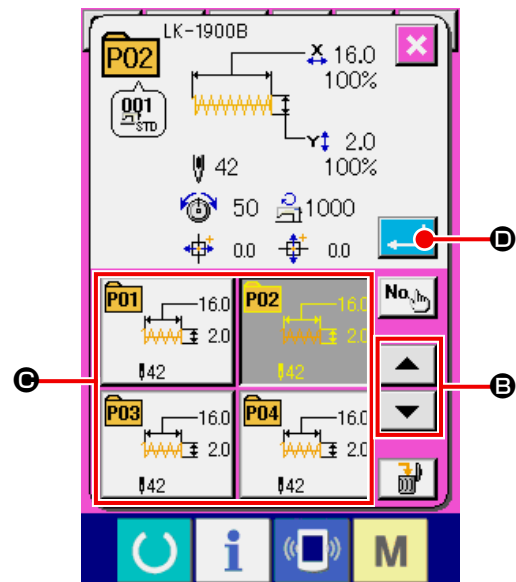

④ Determine the pattern No.

When ENTER button  **D** is pressed, the pattern No. selection screen is closed and the selection is finished.

- ⑤ Repeat steps ② through ④ as many as the number of pattern Nos. you desire to register. When the first register is determined, the second pattern selection button  is displayed. Repeat steps ② through ④ as many as the number of pattern Nos. you desire to register.

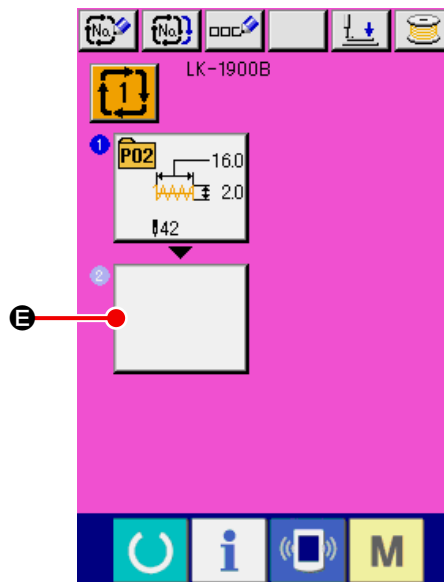

22-2 Selection of combination data

- ① Display the data input screen.

Only in case of the data input screen (pink), it is possible to select the combination data No. In case of the sewing screen (green), press READY key  to display the data input screen (pink).

- ② Call the combination data No. screen.

When COMBINATION DATA No. button  is pressed, the combination data No. selection screen is displayed. Combination data No. which is selected at present and the contents are displayed in the upper part of the screen, and other combination data No. buttons which have been registered are displayed in the lower part of the screen.

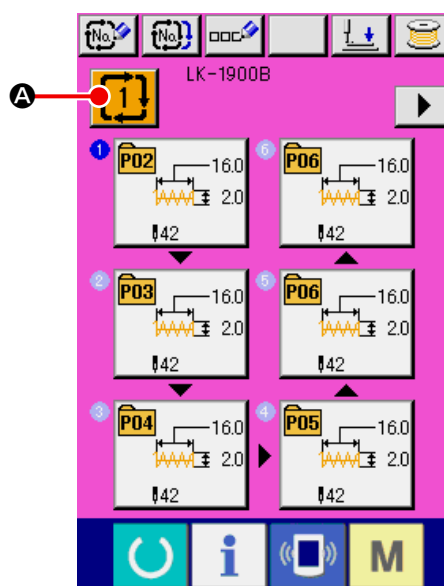

③ **Select the combination data No.**

When UP/DOWN SCROLL button 

B is pressed, the combination data No. buttons **C** which have been registered are changed over in order. The contents of combination data are displayed in the buttons. Here, press the combination data buttons **C** you desire to select. When STEP CONFIRMATION button  **E** is pressed, the sewing shapes of patterns which have been registered to the combination data are changed over in order and displayed.

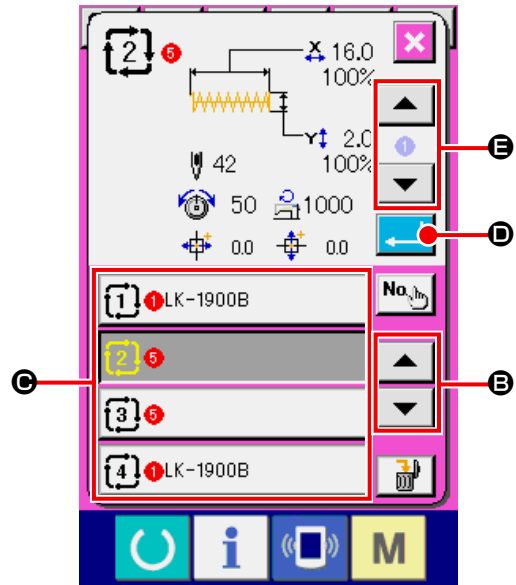

④ **Determine the combination data No.**



When ENTER button  **D** is pressed, the combination data No. selection screen is closed and the selection is finished.

22-3 How to delete combination data

① **Select the combination data No.**

Perform the steps ① to ③ of "22-2 Selection of combination data" p.56 , and display the combination data to be deleted.

② **Delete the combination data.**

When DATA DELETE button  **A** is pressed, the combination data delete confirmation screen is displayed. Here press ENTER button  **B** and the selected combination data is deleted.

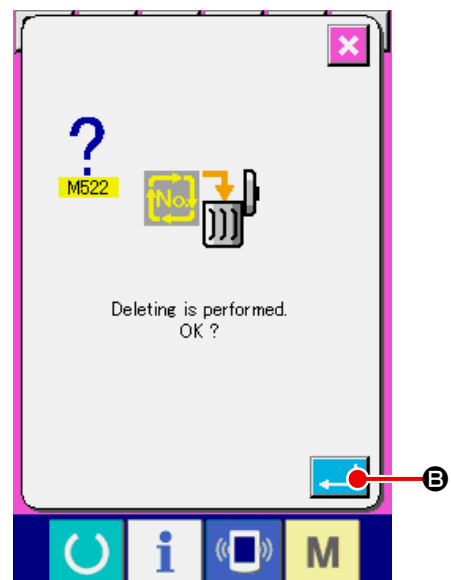
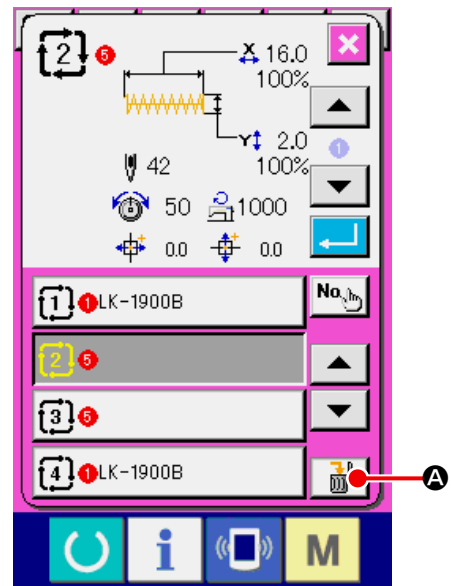

22-4 How to delete combination data step

① Select the combination data No.

Perform the steps ① through ③ of "22-2 Selection of combination data" p.56 and make the state that the combination data including the step you desire to delete is selected.

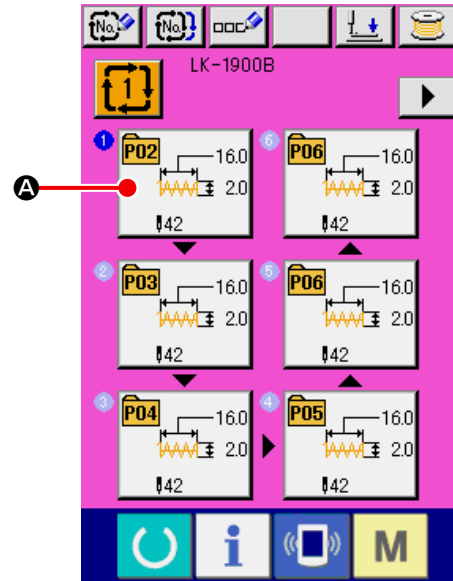

② Display the pattern No. selection screen.

When PATTERN SELECTION button  A of the step you desire to delete is pressed, the pattern No. selection screen is displayed.

③ Delete the step of the selected combination data.

When DATA STEP DELETE button  B is pressed, the combination data step delete confirmation screen is displayed.

When ENTER button  C is pressed, the step is deleted from the selected combination data, and the screen returns to the data input screen (pink).

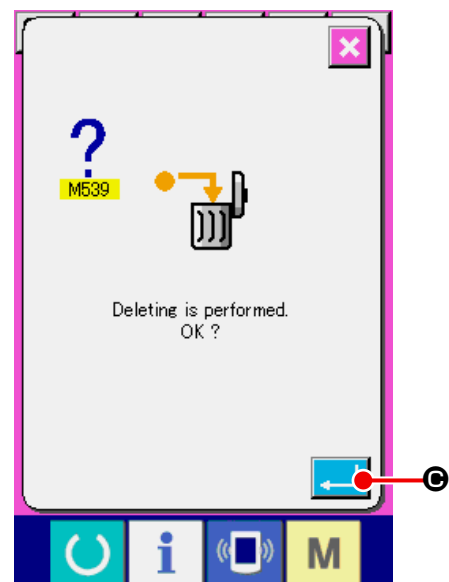
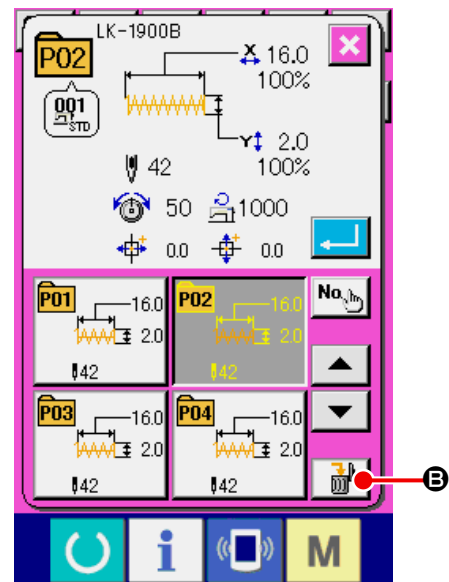

23. CHANGING MEMORY SWITCH DATA

23-1 How to change memory switch data

23-1-1 Level 1

① Display the memory switch data list screen.

When **M** key is pressed, memory switch button 1 **A** is displayed. When this button is pressed, the memory switch data list screen of level 1 is displayed.

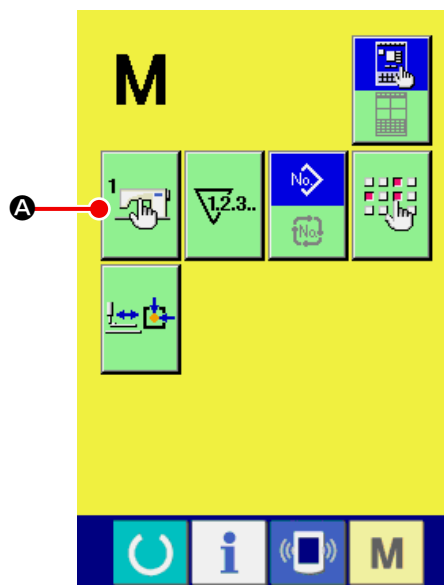

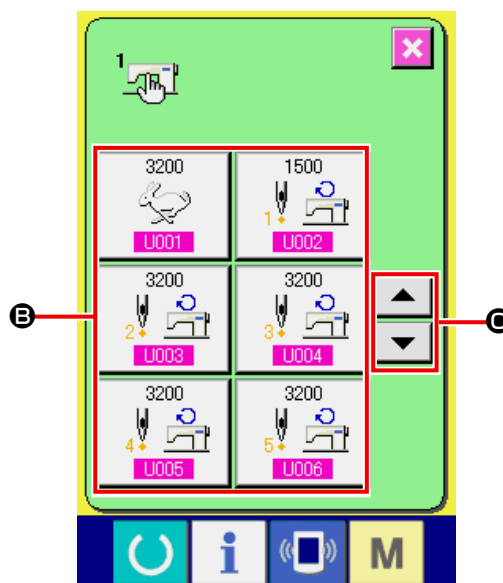

② Select the memory switch button you desire to change.

Press UP/DOWN SCROOL button  **C** and select the data item **B** you desire to change.



③ **Change the memory switch data.**

There are data items to change numerals and those to select pictographs in the memory switch data.

No. in pink color such as **U001** is put on the data items to change numerals and the set value can be changed with +/- keys    displayed in the change screen.

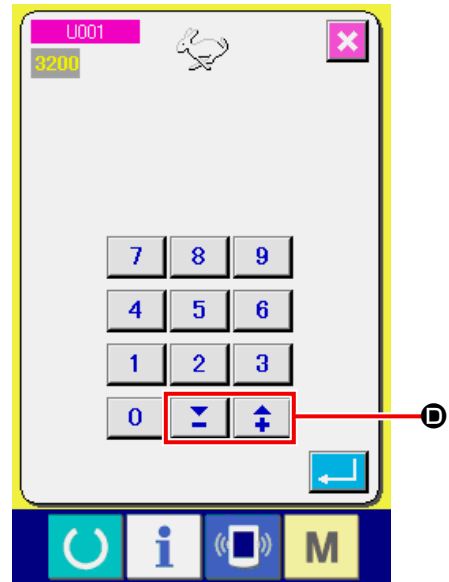

No. in blue color such as **U019** is put on the data items to select pictographs and the pictographs displayed in the change screen can be selected.

→ For the details of memory switch data, refer to

"23-2 Memory switch data list" p.62 .

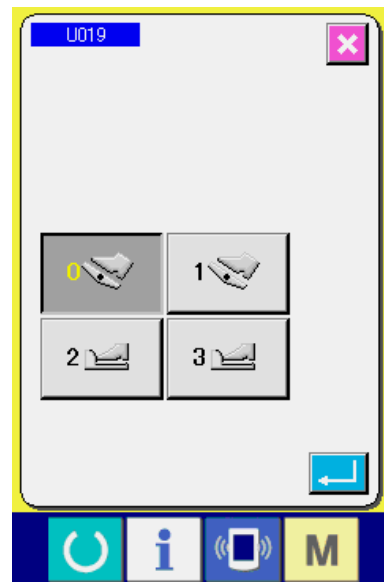

23-1-2 Level 2

① Display the memory switch data list screen.

When **M** key is pressed as long as 6 seconds, the memory switch button 2 **A** is displayed.

When this button is pressed, the memory switch data list screen of level 2 is displayed.

② Change the memory switch data.



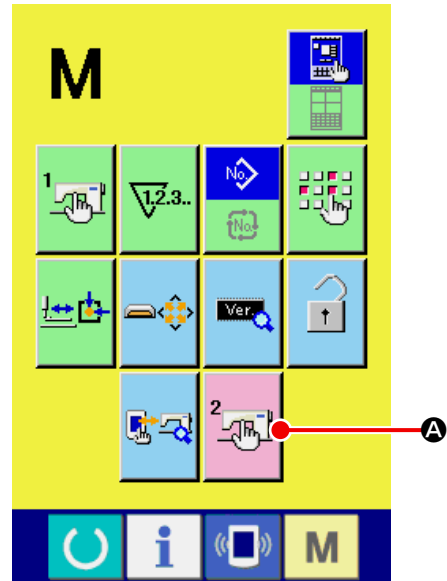









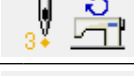
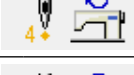

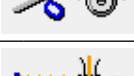



Perform the steps ② and ③ of the level 1 similarly and the change of memory switch data can be performed.







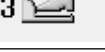







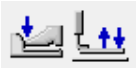

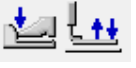
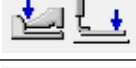
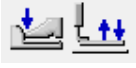
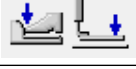
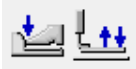

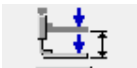











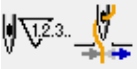







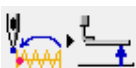











23-2 Memory switch data list





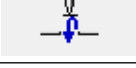

















Memory switch data are the motion data that the sewing machine has in common and the data that operate on all sewing patterns in common. However, the max. speed limitation of LK-1903B and LK-1900BWS (double capacity hook type) is 2,700 sti/min.







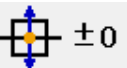
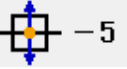
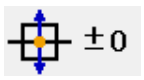
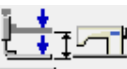

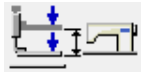





23-2-1 Level 1



No.	Item	Setting range	Edit unit	Initial display
U001	Maximum sewing speed 	400 to 3200	100sti/min	3200sti/min
U002	Sewing speed of 1st stitch In case of with thread clamp 	400 to 1500	100sti/min	1500sti/min
U003	Sewing speed of 2nd stitch In case of with thread clamp 	400 to 3200	100sti/min	3200sti/min
U004	Sewing speed of 3rd stitch In case of with thread clamp 	400 to 3200	100sti/min	3200sti/min
U005	Sewing speed of 4th stitch In case of with thread clamp 	400 to 3200	100sti/min	3200sti/min
U006	Sewing speed of 5th stitch In case of with thread clamp 	400 to 3200	100sti/min	3200sti/min
U007	Thread tension of 1st stitch In case of with thread clamp 	0 to 200	1	200
U008	Thread tension setting at the time of thread trimming 	0 to 200	1	0
U009	Thread tension changeover timing at the time of thread trimming 	-6 to 4	1	0
U010	Sewing speed of 1st stitch In case of without thread clamp 	400 to 1500	100sti/min	400sti/min
U011	Sewing speed of 2nd stitch In case of without thread clamp 	400 to 3200	100sti/min	900sti/min
U012	Sewing speed of 3rd stitch In case of without thread clamp 	400 to 3200	100sti/min	3200sti/min
U013	Sewing speed of 4th stitch In case of without thread clamp 	400 to 3200	100sti/min	3200sti/min
U014	Sewing speed of 5th stitch In case of without thread clamp 	400 to 3200	100sti/min	3200sti/min
U015	Thread tension of 1st stitch In case of without thread clamp 	0 to 200	1	0
U016	Thread tension changeover timing at the start of sewing In case of without thread clamp 	-5 to 2	1	-5
U019	Presser pedal selection <div style="display: flex; flex-direction: column; gap: 5px;"> <div> : Standard pedal</div> <div> : Standard pedal (2-step stroke)</div> <div> : Optional pedal</div> <div> : Optional pedal (2-step stroke)</div> </div>	—	—	<div style="display: flex; flex-direction: column; align-items: center; gap: 10px;"> <div> 0</div> <div style="text-align: center;">In case of LK-1903B/BR35, the initial value is</div> <div> 2</div> </div>

No.	Item	Setting range	Edit unit	Initial display
U020	Start pedal selection  : Standard pedal  : Optional pedal	—	—	 In case of LK-1903B/BR35, the initial value is 
U024	Optional pedal 1-motion  : OFF by toe down  : OFF by releasing	—	—	 In case of LK-1903B/BR35, the initial value is 
U025	Optional pedal 2-motion  : OFF by toe down  : OFF by releasing	—	—	 
U026	Height of presser at the time of 2-step scrolling 	50 to 90	1	70
U030	Scale rate reference point of pattern selection  : Origin  : Sewing start point	—	—	
U031	Sewing machine motion can be stopped with panel button (temporary stop button).  : Ineffective  : Panel temporary stop button  : External switch	—	—	
U032	Buzzer sound can be prohibited.  : Without buzzer sound  : Panel operating sound  : Panel operating sound + error sound	—	—	
U033	Number of stitches of thread clamp release is set. 	1 to 20	1	2
U034	Clamping timing of thread clamp can be delayed. 	-10 to 4	1	0











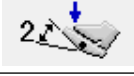

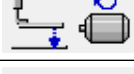
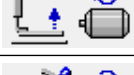
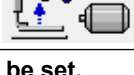



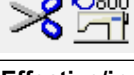

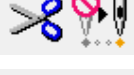
No.	Item	Setting range	Edit unit	Initial display
U035	Thread clamp control can be prohibited.  : Normal  : Prohibited	—	—	 In case of LK-1903, the initial value is 
U036	Feed motion timing is selected. Set the timing in "-" direction when stitch is not well-tightened. 	-8 to 16	1	12
U037	State of the presser after end of sewing is selected.  : Presser goes up after moving at start of sewing  : Presser goes up immediately after end of sewing.  : Presser goes up by pedal operation after moving at start of sewing.	—	—	  
U039	Origin retrieval can be performed every time after end of sewing (other than cycle sewing).  : Without origin retrieval  : With origin retrieval	—	—	
U040	Origin retrieval in cycle sewing can be set.  : Without origin retrieval  : Every time 1 pattern is finished.  : Every time 1 cycle is finished.	—	—	
U041	State of presser when sewing machine stops by temporary stop command can be selected.  : Presser rise.  : Presser rise with presser switch.  : Presser rise is prohibited.	—	—	
U042	Needle stop position is set.  : UP position  : Upper dead point	—	—	
U046	Thread trimming can be prohibited.  : Normal  : Thread trimming prohibited	—	—	

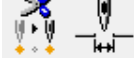





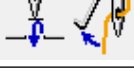









No.	Item	Setting range	Edit unit	Initial display
U048	<p>Route of return to origin by return to origin button can be selected.</p>  : Linear return  : Reverse return of pattern	—	—	
U049	<p>Bobbin winding speed can be set.</p> 	800 to 2000	100sti/min	1600sti/min
U050	<p>Motion timing of cloth drawing can be selected. This item is not displayed for the machines other than LK-1901.</p>  : Output prohibited  : Motion when presser comes down.  : Motion at the time of start	—	—	
U051	<p>Motion method of wiper can be selected.</p>  : Motion together with presser rise  : Motion while presser is held down (Wiper does not return at the last thread trimming.)  : Motion while presser is held down (Wiper returns at the last thread trimming.)  : Magnet type wiper	—	—	 In case of LK-1903B/BR35, 
U055	<p>Tie stitching at the start of sewing of button can be prohibited. This item is not displayed for the machines other than LK-1903B.</p>  : Tie stitching effective  : Tie stitching ineffective	—	—	
U064	<p>Unit of sewing shape size change can be selected.</p>  % : % input  mm : Actual size input	—	—	
U065	<p>Origin position is located on the front side by 5 mm. This item is necessary when using the presser and pattern for LK-1904.</p>  ± 0 : Standard  - 5 : Front side	—	—	
U069	<p>Used to select either common or individual for the 2-step work clamp height stroke</p>  : Common  : Individual (can be set for each direct pattern)	—	—	



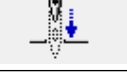





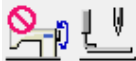

No.	Item	Setting range	Edit unit	Initial display
U070	<p>Used to set display/hide of the last stitch position travel</p>  : Non-display  : Display	—	—	
U074	<p>Used to set the fan operation</p>  : Energy saving mode  : Constant operation	—	—	
U075	<p>With/without air pressure detection</p>  : Without  : With <p>* This memory switch is displayed only for the LK-1900BB, LK-1903BB.</p>	—	—	
U076	<p>Correction of thread waste retaining position</p> <p>With this switch, the timing to start traveling from the thread clamping position to the thread releasing/thread waste retaining position can be changed.</p>  <p>* This memory switch is displayed only for the LK-1900BB, LK-1903BB.</p>	<p>–10 to 10 (In the range of –344°- 64° in increments of 4°)</p>	0	
U086	<p>Thread waste suction actuation time</p> <p>Length of time to be elapsed from the turning-ON of the thread waste suction nozzle/thread waste suction to the turning-OFF of it</p>  <p>* This memory switch is displayed only for the LK-1900BB, LK-1903BB.</p>	<p>LK-1900BB : 110 to 3000ms LK-1903BB : 140 to 3000ms</p>	10 ms	<p>LK-1900BB : 110 LK-1903BB : 140</p>
U087	<p>Thread waste suction nozzle actuation time</p> <p>Length of time to be elapsed from the turning-ON of the thread waste suction nozzle to the turning-OFF of it</p>  <p>* This memory switch is displayed only for the LK-1900BB, LK-1903BB.</p>	110 to 1000	10 ms	110
U088	<p>Number of stitches for releasing thread-waste</p> <p>Time lapse (i.e., the number of stitches to be sewn) from trimming of thread at the beginning of sewing to releasing of thread</p>  <p>* This memory switch is displayed only for the LK-1900BB, LK-1903BB.</p>	0 to 999 stitches	1 stitch	<p>LK-1900BB : 5 LK-1903BB : 0</p>
U089	<p>Bird's nest suction time</p> <p>Time during which the thread tangling in at the beginning of sewing (so-called bird's nest) is being sucked</p>  <p>* This memory switch is displayed only for the LK-1900BB, LK-1903BB.</p>	100 to 1000 ms	10 ms	100

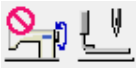







No.	Item	Setting range	Edit unit	Initial display																																
U090	<p>Rest time to the start of suction of bird's nest</p> <p>Time lapse from trimming of shorter thread remaining on the material to suction of thread tangling in at the beginning of sewing</p> <p>* This memory switch is displayed only for the LK-1903BB.</p> 	80 to 500 ms	10 ms	80																																
U239	<p>Language selection</p> <p>With this switch, the language to be displayed on the panel is selected.</p> <table border="1" data-bbox="272 472 932 842"> <tr> <td>日本語</td> <td>English</td> <td>中文繁體字</td> <td>中文简体字</td> </tr> <tr> <td>Japanese</td> <td>English</td> <td>Chinese (traditional)</td> <td>Chinese (simplified)</td> </tr> <tr> <td>Español</td> <td>Italiano</td> <td>Français</td> <td>Deutsch</td> </tr> <tr> <td>Spanish</td> <td>Italian</td> <td>French</td> <td>German</td> </tr> <tr> <td>Português</td> <td>Türkçe</td> <td>Tiếng Việt</td> <td>한국어</td> </tr> <tr> <td>Portuguese</td> <td>Turkish</td> <td>Vietnamese</td> <td>Korean</td> </tr> <tr> <td>Indonesia</td> <td>Русский</td> <td></td> <td></td> </tr> <tr> <td>Indonesian</td> <td>Russian</td> <td></td> <td></td> </tr> </table>	日本語	English	中文繁體字	中文简体字	Japanese	English	Chinese (traditional)	Chinese (simplified)	Español	Italiano	Français	Deutsch	Spanish	Italian	French	German	Português	Türkçe	Tiếng Việt	한국어	Portuguese	Turkish	Vietnamese	Korean	Indonesia	Русский			Indonesian	Russian			—	—	Not yet selected
日本語	English	中文繁體字	中文简体字																																	
Japanese	English	Chinese (traditional)	Chinese (simplified)																																	
Español	Italiano	Français	Deutsch																																	
Spanish	Italian	French	German																																	
Português	Türkçe	Tiếng Việt	한국어																																	
Portuguese	Turkish	Vietnamese	Korean																																	
Indonesia	Русский																																			
Indonesian	Russian																																			
U245	<p>Grease-up error clear</p> <p>Clearing of number of stitches of grease-up is performed.</p> <p>→ Refer to “9. PERFORMING RELEASE OF GREASE-UP ERROR” p.25 .</p> 	—	—	—																																

23-2-2 Level 2









No.	Item	Setting range	Edit unit	Initial display
K021	Presser switch position of the standard pedal is set. 	10 to 250	1	90
K022	2-motion stroke switch position of the standard pedal is set. 	10 to 250	1	150
K023	Start switch position of the standard pedal is set. 	10 to 250	1	230
K027	Motor-driven work clamp lowering speed 	100 to 400pps	10pps	400pps
K028	Motor-driven work clamp lifting speed 	100 to 400pps	10pps	1500pps
K029	Thread trimmer drive speed (+ presser rise) 	100 to 400pps	10pps	3000pps
K038	Presser rise motion at sewing end can be set.  : Normal  : Presser rise prohibited	—	—	
K043	Thread trimming speed  : 400sti/min  : 800sti/min	—	—	
K044	Effective/ineffective selection of thread trimming jump feed control  : Ineffective  : Effective	—	—	
K045	Diameter of needle hole guide at the time of thread trimming jump feed control 	1.6 to 4.0mm	0.2mm	1.6mm
K047	Selection of prohibition of thread trimmer device control  : Normal  : Prohibited	—	—	
K052	Magnet wiper ON output time 	10 to 500ms	10ms	50ms
K053	Magnet wiper OFF delay time 	10 to 500ms	10ms	100ms
K054	Wiper output timing selection at the time of UP dead point stop  : UP position  : UP dead point position	—	—	

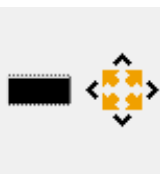



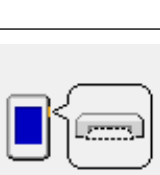

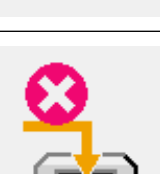

No.	Item	Setting range	Edit unit	Initial display
K056	Range of move limit in + X direction 	-20 to 20mm	1mm	20mm
K057	Range of move limit in -X direction 	-20 to 20mm	1mm	-20mm
K058	Range of move limit in +Y direction 	-20 to 10mm	1mm	10mm
K059	Range of move limit in -Y direction 	-20 to 10mm	1mm	-20mm In case of LK-1901/LK-1903, the initial display is -10mm.
K060	X/Y jump feed speed is set 	100 to 400pps	10pps	2000pps
K061	X/Y feed forward/backward speed is set. 	100 to 400pps	10pps	500pps
K062	Selection of effective/ineffective of automatic preparation motion at the time of turning on the power  : Ineffective  : Effective	—	—	
K063	Selection of effective/ineffective of needle bar stop holding mode  : Ineffective  : Effective	—	—	
K066	Number of pulses of wiper motion that interlocks the presser 	30 to 60	1	45
K068	Thread tension output time at the time of thread tension setting can be set. 	0 to 20sec (0 : Without thread tension output)	1sec	0sec
K091	Used to enable/disable the feed forward travel function, when checking the shape, while the needle is in its lower position  : Ineffective  : Effective	—	—	





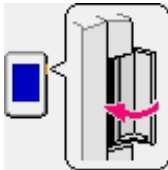

No.	Item	Setting range	Edit unit	Initial display
K092	<p>Used to enable/disable the feed forward travel function, when checking the shape, by means of the pulley</p>  : Ineffective  : Effective	—	—	
K093	<p>Selection of the returning timing of thread clamp to standby position</p>  : Normal  : Return to the retracted position at the end of sewing ; Move to the standby position when the work clamp switch is pressed <p>* This memory switch is displayed only for the LK-1903BBS, LK-1900BB.</p>			
K096	<p>Shorter-thread remaining type thread trimmer actuation delay time</p> <p>Length of time to be elapsed from the turning-ON of the thread waste suction nozzle/thread waste suction to the turning-ON of the shorter-thread remaining type thread trimmer</p>  <p>* This memory switch is displayed only for the LK-1903BBS, LK-1900BB.</p>	0 to 1000ms	10	10
K097	<p>Shorter-thread remaining type thread trimmer actuation time</p> <p>Length of time to be elapsed from the turning-ON of the shorter-thread remaining type thread trimmer to the turning-OFF of it</p>  <p>* This memory switch is displayed only for the LK-1903BBS, LK-1900BB.</p>	0 to 1000ms	10	50
K098	<p>Work clamp lifting delay time for shorter-thread remaining type thread trimmer</p> <p>Length of time to be elapsed from the turning-ON of the shorter-thread remaining type thread trimmer to the start of lifting of the work clamp foot</p>  <p>* This memory switch is displayed only for the LK-1903BBS, LK-1900BB.</p>	0 to 1000ms	10	50
K099	<p>Y travel amount of material feed for shorter-thread remaining type thread trimmer</p> <p>Y travel amount of material feed from the last stitch before the actuation of the shorter-thread remaining type thread trimmer</p>  <p>* This memory switch is displayed only for the LK-1903BBS, LK-1900BB.</p>	-3.0 to 3.0	0.1	<p>For the LK-1900BB: 0.6 For the LK-1903BB: 0.9</p>



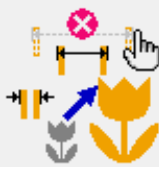

No.	Item	Setting range	Edit unit	Initial display
K100	<p>X travel amount of material feed for shorter-thread remaining type thread trimmer actuation</p> <p>X travel amount of material feed from the last stitch before the actuation of the shorter-thread remaining type thread trimmer</p>  <p>* This memory switch is displayed only for the LK-1903BBS, LK-1900BB.</p>	-3.0 to 3.0	0.1	<p>For the LK-1900BB: 0.6</p> <p>For the LK-1903BB: 0</p>
K101	<p>Number of driving pulses of presser wiper at the time of reverse rotation</p> <p>Adjustment of the wiper operation on the thread trimmer's even-numberth actuation in a pattern</p> 	-20 to 20	1	7
K102	<p>Selection of use of 2-holed/3-holed button pattern</p>  : Use of the patterns is prohibited  : Use of the patterns is permitted <p>* This memory switch is displayed only for the LK-1903BBS, LK-1900BB.</p>	—	—	
K150	<p>Selection of prohibition of head safety switch input</p>  : Normal  : Prohibited	—	—	
K241	<p>Model classification</p>  <p>0 : LK-1900BSS 1 : LK-1900BHS 2 : LK-1900BFS 3 : LK-1900BMS 4 : LK-1901BSS 5 : LK-1902BSS 6 : LK-1902BHS 7 : LK-1903BSS-301 8 : LK-1903BSS-302 9 : LK-1903BSS-311/BR35 10 : LK-1903BSS-312/BR35 11 : LK-1900BWS 12 : LK-1900BB 13 : LK-1900BBF 14 : LK-1903BBS301 15 : LK-1903BBS302</p>	0 to 15	1	<p>Initial display is the set value on the left side depending on the model.</p>

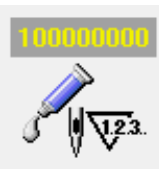



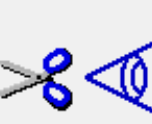

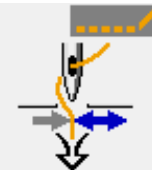

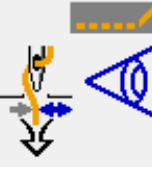
24. ERROR CODE LIST









Error code	Display	Description of error	Display message	How to recover	Place of recovery
E001		Data has been initialized. (EEPROM of MAIN CPU)	Data is initialized. (EEPROM of MAIN CPU)	Turn OFF the power.	
E007		Machine-lock Main shaft of the sewing machine does not rotate due to some trouble.	Machine is locked.	Turn OFF the power.	
E008		Head connector abnormality Memory of machine head cannot be read	Undefined head is selected.	Turn OFF the power.	
E010		Pattern No. error Pattern No. which is backed up is not registered to data ROM, or setting of reading inoperative is performed.	Specified pattern does not exist.	Possible to re-enter after reset.	Previous screen
E011		External media not inserted External media is not inserted.	Media is not inserted.	Possible to re-enter after reset.	Previous screen
E012		Read error Data read from external media cannot be performed.	Data cannot be read.	Possible to re-start after reset.	Previous screen
E013		Write error Data write from external media cannot be performed.	Data cannot be written.	Possible to re-start after reset.	Previous screen
E015		Format error Format cannot be performed.	Formatting is impossible.	Possible to re-start after reset.	Previous screen
E016		External media capacity over Capacity of external media is short.	Capacity is insufficient. (Media)	Possible to re-start after reset.	Previous screen









Error code	Display	Description of error	Display message	How to recover	Place of recovery
E017		Machine memory capacity over Machine memory capacity is insufficient.	Capacity is insufficient. (Machine)	Possible to re-start after reset.	Previous screen
E019		File size over File is too large.	Pattern data is too large. (Approx. 20,000 stitches)	Possible to re-start after reset.	Previous screen
E024		Pattern data size over Memory size is over.	Memory size to large.	Possible to re-start after reset.	Data input screen
E027		Read error Data read from server cannot be performed.	Data cannot be read.	Possible to re-start after reset.	Previous screen
E028		Write error Data write from server cannot be performed.	Data cannot be written.	Possible to re-start after reset.	Previous screen
E029		Lid of media slot is open.	Cover of Media slot is open.	Possible to re-start after reset.	Previous screen
E030		Needle bar position error Needle bar is not in the specified position.	Needle is not in a proper position.	Turn hand pulley and return the needle bar to the specified position.	Previous screen
E031		Air pressure drop Air pressure is dropped.	Low air pressure.	Supply air and reset the sewing machine. Then, the operation is enabled again.	Data input screen
E032		File compatibility error File cannot be read.	File cannot be read.	Possible to re-start after reset.	Data input screen
E040		Sewing area over	Move limit is exceeded.	Possible to re-start after reset.	Sewing screen



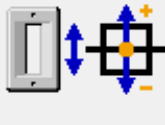
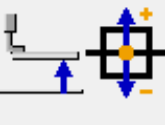

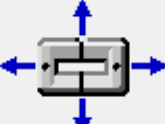

Error code	Display	Description of error	Display message	How to recover	Place of recovery
E043		Max. pitch over error Sewing pitch exceeds 10mm.	Max. Pitch is exceeded.	Possible to re-start after reset.	Data input screen
E045		Pattern data error	Pattern data no good.	Possible to re-start after reset.	Data input screen
E050		Stop switch When stop switch is pressed during machine running.	Temporary stop switch is pressed.	Possible to re-start after reset.	Step screen
E061		Memory switch data error Memory switch data is broken or revision is old.	Memory switch data error	Turn OFF the power.	
E204		USB connection error With the number of times of sewing has reached 10 or more, with a USB device connected to the sewing machine	Never connect USB storage device to the machine during sewing.	Possible to re-start after reset.	Sewing screen
E220		Grease-up warning At the time of operation of 100 million stitches	Important : Grease is running out. Replace grease machine.	Possible to re-start after reset.	Data input screen
E221		Grease-up error At the time of operation of 120 million stitches The sewing machine is put in the sewing impossible status. It is possible to clear with memory switch U245 → Refer to “9. PERFORMING RELEASE OF GREASE-UP ERROR” p.25 .	Important : Grease has run out. Replace grease machine.	Possible to re-start after reset.	Data input screen
E302		Head tilt confirmation When head tilt sensor is OFF.	Head is tilted.	Possible to re-start after reset.	Previous screen

Error code	Display	Description of error	Display message	How to recover	Place of recovery
E303		Z phase detection error Detection of upper dead point of the sewing machine cannot be performed.	UP position of sewing machine motor cannot be detected. (Woodruff plate signal of sewing machine motor)	Turn OFF the power.	
E305		Thread clamp position error Thread clamp unit is not in the regular position.	Thread clamp sensor cannot be detected.	Turn OFF the power.	
E396		Shorter-thread remaining type thread trimmer cylinder error The shorter-thread remaining thread trimmer cylinder fails to operate.	Shorter thread trimming cylinder fails to operate	Turn OFF the power switch. Check whether the air pressure is adequate and whether the shorter-thread remaining thread trimming cylinder sensor and MAIN PCB CN53 have loosened or fallen off.	
E397		Suction nozzle cylinder error The suction nozzle cylinder fails to operate.	Suction nozzle cylinder fails to operate	Turn OFF the power switch. Check whether the air pressure is adequate and whether the suction nozzle cylinder sensor and MAIN PCB CN54 have loosened or fallen off.	
E398		Shorter-thread remaining type thread trimmer cylinder sensor error The shorter-thread remaining type thread trimmer cylinder sensor fails to detect	Shorter thread trimming knife has not returned	Turn OFF the power switch. Check whether the air pressure is adequate and whether the shorter-thread remaining thread trimming cylinder sensor and MAIN PCB CN53 have loosened or fallen off.	
E399		Suction nozzle cylinder sensor error The suction nozzle cylinder sensor fails to detect.	Nozzle has not returned	Turn OFF the power switch. Check whether the air pressure is adequate and whether the suction nozzle cylinder sensor and MAIN PCB CN54 have loosened or fallen off.	

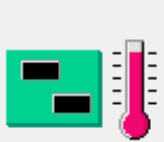
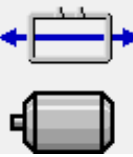

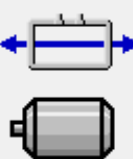
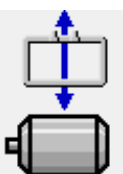





Error code	Display	Description of error	Display message	How to recover	Place of recovery
E401		Copy disapproval error Copy cannot be performed since the pattern has been already registered.	Cannot copy.	Possible to re-start after reset.	Previous screen
E402		Pattern button delete disapproval error The button cannot be deleted since it is used for the cycle data.	Data cannot be deleted since it is used for cycle data.	Possible to re-start after reset.	Previous screen
E403		New creation disapproval error New creation cannot be performed since the pattern has been already registered.	This No. is already used.	Possible to re-start after reset.	Previous screen
E404		Pattern No. selection disapproval error The selected pattern No. cannot be found.	This No. cannot be found.	Possible to re-start after reset.	Previous screen
E405		Pattern delete error The pattern cannot be deleted since it is used for the pattern button.	Data cannot be deleted since it is used for direct pattern.	Possible to re-start after reset.	Previous screen
E435		Set value exceeds the range.	Set value exceeds the range.	Possible to re-start after reset.	Previous screen
E703		Panel is connected to the sewing machine which is not supposed. (Machine type error) When the machine type code of system is not proper in the initial communication.	Model of sewing machine is different from that of panel.	Possible to rewrite program after pressing down communication switch.	Communication screen
E704		Inconsistency of system version System software version is inconsistent in the initial communication.	Version of program incompatible.	Possible to rewrite program after pressing down communication switch.	Communication screen

Error code	Display	Description of error	Display message	How to recover	Place of recovery
E730		Main shaft motor encoder is defective or lacking for phases. When encoder of the sewing machine motor is abnormal.	Sewing machine motor is defective. (Encoder A and B phases)	Turn OFF the power.	
E731		Main motor hole sensor is defective or position sensor is defective. Hole sensor or position sensor of the sewing machine motor is defective.	Sewing machine motor is defective. (Encoder U, V, and W phases)	Turn OFF the power.	
E733		Reverse rotation of main shaft motor When the sewing machine motor rotates in the reverse direction.	Sewing machine motor runs in the reverse direction.	Turn OFF the power.	
E811		Overvoltage When input power is more than the specified value.	Input voltage is too high. (Check input voltage.)	Turn OFF the power.	
E813		Low voltage When input power is less than the specified value.	Input voltage is too low. (Check input voltage.)	Turn OFF the power.	
E901		Main shaft motor IPM abnormality When SERVO CONTROL p. c. b. is abnormal.	SDC p.c.b. is defective. (IPM)	Turn OFF the power.	
E903		Stepping motor power abnormality When stepping motor power of SERVO CONTROL p. c. b. fluctuates more than $\pm 15\%$.	Power of SDC p.c.b. is defective. (Stepping motor power 85 V)	Turn OFF the power.	
E904		Solenoid power abnormality When solenoid power of SERVO CONTROL p. c. b. fluctuates more than $\pm 15\%$.	Power of SDC p.c.b. is defective. (Solenoid power 33 V)	Turn OFF the power.	



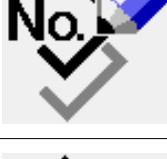

Error code	Display	Description of error	Display message	How to recover	Place of recovery
E905		Heat sink temperature for SERVO CONTROL p. c. b. abnormality Turn ON the power again after taking overheat time of SERVO CONTROL p. c. b.	Temperature of SDC P.C.B is to high.	Turn OFF the power.	
E907		X feed motor origin retrieval error When origin sensor signal is not inputted at the time of origin retrieval motion.	Origin of X motor cannot be found. (X origin sensor)	Turn OFF the power.	
E908		Y feed motor origin retrieval error When origin sensor signal is not inputted at the time of origin retrieval motion.	Origin of Y motor cannot be found. (Y origin sensor)	Turn OFF the power.	
E910		Presser motor origin retrieval error When origin sensor signal is not inputted at the time of origin retrieval motion.	Origin of presser thread trimmer motor cannot be found. (Presser thread trimmer origin sensor)	Turn OFF the power.	
E913		Thread clamp origin retrieval error When origin sensor signal is not inputted at the time of origin retrieval motion.	Origin of thread clamp motor cannot be found. (Thread clamp origin sensor)	Turn OFF the power.	
E914		Feed defective error Timing lag between feed and main shaft occurs.	X/Y feed trouble is detected.	Turn OFF the power.	
E915		Communication abnormality between operation panel and MAIN CPU When abnormality occurs in data communication.	Communication is impossible. (Panel - MAIN p.c.b.)	Turn OFF the power.	
E916		Communication abnormality between MAIN CPU and main shaft CPU When abnormality occurs in data communication.	Communication is impossible. (MAIN p.c.b. - Sewing machine motor p.c.b.)	Turn OFF the power.	
E917		Communication failure between operation panel and personal computer When abnormality occurs in data communication.	Communication is impossible. (Panel - PC)	Possible to re-start after reset.	

Error code	Display	Description of error	Display message	How to recover	Place of recovery
E918		Overheat of MAIN p.c.b. Turn ON the power again after some time has passed.	Main p.c.b. temperature to high.	Turn OFF the power.	
E926		X motor position slip error	X-feed motor position is off.	Turn OFF the power.	1. Step screen 2. Sewing screen 3. -----
E927		Y motor position slip error	Y-feed motor position is off.	Turn OFF the power.	1. Step screen 2. Sewing screen 3. -----
E929		Thread clamp motor out-of-position error	Thread clamp motor position is off.	Turn OFF the power.	
E931		X motor overload error	X-feed motor overload is excessive.	Turn OFF the power.	
E932		Y motor overload error	Y-feed motor overload is excessive.	Turn OFF the power.	
E934		Thread clamp motor overload error	Thread clamp motor overload is excessive.	Turn OFF the power.	
E943		MAIN CONTROL p.c.b. trouble When data writing to MAIN CONTROL p.c.b. cannot be performed	MAIN P.C.B. is defective.	Turn OFF the power.	
E946		HEAD RELAY p.c.b. trouble When data writing to HEAD RELAY p.c.b. cannot be performed	Head P.C.B. is defective.	Turn OFF the power.	

25. MESSAGE LIST

Message No.	Display	Display message	Description
M520		Erasing is performed. OK ?	Confirmation of erasing of users' pattern Erasing is performed. O.K. ?
M521		Erasing is performed. OK ?	Confirmation of erasing of pattern button Erasing is performed. O.K. ?
M522		Erasing is performed. OK ?	Confirmation of erasing of cycle pattern Erasing is performed. O.K. ?
M523		Pattern data is not stored. Erasing is OK?	Erase confirmation of backup data Pattern data is not stored in memory. Erase is O.K. ?
M528		Overwriting is performed. OK ?	Confirmation of overwriting of users' pattern Overwriting is performed. O.K. ?
M529		Overwriting is performed. OK ?	Confirmation of overwriting of media Overwriting is performed. O.K. ?
M530		Overwriting is performed. OK ?	Vector data/sewing standard format data of panel Overwriting is performed. O.K. ?
M531		Overwriting is performed. OK ?	Vector data/sewing standard format data of media data Overwriting is performed. O.K. ?
M532		Overwriting is performed. OK ?	Vector data/sewing standard format data on PC Overwriting is performed. O.K. ?

Message No.	Display	Display message	Description
M534		Overwriting is performed. OK ?	Confirmation of overwriting of adjustment data and all sewing machine data of media Overwriting is performed. O.K. ?
M535		Overwriting is performed. OK ?	Confirmation of overwriting of adjustment data and all sewing machine data of PC Overwriting is performed. O.K. ?
M537		Deleting is performed. OK ?	Confirmation of deletion of thread tension command Deletion is performed. O.K. ?
M542		Formatting is performed. OK ?	Confirmation of formatting Formatting is performed. O.K. ?
M544		Data does not exist.	Data corresponding to panel does not exist. Data does not exist.
M545		Data does not exist.	Data corresponding to media does not exist. Data does not exist.
M546		Data does not exist.	Data corresponding to PC does not exist. Data does not exist.
M547		Overwriting cannot be performed since data exists.	Over writing prohibition of pattern data Overwriting cannot be performed since data exists.
M548		Overwriting cannot be performed since data exists.	Overwriting prohibition of media data Overwriting cannot be performed since data exists.

Message No.	Display	Display message	Description
M549		Overwriting cannot be performed since data exists.	Overwriting prohibition of data on PC Overwriting cannot be performed since data exists.
M653		Formatting is performed.	During formatting Formatting is performed.
M669		Data is being read.	During reading data Data is being read.
M670		Data is being written.	During writing data Data is being written.
M671		Data is being converted.	During converting data Data is being converted.

26. USING COMMUNICATION FUNCTION

Communication function can download the sewing data created with other sewing machine, creation of sewing data and sewing data created by editing device PM-1 to the sewing machine. In addition, it is also possible to upload the aforementioned data on a medium.

A medium and a USB port are provided as communication media.

26-1 Handling possible data

The data format that is supported is as shown in the table below.

Data name		Extension	Description of data
Vector format data		VD00xxx.VDT	Data of needle entry point created with PM-1. Format of the data which can be used in common among JUKI sewing machines.

xxx : File No.

[Folder structure of the media]

Store each file in the folders below of the media.

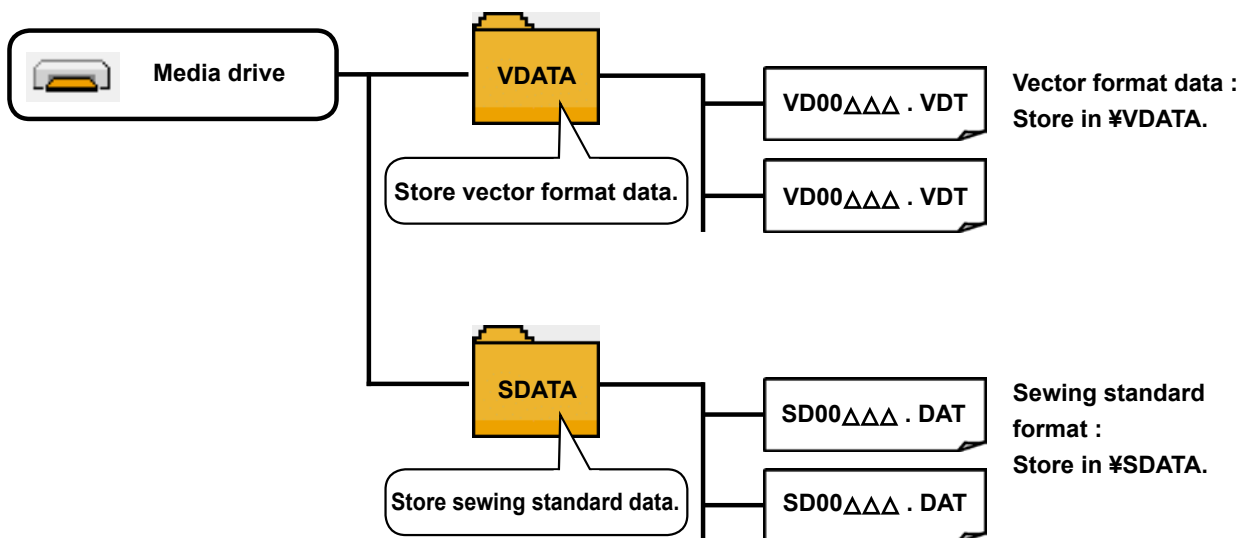

Data that are not stored in the directories above cannot be read. So, be careful.

26-2 Performing communication by using the media

■ Inserting the CompactFlash (TM)

- 1) Turn the label side of the CompactFlash(TM) to this side (place the notch of the edge to the rear.) and insert the part that has a small hole into the panel.
- 2) After completion of setting of the media, close the cover. If the cover cannot be closed since the memory media comes in contact it, check the following:
 - Check that the media is securely pressed until it goes no further.
 - Check that the inserting direction of the media is proper.

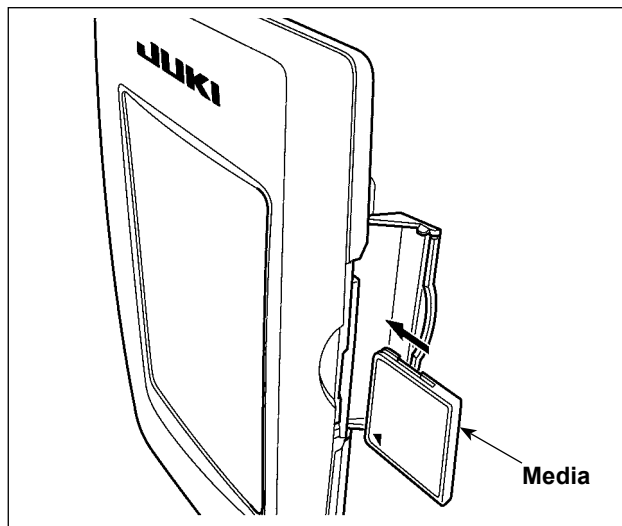

1. When the inserting direction is wrong, panel or media may be damaged.
2. Do not insert any item other than the CompactFlash (TM).
3. The media slot in the IP-420 accommodates to the CompactFlash (TM) of 2 GB or less.
4. The media slot in the IP-420 supports the FAT16 which is the format of the CompactFlash (TM). FAT32 is not supported.
5. Be sure to use the CompactFlash (TM) which is formatted with IP-420. For the formatting procedure of the CompactFlash (TM), see "[26-3 Performing format](#)" p.87 .

■ Removing the CompactFlash (TM)

1) Hold the panel by hand, open the cover, and press the media ② removing lever ①. The media is eject.



When the lever ① is strongly pressed, the media ② may be broken by protruding and falling.

2) When the media ② is drawn out as it is, removing is completed.

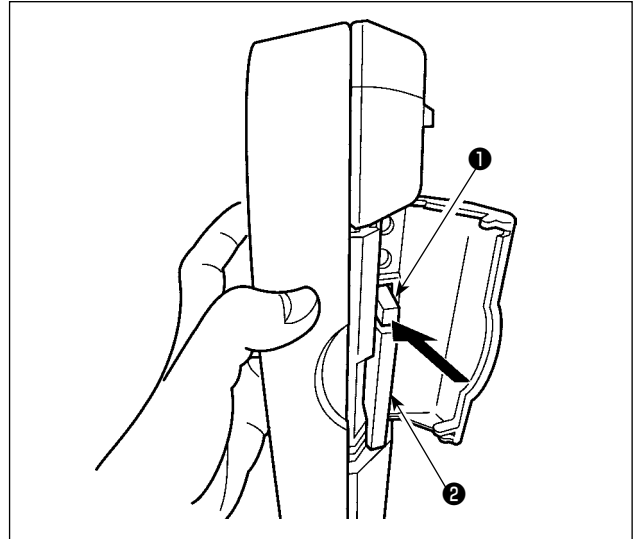

[USB port]

■ Inserting a device into the USB port

Slide the top cover and insert the USB device into the USB port. Then, copy data to be used from the USB device onto the main body.

After completion of copying the data, remove the USB device.

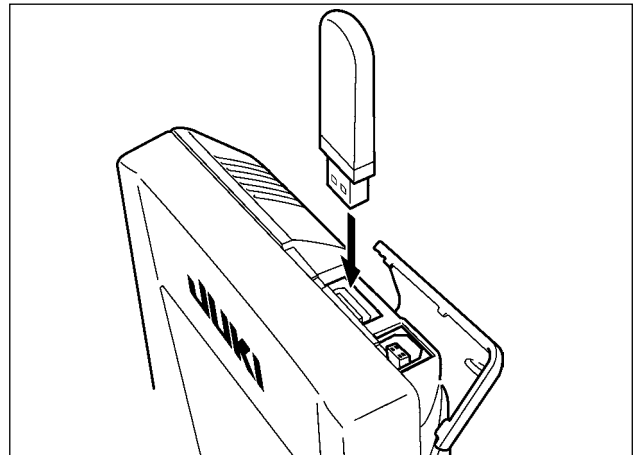

■ Disconnecting a device from the USB port

Remove the USB device. Put the cover back in place.

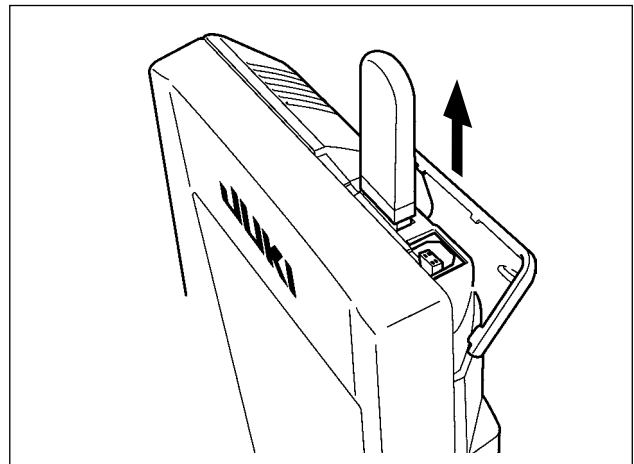

Cautions when using the media



- Do not wet or touch it with wet hands. Fire or electric shock will be caused.
- Do not bend, or apply strong force or shock to it.
- Never perform disassembling or remodeling of it.
- Do not put the metal to the contact part of it. Data may be disappeared.
- Avoid storing or using it in the places below.

Place of high temperature or humidity / Place of dew condensation /

Place with much dust / Place where static electricity or electrical noise is likely to occur

① Precautions to be taken when handling USB devices

- Do not leave the USB device or USB cable connected to the USB port while the sewing machine is in operation. The machine vibration can damage the port section resulting in loss of data stored on the USB device or breakage of the USB device or sewing machine.
- Do not insert/remove a USB device during reading/writing a program or sewing data. It may cause data breakage or malfunction.
- When the storage space of a USB device is partitioned, only one partition is accessible.
- Some type of the USB device may not be properly recognized by this sewing machine.
- JUKI does not compensate for loss of data stored on the USB device caused by using it with this sewing machine.
- When the panel displays the communication screen or pattern data list, the USB drive is not recognized even if you insert a medium into the slot.
- For USB devices and media such as CF(TM) cards, only one device/medium should be basically connected/inserted to/into the sewing machine. When two or more devices/media are connected/inserted, the machine will only recognize one of them. Refer to the USB specifications.
- Insert the USB connector into the USB terminal on the IP panel until it will go no further.
- Do not turn the power OFF while the data on the USB flash drive is being accessed.

② USB specifications

- Conform to USB 1.1 standard
- Applicable devices *1___ Storage devices such as USB memory, USB hub, FDD and card reader
- Not-applicable devices __ CD drive, DVD drive, MO drive, tape drive, etc.
- Format supported _____ FD (floppy disk) FAT 12 Others (USB memory, etc.), FAT 12, FAT 16, FAT 32
- Applicable medium size _ FD (floppy disk) 1.44MB, 720kBOthers (USB memory, etc.), 4.1MB ~ (2TB)
- Recognition of drives __ For external devices such as a USB device, the device which is recognized first is accessed. However, when a medium is connected to the built-in media slot, the access to that medium will be given the highest priority. (Example: If a medium is inserted into the media slot even when the USB memory has already been connected to the USB port, the medium will be accessed.)
- Restriction on connection _ Max. 10 devices (When the number of storage devices connected to the sewing machine has exceeded the maximum number, the 11th storage device and beyond will not be recognized unless they are once disconnected and re-connected.)
- Consumption current ___ The rated consumption current of the applicable USB devices is 500 mA at the maximum.

*1: JUKI does not guarantee operation of all applicable devices. Some device may not operate due to a compatibility problem.

26-3 Performing format

In case of re-formatting the media, be sure to perform it with IP-420. The media formatted with the personal computer cannot be read with IP-420.

① Display the media format screen.

When **M** key is held pressed for three seconds, MEDIA FORMAT button  **A** is displayed on the screen. When this button is pressed, the media format screen is displayed.

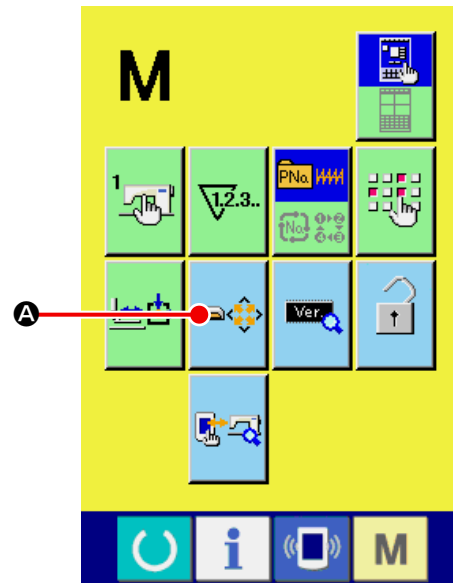

② Start formatting of the media.

Set the media you desire to format to the media slot, close the cover, press ENTER button **B** and formatting starts.

Save necessary data in the media to the other medium before formatting. When formatting is performed, the inside data are erased.

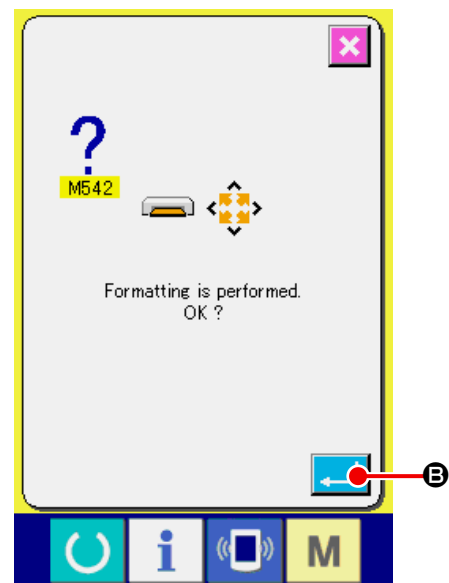

When two or more media are connected to the sewing machine, the medium to be formatted is determined by the predetermined priority order.

High ← Low

CF(TM) slot ← USB device 1 ← USB device 2 ←

When a CompactFlash (TM) is inserted in the CF(TM) slot, the CompactFlash (TM) will be formatted according to the priority order as shown above.

Refer to the USB specifications for the priority order of access.



26-4 Performing communication

① Performing communication by using the media

For handling way of the media, read **“26. USING COMMUNICATION FUNCTION” p.83** .

② Performing communication by using USB

Data can be sent/received to/from a personal computer or the like, by means of a USB cable.



If the contact part becomes dirty, failure of contact will be caused. Do not touch by hand, and control so that dust, oil or other foreign material does not adhere to it. In addition, the inside element is damaged by static electricity or the like. So, be very careful when handling.

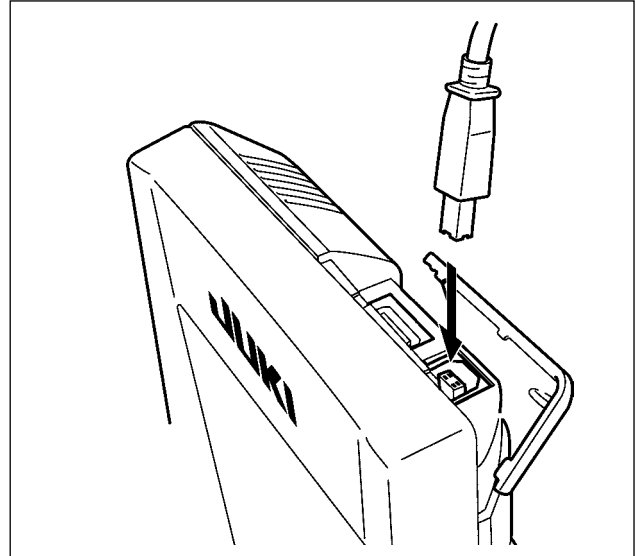

26-5 Take-in of the data

① Display the communication screen.

When communication switch  **A** of switch seat section is pressed in the data input screen, the communication screen is displayed.

② Select the communication procedure.

There are four communication procedures as described below.

- B** : Writing data from media to panel
- C** : Writing data from personal computer (server) to panel
- D** : Writing data from panel to media
- E** : Writing data from panel to personal computer (server)

Select the button of communication procedure you desire.

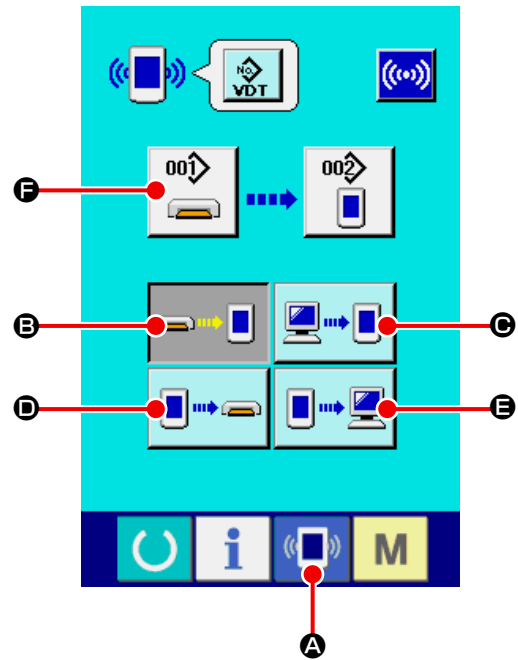

③ Select the data No.

When  **F** is pressed, the writing file selection screen is displayed.

Input the file No. of the data you desire to write. For the file No., input the numerals of the part xxx of VD00xxx .vdt of the file name.

Designation of the pattern No. of writing destination can be performed in the same way.

When the writing destination is the panel, pattern Nos. which have not been registered are displayed.

④ Determine the data No.

When ENTER button  **G** is pressed, the data No. selection screen is closed and the selection of the data No. has been completed.

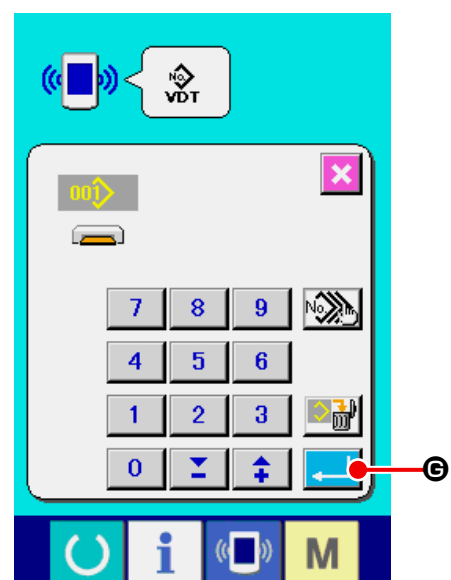

⑤ **Start communication.**

When COMMUNICATION START button  is pressed, the data communication starts. The during communication screen is displayed during communication and the screen returns to the communication screen after the end of communication.

 **Do not open the cover during reading the data. Data may not be read in.**

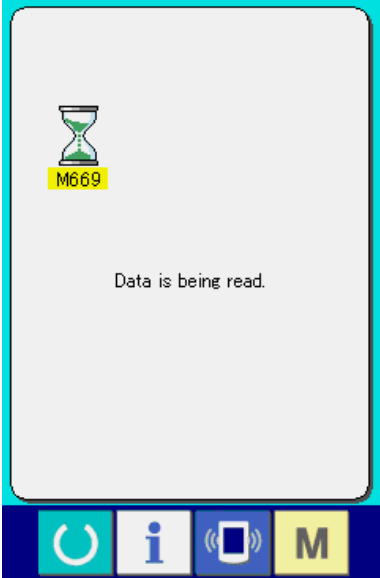
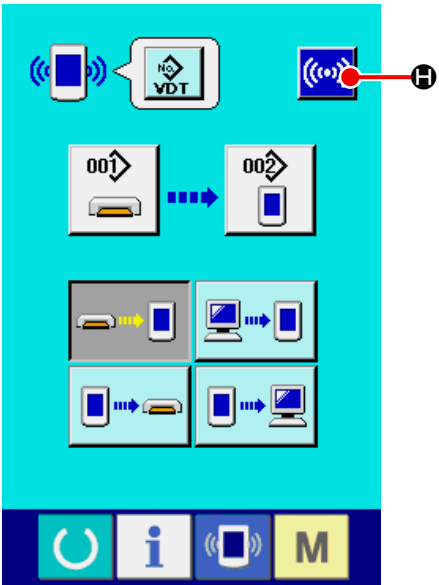

26-6 Taking in plural data together

It is possible for the vector data and the sewing standard format data to select the data to be written more than one and write them together. Pattern No. of writing destination will become the same No. of the selected data No.



It is not possible for the No. after No. 201 of media to select plural No.

① Display the writing file selection screen.

When PLURAL SELECTION button  **A** is pressed, the data No. plural selection screen is displayed.

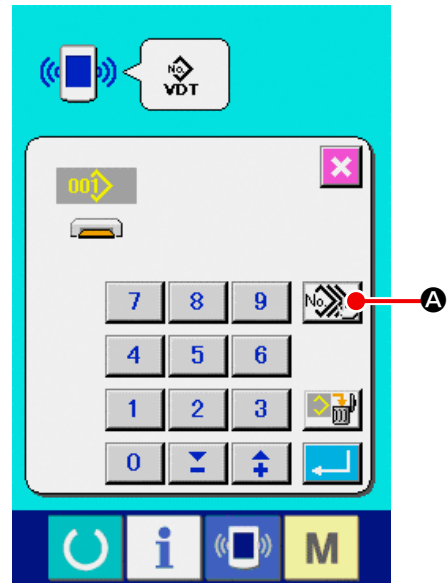

② Perform the data No. selection.

Since the list of existing data file numbers is displayed, press FILE No. button **B** you desire to write. It is possible to invert the selected state of the button with INVERSION button  **C**.

③ Determine the data No.

When ENTER button  **D** is pressed, the data No. plural selection screen is closed and the data selection ends.

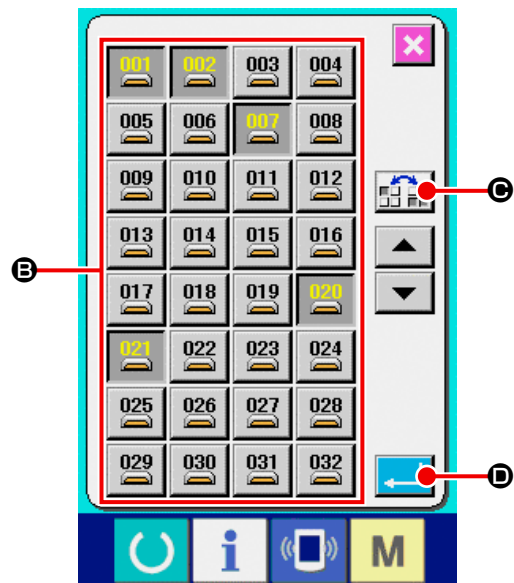

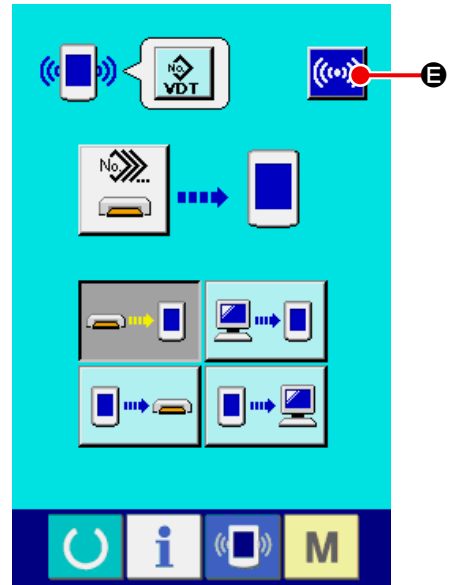

④ **Start the communication.**

When COMMUNICATION START button  **E** is pressed, the data communication starts.

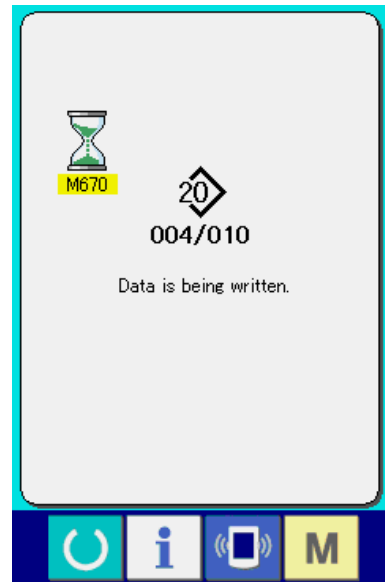

Data No. during communication, total number of writing data and number of data that have ended the data communication are displayed in the during communication screen.



* When performing writing to the pattern No. which already exists, the overwriting confirmation screen is displayed before writing. When performing overwriting, press ENTER button  **F**. When performing overwriting all without displaying the overwriting confirmation screen, press OVERWRITING button  **G** in all cases.

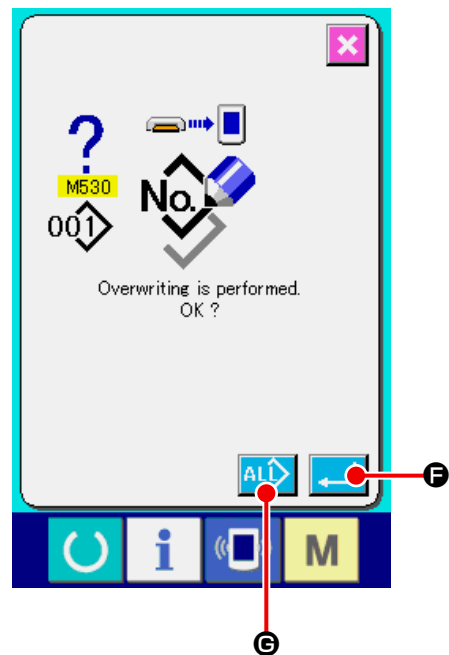

27. INFORMATION FUNCTION

There are three functions below in the information function.

- 1) Oil replacement time, needle replacement time, cleaning time, etc. are designated and the warning notice is performed when the designated time has passed.
→ Refer to **“27-1 Observing the maintenance inspection information” p.93** and **“27-2 Inputting the inspection time” p.95** .
- 2) Speed can be checked at a glance and the target achieving consciousness as a line or group is increased as well by the function to display the target output and the actual output.
→ Refer to **“27-4 Observing the production control information” p.97** and **“27-5 Performing setting of the production control information” p.100** .
- 3) Information on machine working ratio, pitch time, machine time and machine speed can be displayed from the working state of the sewing machine.
→ Refer to **“27-6 Observing the working measurement information” p.104** .

In addition, information on plural sewing machines can be controlled by the server when this function is used by connecting SU-1 (sewing machine data server utility) with the sewing machines.

27-1 Observing the maintenance inspection information

① Display the information screen.

When information key  **A** of the switch seat section is pressed in the data input screen, the information screen is displayed.

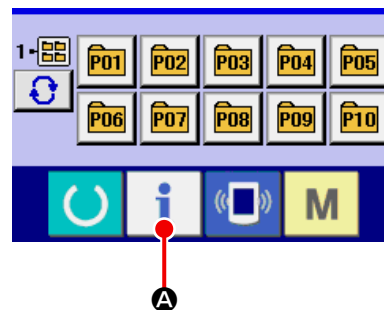

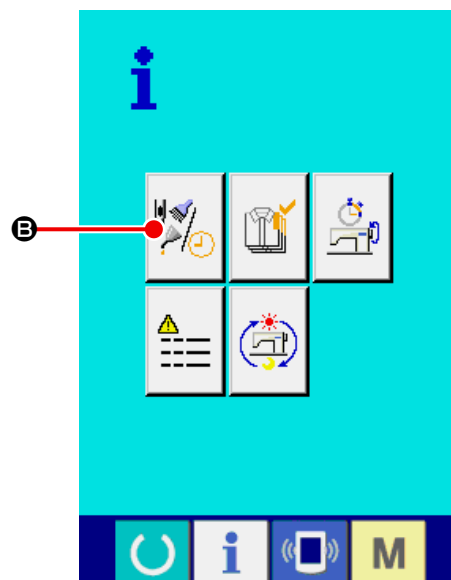

② Display the maintenance information screen.

Press maintenance inspection information screen display button  **B** in the information screen.



Information on the following three items is displayed in the maintenance inspection information screen.

- Needle replacement (1,000 stitches) : 
- Cleaning time (hour) : 
- Oil replacement time (hour) : 

The interval to inform button **C** of the inspection for each item is displayed at **D**, and the remaining time up to the replacement is displayed at **E**.

In addition, remaining time up to the replacement can be cleared.

③ Perform clearing remaining time up to the replacement.

When button **C** of the item you desire to clear is pressed, the time of replacement clear screen is displayed. When CLEAR button **C** **C** is pressed, the remaining time up to the replacement is cleared.

④ Display the threading diagram.

When threading button  **F** displayed in the maintenance inspection information screen is pressed, the needle thread threading diagram is displayed. Observe it when performing threading.

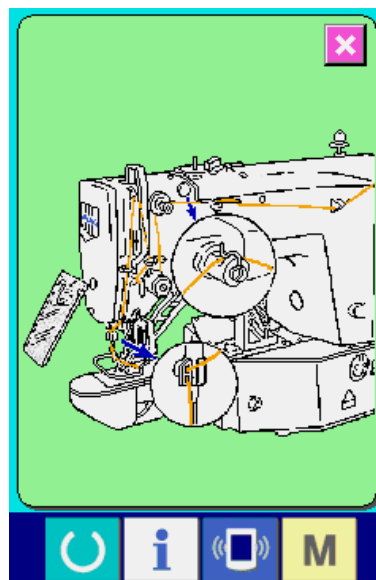
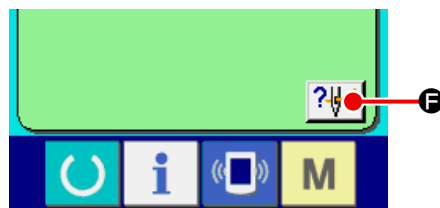
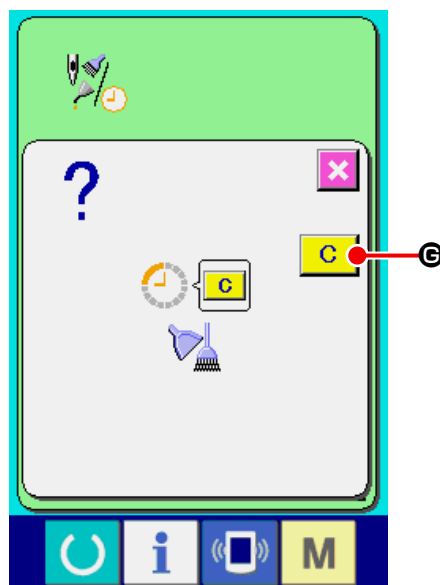
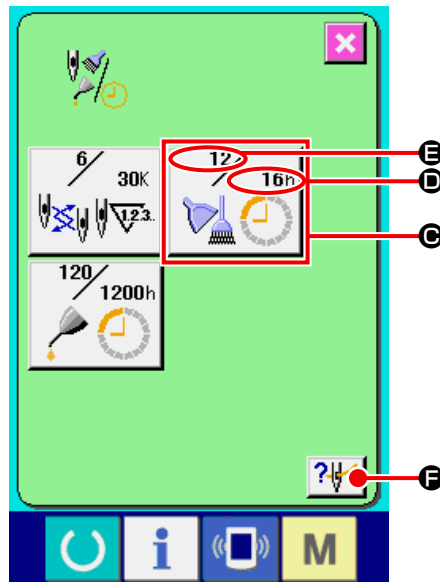

27-2 Inputting the inspection time

① Display the information screen (maintenance personnel level).

When information key  **A** of the switch seat section is pressed in the data input screen for approximately three seconds, information screen (maintenance personnel level) is displayed.

In case of the maintenance personnel level, the pictograph located on the upper left side changes from blue to orange, and five buttons are displayed.

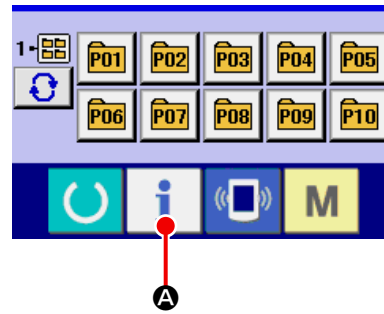

② Display the maintenance information screen.

Press maintenance inspection information screen display button  **B** in the information screen.

* For the two buttons displayed in the bottom stage at the time of the maintenance personnel level, refer to **“36. INFORMATION SCREEN OF THE MAINTENANCE PERSONNEL LEVEL”** p.137 .

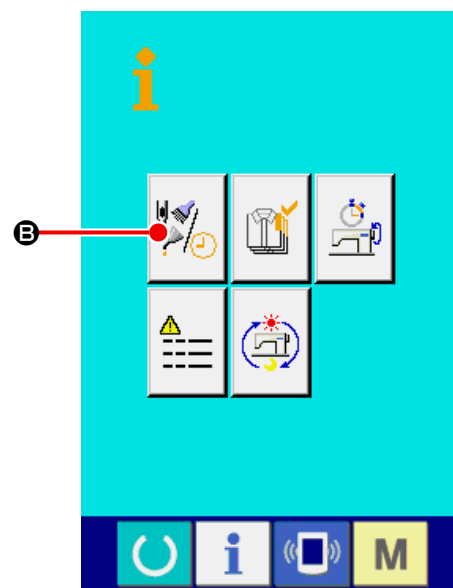

The same information as that in the normal maintenance inspection information screen is displayed in the maintenance inspection information screen.

When button **C** of the item you desire to change the inspection time is pressed, the inspection time input screen is displayed.

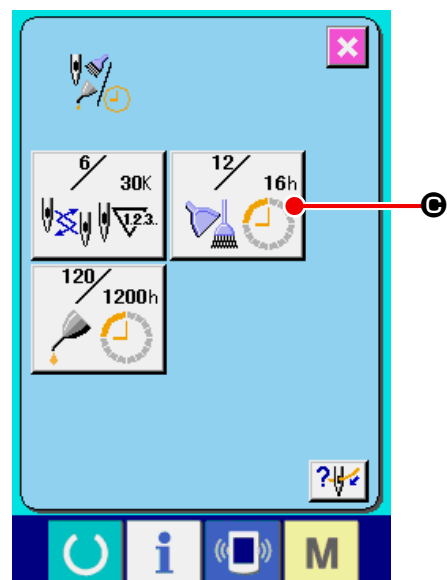

③ Input the inspection time.

When the inspection time is set to "0", the maintenance inspection function stops.

When clear button **C** **D** is pressed, the value returns to the initial value. The initial values of the inspection time of respective items are as follows.

- Needle replacement : 0 (1,000 stitches)
- Cleaning time : 0 (hour)
- Oil replacement time : 0 (hour)

When ENTER **↵** **E** button is pressed, the inputted value is determined.

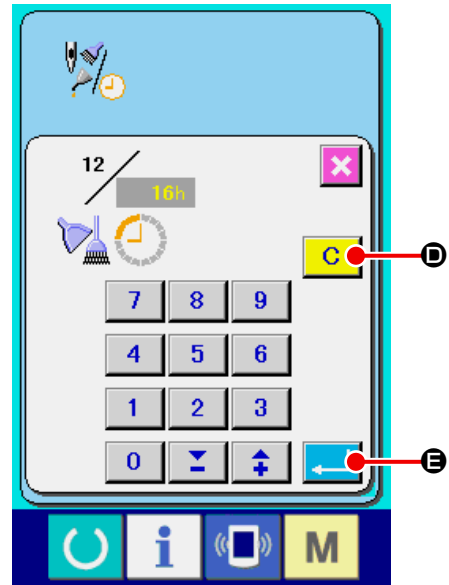

27-3 Releasing procedure of the warning

When the designated inspection time is reached, the warning screen is displayed.

In case of clearing the inspection time, press CLEAR button **C** **F**. The inspection time is cleared and the pop-up is closed. In case of not clearing the inspection time, press CANCEL button **X** **G** and close the pop-up. Every time one sewing is completed, the warning screen is displayed until the inspection time is cleared.

Warning Nos. of the respective items are as follows.

- Needle replacement : A201
- Cleaning time : A202
- Oil replacement time : A203

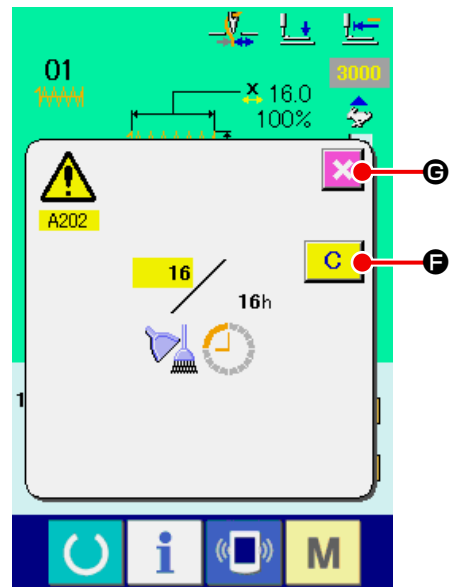

27-4 Observing the production control information

It is possible to designate the start, display the number of pieces of production from the start to the existing time, display the number of pieces of production target, etc. in the production control screen.

There are two kinds of display ways for the production control screen.

27-4-1 When displaying from the information screen

① Display the information screen.

When information key  **A** of the switch seat section is pressed in the data input screen, the information screen is displayed.

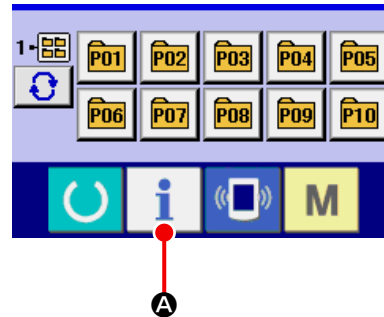

② Display the production control screen.

Press production control screen display button



B in the information screen. The production control screen is displayed.

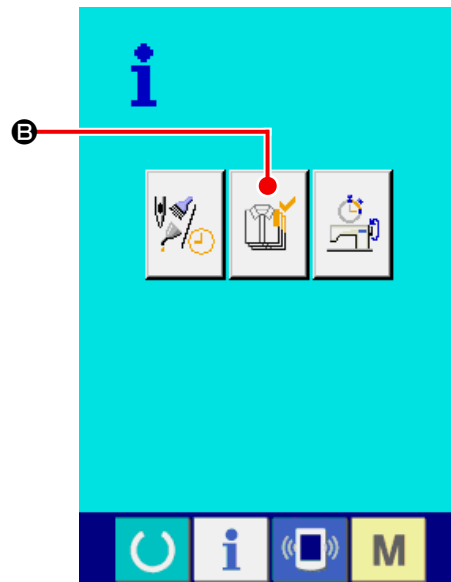

Information on the following 5 items is displayed in the production control screen.

A : Existing target value

Number of pieces of the target of products at the present time is automatically displayed.

B : Actual results value

Number of pieces of the sewn products is automatically displayed.

C : Final target value

Number of pieces of the final target of products is displayed.

Input the number of pieces referring to **“27-5 Performing setting of the production control information” p.100** .

D : Pitch time

Time (second) required for one process is displayed.

Input the time (unit : second) referring to **“27-5 Performing setting of the production control information” p.100** .

E : Number of times of thread trimming

Number of times of thread trimming per process is displayed.

Input the number of times of thread trimming referring **“27-5 Performing setting of the production control information” p.100** .

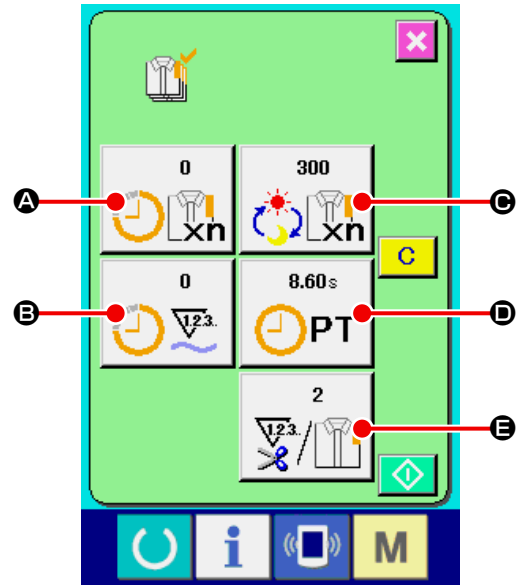

27-4-2 When displaying from the sewing screen

① Display the sewing screen.

When READY key  **A** of the switch seat section is pressed in the data input screen, the sewing screen is displayed.

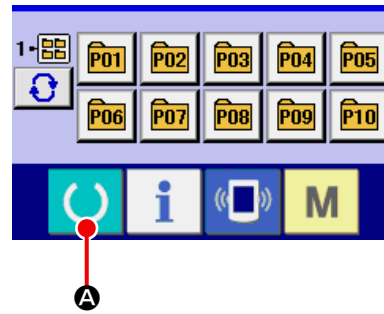

② Display the production control screen.

When information key  **B** of the switch seat section is pressed in the sewing screen, the production control screen is displayed.

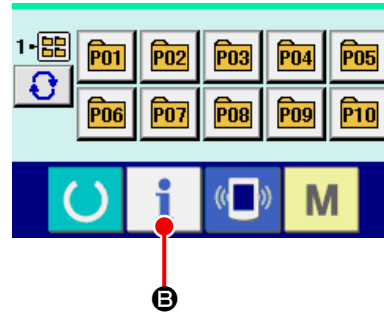

The contents and functions are common to “27-4-1 When displaying from the information screen” p.97 .

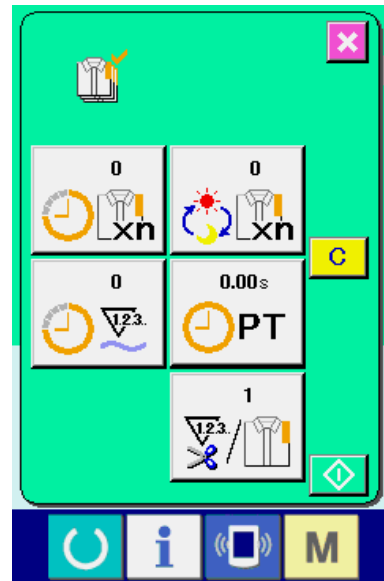

27-5 Performing setting of the production control information

① Display the production control screen.

Display the production control screen referring to “27-4 Observing the production control information” p.97 .

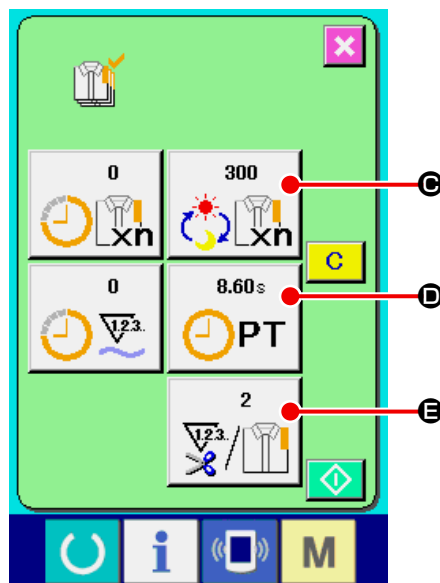

② Input the final target value.

First, input the number of pieces of the target of production in the process to which sewing is performed from now on. When final target value button  (C) is pressed, the final target value input screen is displayed. Input the value you desire with TEN keys or +/- keys (D) .

After the input, press ENTER button  (F) .

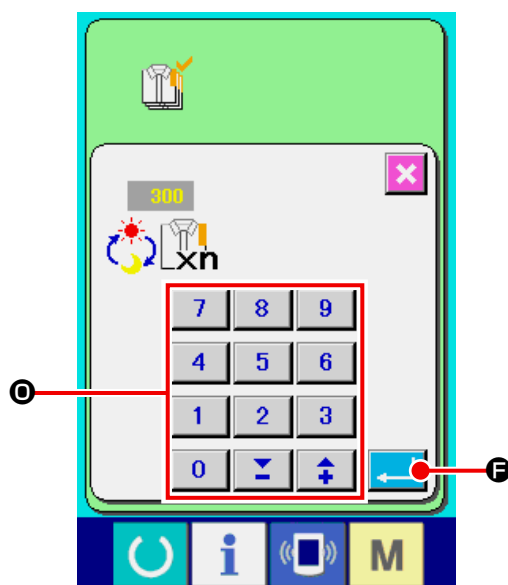

③ **Input the pitch time.**

Next, input the pitch time required for one process. When pitch time button  in the previous page is pressed, the pitch time input screen is displayed.

Input the value you desire with TEN keys or +/- keys  .

After inputting, press ENTER button   .

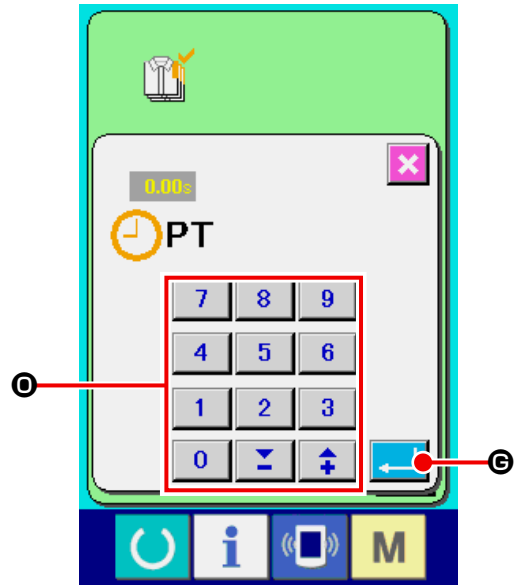

④ **Input the number of times of thread trimming.**

Next, input the number of times of thread trimming per process.

When number of times of thread trimming button  in the previous page is pressed, the number of times of thread trimming input screen is displayed.

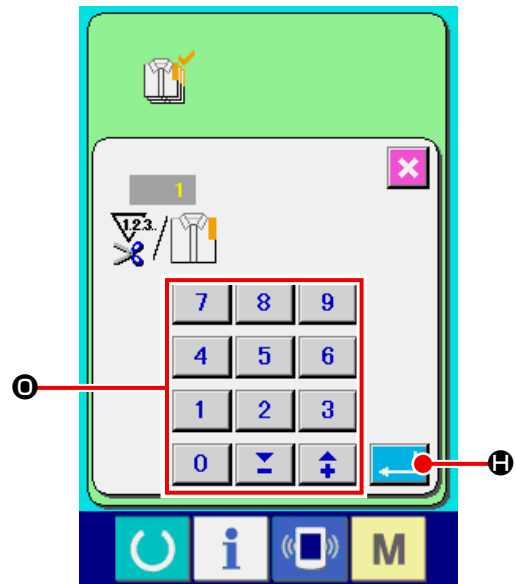

Input the value you desire with TEN keys or +/- keys  .

After inputting, press ENTER button   .



* When the input value is "0", count of the number of times of thread trimming is not performed. Use this function by connecting the external switch.



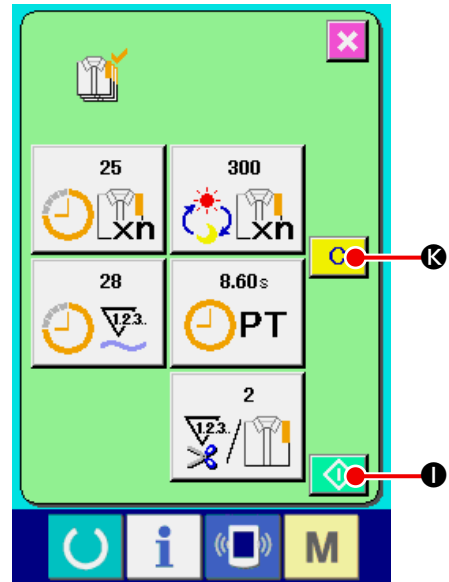

⑤ **Start the count of number of pieces of production.**



When START button   is pressed, the count of number of pieces of production is started.



⑥ **Stop the count.**

Display the production control screen referring to “[27-4 Observing the production control information](#)” p.97 .

When the count is being performed, STOP button   is displayed. When STOP button   is pressed, the count is stopped.

After the stop, START button is displayed at the position of STOP button. When continuing the count, press START button again. The counted value is not cleared until CLEAR button   is pressed.

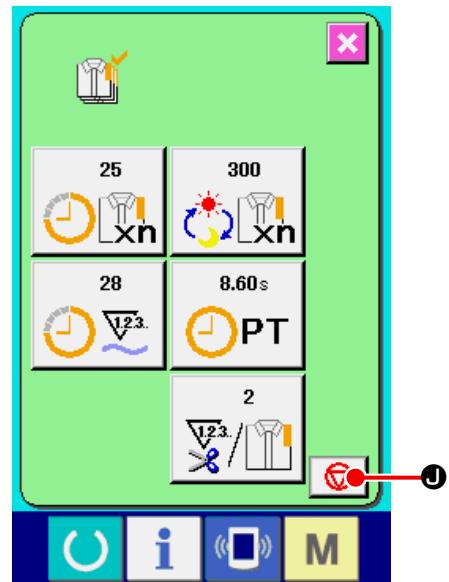

⑦ **Clear the counted value.**

When clearing the counted value, set the count to the stop state and press CLEAR button **C** **K**.

The value to be cleared is the present target value **L** and actual results value **M** only.

Caution CLEAR button **C** **K** is displayed only in case of stop state.

When CLEAR button **C** **K** is pressed, the clear confirmation screen is displayed.

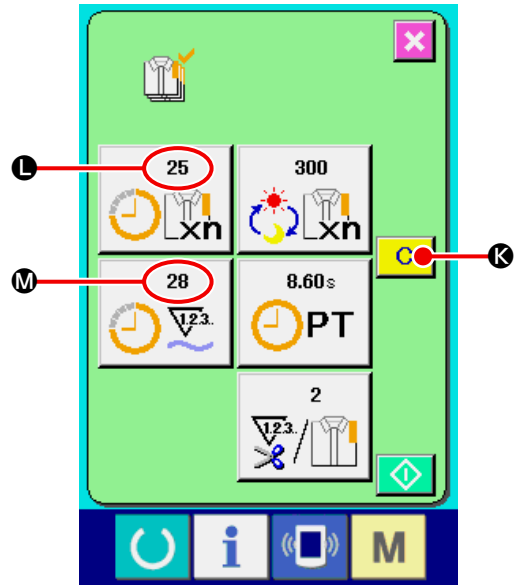

When CLEAR button **C** **N** is pressed in the clear confirmation screen, the counted value is cleared.

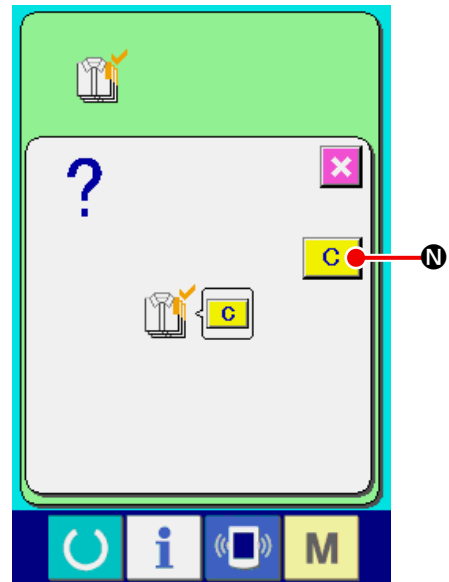

27-6 Observing the working measurement information

① Display the information screen.

When information key  **A** of the switch seat section is pressed in the data input screen, the information screen is displayed.

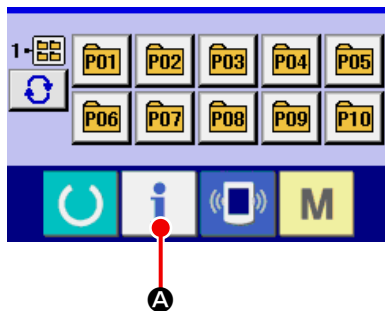

② Display the working measurement screen.

Press working measurement screen display button  **B** in the information screen. The working measurement screen is displayed.

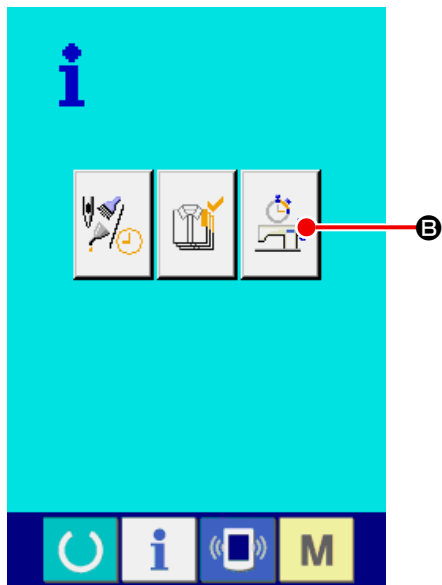

Information on the following 5 items is displayed in the working measurement screen.

- Ⓐ : This item automatically displays the machine working ratio from the time of starting the measurement.
- Ⓑ : This item automatically displays the machine speed from the time of starting the measurement.
- Ⓒ : This item automatically displays the pitch time from the time of starting the measurement.
- Ⓓ : This item automatically displays the machine time from the time of starting the measurement.
- Ⓔ : Number of times of thread trimming is displayed. Input the number of times referring to the next step ③ .

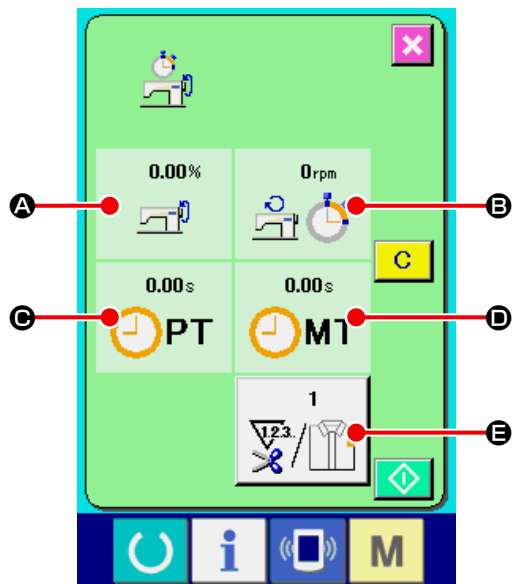

③ **The number of times of thread trimming.**

When number of times of thread trimming button



Ⓔ in the previous page is pressed, the number of times of thread trimming input screen is displayed.



Input the value you desire with TEN keys or +/- keys Ⓚ .

After the input, press ENTER button  Ⓣ .

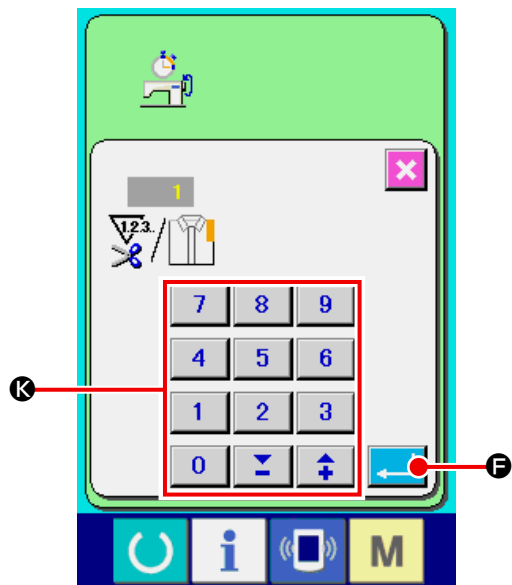
* When the input value is "0", count of the number of times of thread trimming is not performed. Use this function by connecting the external switch.





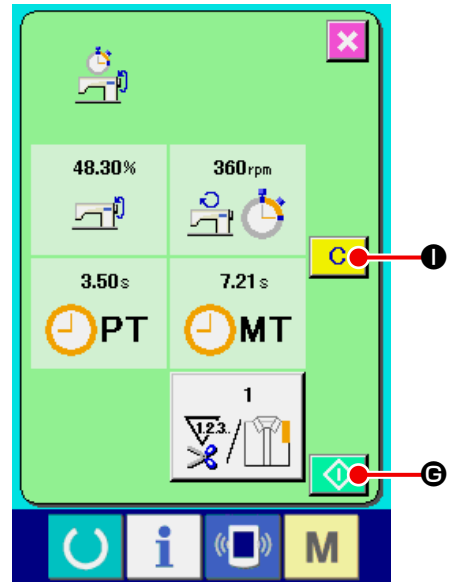

④ **Start measurement.**

When START button   is pressed, the measurement of each data is started.





⑤ **Stop count.**

Display the working measurement screen referring to steps ① and ② of **“27-6 Observing the working measurement information” p.104** .

When the measurement is being performed, STOP button   is displayed. When STOP button   is pressed, the measurement is stopped.

After the stop, START button is displayed at the position of STOP button. In case of continuing the measurement, press again START button.

The measured value is not cleared until CLEAR button is pressed   .

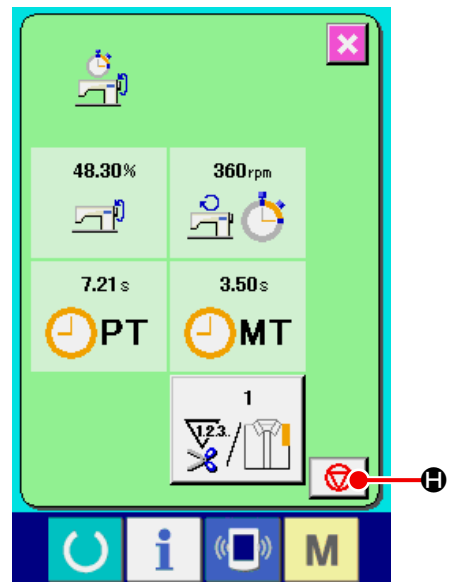



⑥ **Clear the counted value.**

When clearing the counted value, set the count to the stop state and press CLEAR button .

 **CLEAR button  is displayed only in case of stop state.**

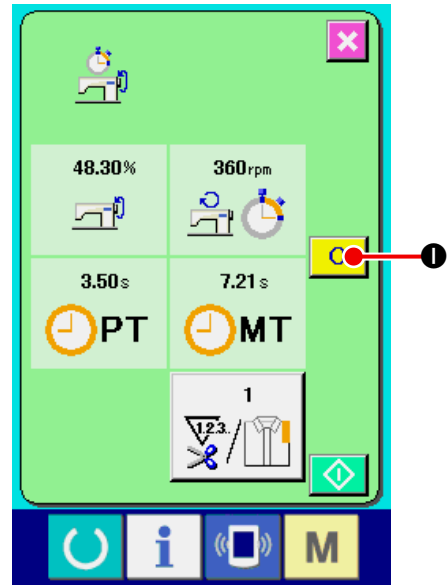
When CLEAR button  is pressed, the clear confirmation screen is displayed.



When CLEAR button  is pressed in the clear confirmation screen, the counted value is cleared.

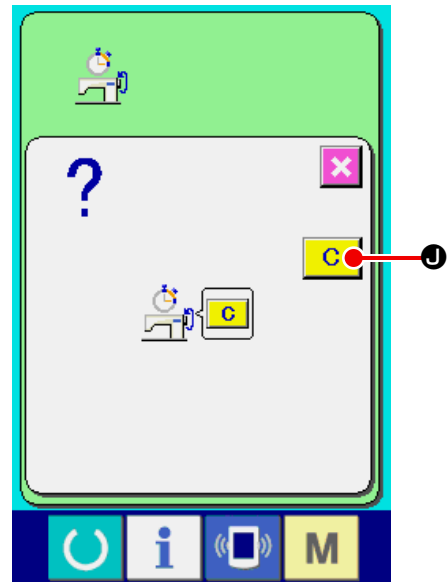

28. TRIAL SEWING FUNCTION

Data created with PM-1 (sewing data creation and edit software) can be sewn on trial by on-line connection of the personal computer with the sewing machine.

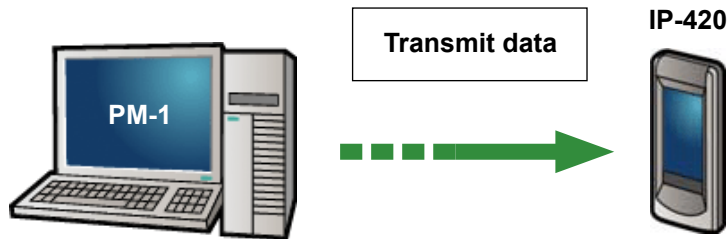

Connect the personal computer with IP-420 and transmit data to the sewing machine after creation of data with PM-1. When IP-420 becomes the data input screen, automatically the trial sewing screen is displayed. For the operating procedure of PM-1, see HELP of PM-1 or the like.

28-1 Performing trial sewing

① Receive the trial sewing data from PM-1.

When the trial sewing data (vector format data) is transmitted from PM-1, the screen on the right side is displayed, and the needle entry diagram of the transmitted data is displayed in the center of the screen. The display color of the needle entry diagram is different according to the thread tension value.

② Edit the vector parameter.

For the vector format data transmitted from PM-1, three items below can be set.

- Ⓐ : Thread tension
- Ⓑ : X scale rate or X actual size value
- Ⓒ : Y scale rate or Y actual size value

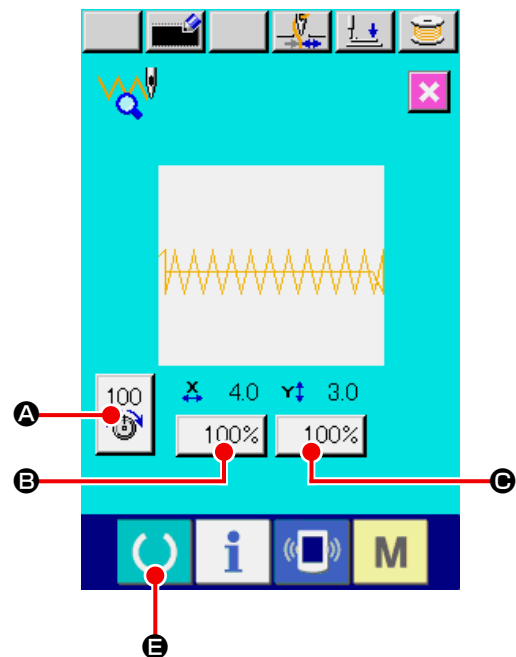

* To input the scale rate or to input the actual size value can be set with memory switch **U064** .

→ Refer to “**23. CHANGING MEMORY SWITCH DATA**” p.59 .

③ **Change the data.**

When the button of the item you desire to change from among buttons (A through C) is pressed, ten keys are displayed. Input the value you desire.

After inputting, press ENTER button  D .

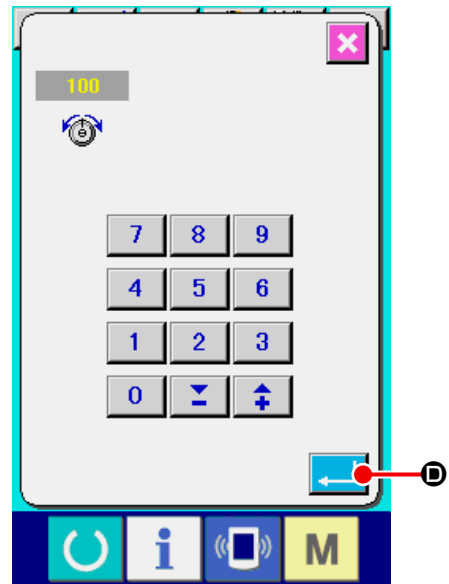
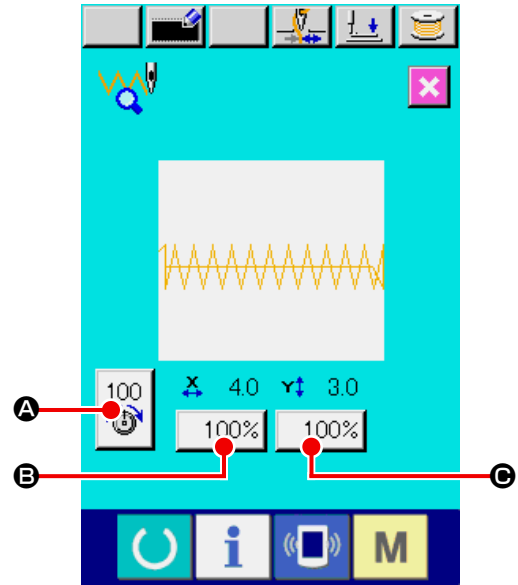

④ **Perform trial sewing.**

When READY key  E in the previous page is pressed, the trial sewing screen is displayed.

Trial sewing can be performed in this state.

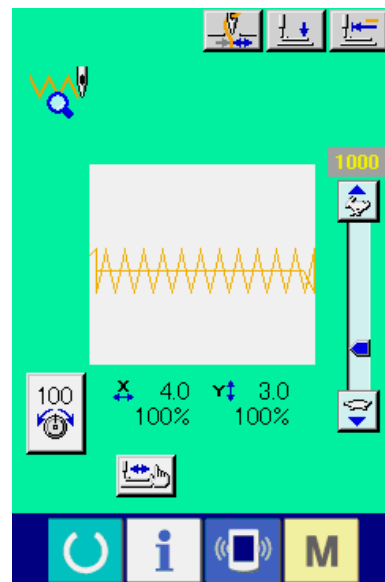

⑤ **Register the data to the users' pattern.**

When registering the data of trial sewing to the sewing machine, press REGISTER button 

F and the register screen is displayed. Input the users' pattern No. you desire to register with ten keys **G** .

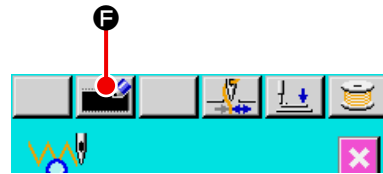

⑥ **Determine the register of data.**

When ENTER button  **H** is pressed, the register screen is closed and the register is finished.

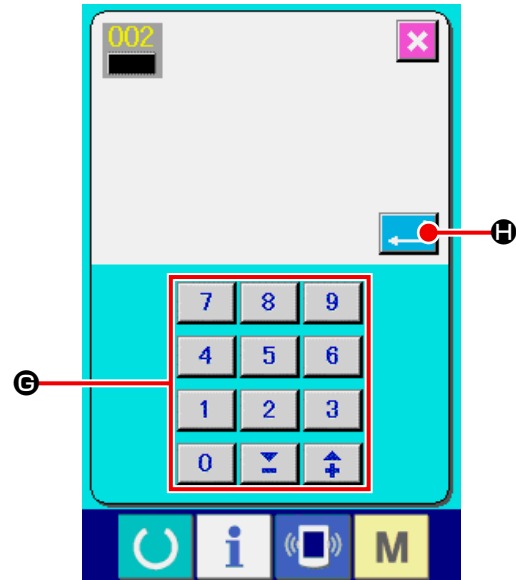

⑦ **Display the data input screen.**

After the register, the data input screen is automatically displayed.

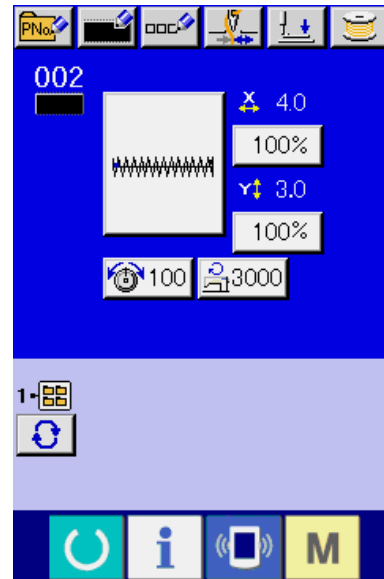

29. THREAD TENSION VALUE DISPLAY COLOR LIST

The display color of the needle entry diagram to be displayed varies according to the thread tension value which is set to the needle entry point. The color displayed according to the thread tension is as described below.

Thread tension value	Display color
0 to 20	 : Gray
21 to 40	 : Purple
41 to 60	 : Blue
61 to 80	 : Light blue
81 to 100	 : Green
101 to 120	 : Yellow green
121 to 140	 : Orange
141 to 160	 : Red
161 to 180	 : Pink
181 to 200	 : Black

30. SETTING APPROVAL/DISAPPROVAL OF CALLING OF PATTERN DATA

Calling of the wrong pattern by mistake is prevented by making the calling of the unnecessary pattern impossible. In addition, calling and using the necessary pattern can be performed.

① **Display the standard pattern selection screen.**

When **M** key is pressed, STANDARD PAT-

TERN SELECTION button  **A** is displayed.

When this button is pressed, the standard pattern selection screen is displayed.

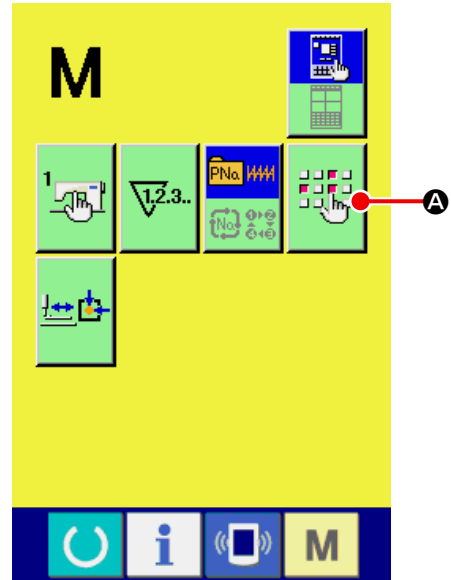

② **Setting approval/disapproval of calling**

The standard patterns which have been registered are displayed on the standard pattern selection screen. When UP/DOWN SCROLL button  **B** is pressed, the page is changed over.

Every time STANDARD PATTERN button  **C** is pressed, the normal state and the reverse state alternate with each other. In case of the normal state, reading is disapproved and in case of the reverse state, reading is approved.

However, in case of the standard pattern which has been already used, changeover from the reverse state to the normal state is not possible.

04
100
24.0
3.0
142

: Reading disapproved (normal state)

04
100
24.0
3.0
142

: Reading approved (reverse state)

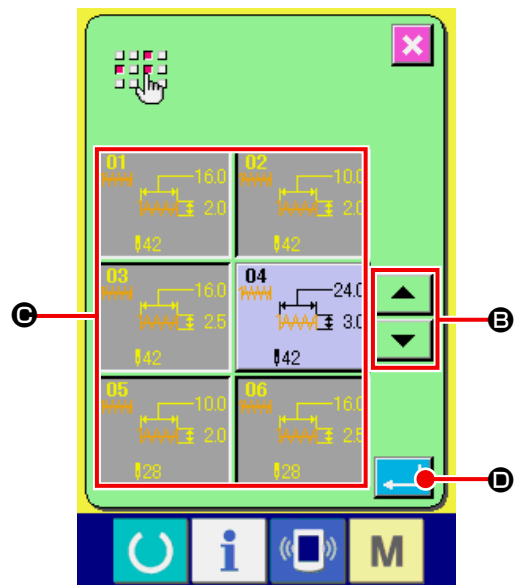

③ **Determining approval/disapproval of calling**

When ENTER button  **D** is pressed, setting of approval/disapproval is determined.

31. PERFORMING ADJUSTMENT OF ORIGIN OF PRESSER

① **Display the presser origin adjustment screen.**

When **M** key is pressed, PRESSER ORIGIN

ADJUSTMENT button  **A** is displayed.

When this button is pressed, the presser origin adjustment screen is displayed.

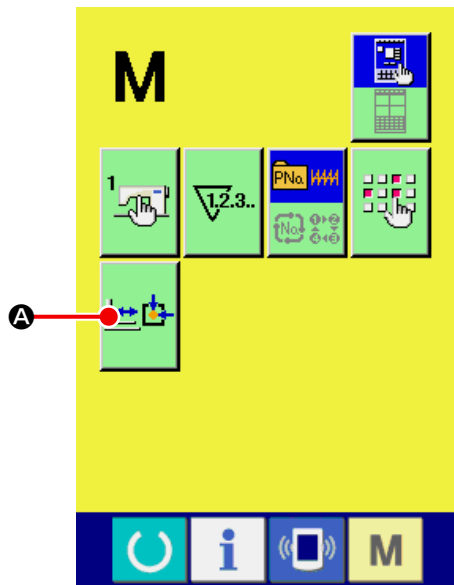

② **Perform the adjustment of the presser origin.**

Perform the origin retrieval with the start switch.

When CANCEL button  **B** is pressed, the presser origin adjustment screen is closed and the mode screen is displayed.

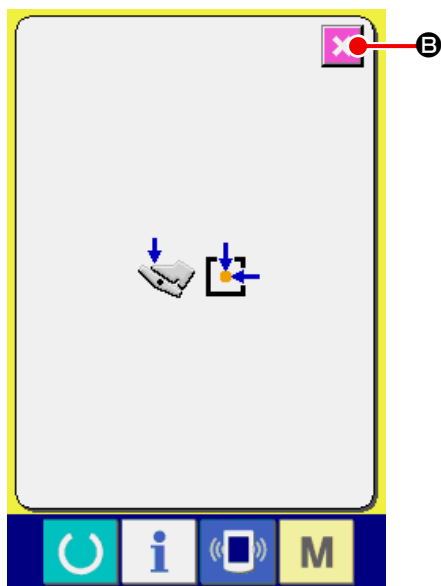

32. PERFORMING KEY LOCK

① Display the key lock screen.

In the state where the power is turned OFF, turn the power ON by turning ON the DIP switch 1-1 on the MAIN PCB.

When **M** key is held pressed for three seconds, KEY LOCK button  **A** is displayed on

the screen. When this button is pressed down, the key lock setting screen is displayed.

The existing setting status is displayed on the key lock button.





: Key lock non-setting status



: Key lock setting status

- * In the case the DIP switch 1-1 on the MAIN PCB is in the OFF state, the "key lock button" is not displayed on the mode screen.

② Select the key lock status and determine.

Select KEY LOCK STATUS button  **B** in the key lock setting screen, and press  **C**. Then the key lock setting screen is closed and the key lock status is obtained.

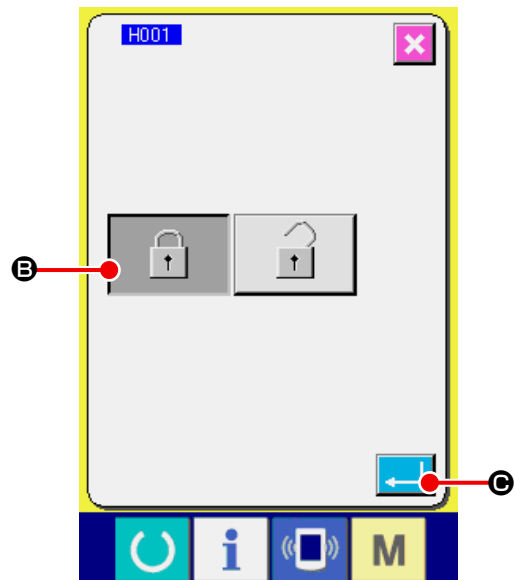
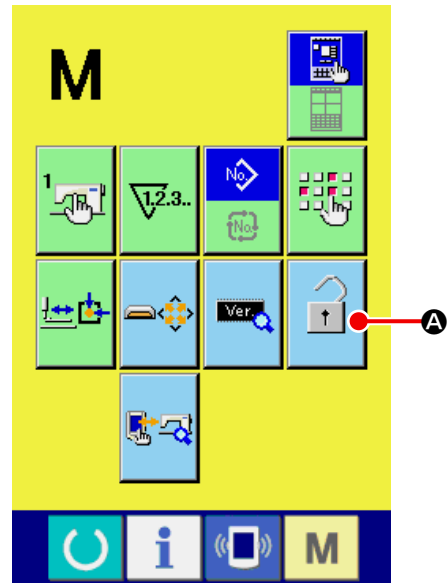

③ **Close the mode screen and display the data input screen.**

When the mode screen is closed and the data input screen is displayed, pictograph ㉓ showing the key lock status is displayed on the right side of the pattern No. display.

In addition, only the buttons which can be used even in the key lock status are displayed.

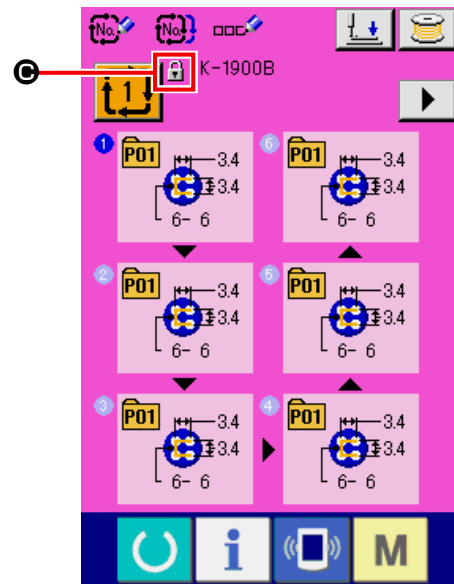
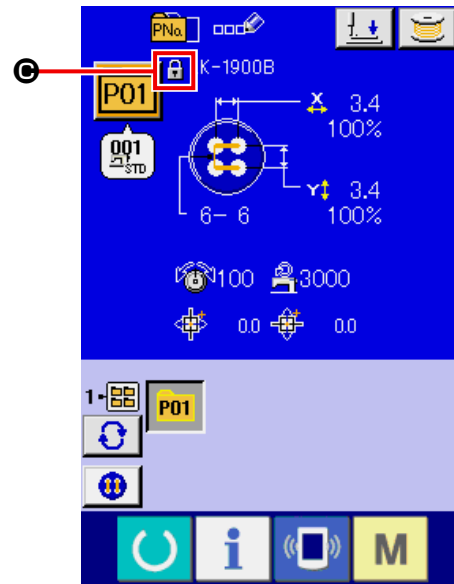

33. DISPLAYING VERSION INFORMATION

① Display the version information screen.

When **M** key is held pressed for three seconds,

VERSION INFORMATION button  **A**

is displayed on the screen. When this button is pressed, the version information screen is displayed.

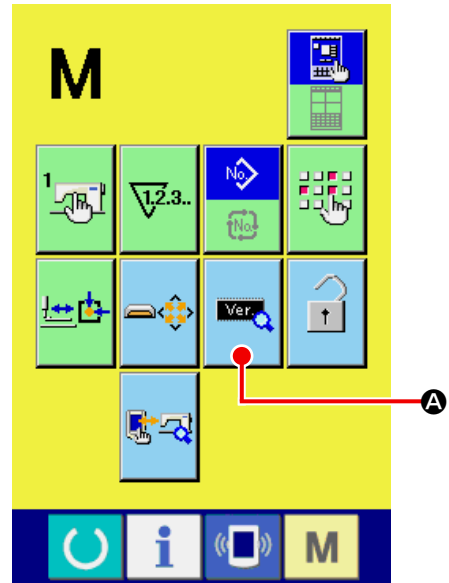

The version information on the sewing machine you use is displayed in the version information screen and it is possible to check.

- B** : Version information on panel program
- C** : Version information on main program
- D** : Version information on main shaft program

When CANCEL button  **E** is pressed, the version information screen is closed and the mode screen is displayed.

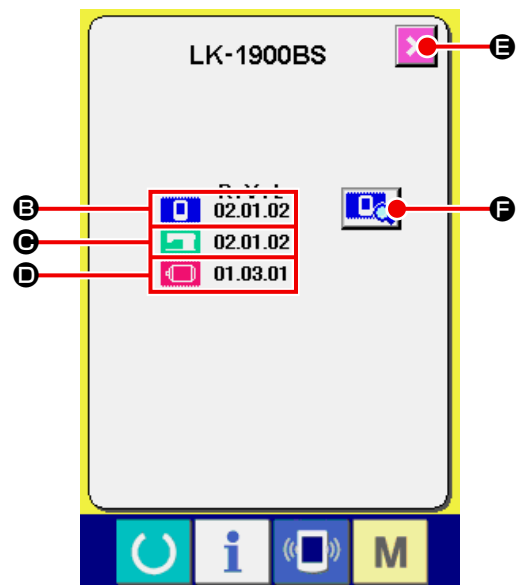

② Display the details display screen.

When DETAILS SCREEN DISPLAY button  **F** is pressed, the details screen of the panel program is displayed.

- G** : Module name
- H** : RVL
- I** : Check sum

When CANCEL button  **J** is pressed, the details display screen is closed and the version information screen is displayed.

When **M** key is pressed, the details display screen is closed and the data input screen which is being selected is displayed.

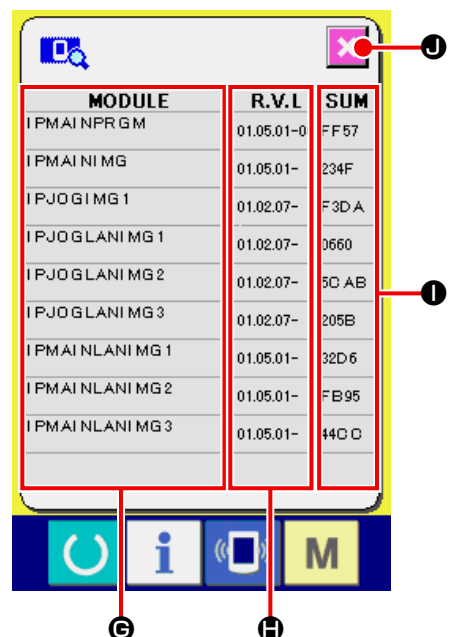

34. USING CHECK PROGRAM

34-1 To display the check program screen

When **M** key is held pressed for three seconds,

CHECK PROGRAM button  **A** is displayed on

the screen. When this button is pressed down, the check program screen is displayed.

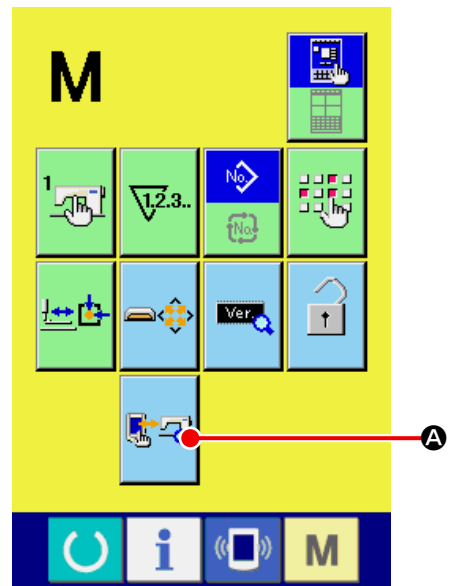

There are 9 items of the check programs below.

I001 Touch panel compensation screen

→ Refer to “**34-2 Performing compensation of touch panel**” p.119 .

I002 LCD check

→ Refer to “**34-3 Performing LCD check**” p.122 .

I003 Sensor check

→ Refer to “**34-4 Performing sensor check**” p.123 .

I004 Machine speed

→ Refer to “**34-5 Number of rotations of main motor check**” p.126 .

I005 Output check

→ Refer to “**34-6 Performing output check**” p.127 .

I006 Adjusting X/Y origins

→ Refer to “**34-7 Performing X/Y motors/origin sensors check**” p.129 .

I007 Adjusting presser and thread trimmer

→ Refer to “**34-8 Performing presser/thread trimmer motor/origin sensor check**” p.130 .

I008 Adjusting thread clamp

→ Refer to “**34-9 Performing thread clamp motor/origin sensor check**” p.131 .

I009 Continuous operation

→ Refer to “**34-10 How to carry out the continuous operation**” p.132 .

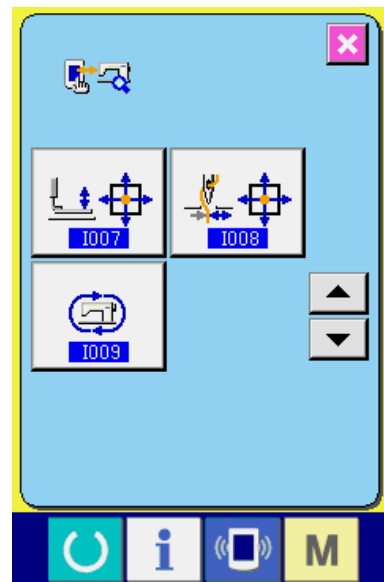
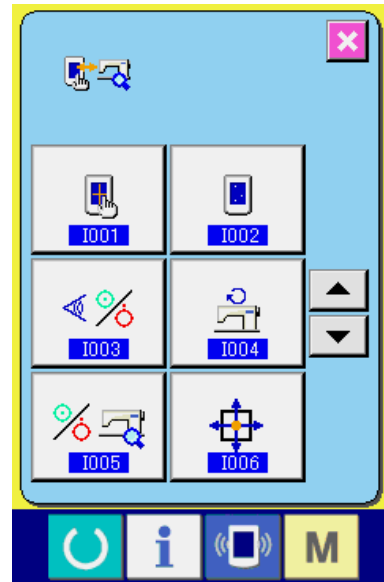

* For the LK-1903B/BR, the continuous operation is disabled.

34-2 Performing compensation of touch panel

① Display the touch panel compensation screen.

When TOUCH PANEL COMPENSATION button  **A** in the check program screen is pressed, the touch panel compensation screen is displayed.

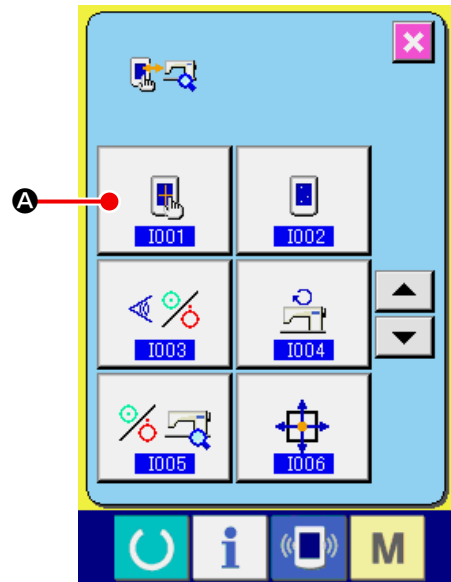

② Checking the correction on the touch panel correction confirmation screen

The touch panel correction confirmation screen is displayed.

Respectively press the correction marks (**D** , **E** , **F** and **G**) displayed on the four corners of the screen. Then, display **H** will change as described below.

Initial display :

(In the case the correction mark is not pressed)



The mark can be pressed :

(The touch panel has been properly corrected)



Mark is pressed :

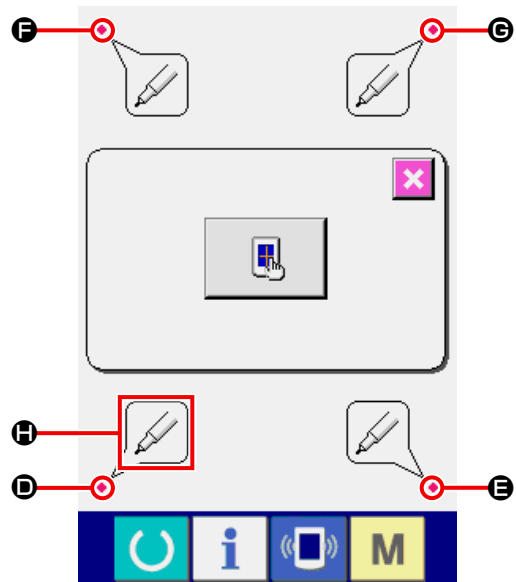

(The touch panel has not been properly corrected)



When pressing the correction mark, it is necessary to press it perpendicular to the touch panel.

③ Correcting the touch panel

After carrying out operation ② , carry out correction of the touch mark if "Out of mark" display  is shown.

When correcting the touch panel, press touch panel correction button  **I** to display the touch panel correction screen. If it is not necessary to correct the touch panel, press cancel button  **J** to return to the check program screen.

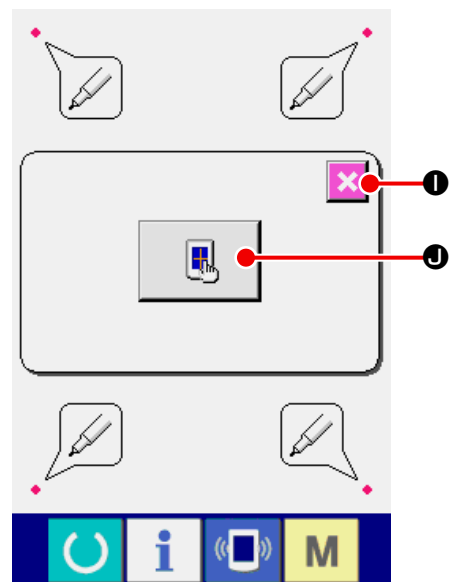



④ **Press the lower position on the left side.**

Press red circle  **D** located on the lower left side in the screen.

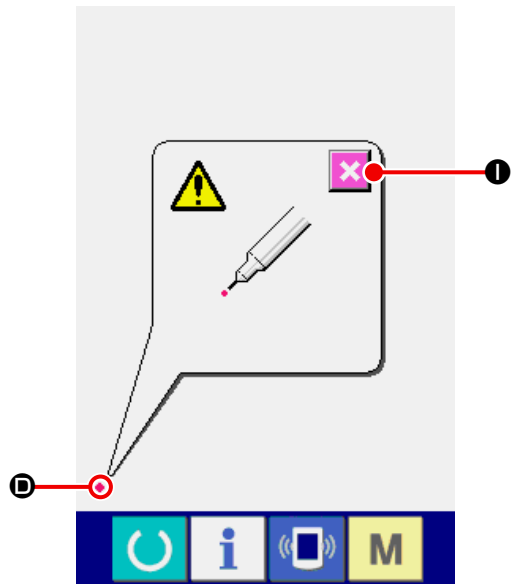
When ending the compensation, press CANCEL button  **I**.



⑤ **Press the lower position on the right side.**

Press red circle  **E** located on the lower right side in the screen. When ending the compensation, press CANCEL button  **I**.

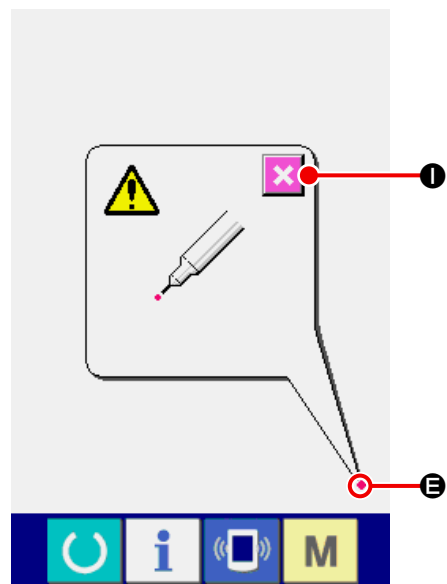

⑥ **Press the upper position on the left side.**

Press red circle  **F** located on the upper left side in the screen.

When ending the compensation, press CANCEL button  **I**.

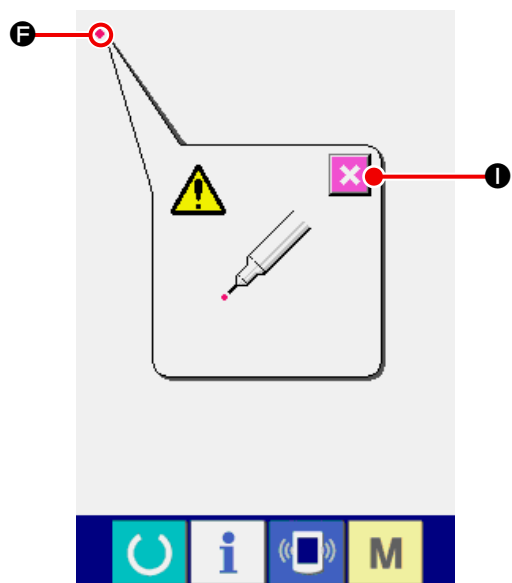

⑦ **Press the upper position on the right side.**

Press red circle ● **G** located on the upper right side in the screen.

When ending the compensation, press CANCEL button **X** **I**.

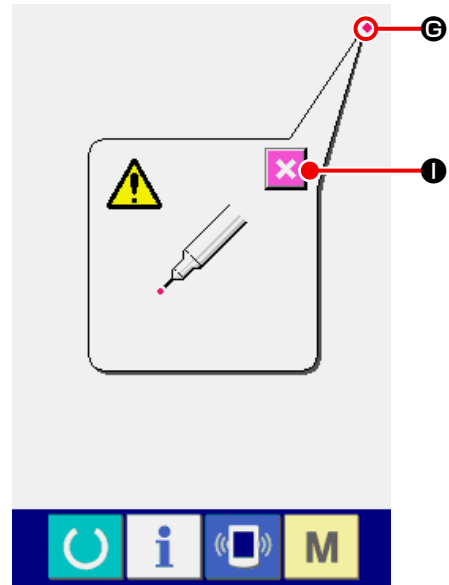

⑧ **Store data**

When the four points have been pressed, the compensation data are stored, and the screen showing power OFF **K** forbidden is displayed.

Do not turn OFF the power while this screen **K** is displayed.

When the power is turned OFF, the compensated data are not stored.

When storing ends, the check program screen is automatically displayed.

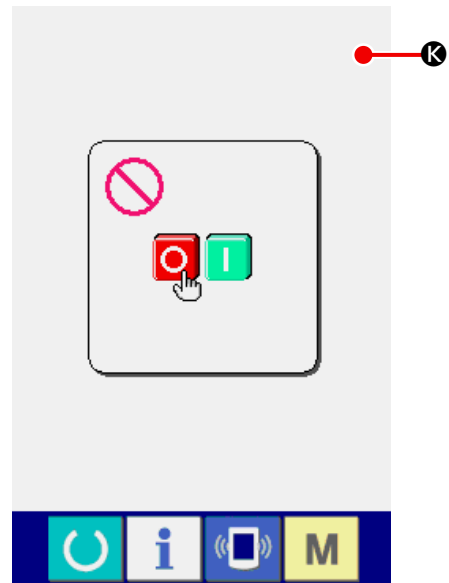

34-3 Performing LCD check

① **Display the LCD check screen.**

When LCD CHECK button  **A** in the check program screen, the LCD check screen is displayed.

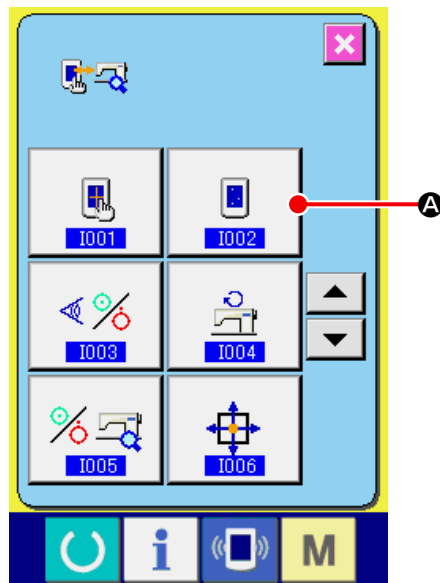

② **Check whether there is any dot-omission of LCD.**

For the LCD check screen, the screen is displayed with one color only. Perform checking of LCD.

When checking has ended, press a suitable place in the screen. The LCD check screen is closed and the check program screen is displayed.



34-4 Performing sensor check

① Display the sensor check screen.

When SENSOR CHECK button  **A** in the check program screen is pressed, the sensor check screen is displayed.

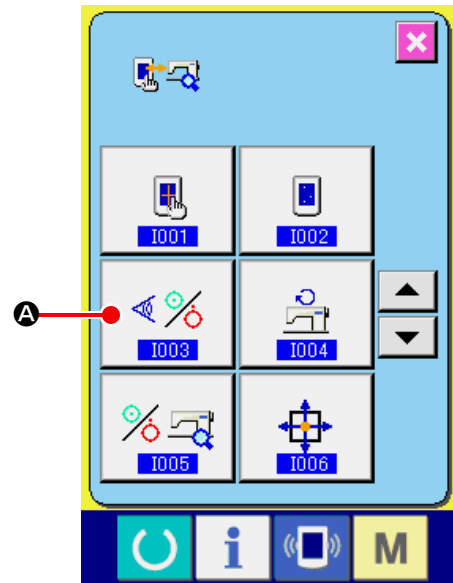



② Performing sensor check.

Input status of various sensors can be checked in the sensor check screen.

Input status of each sensor is shown as **B**.

The display of ON status/OFF status is as shown below.

 : ON status



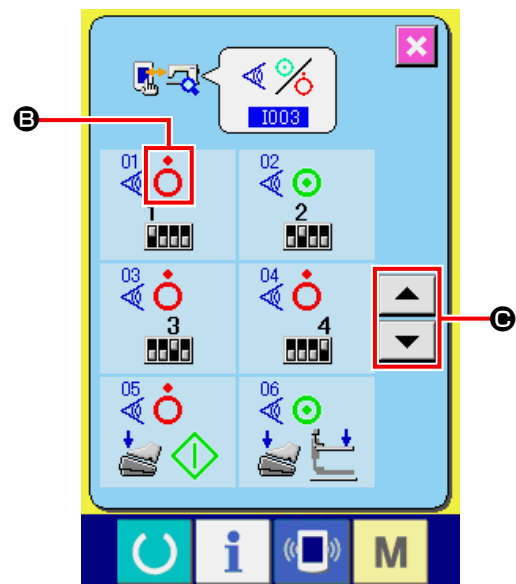









 : OFF status

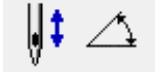

Press UP/DOWN SCROLL button  **C** and display the sensor information you desire to confirm.

21 kinds of the sensors below are displayed.

No.	Pictograph	Description of sensor
01		DIPSW2-1
02		DIPSW2-2
03		DIPSW2-3
04		DIPSW2-4
05		Optional start SW
06		Optional presser SW
07		Optional presser 2 SW
08		Pedal SW (Pedal input value is displayed.)
09		Needle upper dead point (5 to 30°)
10		Needle lower dead point (185 to 215°)
11		Needle lower position (80 to 123°)
12		Needle UP position (40 to 62°)
13		TG (45 times/rotation)
14		Feed reference (125 to 155°)

No.	Pictograph	Description of sensor
		Main motor Z phase (0 to 180°)
		Head tilt SW
		Temporary stop switch
		Thread breakage detection switch
		Angle of the needle bar of the sewing machine (0 to 359)
		Suction nozzle
		Shorter-thread remaining type thread trimmer cylinder switch



34-5 Number of rotations of main motor check

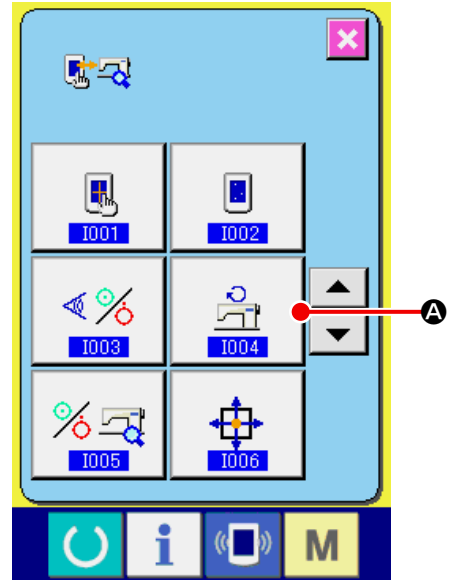

① **Display the number of rotations of main motor check screen.**

When NUMBER OF ROTATIONS OF MAIN MOTOR CHECK button  (A) in the check program screen is pressed, the number of rotations of main motor check screen is displayed.



② **Rotate main motor and perform checking the observed value.**

Number of rotations can be set with +/- buttons   (B and C).

When READY key  (D) is pressed, the sewing machine can be rotated with the number of rotations which has been set. At this time, the number of rotations which has been observed is displayed at  (E).

When RESET button  (F) is pressed, the sewing machine stops.

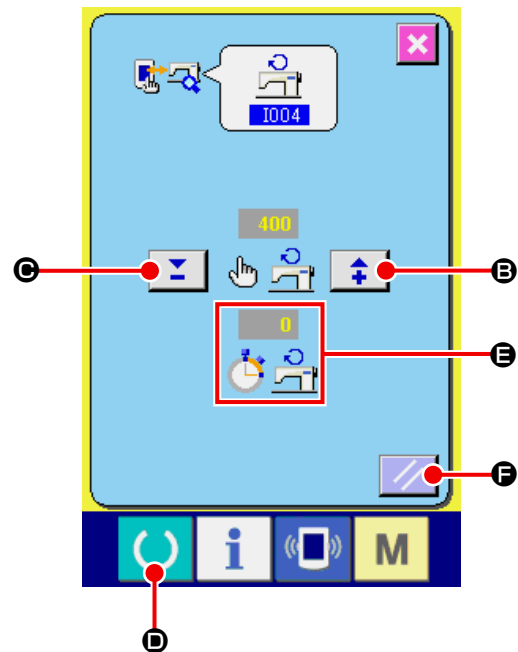

34-6 Performing output check

① Display the output check screen.

When OUTPUT CHECK button  **A** in the check program screen is pressed, the output check screen is displayed.

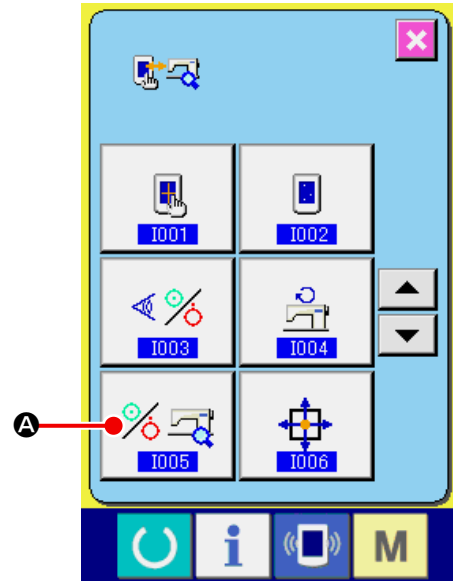









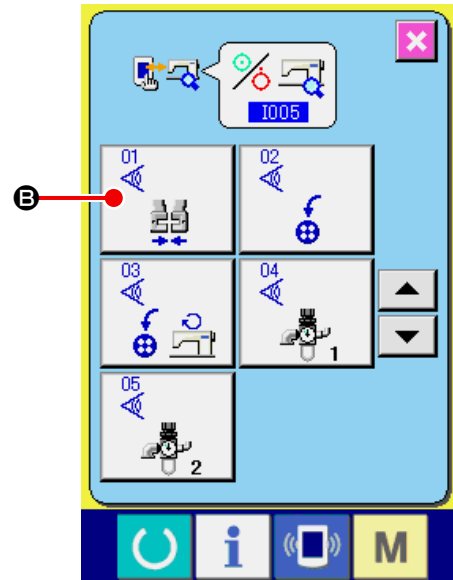





② Perform output check.

Output check such as "1901 Material fitting magnet".

Press OUTPUT CHECK button  **B** .

Cloth open magnet ON is output while the button is held pressed.



No.	Pictograph	Description of input
		1901 material fitting
		Operation for BR35 is enabled
		Operation for BR35 of during sewing.
		Air output 1
		Air output 2
		Spare solenoid valve
		Thread waste suction

34-7 Performing X/Y motors/origin sensors check

① **Display the X/Y motors/origin sensors check screen.**

When X/Y MOTORS/ORIGIN SENSORS CHECK

button  **A** in the check program screen is pressed, the X/Y motors/origin sensors check screen is displayed.

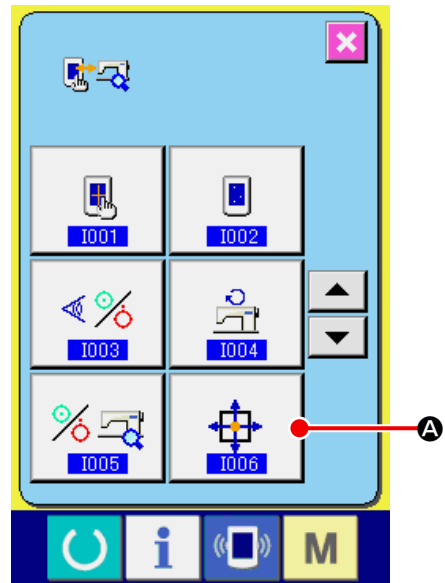

② **Perform X/Y motors/origin sensors check.**

Information on the positions of the X- and Y-motors is displayed on **B**.

Press ARROW MARK buttons  **C** and X/Y motors are driven by 0.1 mm at a time in the +/- direction.

 **Motors which have not been selected are driven as well in order to interpolate the arc.**

Perform the origin retrieval of X/Y motors to both shafts with the start switch.

The current position is brought to the XY origin by keeping DETERMINE TO ORIGIN button  **D** held pressed for two seconds.

The information on the X/Y positions will be set to zero (0).

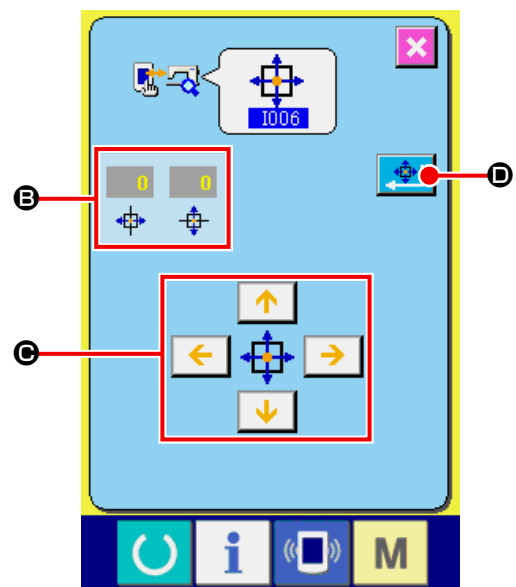

34-8 Performing presser/thread trimmer motor/origin sensor check

- ① **Display the presser/thread trimmer motor/origin sensor check screen.**

When PRESSER/THREAD TRIMMER MOTOR/ORIGIN SENSOR CHECK button  (A) in the check program screen is pressed, the presser/thread trimmer/origin sensor check screen is displayed.

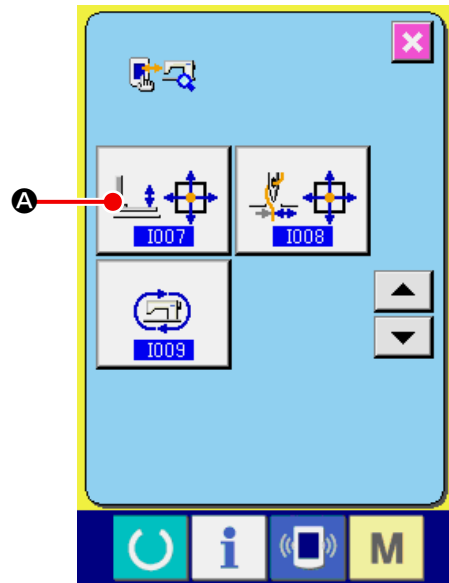



- ② **Perform presser/thread trimmer/origin sensor check.**

Perform the origin retrieval of presser/thread trimmer motor with the start switch.

ON/OFF status of the thread trimmer sensor is displayed at the position of (B) according to the status of the thread trimmer sensor.

ON/OFF status of presser origin sensor is displayed at the position of (C) according to the status of presser origin sensor.

Presser/thread trimmer motor is driven by one pulse at a time with + and - buttons  (E and D).

In addition, when NORMAL POSITION TRAVEL button  (F) is pressed, the presser/thread trimmer motor is driven to the normal positions below, and the pictograph showing the position is displayed in gray.

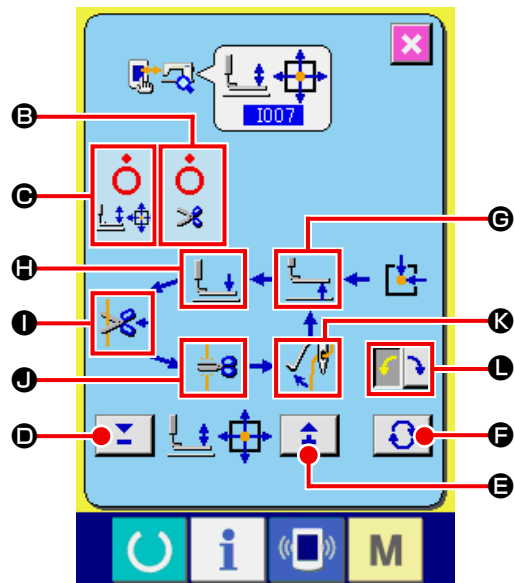

- (B) : Presser UP position
- (H) : Presser DOWN position (DOWN position at the time of pedal operation)
- (I) : Thread trimmer position
- (J) : Presser DOWN position (DOWN position after thread trimming)
- (K) : Wiper sweeping position

When REVERSE ROTATION button  (L) is pressed, the motor is driven in reverse rotation.



The positions above are effective after performing the origin retrieval of presser/thread trimmer motor with the start switch.

34-9 Performing thread clamp motor/origin sensor check

① **Display the thread clamp motor/origin sensor check screen.**

When THREAD CLAMP MOTOR/ORIGIN SENSOR CHECK button  **A** in the check program screen is pressed, the thread clamp motor/origin sensor check screen is displayed.

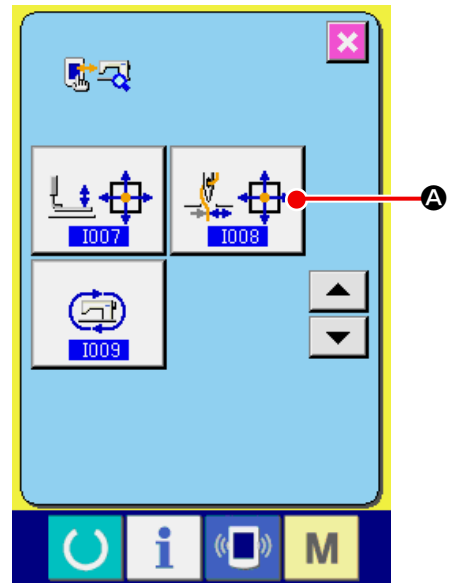

② **Perform thread clamp motor/origin sensor check.**

Perform the origin retrieval of the thread clamp motor with the start switch.

Information on the position of the thread clamp encoder is displayed on **E**.

Thread clamp motor is driven by one pulse at a time with + and - buttons  (**C** and **D**).

In addition, when NORMAL POSITION TRAVEL button  **I** is pressed, thread clamp motor is driven to the normal positions below and the pictograph showing the position changes the color.

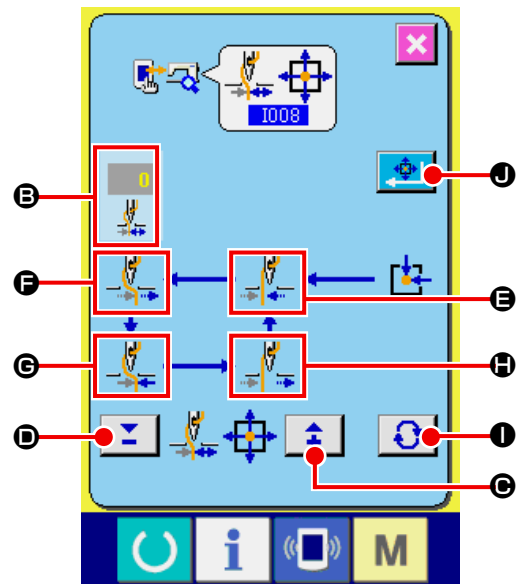

- E** : Waiting position (front)
- F** : Thread bend position
- G** : Thread clamp position
- H** : Retracted position (rear side)

 **The positions above are effective after performing origin retrieval of thread clamp motor with the start switch.**

The current position is set as the thread clamp origin by keeping DETERMINE TO ORIGIN button  **J** held pressed for two seconds. Once the origin position setting is completed, "27" will be displayed.

34-10 How to carry out the continuous operation

① Displaying the continuous operation setting screen

Press continuous operation button  **A** on the check program screen to display the continuous operation setting screen.

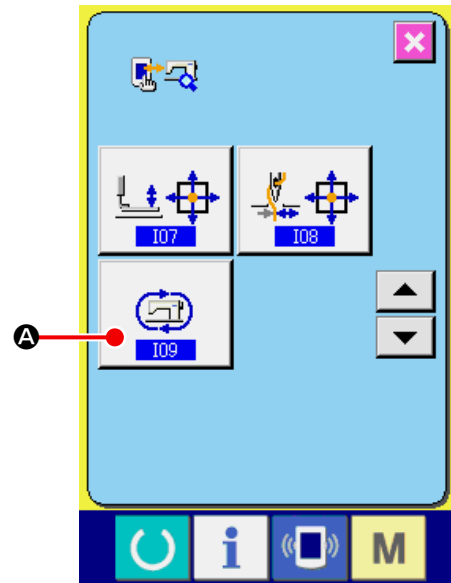

② Setting the continuous operation mode

Carry out the continuous operation mode setting on the continuous operation setting screen.

B : Operation interval (rest time)

C : Retrieval of origin of the sewing end

0 : None

1 : Once every 100 times

2 : Every time

The continuous operation setting is determined by pressing enter button  **D** . At this time, the sewing machine is set in the continuous operation mode.

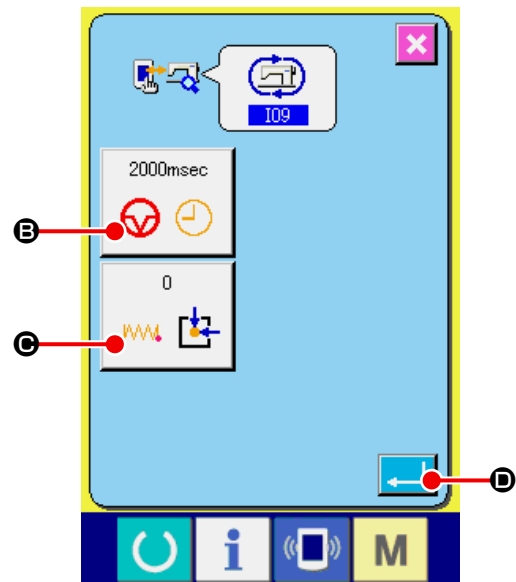

③ Carrying out the continuous operation

Turn ON set-ready key  **E** to display the sewing screen. In this state, the sewing machine starts the continuous operation. When the pause switch is pressed, the sewing machine stops the continuous operation. Once the sewing machine re-performs sewing, it starts the continuous operation.

To reset the continuous operation mode, turn the power OFF once and re-turn ON the power to the sewing machine.

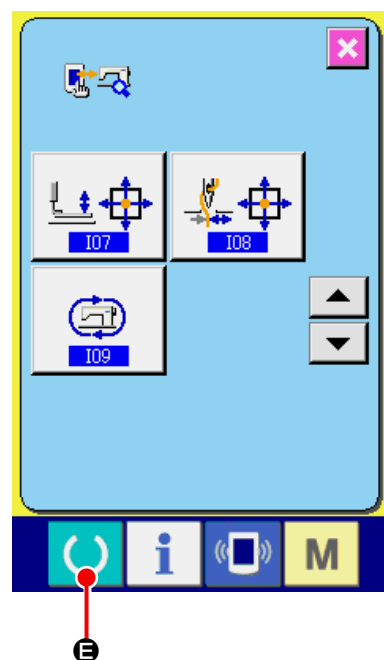





35. COMMUNICATION SCREEN OF MAINTENANCE PERSONNEL LEVEL

For the communication screen, the level which is normally used and the one which is used by the maintenance personnel are different in the kinds of data to be handled.

35-1 Data which are possible to be handled

In case of the maintenance personnel level, it is possible to use 5 different kinds of data in addition to the normal two kinds.

The respective data formats are as below.

Data name		Extension	Description of data
Adjustment data		Model name+00XXX.MSW Example) LK00001.MSW	Data of memory switches 1 and 2
All sewing machine data		Model name+00XXX.MSP Example) LK00001.MSP	All data which are held by sewing machine
Panel program data		BP+RVL(6 digits).HED BP+RVL(6 digits).PXX BM+RVL(6 digits).IXX	Program data and display data of panel
Main program data		MA+RVL(6 digits).PRG	Program data of main
Servo program data		MT+RVL(6 digits).PRG	Program data of servo

xxx : File No.

35-2 Displaying maintenance personnel level

- ① **Display the communication screen of the maintenance personnel level.**

When key  **A** is pressed as long as three seconds, the image located at the upper left position is changed to orange color **B** and the communication screen of the maintenance personnel level is displayed.

For the operating procedure, refer to **“26-4 Performing communication” p.88** .

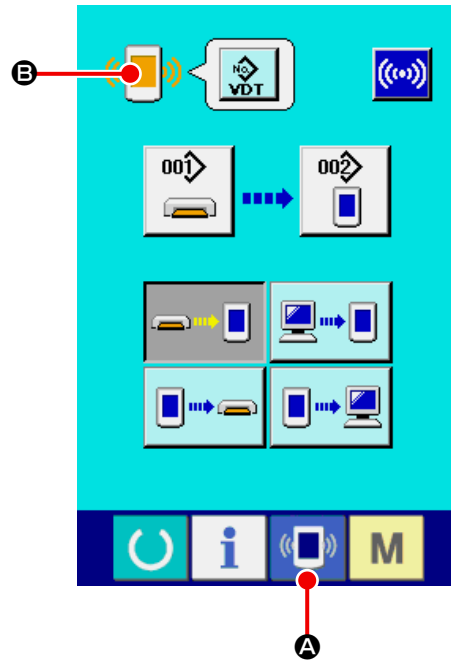

- * When the adjustment data or the all sewing machine data is selected, the display becomes as shown on the right-hand side and it is not necessary to specify No. on the panel side.

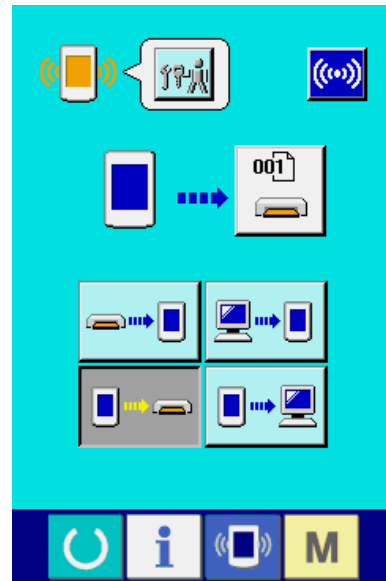

35-3 Performing rewriting of program

① **Select the kind of data.**

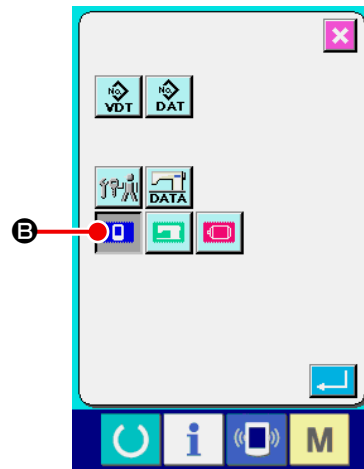
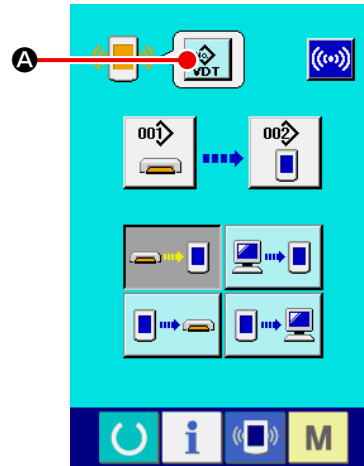

When DATA KIND button  **A** in the communication screen of the maintenance personnel level, the data selection screen is displayed.

Select PANEL PROGRAM DATA  **B**.



② **Select the file.**

When FILE SELECTION button  **C** is pressed in the communication screen, the file selection screen is displayed.

Press FILE RETRIEVAL button  **D**, select DOWNLOAD PROGRAM  **E** and press ENTER button  **F**.

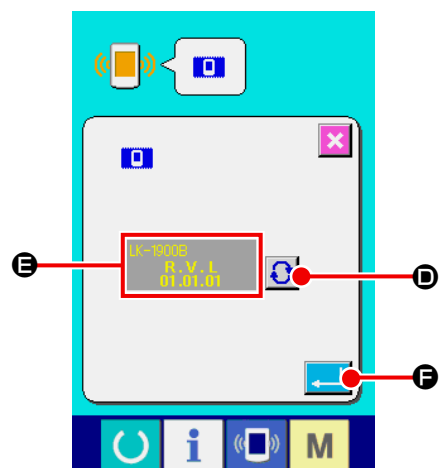
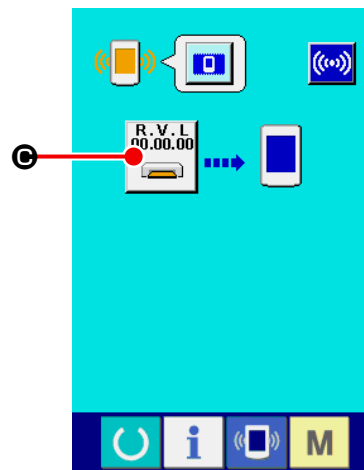

③ **Start rewriting of the program.**

When COMMUNICATION START button  is pressed, rewriting of the program is started.

 **Do not perform cut-off of the power and closing/opening of the media cover during working. The main unit may be broken down.**

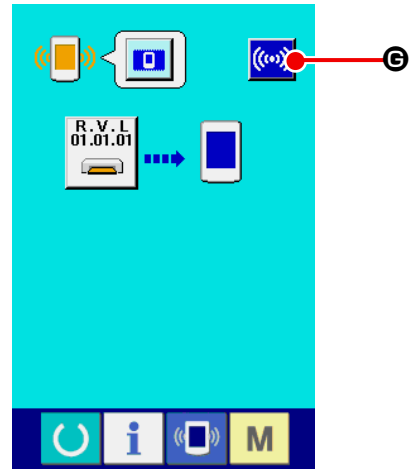

During data erasing screen

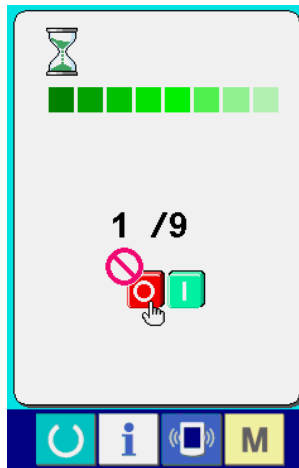

During data writing screen

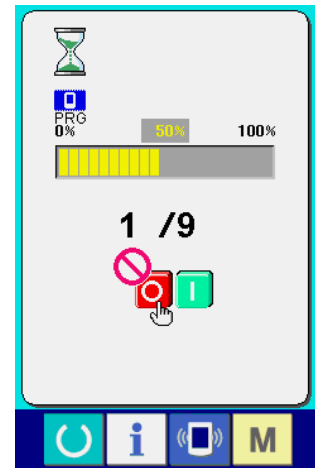

End screen

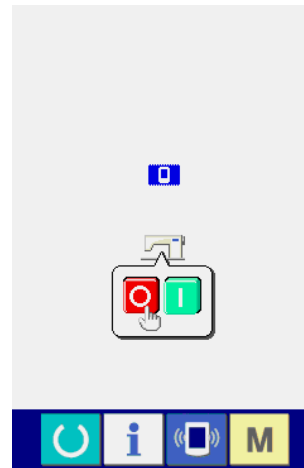

When the end screen is displayed, changing of the application ends.

If the data writing abnormality screen is displayed, quickly turn OFF the power and perform setup again after confirming [Confirmation items] below.

[Confirmation items]

- 1) Media cover is opened during data communication from the media.
- 2) Data of the media is not correct.
- 3) Contact part of the media is dirty. Defective contact

Data writing abnormality screen

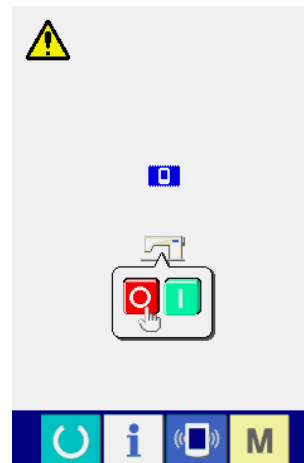

36. INFORMATION SCREEN OF THE MAINTENANCE PERSONNEL LEVEL

36-1 Display of error record

- ① **Display the information screen of the maintenance personnel level.**

When INFORMATION key  **A** of switch seat section is pressed for approximately three seconds in the data input screen, the information screen of the maintenance personnel level is displayed. In case of the maintenance personnel level, the pictograph located at the upper left position changes from blue color to orange color, and 5 buttons are displayed.

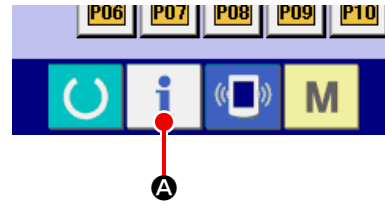

- ② **Display the error record screen.**

Press ERROR RECORD SCREEN DISPLAY button  **B** in the information screen. The error record screen is displayed.

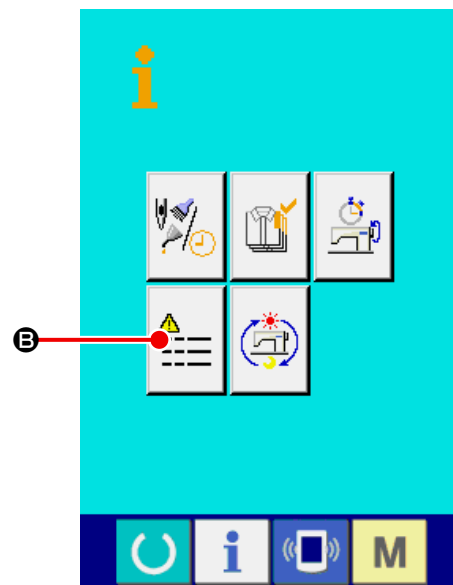

Error record of the sewing machine you use is displayed in the error record screen, and you can check the error.

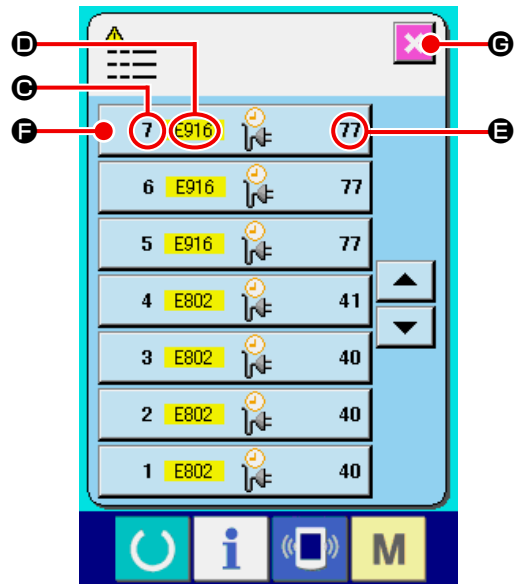

- Ⓒ : Order that error has occurred.
- Ⓓ : Error code
- Ⓔ : Cumulative current-carrying time (hour) at the time of occurrence of error

When CANCEL button  Ⓒ is pressed, the error record screen is closed and the information screen is displayed.



③ Display the details of error.

When you desire to know the details of error, press ERROR button  Ⓕ you desire to know. The error detail screen is displayed.

Pictograph  and description of error  corresponding to the error code are displayed in the details of error screen.

→ Refer to “24. ERROR CODE LIST” p.72 .

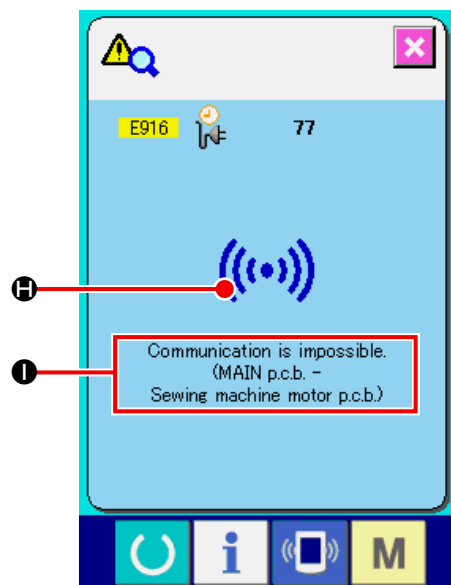

36-2 Display of the cumulative working information

① Display the information screen of the maintenance personnel level.

When INFORMATION key  of switch seat section is pressed for approximately three seconds in the data input screen, the information screen of the maintenance personnel level is displayed. In case of the maintenance personnel level, the pictograph located at the upper left position changes from blue color to orange color, and 5 buttons are displayed.

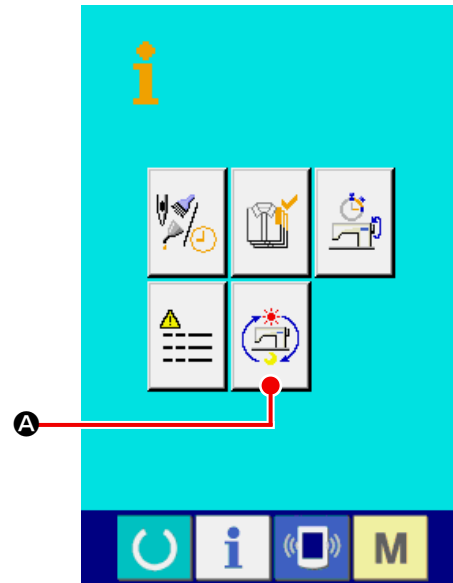

② Display the cumulative working information screen.

Press CUMULATIVE WORKING INFORMATION SCREEN DISPLAY button  **A** of the information screen. The cumulative working information screen is displayed.

Information on the following 4 items are displayed in the cumulative working information screen.

- B** : Cumulative working time (hour) of the sewing machine is displayed.
- C** : Number of cumulative times of thread trimming is displayed.
- D** : Cumulative current-carrying time (hour) of the sewing machine is displayed.
- E** : Number of cumulative stitches is displayed.
(Unit : ×1,000 stitches)

When CANCEL button  **F** is pressed, the cumulative working information screen is closed and the information screen is displayed.

