

PARTS LIST

LH-3500A Series PARTS LIST

下記 URL より、便利な検索機能のついた Web Parts List をご利用頂けます。

ご利用には会員登録が必要です。(無料)

<https://www.juki.co.jp/partslist/>

You can use a Web Parts List with a convenient search function from the URL below. To use this website, free membership registration is required.

<https://www.juki.co.jp/partslist/>

HOW TO MAKE USE OF THIS PARTS LIST

1.Explanation of codes

1)"*" mark.....means this part is changed from the previous parts book.

As to the details of the change, refer to "List for information of change".

2)"#01".....refer to "Note" explanation at bottom of page.

2.Codes on the "Qty" column

• Each numeral indicates the number of parts required.

• "0.1" and "2.5" indicate the length (in meters) of the respective parts.

3.Parentheses mean that the corresponding part is a subpart that constructs an assembly part.

4.Dotted lines on the Figures indicate assembly parts.

5.As to the parts with marks of "☆" (consumable parts) and "◎" (optional parts) on the respective parts, it is recommended to prepare spares.

パーツリストご利用に際して

1. "注記" 欄の記号説明

1) "*" 印 前回のパーツブックに比較して今回変更された部品を意味します。

変更内容は "変更情報リスト" を参照してください。

2) "#01" ページ下の "注記" の説明を参照してください。

2. 数量欄の数字は、個数を表し、0.1、2.5 等の数値は、長さ (単位メートル) を表します。

3. 数量欄の () は、組部品を構成している子部品であることを意味します。

4. イラストページの-----枠は、組構成であることを意味します。

5. リストページの "☆" (消耗部品)、"◎" (オプション部品) の印がついた部品は、予備を準備しておくことをお奨めします。

CONTENTS

目次

1. FRAME & MISCELLANEOUS COVER COMPONENTS	1
頭部・外装関係	
2. MAIN SHAFT & THREAD TAKE-UP COMPONENTS	3
上軸・天秤関係	
3. NEEDLE BAR COMPONENTS (1)(FOR LH-3528A,LH-3528A-7,3578A,3578A-7).....	5
針棒関係 (1) (LH-3528A,3528A-7,3578A,3578A-7 用)	
4. NEEDLE BAR COMPONENTS (2)(FOR LH-3568A,LH-3568A-7,3588A,3588A-7).....	7
針棒関係 (2) (LH-3568A,3568A-7,3588A,3588A-7 用)	
5. TENSION POST COMPONENTS (1)(LH-3528A,3528A-7 TYPE S/G)(LH-3578A,3578A-7 TYPE G).....	9
糸調子関係 (1) (LH-3528A,3528A-7 S/G 仕様) (LH-3578A,3578A-7 G 仕様)	
6. TENSION POST COMPONENTS (2)(LH-3528A TYPE A/F).....	11
糸調子関係 (2) (LH-3528A A/F 仕様)	
7. TENSION POST COMPONENTS (3)(LH-3568A,3568A-7 TYPE S/G)(LH-3588A,3588A-7 TYPE G).....	13
糸調子関係 (3) (LH-3568A,3568A-7 S/G 仕様) (LH-3588A,3588A-7 G 仕様)	
8. HOOK & HOOK DRIVING SHAFT COMPONENTS (1).....	15
釜・下軸関係 (1)	
9. HOOK & HOOK DRIVING SHAFT COMPONENTS (1)(FOR LH-3578A,3578A-7,3588A,3588A-7).....	17
釜・下軸関係 (2) (LH-3578A,3578A-7,3588A,3588A-7 用)	
10. HOOK & HOOK DRIVING SHAFT COMPONENTS (3).....	19
釜・下軸関係 (3)	
11. FEED MECHANISM COMPONENTS.....	21
送り関係	
12. PRESSER BAR & TENSION RELEASE COMPONENTS.....	23
押さえ棒・糸ゆるめ関係	
13. THREAD TRIMMER MECHANISM COMPONENTS (FOR LH-3528A-7,3568A-7,3578A-7,3588A-7).....	25
糸切り装置関係 (LH-3528A-7,3568A-7,3578A-7,3588A-7 用)	
14. AUTOMATIC REVERSE FEED MECHANISM COMPONENTS.....	27
自動逆送り関係	
15. WIPER MECHANISM COMPONENTS (FOR LH-3528A-7,3568A-7,3578A-7,3588A-7).....	29
ワイパー装置関係 (LH-3528A-7,3568A-7,3578A-7,3588A-7 用)	
16. LUBRICATION COMPONENTS (FOR LH-3528A,3528A-7,3568A,3568A-7).....	31
給油関係 (LH-3528A,3528A-7,3568A,3568A-7 用)	
17. LUBRICATION COMPONENTS (FOR LH-3578A,3578A-7,3588A,3588A-7).....	33
給油関係 (FOR LH-3578A,3578A-7,3588A,3588A-7 用)	
18. BELT COVER & BOBBIN WINDER COMPONENTS	35
ベルトカバー・糸巻き装置関係	
19. BOTTOM COVER COMPONENTS	37
ボトムカバー関係	
20. AK DEVICE COMPONENTS	38
A K 装置関係	

21. THREAD STAND COMPONENTS.....	39
糸立装置関係	
22. ACCESSORIE PARTS COMPONENTS.....	41
付属品関係	
23. TABLE OF EXCHANGING GAUGE PARTS (1)(FOR LH-3528A).....	43
交換ゲージ部品一覧表（1）（LH-3528A用）	
24. TABLE OF EXCHANGING GAUGE PARTS (2)(FOR LH-3528A).....	45
交換ゲージ部品一覧表（2）（LH-3528A用）	
25. TABLE OF EXCHANGING GAUGE PARTS (FOR LH-3528A-7).....	47
交換ゲージ部品一覧表（LH-3528A-7用）	
26. TABLE OF EXCHANGING GAUGE PARTS (FOR LH-3568A).....	49
交換ゲージ部品一覧表（LH-3568A用）	
27. TABLE OF EXCHANGING GAUGE PARTS (FOR LH-3568A-7).....	51
交換ゲージ部品一覧表（LH-3568A-7用）	
28. TABLE OF EXCHANGING GAUGE PARTS (LH-3578A TYPE G).....	53
交換ゲージ部品一覧表（LH-3578A G仕様）	
29. TABLE OF EXCHANGING GAUGE PARTS (LH-3588A TYPE G).....	55
交換ゲージ部品一覧表（LH-3588A G仕様）	
30. TABLE OF EXCHANGING GAUGE PARTS (LH-3578A-7 TYPE G).....	57
交換ゲージ部品一覧表（LH-3578A-7 G仕様）	
31. TABLE OF EXCHANGING GAUGE PARTS (LH-3588A-7 TYPE G).....	59
交換ゲージ部品一覧表（LH-3588A-7 G仕様）	
32. LIST FOR INFORMATION OF CHANGE.....	61
変更情報リスト	
NUMERICAL INDEX OF PARTS.....	62
索引	

1. FRAME & MISCELLANEOUS COVER COMPONENTS

頭部・外装関係

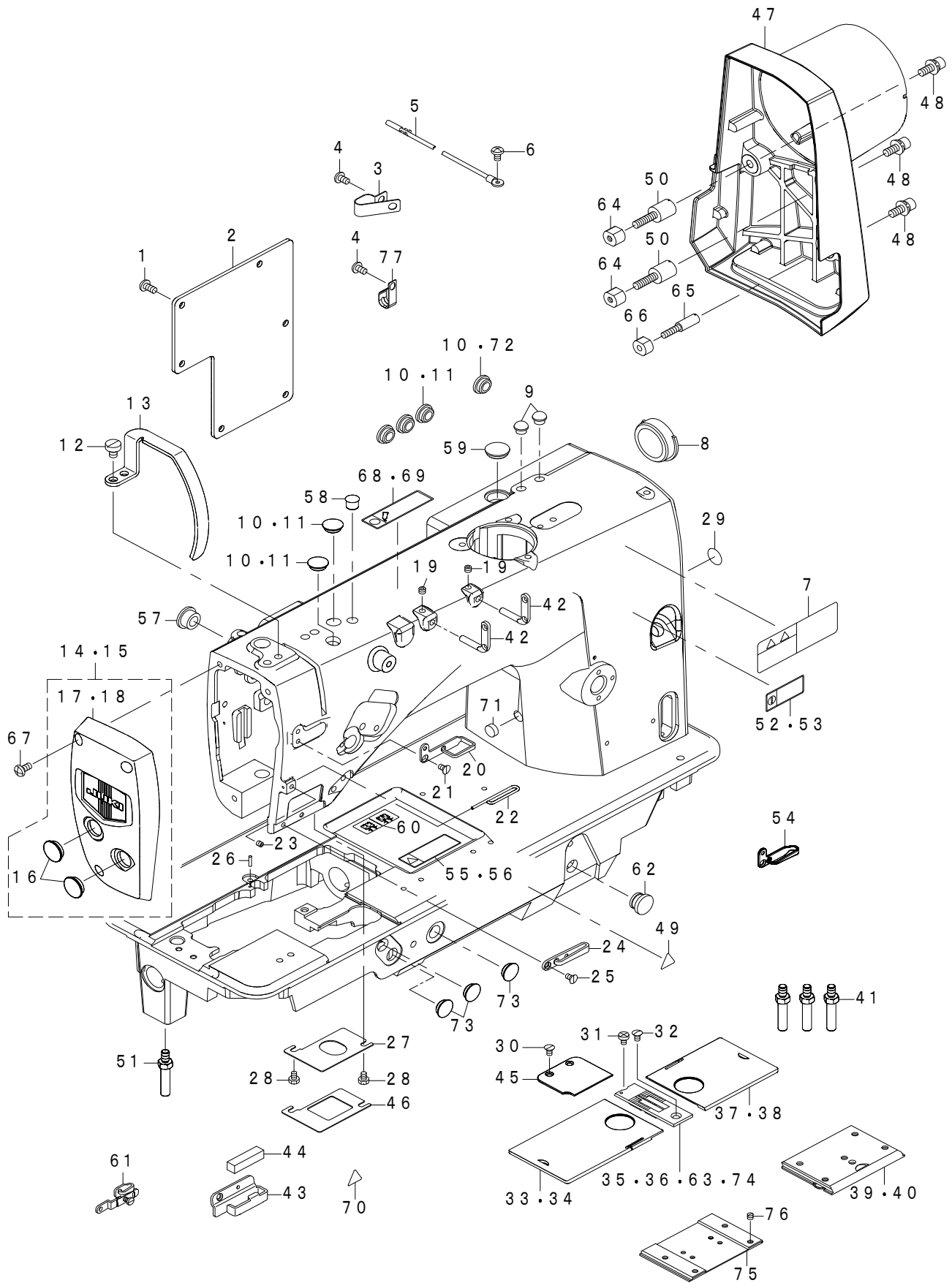

REF.NO	NOTE	PART NO	DESCRIPTION	品名	Qty
1		SM-4051255-SP	SCREW M5 L=12	なべねじ M5 L=12	6
2		400-28766	REAR_PLATE	窓板	1
3	#05	D2112-555-B00	CORD HOLDER LARGE	コード止め金具 A	3
4	#05	SM-4050855-SP	SCREW	なべねじ M5 L=8	4
5	#05	236-01057	EARTH CORD ASM.	アースコード (組)	1
6	#05	SM-4050855-SP	SCREW	なべねじ M5 L=8	1
7	#02	CM-3013000-01	SAFETY LABEL	頭部注意安全シール (横)	1
8	#01	226-19100	CAP	揺動軸穴キャップ (糸切り無し)	1
9	#01	TA-0800504-R0	PLUG D=8 L=4.5	止め栓 D=8 L=4.5	2
10	#08	TA-1250406-R0	RUBBER PLUG D=12.5 L=4	止め栓 D=12.5 L=4	6
11	#07	TA-1250406-R0	RUBBER PLUG D=12.5 L=4	止め栓 D=12.5 L=4	5
12		SM-6060800-SP	SCREW M6 L=8	平ねじ M6 L=8	2
13		400-28245	THREAD_TAKE_UP_LEVER_COVER	天祥カバー	1
14	#11	400-30298	ASSY_FACE_COVER_28	面板組28	1
15	#12	400-30299	ASSY_FACE_COVER_68	面板組68	1
16		TA-1600406-R0	PLUG	止め栓 D=16 L=3.5	(2)
17	#11	400-29641	FACE_COVER_28	面板28	(1)
18	#12	400-29972	FACE_COVER_68	面板68	(1)
19		SM-8050412-TP	SCREW M5 L=4	止めねじ M5 L=4	2
20		400-91179	THREAD_GUIDE_UPPER	糸案内 (上)	1
21		SM-1040750-TP	SCREW M4 L=7	皿小ねじ M4 L=7	1
22		400-29347	THREAD_GUIDE_WIRE	糸案内	1
23		SM-8040412-TP	SET SCREW M4 L=4	止めねじ	1
24		400-84142	THREAD_GUIDE_LOWER	糸案内下	1
25		SM-1040750-TP	SCREW M4 L=7	皿小ねじ M4 L=7	1
26		B1104-051-000	THROAT PLATE PIN	針板止めピン	1
27	#01	400-28730	PLATE	顎部当て板	1
28		SM-9040603-SC	SCREW M4 L=6	六角ボルト M4X0.7 L=6	2
29		229-01805	GROUND MARK	グラウンドマーク	1
30	#02	SM-1040750-TP	SCREW M4 L=7	皿小ねじ M4 L=7	2
31		SM-6040655-TP	SCREW M4 L=6	平小ねじ M4 L=6	1
32		SM-2040750-TP	SCREW M4 L=7.4	丸皿ねじ M4 L=7.4	1
33	#03	226-01058	BED SLIDE LEFT ASM. A	滑り板 (左) A組	1
34	#04	400-25247	ASSY_SLIDE_PLATE-L-A	糸切り滑り板左A組	1
35	#13	226-25503	THROAT PLATE 1/4	針板 (糸切り無し) 1/4 (6.4MM)	1
36	#14	400-25492	THROAT_PLATE_TRIM-1/4	糸切り針板 1/4	1
37	#03	226-00555	BED SLIDE RIGHT ASM. A	滑り板 (右) A組	1
38	#04	400-25235	ASSY_SLIDE_PLATE-R-A	糸切り滑り板右A組	1
39	#02	400-42880	ASSY_SLIDE_PLATE_F	滑り板前糸切り付き組	1
40	#01	400-42874	ASSY_SLIDE_PLATE_F_STANDARD	滑り板前糸切り無し組	1
41		400-96939	STUD	スタッド	3
42		229-20706	TWO EYELET	二爪糸掛け	2
43	#06	400-32896	THREAD_GUIDE_FELT	フェルト糸案内	1
44	☆	226-03708	FELT	フェルト	1
45	#02	400-28706	AUXILIARY_COVER	補助カバー	1
46	#10	400-28731	PLATE	顎部当て板	1
47	#05	400-91182	MOTOR_COVER	モータカバー	1
48	#05	SL-6061692-TN	BOLT	座金付き六角穴ボルト	3
49		CM-3002000-01	ATTENTION SEAL	指げが注意シール (16)	1
50	#05	400-91183	STUD_A	スタッドA	2
51		400-35180	BED_SCREW_STUD_B	ヘッド支柱B	1
52	#07	CM-2002002-01	LABEL_02_C	油注意シール (英中)	1
53	#08	CM-2002002-02	LABEL_02	油注意シール (和英)	1
54	#17	400-29078	THREAD_GUIDE_UPPER	糸案内上	1
55	#08	CM-3011001-02	LABEL_03	アタッチメント注意シール (和英)	1
56	#07	CM-3011001-01	LABEL_03_C	アタッチメント注意シール (英中)	1
57		TA-1470704-R0	RUBBER PLUG	止め栓	1
58		TA-0950806-R0	RUBBER PLUG	止め栓	1
59		TA-1650406-R0	PLUG	止め栓 D=17 L=3.5	1
60	#18	400-26811	THREADING DIAGRAM	糸通しシール	1
61	#17	400-34675	THREAD_GUIDE_ASM_E	針糸押え組	1
62		TA-1250705-R0	RUBBER PLUG	止め栓	1
63	#15	400-94772	THROAT PLATE 1/4	針板	1
64	#05	400-91184	STUD_B	スタッドB	2
65	#05	400-91185	STUD_C	スタッドC	1
66	#05	400-91186	STUD_D	スタッドD	1
67		SM-4051055-SP	SCREW	なべねじ	3
68	#08	CM-2001001-02	LABEL_01	グリース注意シール (和英)	1
69	#07	CM-2001001-01	LABEL_01_C	グリース注意シール (英中)	1
70		CM-3002000-03	ATTENTION LABEL	指げが注意シール (31.5)	1
71		TA-1030402-R0	RUBBER PLUG D=10.3 L=4	止め栓 D=10.3 L=4	1
72		TA-1050504-R0	RUBBER PLUG	止め栓	1
73		TA-1250406-R0	RUBBER PLUG D=12.5 L=4	止め栓 D=12.5 L=4	3
74	#16	400-94773	THROAT PLATE TRIM 1/4	針板糸切り	1
75	#09	232-06709	BED SLIDE (FRONT)A	滑り板 (前) A	1
76	#09	SS-8110410-TP	SCREW T1/64-40 L=3.5	止めねじ T1/64-40 L=3.5	1
77		401-36258	CORD HOLDER	コード押え	1
		NOTE(注記)	#01...FOR LH-3528A,3578A #02...FOR LH-3528A-7,3568A-7,3578A-7,3588A-7 #03...EXCHANGING GAUGE PARTS FOR LH-3528A,3568A,3578A,3588A #04...EXCHANGING GAUGE PARTS FOR LH-3528A-7,3568A-7,3578A-7,3588A-7 #05...FOR LH-3528A,7,3568A-7,3578A-7,3588A-7,3588A-7,3528A-0B #06...TYPE A(Accessorie Parts) #07...FOR CHINA #08...EXCEPT CHINA #09...SELECTIVE PARTS #10...FOR LH-3568A,3588A #11...FOR LH-3528A,3528A-7,3578A,3578A-7 #12...FOR LH-3568A,3568A-7,3588A,3588A-7 #13...EXCHANGING GAUGE PARTS FOR LH-3528A(TYPE S,A,F) #14...EXCHANGING GAUGE PARTS FOR LH-3528A-7(TYPE S,A,F) #15...EXCHANGING GAUGE PARTS FOR LH-3528A,3568A,3578A,3588A(TYPE G) #16...EXCHANGING GAUGE PARTS FOR LH-3528A-7,3568A-7,3578A-7,3588A-7(TYPE G) #17...TYPE G(Accessorie Parts) FOR LH-3578A,3578A-7,3588A,3588A-7 #18...TYPE A,F	LH-3528A,3578A 用 LH-3528A-7,3568A-7,3578A-7,3588A-7 用 交換ゲージ部品 LH-3528A,3568A,3578A,3588A 用 交換ゲージ部品 LH-3528A-7,3568A-7,3578A-7,3588A-7 用 LH-3528A,7,3568A-7,3578A-7,3588A-7,3588A-7,3528A-0B 用 A仕様 (付属品) 中国用 中国を除く 選択部品 LH-3568A,3588A 用 LH-3528A,3528A-7,3578A,3578A-7 用 LH-3568A,3568A-7,3588A,3588A-7 用 交換ゲージ部品 LH-3528A 用 (S,A,F仕様) 交換ゲージ部品 FOR LH-3528A-7 用 (S,A,F仕様) 交換ゲージ部品 LH-3528A,3568A,3578A,3588A(G仕様) 交換ゲージ部品 LH-3528A-7,3568A-7,3578A-7,3588A-7 用 (G仕様) G仕様 (付属品) LH-3578A,3578A-7,3588A,3588A-7 用 A,F仕様	

2. MAIN SHAFT & THREAD TAKE-UP COMPONENTS

上軸・天秤関係

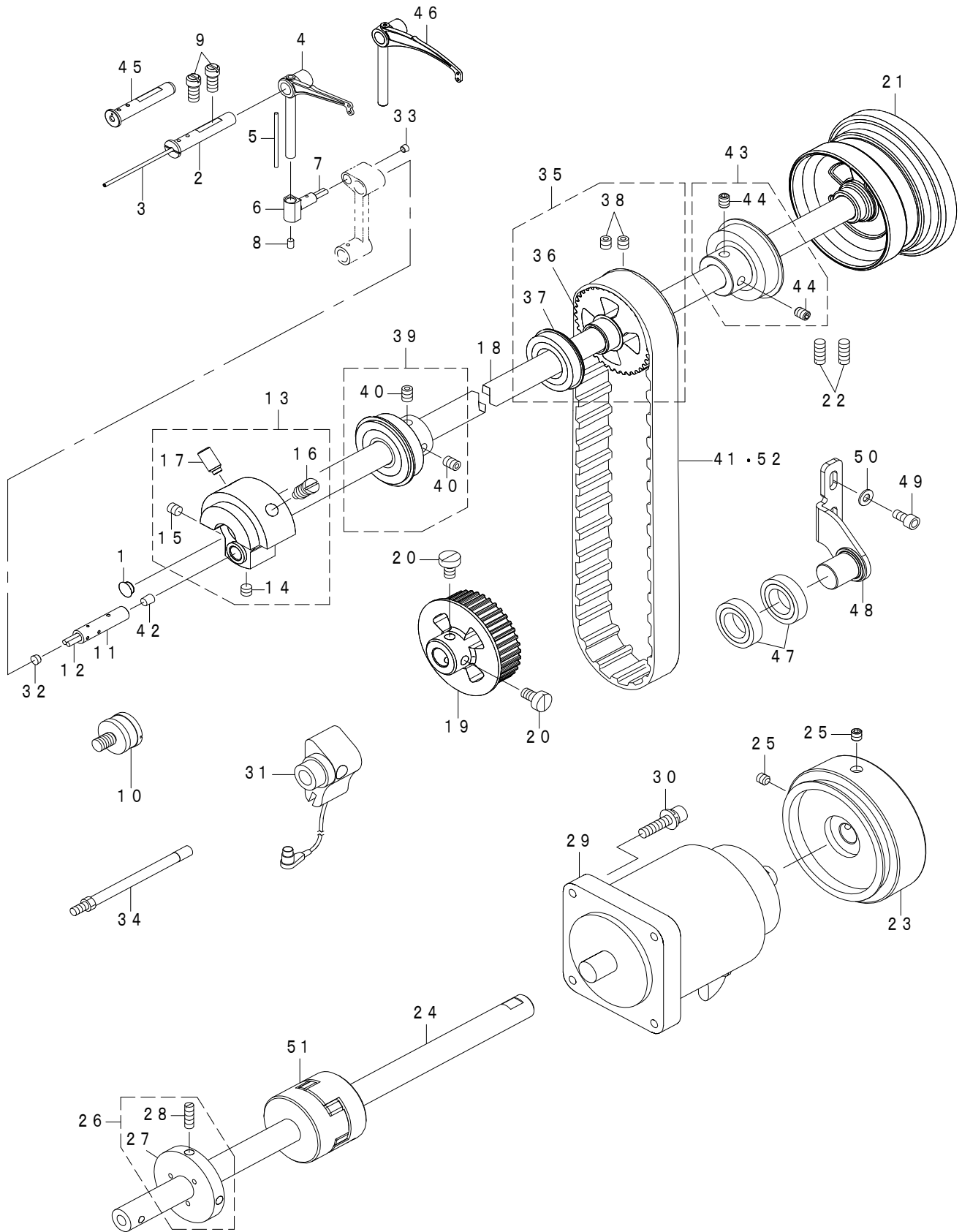

REF.NO	NOTE	PART NO	DESCRIPTION	品 名	Qty
1		TA-0750404-R0	PLUG D=7.5 L=3.5	止め栓 D=7.5 L=3.5	1
2		226-05307	THREAD TAKE-UP LEVER PIN	天秤支え軸	1
3		CQ-2020000-00	OIL WICK	油芯	0.15
4	★	400-24093	THREAD TAKE-UP LEVER_C	天秤C	1
5		CQ-2020000-00	OIL WICK	油芯	0.04
6		400-22678	TAKE_UP_LEVER_THRUST_PIN	天秤スラスト軸	1
7		CQ-2520000-00	OIL WICK	油芯	0.02
8		228-10907	RUBBER PLUG	天秤ゴム栓	1
9		400-10470	SHUTTLE_ASM_SCREW	大釜組止めねじ	2
10	#03	226-22401	SYNCRO FRNGE	シンクロフランジ	1
11		400-29964	NEEDLE_BAR_CRANK_PIN	針棒クランクピン	1
12		CQ-3030000-00	OIL WICK	油芯	0.02
13		400-31864	ASSY_COUNTER_WEIGHT	釣合錘組	1
14		SM-8060552-TP	SCREW M6 L=5	止めねじ	(1)
15		SM-8060612-TP	SCREW M6 L=6	止めねじ M6 L=6	(1)
16		400-04171	COUNTER_WEIGHT_SCREW	釣合錘止めねじ	(1)
17		SM-8081652-TP	SCREW M8 L=16	止めねじ M8 L=16	(1)
18	#01	400-24436	MAINSHAFT	上軸	1
19		400-28117	LOWER_SPROCKET	下軸スプロケット	1
20		SM-6061150-TP	SCREW M6 L=11	平小ねじ M6 L=11	2
21	#04	400-32987	HAND_WHEEL	はずみ車	1
22	#04	SM-8061550-TP	SCREW M6 L=15	止めねじ M6 L=15	2
23	#02	400-91181	HAND_WHEEL	はずみ車	1
24	#02	400-91180	MAIN_SHAFT	上軸	1
25	#02	SM-80608A2-TP	SCREW M6 L=8	六角穴付き止めねじ M6 L=8	2
26		400-20454	BTW DRIVING WHEEL ASM	糸巻き駆動車組	1
27		400-20455	BTW DRIVING WHEEL	糸巻き駆動車	(1)
28		SM-8051610-SP	SCREW M5 L=16	止めねじ M5 L=16	(2)
29	#02	400-91227	SERVO_MOTOR_550W	サーボモータ 550W	1
30	#02	SL-6052592-TN	BOLT	座金付き六角穴ボルト	4
31	#03	400-26920	SYNCHRONIZER ASM.	シンクロ組	1
32		TA-0500301-R0	PLUG 5X5.8 L=3	止め栓 5X5.8 L=3	1
33		TA-0370301-R0	PLUG D=3.7X4.4 L=3	止め栓 D=3.7X4.4 L=3	1
34	#03	400-32142	SENSOR_SUPPORT_SHAFT_ASM.	検出器支え軸	1
35		400-29048	ASSY_MAINSHAFT_BEARING_2	上軸中ベアリング組	1
36		400-28116	MAIN_SHAFT_SPROCKET	上軸スプロケット	(1)
37		SB-1200025-00	BEARING	ころがり軸受	(1)
38		SM-80608A2-TP	SCREW M6 L=8	六角穴付き止めねじ M6 L=8	(2)
39		401-42685	FRONT_BEARING	前ベアリング	1
40		400-10417	BEARING_BUSH_SCREW	上軸前ベアリングブッシュねじ	(2)
41	#07	400-28652	TIMING BELT	タイミングベルト	1
42		TA-0490601-R0	PLUG D=4.9X5.5 L=6	止め栓 D=4.9X5.5 L=6	1
43		401-50029	MAIN_SHAFT_BEARING	上軸後ベアリング	1
44		400-10417	BEARING_BUSH_SCREW	上軸ベアリングブッシュねじ	(2)
45	#05	400-98905	THREAD TAKE-UP LEVER_PIN_B	天秤支え軸	1
46	#05	400-43322	TAKE_UP_LEVER_E_COATING	天秤E	1
47	#06	SB-1170001-00	BEARING	ころがり軸受	2
48	#06	400-98038	IDLER_PLATE_ASM	アイドラ板組	1
49	#06	SM-6051002-TP	SCREW M5X0.8 L=10	六角穴ボルト M5X0.8 L=10	2
50	#06	WP-0501016-SD	WASHER 5X10.5X1	平座金 5X10.5X1	2
51	#02	401-42681	COUPLING_ASM.	カップリング組	1
52	#08	401-50036	TIMING BELT	タイミングベルト	1
		NOTE(注記)	#01...FOR LH-3528A,3568A,3578A,3588A #02...FOR LH-3528A-7,3568A-7, 3578A-7,3588A-7 #03...OPTIONAL PARTS (FOR LH-3528A,3568A,3578A,3588A) #04...FOR LH-3528A,3568A,3578A,3588A #05...FOR LH-3578A,3578A-7,3588A, 3588A-7 #06...FOR LH-3588A-7 #07...FOR LH-3588A,3588A-7 #08...EXCEPT LH-3588A,3588A-7	LH-3528A,3568A,3578A,3588A 用 LH-3528A-7,3568A-7,3578A-7,3588A-7 用 オプション部品 (LH-3528A,3568A,3578A,3588A 用) LH-3528A,3568A,3578A,3588A LH-3578A,3578A-7,3588A,3588A-7 用 LH-3588A-7 用 LH-3588A,3588A-7 用 LH-3588A,3588A-7 を除く	

REF.NO	NOTE	PART NO	DESCRIPTION	品名	Qty
1		402-36399	NEEDLE_BAR_ROCKING_BASE_ASM	針棒揺動台組(片針なし)	1
2		226-06800	OIL GUARD RUBBER	油防ゴム(片針無し)	1
3	☆	#03 MDP-500B1400	NEEDLE DPX5 #14	針 DPX5 #14	2
4	☆	#03 MDP-500B2100	NEEDLE DPX5 #21	針 DPX5 #21	2
5		#03 226-06206	SPACER Y	針落ちスペーサY	1
6		#03 226-06305	SPACER Z	針落ちスペーサZ	1
7		#03 226-07600	SPACER A	針落ちスペーサA	1
8		#03 226-07709	SPACER B	針落ちスペーサB	1
9		#03 B1438-512-B00	WASHER 17.1X28X1.5	揺動軸メタル座金 T=1.5	1
10		#03 226-07808	SPACER D	針落ちスペーサD	1
11		#03 226-07907	SPACER E	針落ちスペーサE	1
12		#03 226-06404	SPACER F	針落ちスペーサF	1
13		#03 232-04506	ROCKING ROD SQUARE BLOCK A	針棒クランクロッド角駒A	1
14		#03 232-04605	ROCKING ROD SQUARE BLOCK B	針棒クランクロッド角駒B	1
15		#03 232-04704	ROCKING ROD SQUARE BLOCK C	針棒クランクロッド角駒C	1
16		#02 400-26035	ASSY_NEEDLE_CLAMP(1/4)	針留め組(1/4)	1
17		SS-8080660-TP	SCREW 1/8-44 L=5.5	止めねじ 1/8-44 L=5.5	(2)
18		#02 101-48054	NEEDLE CLAMP ASM. 1/4"	針留め 1/4 組	1
19		SS-8080660-TP	SCREW 1/8-44 L=5.5	止めねじ 1/8-44 L=5.5	(2)
20		#01 400-28666	ROCKING_ROD_FIXING_BLOCK	固定台	1
21		#01 SM-6051002-TP	SCREW M5X0.8 L=10	六角穴ボルト M5X0.8 L=10	2
22		#01 WP-0550800-SP	WASHER 5.5X10X0.8	平座金 5.5X10X0.8	2
23		400-33669	ASSY_REAR_ARM	針棒揺動後部腕組	1
24		SM-6062502-TP	SCREW M6 L=25	六角穴ボルト M6 L=25	(1)
25		#03 401-43358	SHOULDER_SCREW_A	揺動ロッド段ねじA	1
26		400-32124	DRIVING_ROD_ASM.	針棒揺動ロッド組	1
27		400-28853	ASSY_DRIVING_ARM	針棒揺動送り腕組	1
28		SM-6051600-SP	SCREW M5 L=16	平ねじ M5 L=16	(1)
29		TA-0370301-R0	PLUG D-3.7X4.4 L=3	止め栓 D=3.7X4.4 L=3	2
30		#05 400-30037	NEEDLE_BAR_CRANK_ROD	針棒クランクロッド	1
31		402-36398	NEEDLE_BAR	針棒(片針無し)	1
32		400-23568	BUSHING	揺動前メタル	1
33	*	402-21500	BUSHING	揺動後メタル	1
34		400-31862	ASSY_NEEDLE_BAR_CONNECTION	針棒抱き組	1
35		SM-4041055-SP	SCREW	なべねじ M4 L=10	(1)
36		CQ-2520000-00	OIL WICK	油芯	(0.04)
37		400-40302	NEEDLE_BAR_CONNECTION	針棒抱き	(1)
38		#04 400-30038	NEEDLE_BAR_CRANK_ROD	針棒クランクロッド	1
39		#03 401-43359	SHOULDER_SCREW_B	揺動ロッド段ねじB	1
40		#03 401-43360	THRUST_PIN_A	揺動ロッドスラストピンA	1
41		#03 401-43361	THRUST_PIN_B	揺動ロッドスラストピンB	1
42		CS-087101B-SH	THRUST COLLAR ASM. D=8.73 W=10	スラスト受 D=8.73 W=10 組	1
43		CS-0871019-SH	THRUST COLLAR D=8.73 W=10	スラスト受 D=8.73 W=10	(1)
44		SS-8150822-TP	SCREW 15/64-28 L=8	止めねじ 15/64-28 L=8	(2)
45		NM-6060001-CP	NUT M6	六角ナット M6	1
46	*	SM-6060802-TP	SCREW M6 L=8	ロッククアチ ボルト M6 L=8	1
		NOTE(注記)	#01....FOR LH-3528A	LH-3528A 用	
			#02....EXCHANGING GAUGE PARTS	交換ゲージ部品	
			#03....SELECTIVE PARTS	選択部品	
			#04....FOR LH-3578A,3578A-7	LH-3578A,3578A-7 用	
			#05....FOR LH-3528A,3528A-7	LH-3528A,3528A-7 用	

4. NEEDLE BAR COMPONENTS (2)(FOR LH-3568A,LH-3568A-7,3588A,3588A-7)

針棒關係 (2) (LH-3568A,3568A-7,3588A,3588A-7 用)

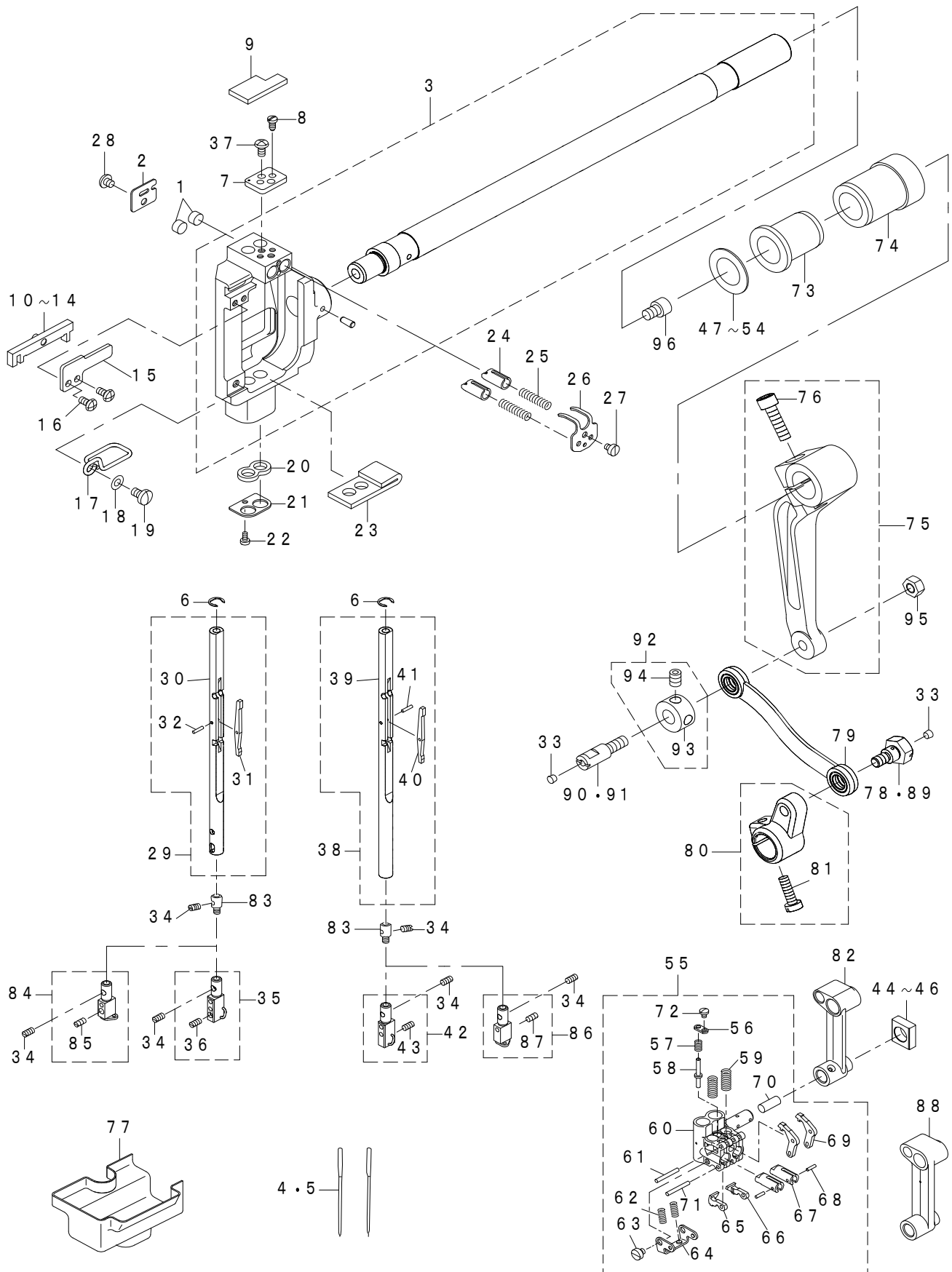

REF.NO	NOTE	PART NO	DESCRIPTION	品名	Qty
1		110-02904	ROLLER FELT	面部油量調節フェルト	2
2		226-81209	FELT COVER	フェルト押え	1
3		400-26402	NEEDLE_BAR_ROCKING_BASE_ASM.	針棒揺動台組	1
4	☆	#01	MDP-500B1400	NEEDLE DPX5 #14	2
5	☆	#01	MDP-500B2100	NEEDLE DPX5 #21	2
6		401-66315	RING_Z	リングZ	2
7		226-82702	NEEDLE BAR SWIVEL STOPPER	針棒回り止め	1
8		226-81712	STOPPER SCREW	針棒回り止め 止めねじ	2
9		400-39629	FELT	フェルト	1
10	#01	226-81951	SLIDER BLOCK ASM. A	滑り子(組) A	1
11	#01	226-82058	SLIDER BLOCK ASM. B	滑り子(組) B	1
12	#01	226-82157	SLIDE BLOCK	滑り子(組) C	1
13	#01	226-82256	SLIDER BLOCK ASM. D	滑り子(組) D	1
14	#01	226-82355	SLIDER BLOCK ASM. E	滑り子(組) E	1
15		226-81803	SLIDE BLOCK GUIDE PLATE	滑り子案内板	1
16		SS-4090715-SP	SCREW 9/64-40 L=7	なべねじ 9/64-40 L=7	2
17		226-85903	FELT GUIDE	針棒油防フェルトガイド	1
18		WP-0450000-SD	WASHER 4.5X8X0.5	平座金 4.5X8X0.5	1
19		SS-7110710-SP	SCREW 11/64-40 L=7	丸平ねじ 11/64-40 L=7	1
20		226-86000	NEEDLE BAR OIL SEAL FELT A	針棒油防フェルト A	1
21		226-85804	NEEDLE BAR OIL SEAL PLATE	針棒油防板	1
22		SS-6060510-TP	SCREW 3/32-56 L=4.5	平ねじ 3/32-56 L=4.5	1
23		226-86109	NEEDLE BAR OIL SEAL FELT B	針棒油防フェルト B	1
24		226-81407	NEEDLE BAR STOPPER	針棒油防ストッパー	2
25		226-81506	SPRING	針棒油防ストッパーばね	2
26		400-95222	STOPPER_SPRING_COVER	針棒ストッパーばねカバー	1
27		SS-6080410-SP	SCREW 1/8-44 L=4	平ねじ 1/8-44 L=4	1
28		SS-4090415-SP	SCREW 9/64-40 L=4	なべねじ 9/64-40 L=4	1
29		400-26983	NEEDLE_BAR_ASM_LEFT	針棒左組	1
30		400-26982	NEEDLE_BAR_LEFT	針棒左	(1)
31		226-85200	SEESAW PLATE	シーソー板	(1)
32		226-85408	NEEDLE BAR PIN	針棒ピン	(1)
33		TA-0370301-R0	PLUG D-3.7X4.4 L=3	止め栓 D=3.7X4.4 L=3	2
34		B1425-526-000	SCREW 1/8-44 L=6	針留め止めねじ	4
35	#02	400-29561	ASSY_NEEDLE_CLAMP_L(1/4)	針留め左組 1/4	1
36		SS-8080660-TP	SCREW 1/8-44 L=5.5	止めねじ 1/8-44 L=5.5	(2)
37		SS-4090715-SP	SCREW 9/64-40 L=7	なべねじ 9/64-40 L=7	2
38		400-26984	NEEDLE_BAR_ASM_RIGHT	針棒右組	1
39		400-26981	NEEDLE_BAR_RIGHT	針棒右	(1)
40		226-85200	SEESAW PLATE	シーソー板	(1)
41		226-85408	NEEDLE BAR PIN	針棒ピン	(1)
42	#02	400-29562	ASSY_NEEDLE_CLAMP_R(1/4)	針留め右組 1/4	1
43		SS-8080660-TP	SCREW 1/8-44 L=5.5	止めねじ 1/8-44 L=5.5	(2)
44	#01	232-04506	ROCKING ROD SQUARE BLOCK A	針棒クランクロッド角駒A	1
45	#01	232-04605	ROCKING ROD SQUARE BLOCK B	針棒クランクロッド角駒B	1
46	#01	232-04704	ROCKING ROD SQUARE BLOCK C	針棒クランクロッド角駒C	1
47	#01	226-06206	SPACER Y	針落ちスベサY	1
48	#01	226-06305	SPACER Z	針落ちスベサZ	1
49	#01	226-07600	SPACER A	針落ちスベサA	1
50	#01	226-07709	SPACER B	針落ちスベサB	1
51	#01	B1438-512-B00	WASHER 17.1X28X1.5	揺動軸メタル座金 T=1.5	1
52	#01	226-07808	SPACER D	針落ちスベサD	1
53	#01	226-07907	SPACER E	針落ちスベサE	1
54	#01	226-06404	SPACER F	針落ちスベサF	1
55		400-32147	NEEDLE_BAR_CONNECTION_ASM	針棒抱き組	1
56		400-59036	RELEASE_PIN_COVER	リリースピン蓋	(1)
57		226-83304	SPRING	リリースピンばね	(1)
58		400-24473	RELEASE_PIN	リリースピン	(1)
59		226-83809	SPRING	針棒クラッチてこばね	(2)
60		400-28679	NEEDLE_BAR_CONNECTION	針棒抱き	(1)
61		226-83403	NEEDLE BAR CONNECTION PIN	針棒抱きピン	(1)
62		226-84104	SPRING	クラッチストッパーばね	(2)
63		SS-6080340-SP	SCREW 1/8-44 L=2.9	平ねじ 1/8-44 L=2.9	(2)
64		226-84203	SPRING BRACKET	クラッチストッパーばね支え	(1)
65		226-83908	CLUTCH STOPPER LEFT	針棒クラッチストッパー(左)	(1)
66		226-84005	CLUTCH STOPPER RIGHT	針棒クラッチストッパー(右)	(1)
67		400-24064	NEEDLE_BAR_CLUTCH	針棒クラッチ	(2)
68		B1705-850-000	STOPPER PIN	ストッパーピン	(2)
69		226-83601	CLUTCH LEVER	クラッチレバー	(2)
70		CQ-2520000-00	OIL WICK	油芯 (0.03)	
71		400-15144	NEEDLE BAR CONNECTION PIN	針棒抱きピン	(1)
72		SS-7060310-SP	SCREW 3/32-56 L=3	丸平ねじ 3/32-56 L=3	(1)
73		400-23568	BUSHING	揺動軸メタル	1
74	*	402-21500	BUSHING	揺動後メタル	1
75		400-33669	ASSY_REAR_ARM	針棒揺動後部腕組	1
76		SM-6062502-TP	SCREW M6 L=25	六角穴ネルト M6 L=25	(1)
77		226-85705	OIL GUARD RUBBER	油防ゴム(片針付き)	1
78	#01	401-43358	SHOULDER_SCREW_A	揺動ロッド段ねじA	1
79		400-32124	DRIVING_ROD_ASM	針棒揺動ロッド組	1
80		400-28853	ASSY_DRIVING_ARM	針棒揺動送り腕組	1
81		SM-6051600-SP	SCREW M5 L=16	平ねじ M5 L=16	(1)
82	#04	400-28200	NEEDLE_BAR_CRANK_ROD	針棒クランクロッド	1
83		226-82504	SPRING BEARING	ばね受	2
84	#02	B1402-528-FAL-A	NEEDLE CLAMP ASM. 1/4	針留め左 1/4組	1
85		SS-8080660-TP	SCREW 1/8-44 L=5.5	止めねじ 1/8-44 L=5.5	(2)
86	#02	B1402-528-FAR-A	NEEDLE CLAMP ASM. 1/4	針留め右 1/4組	1
87		SS-8080660-TP	SCREW 1/8-44 L=5.5	止めねじ 1/8-44 L=5.5	(2)
88	#03	400-30027	NEEDLE_BAR_CRANK_ROD	針棒クランクロッド	1
89	#01	401-43359	SHOULDER_SCREW_B	揺動ロッド段ねじB	1
90	#01	401-43360	THRUST_PIN_A	揺動ロッドスラストピンA	1
91	#01	401-43361	THRUST_PIN_B	揺動ロッドスラストピンB	1
92		CS-087101B-SH	THRUST COLLAR ASM. D=8.73 W=10	スラスト受 D=8.73 W=10 組	1
93		CS-0871019-SH	THRUST COLLAR D=8.73 W=10	スラスト受 D=8.73 W=10	(1)
94		SS-8150822-TP	SCREW 15/64-28 L=8	止めねじ 15/64-28 L=8	(2)
95		NM-6060001-CP	NUT M6	六角ナット M6	1
96	*	SM-6060802-TP	SCREW M6 L=8	ロックワッシャーネルト M6 L=8	1

NOTE(注記)

#01...SELECTIVE PARTS
#02...EXCHANGING GAUGE PARTS
#03...FOR LH-3568A,3568A-7
#04...FOR LH-3568A,3568A-7

選択部品
交換ゲージ部品
LH-3568A,3568A-7用
LH-3568A,3568A-7用

5. TENSION POST COMPONENTS (1)(LH-3528A,3528A-7 TYPE S/G)(LH-3578A,3578A-7 TYPE G)

糸調子関係 (1) (LH-3528A,3528A-7 S/G 仕様) (LH-3578A,3578A-7 G 仕様)

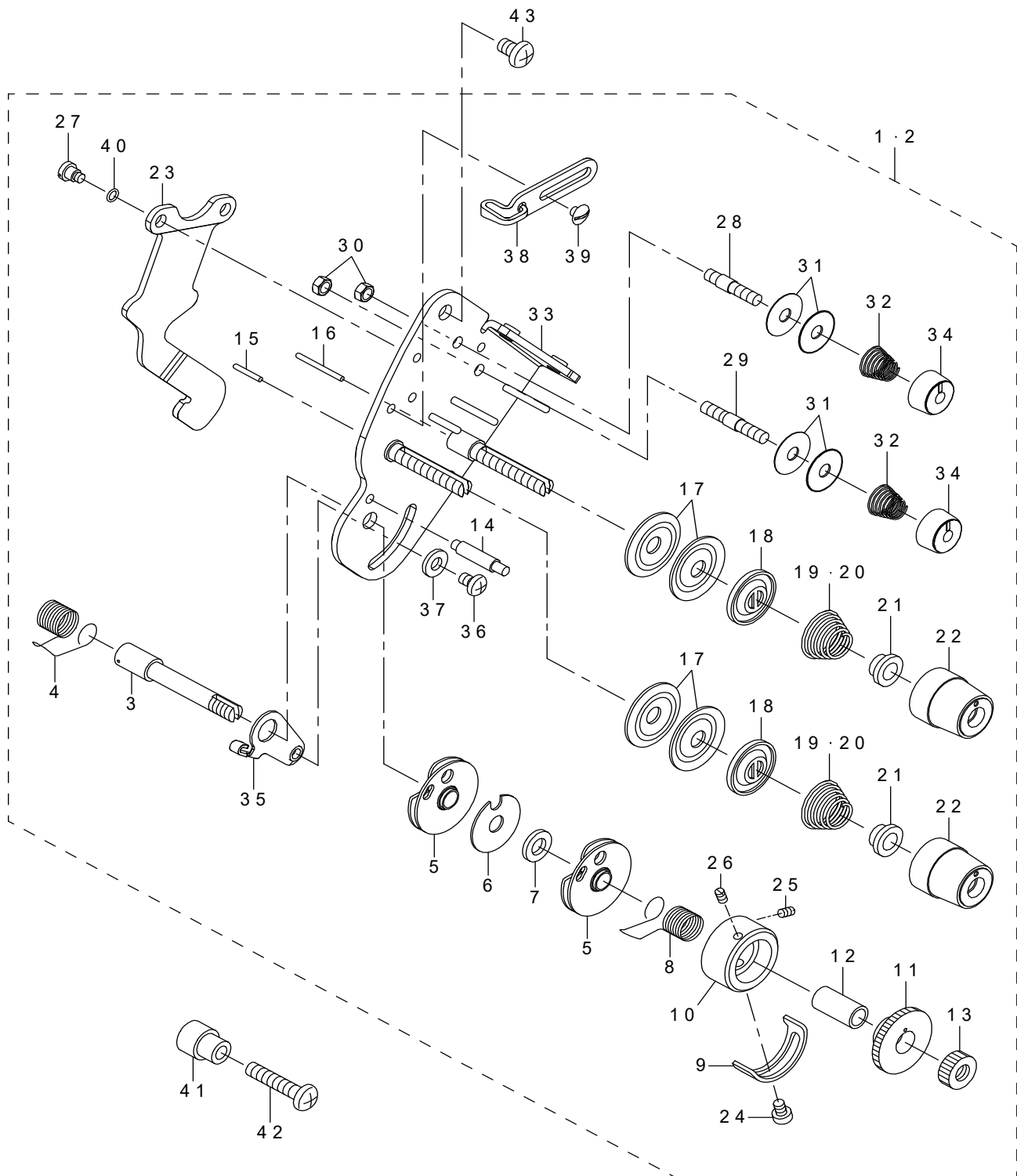

REF.NO	NOTE	PART NO	DESCRIPTION	品名	Qty
1	#01	400-91191	COMP_THREAD_TENSION_MAL28S	糸調子(組) 28S	1
2	#02	400-94770	COMP_THREAD_TENSION_MAL28G	糸調子(組) 28G	1
3		106-97605	THREAD TAKE-UP SPRING STUD	糸取りばね軸	(1)
4	☆	226-18706	THREAD TAKE-UP SPRING A	糸取りばねA	(2)
5		B3137-527-0A0	TAKE-UP SPRING GUIDE ASM.	糸取りばね案内組	(1)
6		B3142-527-000	TAKE-UP SPRING GUIDE PLATE	糸取りばね案内板	(1)
7		B3139-527-000	COLLAR	糸取りばね軸カラー	(1)
8	☆	226-18805	THREAD TAKE-UP SPRING B	糸取りばねB	(1)
9		B3138-527-000	ADJUSTING PLATE B	糸取りばね調節板B	(1)
10		226-17609	THREAD TENSION POST	糸取りばね掛け土台	(1)
11		226-17708	TAKE-UP SPRING GUIDE	糸取りばね掛け	(1)
12		B3141-527-000	PRESSER COLLAR	糸取りばね案内押え	(1)
13		226-17807	NUT	糸取りばね軸ナット	(1)
14		B3143-527-000	TAKE-UP SPRING GUIDE STUD	糸取りばね掛け土台軸	(1)
15		226-18201	TENSION RELEASE PIN A	糸緩めピン(A)	(1)
16		226-18300	TENSION RELEASE PIN B	糸緩めピン(B)	(1)
17		B3126-012-000	THREAD TENSION DISK	糸調子皿	(4)
18		226-17906	THREAD TENSION DISK PRESSER	糸調子皿押え	(2)
19	#01	B3129-012-A00	TENSION SPRING	糸調子ばね A	(2)
20	#02	B3114-232-000	THREAD TENSION SPRING	糸調子ばね	(2)
21		B3112-704-000	TENSION SPRING BUSHING	ばねブッシュ	(2)
22		119-57008	THREAD TENSION KNOB	糸調子つまみ(無色)	(2)
23		400-91259	DISK_RELEASE_PLATE_B	皿浮かし板B	(1)
24		SS-7090510-SP	SCREW 9/64-40 L=4.6	丸平ねじ 9/64-40 L=4.6	(1)
25		226-18904	SET SCREW	糸取りばね掛け止めねじ	(1)
26		226-18904	SET SCREW	糸取りばね掛け止めねじ	(1)
27		SD-0470316-TP	SHOULDER SCREW D=4.7 H=3.1	段ねじ D=4.7 H=3.1	(2)
28		101-24204	THREAD TENSION POST A	第一糸調子棒A	(1)
29		101-24303	THREAD TENSION POST B	第一糸調子棒B	(1)
30		NS-6110310-SP	NUT 11/64-40	六角ナット 11/64-40	(2)
31		107-41106	FIRST THREAD TENSION PLATE	第一糸調子皿	(4)
32		110-45101	THREAD TENSION SPRING	第一糸調子ばね	(2)
33		400-91258	ASSY_TENSION_BASE_PLATE28	糸調子板組	(1)
34		110-72402	THREAD TENSION NUT	第一糸調子ナット	(2)
35		106-97506	THREAD TENSION BRACKET A	糸取りばね調節板(A)	(1)
36		SS-4110615-SP	SCREW 11/64-40 L=6	なべ小ねじ 11/64-40 L=6	(1)
37		WP-0501016-SD	WASHER 5X10.5X1	平座金 5X10.5X1	(1)
38		400-83824	THREAD TAKE_UP_GUIDE_B	天秤糸案内B	(1)
39		SS-5090420-SP	SCREW 9/64-40 L=3.5	トラスねじ 9/64-40 L=3.5	(2)
40		RO-0360802-00	RUBBER RING	Oリング	(2)
41		400-91193	STUD	糸調子スタッド	1
42		SM-4052501-SN	SCREW M5X0.8 L=25	止めねじ M5X0.8 L=25	1
43		SM-4051001-SN	SCREW M5	なべ小ねじ M5X0.8 L=10	1
		NOTE(注記)	#01....TYPE S #02....TYPE G	S仕様 G仕様	

6. TENSION POST COMPONENTS (2)(LH-3528A TYPE A/F)

糸調子関係 (2) (LH-3528A A/F 仕様)

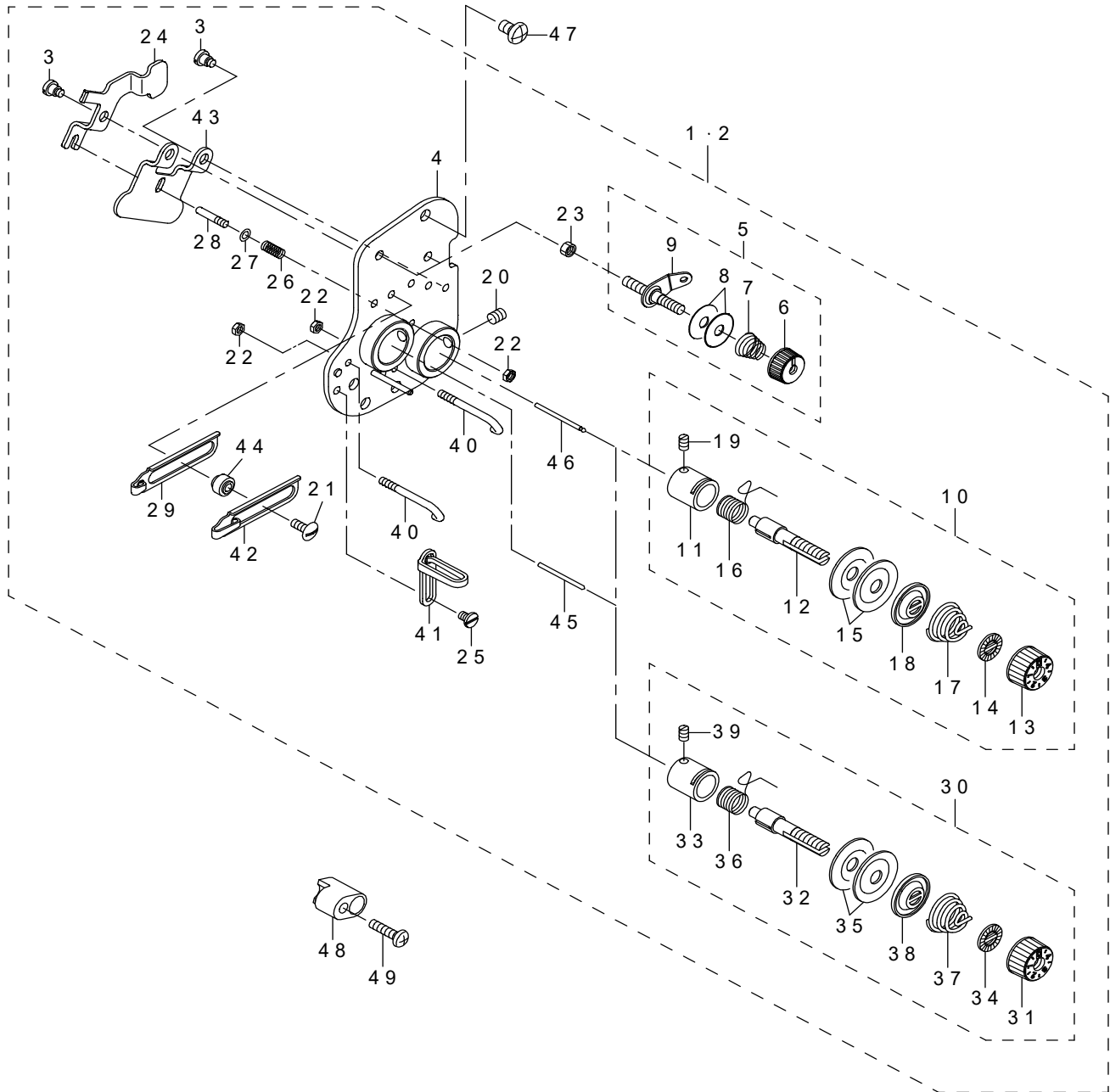

REF.NO	NOTE	PART NO	DESCRIPTION	品名	Qty
1	#01	400-32707	COMP_THREAD_TENSION_28S	糸調子組28S	1
2	#02	400-32709	COMP_THREAD_TENSION_28A	糸調子組28A	1
3		SD-0470316-TP	SHOULDER SCREW D=4.7 H=3.1	段ねじ D=4.7 H=3.1	(3)
4		400-28250	ASSY_TENSION_BASE_PLATE	糸調子板組	(1)
5		400-52366	ASSY_THREAD_TENSION	第一糸調子組	(2)
6		110-72402	THREAD TENSION NUT	第一糸調子ナット	(1)
7		229-45505	THREAD TENSION SPRING	第一糸調子ばね	(1)
8		B3214-047-000	BOBBIN WINDER TENSION DISC	糸調子皿	(2)
9		225-29473	BOBBIN THREAD TENSION ROD ASM.	糸巻き糸調子棒結合	(1)
10	#01	400-56698	THREAD TENSION ASM.	糸調子組	(1)
11		229-45307	THREAD TENSION POST BASE	糸調子棒台	(1)
12		229-21209	THREAD TENSION POST	糸調子棒	(1)
13		236-26005	THREAD TENSION NUT	糸調子ナット	(1)
14		229-21407	ROTATION STOPPER	糸調子皿回転止め	(1)
15		229-21506	THREAD TENSION DISK	糸調子皿	(2)
16	☆	229-21605	THREAD TAKE-UP SPRING	イトトリバネ	(1)
17		B3129-012-A00	TENSION SPRING	糸調子ばねA	(1)
18		229-21803	DISK STOPPER	糸調子皿押え	(1)
19		SS-8090670-SP	SCREW 9/64-40 L=5.5	止めねじ 9/64-40 L=5.5	(1)
20		SM-8050612-TP	SCREW M5X6	止めねじ M5X0.8 L=6	(2)
21		SS-5091020-SP	SCREW 9/64-40 L=9.5	トラスねじ 9/64-40 L=9.5	(2)
22		NS-6080210-SP	NUT 1/8-44	六角ナット 1/8-44	(3)
23		NS-6110310-SP	NUT 11/64-40	六角ナット 11/64-40	(2)
24		400-34840	RELEASE_LEVER	皿緩め板	(1)
25		SS-6090520-SP	SCREW 9/64-40 L=5.0	平ねじ 9/64-40 L=5	(1)
26		400-09222	PRESSER PLATE ADJUSTING SPRING	押し板調節ばね	(1)
27		WP-0350516-SD	WASHER 3.5X6X0.5	平座金 3.5X6X0.5	(1)
28		400-15699	SPRING_GUIDE	スプリングガイド	(1)
29		400-60689	THREAD_TAKE_UP_GUIDE	天秤糸案内	(1)
30	#02	400-80006	ASSY_THREAD_TENSION_A	糸調子(組)A	(1)
31		236-26005	THREAD TENSION NUT	糸調子ナット	(1)
32		B3115-552-000	TENSION POST	糸調子棒	(1)
33		B3111-126-000	TENSION POST SOCKET	糸調子棒台	(1)
34		B3120-125-000	ROTATING STOPPER	糸調子皿回転止め	(1)
35		131-38201	THREAD TENSION DISK	糸調子皿	(2)
36	☆	D3128-555-D00	TAKE-UP SPRING	糸取りばね	(1)
37		D3129-555-D00	THREAD TENSION SPRING	糸調子ばね	(1)
38		B3132-552-000	THREAD TENSION DISK PRESSER	糸調子皿押え	(1)
39		SS-8090670-SP	SCREW 9/64-40 L=5.5	止めねじ 9/64-40 L=5.5	(1)
40		400-49219	THREAD_GUIDE	糸案内	(2)
41		400-60693	THREAD_GUIDE_UPPER_A	糸案内 上 A	(1)
42		400-60840	THREAD_TAKE_UP_GUIDE_B	天秤糸案内 B	(1)
43		400-34660	DISK_RELEASE_PLATE	皿緩め板	(1)
44		232-03300	THREAD GUIDE COLLAR	糸案内カラー	(2)
45		B3118-552-F00	TENSION RELEASING PIN	糸緩めピン F	(1)
46		B3118-552-I00	TENSION RELEASING PIN I	糸緩めピン I	(1)
47		SM-4050855-SP	SCREW	なべねじ M5 L=8	2
48		400-91194	TENSION_STUD_A	糸調子スタッド(A)	1
49		SM-4041601-SN	SCREW	なべ小ねじ M4X0.7 L=16	1
		NOTE(注記)	#01....TYPE F #02....TYPE A	F仕様 A仕様	

7. TENSION POST COMPONENTS (3)(LH-3568A,3568A-7 TYPE S/G)(LH-3588A,3588A-7 TYPE G)

糸調子関係 (3) (LH-3568A,3568A-7 S/G 仕様) (LH-3588A,3588A-7 G 仕様)

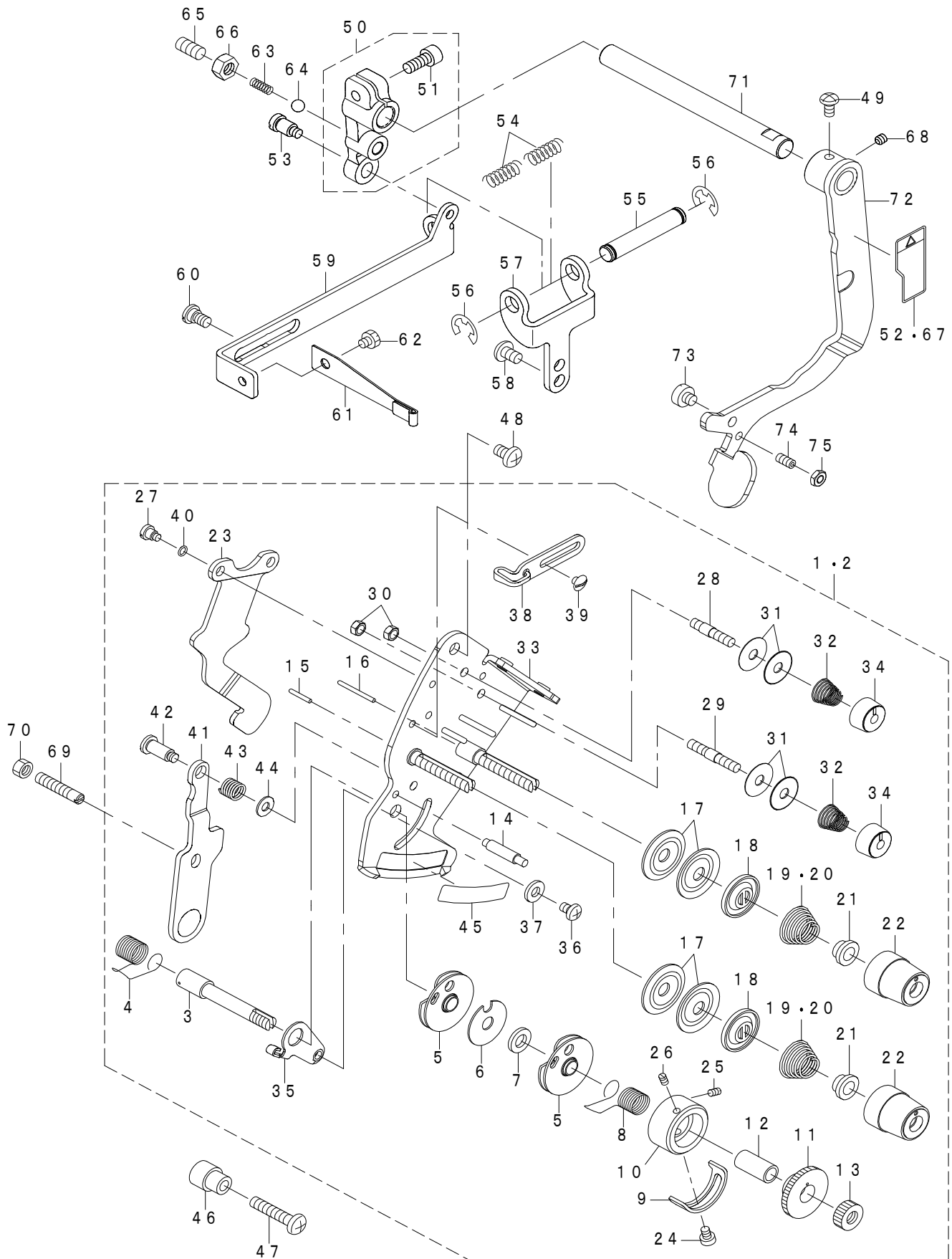

REF.NO	NOTE	PART NO	DESCRIPTION	品名	Qty
1	#01	400-91192	COMP_THREAD_TENSION_MAL68S	糸調子(組) 68S	1
2	#02	400-94771	COMP_THREAD_TENSION_MAL68G	糸調子(組) 68G	1
3		106-97605	THREAD TAKE-UP SPRING STUD	糸取りばね軸	(1)
4	★	226-18706	THREAD TAKE-UP SPRING A	糸取りばねA	(1)
5		B3137-527-0A0	TAKE-UP SPRING GUIDE ASM.	糸取りばね案内組	(2)
6		B3142-527-000	TAKE-UP SPRING GUIDE PLATE	糸取りばね案内板	(1)
7		B3139-527-000	COLLAR	糸取りばね軸カラー	(1)
8	★	226-18805	THREAD TAKE-UP SPRING B	糸取りばねB	(1)
9		B3138-527-000	ADJUSTING PLATE B	糸取りばね調節板B	(1)
10		226-17609	THREAD TENSION POST	糸取りばね掛け土台	(1)
11		226-17708	TAKE-UP SPRING GUIDE	糸取りばね掛け	(1)
12		B3141-527-000	PRESSER COLLAR	糸取りばね案内押え	(1)
13		226-17807	NUT	糸取りばね軸ナット	(1)
14		B3143-527-000	TAKE-UP SPRING GUIDE STUD	糸取りばね掛け土台軸	(1)
15		226-18201	TENSION RELEASE PIN A	糸緩めピン(A)	(1)
16		226-18300	TENSION RELEASE PIN B	糸緩めピン(B)	(1)
17		B3126-012-000	THREAD TENSION DISK	糸調子皿	(4)
18		226-17906	THREAD TENSION DISK PRESSER	糸調子皿押え	(2)
19	#01	B3129-012-A00	TENSION SPRING	糸調子ばねA	(2)
20	#02	B3114-232-000	THREAD TENSION SPRING	糸調子ばね	(2)
21		B3112-704-000	TENSION SPRING BUSHING	ばねブッシュ	(2)
22		119-57008	THREAD TENSION KNOB	糸調子つまみ(無色)	(2)
23		400-91259	DISK_RELEASE_PLATE_B	皿浮かし板B	(1)
24		SS-7090510-SP	SCREW 9/64-40 L=4.6	丸平ねじ 9/64-40 L=4.6	(1)
25		226-18904	SET SCREW	糸取りばね掛け止めねじ	(1)
26		226-18904	SET SCREW	糸取りばね掛け止めねじ	(1)
27		SD-0470316-TP	SHOULDER SCREW D=4.7 H=3.1	段ねじ D=4.7 H=3.1	(2)
28		101-24204	THREAD TENSION POST A	第一糸調子棒A	(1)
29		101-24303	THREAD TENSION POST B	第一糸調子棒B	(1)
30		NS-6110310-SP	NUT 11/64-40	六角ナット 11/64-40	(2)
31		107-41106	FIRST THREAD TENSION PLATE	第一糸調子皿	(4)
32		110-45101	THREAD TENSION SPRING	第一糸調子ばね	(2)
33		400-91265	ASSY_TENSION_BASE_PLATE68	糸調子板組68	(1)
34		110-72402	THREAD TENSION NUT	第一糸調子ナット	(2)
35		106-97506	THREAD TENSION BRACKET A	糸取りばね調節板(A)	(1)
36		SS-4110615-SP	SCREW 11/64-40 L=6	なべ小ねじ 11/64-40 L=6	(1)
37		WP-0501016-SD	WASHER 5X10.5X1	平座金 5X10.5X1	(1)
38		400-83824	THREAD TAKE_UP_GUIDE_B	天秤糸案内B	(1)
39		SS-5090420-SP	SCREW 9/64-40 L=3.5	トラスねじ 9/64-40 L=3.5	(2)
40		RO-0360802-00	RUBBER RING	Oリング	(2)
41		400-91266	REPOSITIONING_RELEASE_LEVER	解除レバー	(1)
42		SD-0601171-SP	HINGE SCREW D=6 H=11.7	段ねじ D=6 H=11.7	(1)
43		B1449-526-000	REPOSITIONING LEVER SPRING	変換固定レバーばね	(1)
44		WP-0450801-SP	WASHER	平座金	(1)
45		400-91267	TENSION_PLATE_LABEL	糸調子ラベル	(1)
46		400-91193	STUD	糸調子スタッド	1
47		SM-4052501-SN	SCREW M5X0.8 L=25	止めねじ M5X0.8 L=25	1
48		SM-4051001-SN	SCREW M5	なべ小ねじ M5X0.8 L=10	1
49		SM-4040855-SP	SCREW	なべねじ	1
50		400-32327	ASSY_REPOSITIONING_ARM	交換腕(組)	1
51		SM-6051202-TP	SCREW M5X0.8 L=12	六角穴ボルト M5X0.8 L=12	(1)
52	#04	CM-3004009-02	LABEL_04	片針注意シール(和英)	1
53		SD-0640752-TP	HINGE SCREW D=6.35 H=7.5	段ねじ D=6.35 H=7.5	1
54		226-87503	SPRING	変換ばね	2
55		226-87701	SPRING SHAFT	変換ばね軸	1
56		RE-0700000-K0	E-RING 7	E形止め輪 7	2
57		226-87602	SPRING BASE	変換ばね土台	1
58		SM-4050855-SP	SCREW	なべねじ M5 L=8	2
59		226-87107	REPOSITIONING PLATE	交換板	1
60		SD-0640247-TP	SHOULDER SCREW D=6.35 H=2.4	段ねじ D=6.35 H=2.4	2
61		226-87008	LEAF SPRING	滑り逃がしばね	1
62		SS-9110460-CP	SCREW 11/64-40 L=4	六角ボルト 11/64-40 L=4	1
63		400-28641	ADJUSTING_SPRING	調節ねじ	1
64		226-15702	OIL ADJUSTING BALL	釜油量調節ボール	1
65		SM-8061212-TP	SCREW M6X12	止めねじ M6 L=12	1
66		NM-6060001-CP	NUT M6	六角ナット M6	1
67	#03	CM-3004009-01	LABEL_04_C	片針注意シール(英中)	1
68		SM-8040412-TP	SET SCREW M4 L=4	止めねじ	1
69		400-28843	LEVER_PIN_SCREW	変換レバーピンねじ	1
70		NM-6050001-SD	NUT M5X0.8	六角ナット M5X0.8 1種	1
71		400-28844	REPOSITIONING_LEVER_SHAFT	変換レバー軸	1
72		400-91206	ASSY_REPOSITIONING_LEVER	変換レバー(組)	1
73		SM-6050450-TP	SCREW M5 L=4	平小ねじ M5 L=4	1
74		SM-8040802-TP	SCREW M4X8	止めねじ M4X0.7 L=8	1
75		NM-6040003-SC	NUT M4	六角ナット M4	1
		NOTE(注記)	#01....TYPE S #02....TYPE G #03....FOR CHINA #04....EXCEPT CHINA	S仕様 G仕様 中国用 中国を除く	

8. HOOK & HOOK DRIVING SHAFT COMPONENTS (1)

釜・下軸関係 (1)

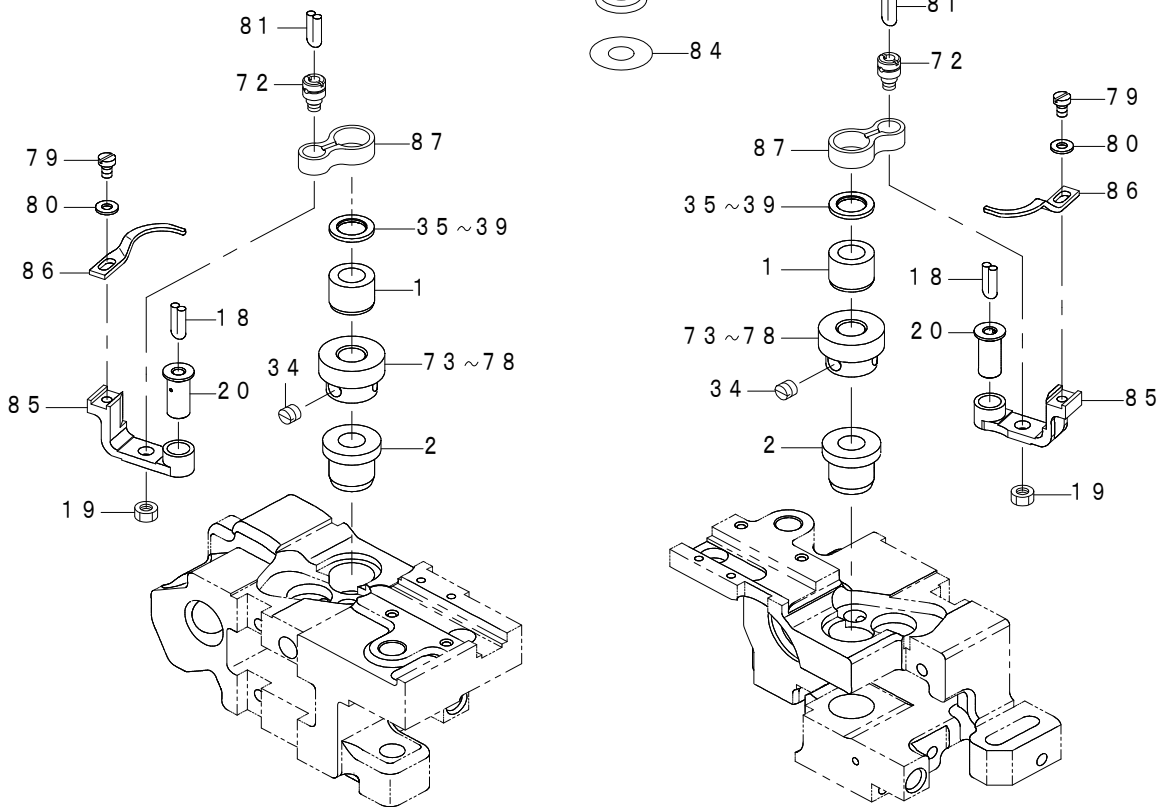
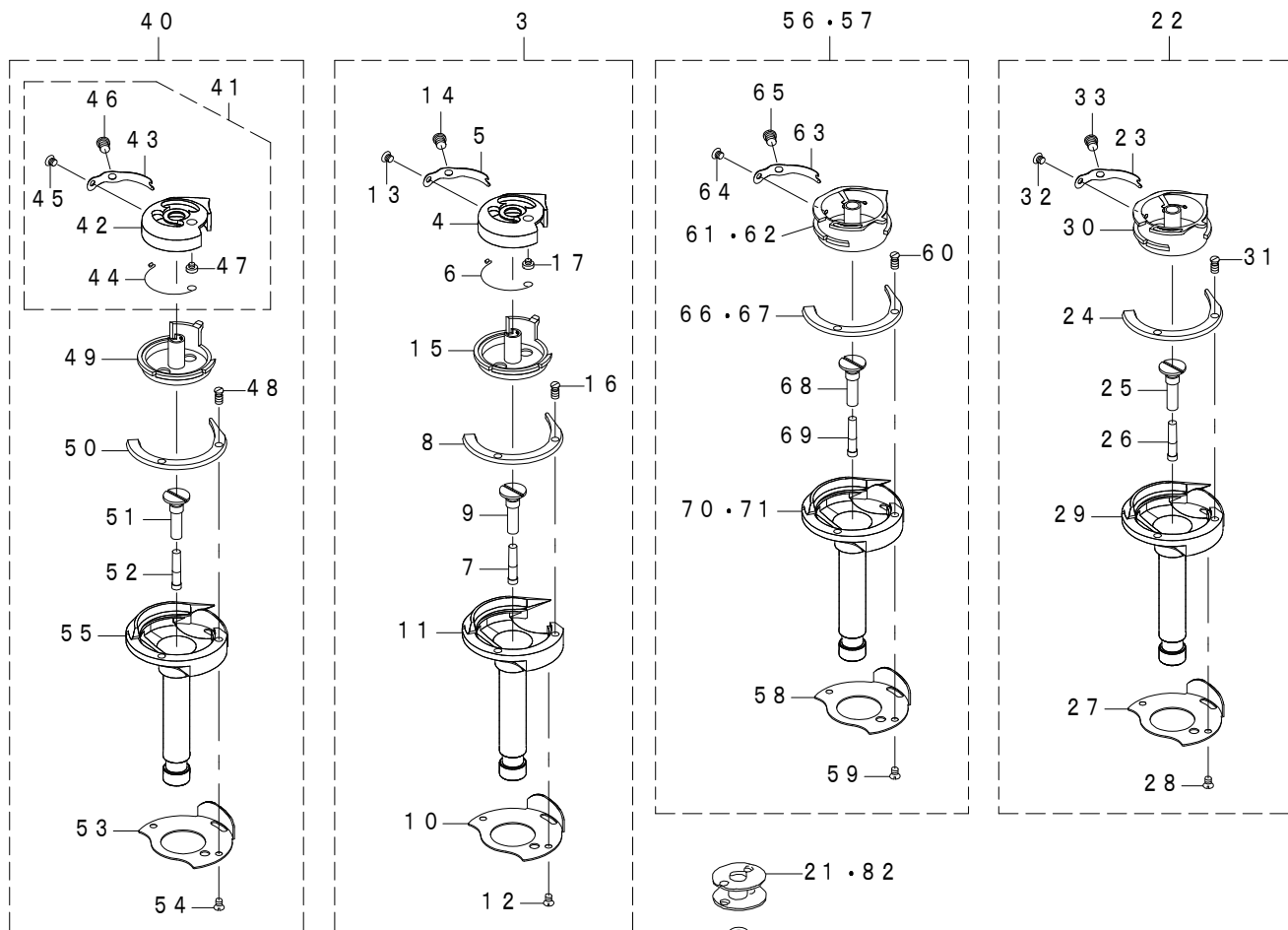

REF.NO	NOTE	PART NO	DESCRIPTION	品名	Qty
1		400-42121	HOOK_UPPER_BUSH	釜軸上メタル	2
2		401-04436	HOOK_LOWER_BUSH	釜軸下メタル	2
3	★ #02	400-91144	ASSY-CAP_HOOK	片針釜(組)	2
4		226-88105	BOBBIN CASE	ボビンケース(片針用)	(1)
5	★	226-88402	TENSION ADJUSTING SPRING	下糸調子ばね(0.3)	(1)
6	★	226-88204	SPRING	下糸吸収ばね	(1)
7		110-15906	OIL WICK	シモジクマエトメネジユシン	(1)
8		400-36689	HOOK_GIB_TRIM	中釜押え(糸切り)	(1)
9		400-12085	OIL_PLUG	オイルプラグ	(1)
10		226-12303	NEEDLE POSITIONER	針受	(1)
11		400-36687	OUTER_HOOK_TRIM	糸切り外釜	(1)
12		101-12902	SCREW	針受止めねじ	(2)
13		101-10500	TENSION SPRING INSTALLING SCREW	下糸調子ばね止めねじ	(1)
14		226-12907	TENSION ADJUSTING SCREW	下糸張力調節ねじ	(1)
15		226-12709	BOBBIN BASKET	キャップ中釜	(1)
16		101-12803	SCREW	押え止めねじ	(2)
17		SS-6560150-SH	SCREW 3/32-80 L=1.3	平ねじ 3/32-80 L=1.3	(1)
18		CQ-2020000-00	OIL WICK	油芯	0.3
19		NS-6110420-SP	NUT 11/64-40	六角ナット 11/64-40	2
20		B1823-051-000	OPENING LEVER CRANK PIN	中釜案内腕軸	2
21	★	B9117-051-000	BOBBIN	ボビン	2
22	★ #03	400-91143	ASSY-RATCH_HOOK	ラッチ釜(組)	2
23	★	226-12402	BOBBIN CASE TENSION SPRING	下糸調子ばね(0.25)	(2)
24		400-36689	HOOK_GIB_TRIM	中釜押え(糸切り)	(2)
25		400-12085	OIL_PLUG	オイルプラグ	(2)
26	★	110-15906	OIL WICK	下軸前止めねじ油芯	(1)
27		226-12303	NEEDLE POSITIONER	針受	(2)
28		101-12902	SCREW	針受止めねじ	(2)
29		400-36686	OUTER_HOOK	外釜	(1)
30		226-12105	SWING HOOK	ラッチ中釜	(1)
31		101-12803	SCREW	押え止めねじ	(2)
32		101-10500	TENSION SPRING INSTALLING SCREW	下糸調子ばね止めねじ	(1)
33		101-10609	TENSION ADJUSTING SCREW	下糸張力調節ねじ	(1)
34		SM-8060550-TP	SCREW M6 L=4.5	止めねじ M6 L=4.5	6
35	#01	226-14002	THRUST WASHER A	釜軸上メタルスペーサ A	2
36	#01	226-14101	THRUST WASHER B	釜軸上メタルスペーサ B	2
37	#01	226-14200	SPACER C	釜軸上メタルスペーサ C	2
38	#01	101-12605	THRUST WASHER 1.7	釜軸上メタル スラスト板 1.7	2
39	#01	101-12704	THRUST WASHER 1.8	釜軸上メタル スラスト板 1.8	2
40	★ #04	400-36685	ASSY-CAP_HOOK_TRIM	糸切り片針釜(組)	2
41		226-88154	BOBBIN CASE ASM	ボビンケース(片針用)組	(1)
42		226-88105	BOBBIN CASE	ボビンケース(片針用)	(1)
43		226-88402	TENSION ADJUSTING SPRING	下糸調子ばね(0.3)	(1)
44		226-88204	SPRING	下糸吸収ばね	(1)
45		101-10500	TENSION SPRING INSTALLING SCREW	下糸調子ばね止めねじ	(1)
46		226-12907	TENSION ADJUSTING SCREW	下糸張力調節ねじ	(1)
47		SS-6560150-SH	SCREW 3/32-80 L=1.3	平ねじ 3/32-80 L=1.3	(1)
48		101-12803	SCREW	押え止めねじ	(2)
49		400-39391	CAP_INNERHOOK	キャップ中釜(糸切り)	(1)
50		400-36689	HOOK_GIB_TRIM	中釜押え(糸切り)	(1)
51		400-12085	OIL_PLUG	オイルプラグ	(1)
52		110-15906	OIL WICK	下軸前止めねじ油芯	(1)
53		226-12303	NEEDLE POSITIONER	針受	(1)
54		101-12902	SCREW	針受止めねじ	(2)
55		400-36687	OUTER_HOOK_TRIM	糸切り外釜	(1)
56	★ #05	400-36683	ASSY-RATCH_HOOK_TRIM	糸切りラッチ釜(組)	2
57	#07	400-36682	ASSY-RATCH_HOOK	ラッチ釜(組)	2
58		226-12303	NEEDLE POSITIONER	針受	(1)
59		101-12902	SCREW	針受止めねじ	(2)
60		101-12803	SCREW	押え止めねじ	(2)
61	#05	400-36688	RATCH_INNERHOOK_TRIM	ラッチ中釜(糸切り)	(1)
62	#07	226-12105	SWING HOOK	ラッチ中釜	(1)
63		226-12402	BOBBIN CASE TENSION SPRING	下糸調子ばね(0.25)	(1)
64		101-10500	TENSION SPRING INSTALLING SCREW	下糸調子ばね止めねじ	(1)
65		101-10609	TENSION ADJUSTING SCREW	下糸張力調節ねじ	(1)
66	#05	400-36689	HOOK_GIB_TRIM	中釜押え(糸切り)	(1)
67	#07	226-12204	HOOK_GIB	中釜押え	(1)
68		400-12085	OIL_PLUG	オイルプラグ	(1)
69		110-15906	OIL WICK	下軸前止めねじ油芯	(1)
70	#05	400-36687	OUTER_HOOK_TRIM	糸切り外釜	(1)
71	#07	400-36686	OUTER_HOOK	外釜	(1)
72		B1821-051-000	CRANK SCREW STUD	中釜案内クランクピン	2
73	★ #08	401-51853	HOOK_SHAFT_GEAR_A	釜軸ギヤ A	2
74	★ #08	401-51854	HOOK_SHAFT_GEAR_B	釜軸ギヤ B	2
75	#08	401-51855	HOOK_SHAFT_GEAR_C	釜軸ギヤ C	2
76	#08	401-51856	HOOK_SHAFT_GEAR_D	釜軸ギヤ D	2
77	#08	401-51857	HOOK_SHAFT_GEAR_E	釜軸ギヤ E	2
78	#08	401-51858	HOOK_SHAFT_GEAR_F	釜軸ギヤ F	2
79		SS-6090810-TP	SCREW 9/64-40 L=7.5	平ねじ 9/64-40 L=7.5	2
80		WP-0371016-SD	WASHER 3.7X8X1	平座金 3.7X8X1	2
81		CQ-2020000-00	OIL WICK	油芯	0.3
82	★ #06	102-10805	HARD ALUMITE BOBBIN	硬質アルマイトボビン	2
83	★ #06	101-11508	SPRING	空転防止ばね	2
84	★ #06	226-53802	SHEET	空転防止シート	2
85		B1822-051-000	OPENING LEVER CRANK	中釜案内腕	2
86		400-79641	OPENING_LEVER	中釜案内	2
87		402-58716	BOBBIN CASE OPENING LEVER LINK	ナカガマンナイリンク	2
		NOTE(注記)	#01...SELECTIVE PARTS #02...FOR LH-3568A #03...FOR LH-3528A #04...FOR LH-3568A-7 #05...FOR LH-3528A-7,LH-3568A-7 TYPE FA #06...FOR LH-3528A-7,LH-3568A-7 #07...FOR LH-3528A(TYPE A,F), LH3568A TYPE FA #08...SELECTIVE PARTS (FOR LH-3528A-7,LH-3568A-7)	選択部品 LH-3568A 用 LH-3528A 用 LH-3568A-7 用 LH-3528A-7,LH-3568A-7 FA 仕様 LH-3528A-7,LH-3568A-7 用 LH-3528A 用(A,F仕様) LH3568A FA仕様 選択部品 (LH-3528A-7,LH-3568A-7 用)	

9. HOOK & HOOK DRIVING SHAFT COMPONENTS (1)(FOR LH-3578A,3578A-7,3588A,3588A-7)

釜・下軸関係 (2) (LH-3578A,3578A-7,3588A,3588A-7 用)

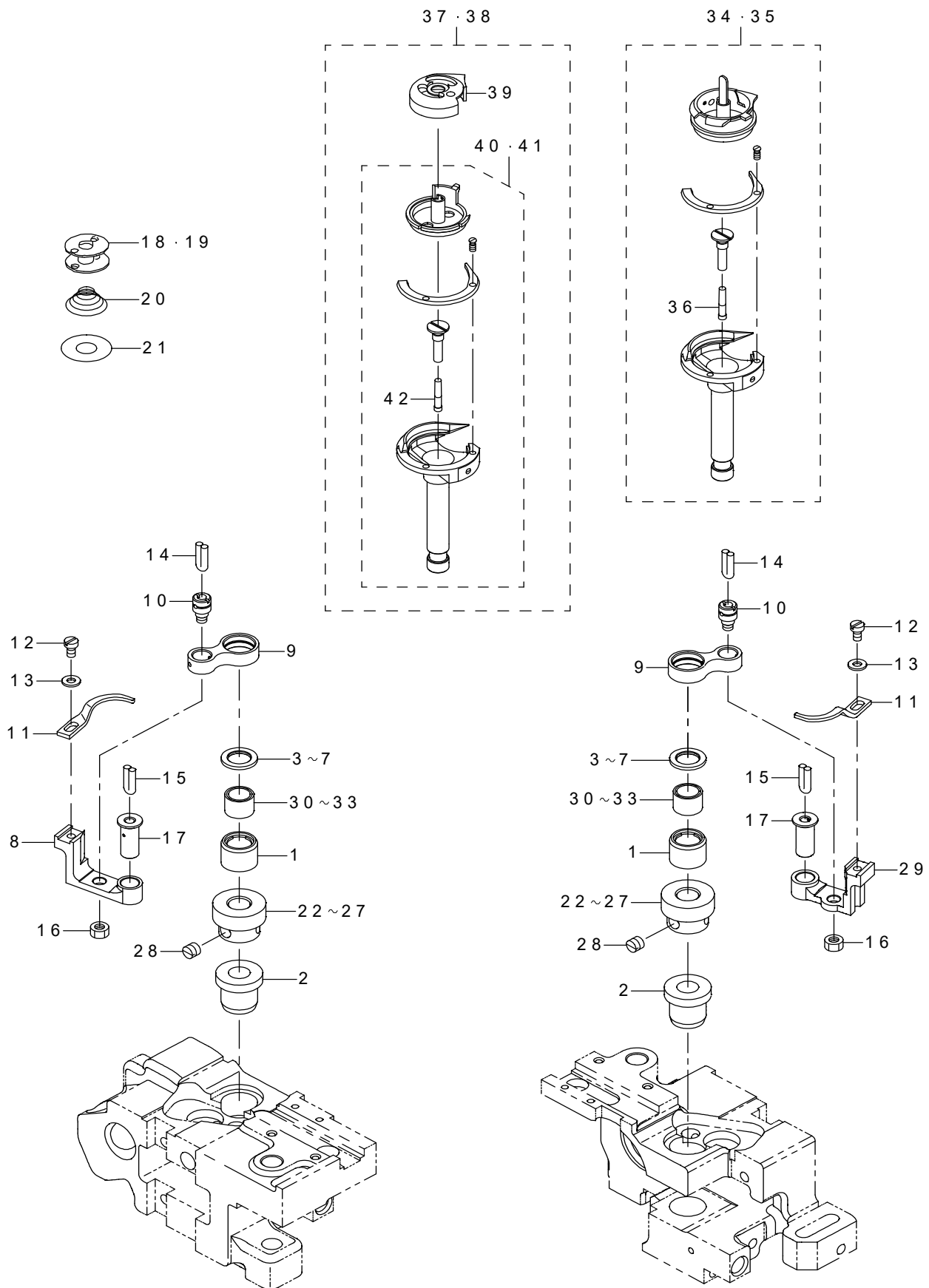

REF.NO	NOTE	PART NO	DESCRIPTION	品名	Qty	
1		400-50003	HOOK_SHAFT_BUSH_A	釜軸上メタルA	2	
2		401-04436	HOOK_LOWER_BUSH	釜軸下メタル	2	
3	#01	101-11201	THRUST WASHER F	釜軸上メタル スラストイタ 1. 4	2	
4	#01	101-09809	THRUST WASHER B	釜軸上メタル スラストイタ B	2	
5	#01	101-12506	THRUST WASHER 1.6	釜軸上メタル スラストイタ 1. 6	2	
6	#01	101-11003	THRUST WASHER 1.2	釜軸上メタル スラストイタ 1. 2	2	
7	#01	101-11102	THRUST WASHER 1.3	釜軸上メタル スラストイタ 1. 3	2	
8		228-13109	OPENING LEVER CRANK	中釜案内腕 (大釜)	1	
9		228-13000	BOBBIN CASE OPENING LEVER LINK	中釜案内リンク (大釜)	2	
10		B1821-051-000	CRANK SCREW STUD	中釜案内クランクピン	2	
11		400-57361	OPENING_LEVER	中釜案内	2	
12		SS-6090810-TP	SCREW 9/64-40 L=7.5	平ねじ 9/64-40 L=7. 5	2	
13		WP-0371016-SD	WASHER 3.7X8X1	平座金 3. 7X8X1	2	
14		CQ-2020000-00	OIL WICK	油芯	0.3	
15		CQ-2020000-00	OIL WICK	油芯	0.3	
16		NS-6110420-SP	NUT 11/64-40	六角ナット 11/64-40	2	
17		B1823-051-000	OPENING LEVER CRANK PIN	中釜案内腕軸	2	
18	☆	#02	B9117-563-000	BOBBIN	2	
19	☆	* #03	402-35203	BOBBIN	2	
20	☆	#03	400-55358	SPRING_L	空転防止ばね L	2
21	☆	#03	228-19809	SHEET	空転防止シート (大釜)	2
22		#09	401-53307	HOOK_SHAFT_GEAR_MM_A	釜軸ギヤ (半半完品) A	2
23		#09	401-53308	HOOK_SHAFT_GEAR_MM_B	釜軸ギヤ (半半完品) B	2
24		#09	401-53309	HOOK_SHAFT_GEAR_MM_C	釜軸ギヤ (半半完品) C	2
25		#09	401-53310	HOOK_SHAFT_GEAR_MM_D	釜軸ギヤ (半半完品) D	2
26		#09	401-53311	HOOK_SHAFT_GEAR_MM_E	釜軸ギヤ (半半完品) E	2
27		#09	401-53312	HOOK_SHAFT_GEAR_MM_F	釜軸ギヤ (半半完品) F	2
28		SM-8060550-TP	SCREW M6 L=4.5	止めねじ M6 L=4. 5	6	
29		400-53371	INNERHOOK_GUIDE_ARM_R	中釜案内腕 (大釜) 右	1	
30		#01	SB-3095301-0A	NEEDLE BEARING 9.525X9.52	ニードルベアリング 9. 525X9. 52	2
31		#01	SB-3095301-0B	NEEDLE BEARING	ニードルベアリング 9. 525X9. 52	2
32		#01	SB-3095301-0C	NEEDLE BEARING 9.525X9.52	ニードルベアリング 9. 525X9. 52	2
33		#01	SB-3095301-0D	BEARING	ニードルベアリング 9. 525X9. 52	2
34	☆	#04	400-43333	ASSY_RATCH_LARGEHOOK	ラッチ大釜 (組)	2
35	☆	#05	400-43334	ASSY_RATCH_LARGEHOOK(T)	糸切りラッチ大釜 (組)	2
36		110-15906	OIL WICK	シモジクマエトメネジユシン	(1)	
37	☆	#06	400-43335	ASSY_LARGEHOOK	片針大釜 (組)	2
38	☆	#07	400-43336	ASSY_LARGEHOOK(T)	片針糸切り大釜 (組)	2
39		#08	228-27257	BOBBIN CASE ASM.	ボビンケース (片針付き) 組	(1)
40		#06	400-59786	LARGE HOOK EXCEPT CAP	キャップ無し片針大釜	(1)
41		#07	400-59787	LARGE HOOK TRIM EXCEPT CAP	キャップ無し片針大釜糸切り	(1)
42		110-15906	OIL WICK	下軸前止めねじ油芯	(1)	
		NOTE(注記)	#01...SELECTIVE PARTS #02...FOR LH-3578A,3588A #03...FOR LH-3578A-7,3588A-7 #04...FOR LH-3578A,LH-3588A TYPE FA #05...FOR LH-3578A-7(TYPE A,F), LH-3588A-7 TYPE FA #06...FOR LH-3588A #07...FOR LH-3588A-7 #08...FOR LH-3588A,3588A-7 #09...SELECTIVE PARTS (FOR LH-3588A,3588A-7)	選択部品 LH-3578A,3588A 用 LH-3578A-7,3588A-7 用 LH-3578A,LH-3588A FA 仕様 LH-3578A-7 用 (A,F 仕様) LH-3588A-7 FA 仕様 LH-3588A 用 LH-3588A-7 用 LH-3588A,3588A-7 用 選択部品 (LH-3588A,3588A-7 用)		

REF.NO	NOTE	PART NO	DESCRIPTION	品名	Qty
1		400-28271	LOWER_SHAFT	下軸	1
2		401-04434	LOWER_SHAFT_BUSH-F	下軸前メタル	1
3		401-04435	LOWER_SHAFT_BUSH-M	下軸中メタル	1
4		400-31351	ASSY-LOWER_SHAFT_COLLAR	下軸スラストカラー (組)	1
5		SM-8060612-TP	SCREW M6 L=6	止めねじ M6 L=6	(2)
6		400-13061	THRUST_WASHER	スラスト座金	1
7		236-18804	OIL SEAL	上下送り軸後ろオイルシール	1
8	#01	400-28485	HOOK_SHAFT_BASE-L	釜軸台 (左)	1
9	#02	400-28487	HOOK_SHAFT_BASE-L-TRIM	糸切り釜軸台 (左)	1
10	#03	400-34969	HOOK_SHAFT_BASE_L	釜軸台 (左) 小釜	1
11	#04	400-34971	HOOK_SHAFT_BASE_L-TRIM	糸切り釜軸台 (左) 小釜	1
12	#01	400-28486	HOOK_SHAFT_BASE-R	釜軸台 (右)	1
13	#02	400-28488	HOOK_SHAFT_BASE-R-TRIM	糸切り釜軸台 (右)	1
14	#03	400-34970	HOOK_SHAFT_BASE_R	釜軸台 (右) 小釜	1
15	#04	400-34972	HOOK_SHAFT_BASE_R-TRIM	糸切り釜軸台 (右) 小釜	1
16		400-42141	OIL_ADJUSTING_SCREW	オイル調節ねじ	2
17		RO-0442401-00	RUBBER RING	Oリング	2
18		400-29570	OIL_ADJUSTING_SPRING	油量調節ばね	2
19		TA-0290301-M0	PLUG	止め栓 D=2.9 X 3.2 L=3	6
20		SM-8051002-TP	SCREW M5 L=10	止めねじ	2
21		101-09908	SADDLE INSTALLING BLOCK UPPER	釜軸台止め上	2
22		101-12407	SADDLE INSTALLING BLOCK LOWER	釜軸台止め下	2
23		SS-6153040-SP	SCREW 15/64-28 L=30	平ねじ 15/64-28 L=30	2
24		SM-6063750-SP	SCREW M6 L=37	平小ねじM6 L=37	1
25		WP-0621046-SP	WASHER	平座金	2
26		400-22589	BOTTOM_COVER	釜軸台蓋	2
27		400-22590	BOTTOM_COVER_GASKET	釜軸台パッキン	2
28		SM-4050855-SP	SCREW	なべねじ M5 L=8	8
29		SQ-2050453-MZ	CONNECTING SCREW	パイプ連結ねじ	4
30		TA-0290301-M0	PLUG	止め栓 D=2.9 X 3.2 L=3	6
31		SM-6062500-SP	SCREW M6 L=25	平小ねじ M6 L=25	1
32		400-28495	GEAR_GUIDE-L	ギヤガイド (左)	1
33		400-28496	GEAR_GUIDE-R	ギヤガイド (右)	1
34		SM-4050855-SP	SCREW	なべねじ M5 L=8	4
35		SQ-2060451-MZ	CONNECTING SCREW	パイプ連結ねじ	2
36	#07	401-51866	LOWER_SHAFT_GEAR	下軸ギヤ	2
37		SM-8060610-TP	SCREW	止めねじ M6 L=6	4
38		SM-80608A2-TP	SCREW M6 L=8	六角穴付き止めねじ M6 L=8	1
39		SM-80608A2-TP	SCREW M6 L=8	六角穴付き止めねじ M6 L=8	1
40		401-50033	LOWER_SHAFT_BEARING	下軸ベアリング	1
41		SM-8060612-TP	SCREW M6 L=6	止めねじ M6 L=6	(2)
42		RO-2573501-00	O-RING	Oリング	1
43		228-88507	OIL SEAL	送りレバー軸オイルシール	2
44		400-11947	LOWER_PLUNGER_BUSH	下軸プランジャーメタル	1
45		SQ-2050453-MZ	CONNECTING SCREW	パイプ連結ねじ	2
46	#05	400-43921	L-HOOK_SHAFT_BASE-L	大釜釜軸台 (左)	1
47	#06	400-43923	L-HOOK_SHAFT_BASE-L-TRIM	大釜糸切り釜軸台 (左)	1
48	#05	400-43922	L-HOOK_SHAFT_BASE-R	大釜釜軸台 (右)	1
49	#06	400-43924	L-HOOK_SHAFT_BASE-R-TRIM	大釜糸切り釜軸台 (右)	1
50	#08	401-53313	LOWER_SHAFT_GEAR_MM	下軸ギヤ (半半良品)	2
51	#08	SM-6052002-TP	SCREW M5 L=20	六角穴ボルト M5 X 0.8 L=20	2
		NOTE(注記)	#01....FOR LH-3528A,3568A (EXCEPT CHINA)	LH-3528A,3568A 用 (中国を除く)	
			#02....FOR LH-3528A-7,3568A-7 (EXCEPT CHINA)	LH-3528A-7,3568A-7 用 (中国を除く)	
			#03....FOR LH-3528A,3568A(CHINA)	LH-3528A,3568A 用 (中国)	
			#04....FOR LH-3528A-7,3568A-7(CHINA)	LH-3528A-7,3568A-7 用 (中国)	
			#05....FOR LH-3578A,3588A	LH-3578A,3588A 用	
			#06....FOR LH-3578A-7,3588A-7	LH-3578A-7,3588A-7 用	
			#07....FOR LH-3528A,LH-3528A-7, LH-3568A,LH-3568A-7	LH-3528A,LH-3528A-7,LH-3568A,LH-3568A-7 用	
			#08....FOR LH-3578A,LH-3578A-7, LH-3588A,LH-3588A-7	LH-3578A,LH-3578A-7,LH-3588A,LH-3588A-7 用	

11. FEED MECHANISM COMPONENTS

送り関係

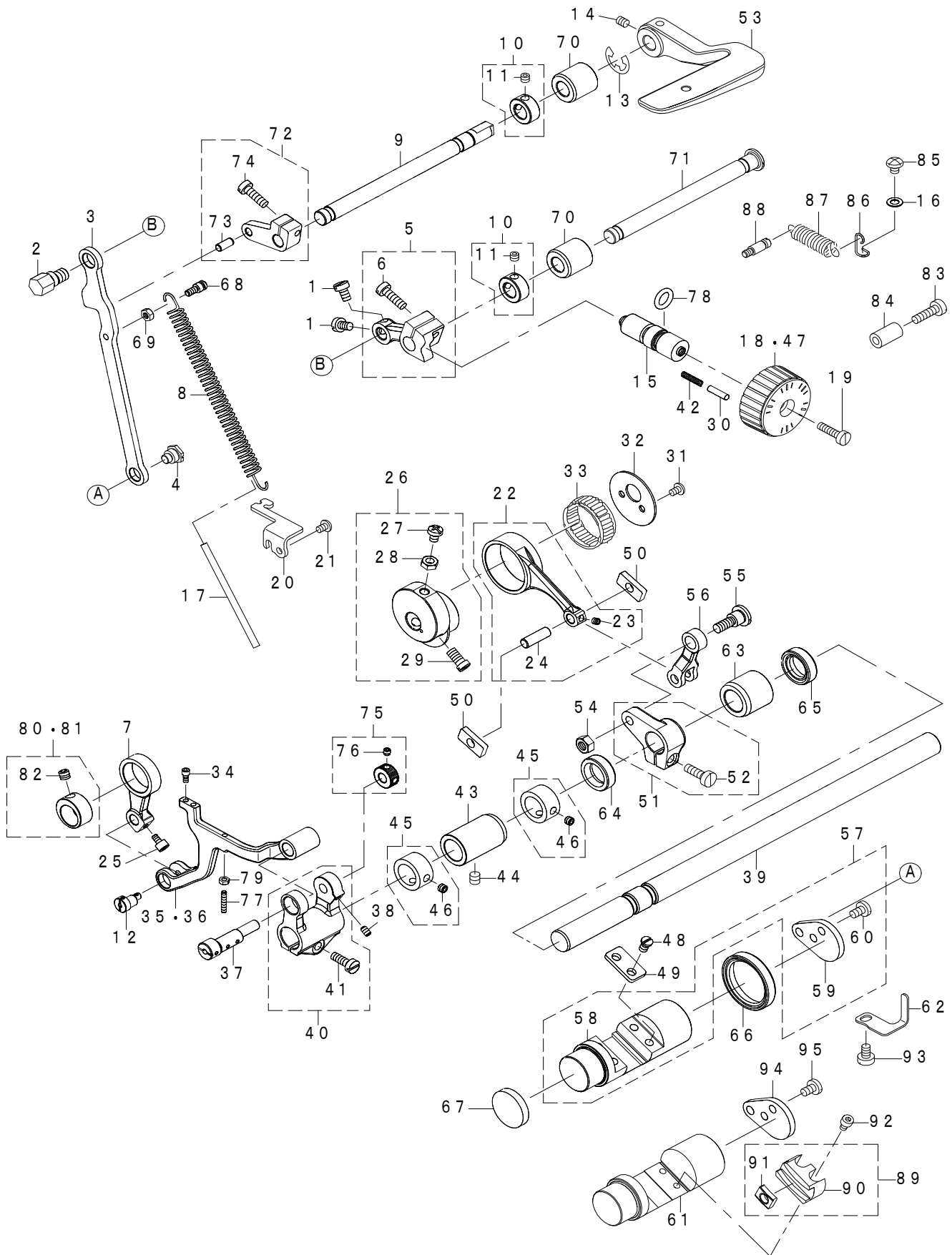

REF.NO	NOTE	PART NO	DESCRIPTION	品名	Qty
1		SM-6050800-SP	SCREW M5 L=8	平ねじ M5 L=8	2
2		400-28293	FEED_REGULATOR_ROD_PIN	送り調節ロッドピン	1
3		400-28284	FEED_REGULATOR_ROD	送り調節ロッド	1
4		SD-0900426-TP	SHOULDER SCREW D=9 H=4.2	段ねじ D=9 H=4.2	1
5		400-28854	ASSY_FEED_REGULATOR	送り調節台組	1
6		SM-6051600-SP	SCREW M5 L=16	平ねじ M5 L=16	(1)
7		400-11935	VERTICAL_FEED_LINK	上下送りリンク	1
8		400-25315	FEED_ADJUST_SPRING	送り調節ばね	1
9		400-28286	REVERSE_FEED_SHAFT	逆送りレバー軸	1
10		400-32269	THRUST COLLAR	スラストカラー	1
11		SM-80506A2-TP	SCREW M5 L=6	六角穴付き止めねじ M5 L=6	(2)
12		400-26673	VERTICAL_F_LINK_SHAFT_M	上下送りリンク軸M	1
13	#02	RE-0900000-K0	E-RING 9	E形止め輪 9	1
14	#01	SM-80506A2-TP	SCREW M5 L=6	六角穴付き止めねじ M5 L=6	1
15		229-11804	FEED REGULATOR SCREW	送り調節ねじ	1
16		WP-0520656-SA	WASHER 5.2X9.5X0.6	平座金 5.2X9.5X0.6	1
17		BP-3000001-0R	VINYL PIPE	ビニールパイプ	0.09
18		400-36433	FEED_DIAL	送りダイヤル	1
19		SS-6121860-SP	SCREW 3/16-28 L=18	平ねじ 3/16-28 L=18	1
20	#01	400-91188	SPRING_BRACKET	ばね掛け	1
21		SM-4040655-SP	SCREW M4 L=6	なべ小ねじ M4 L=6	2
22		400-32293	ASSY_FEED_ROCKER_ROD	水平送りロッド組	(1)
23		SM-8040412-TP	SET SCREW M4 L=4	止めねじ	(1)
24		B1653-470-000	PIN	角駒ピン	(1)
25		SM-6750690-TP	SCREW M3.5 L=6	六角穴ボルト M3.5 L=6	1
26		400-31348	ASSY_FD_ECCENTRIC_CAM	水平送りカム(組)	1
27		SM-4051255-SP	SCREW M5 L=12	なべねじ M5 L=12	(1)
28		NM-6050001-SP	NUT M5	六角ナット M5X0.8 1種	(1)
29		SM-80608A2-TP	SCREW M6 L=8	六角穴付き止めねじ M6 L=8	(2)
30		400-91190	FEED_ADJUSTING_PIN	送り調節ピン	1
31		SM-4040855-SP	SCREW	なべねじ	2
32		400-11906	FD_CAM_LID	水平送りカム蓋	1
33		B1636-681-B00	NEEDLE BEARING B	ニードルベアリング B	1
34		SM-6030672-TP	SCREW M3 L=6	六角穴ボルト M3 L=6	2
35	#01	400-11946	FEED_BASE	送り台(糸切り無し)	1
36	#02	400-11934	FEED_BASE_TRIM	送り台(糸切り)	1
37		400-11932	FEED_BASE_SHAFT	送り台軸	1
38		SM-8040612-TP	SCREW M4 L=6	止めねじ M4 L=6	1
39		400-28279	FEED_ROCKER_SHAFT	水平送り軸	1
40		400-31349	ASSY_FEED_BASE_ARM	送り台腕(組)	1
41		SM-6051400-SP	SCREW	平ねじ	(1)
42		229-12109	FEED_REGULATOR_PIN_SPRING	送り調節ピンばね	1
43		400-11939	FEED_SHAFT_BUSH_F	水平送り軸前メタル	1
44		SM-80608A2-TP	SCREW M6 L=8	六角穴付き止めねじ M6 L=8	1
45		400-32268	THRUST COLLAR	スラストカラー	2
46		SM-8050412-TP	SCREW M5 L=4	止めねじ M5 L=4	(2)
47	#03	400-50584	FEED DIAL 4	送りダイヤル4	1
48	#04	SM-7050850-TP	SCREW M5 L=8	丸平小ねじ M5 L=8	4
49	#04	400-28277	FEED_ADJUSTING_PLATE	送り調節体蓋	2
50	#04	400-35704	FEED_ADJUSTING_BLOCK	送り調節体角駒	2
51		400-28852	ASSY_FEED_ROCKER_ARM	水平送り腕組	1
52		SM-6051600-SP	SCREW M5 L=16	平ねじ M5 L=16	(1)
53		400-91189	REVERSE_FEED_LEVER	逆送りレバー	1
54		NM-6060001-CP	NUT M6	六角ナット M6	1
55		SD-0900706-TP	SHOULDER SCREW D=9 H=7	段ねじ D=9 H=7	1
56		400-36679	FEED_ROCKER_ARM_ROD	水平送り連結棒	1
57	#04	400-28274	ASSY_FEED_ADJUSTING	送り調節体組	1
58	#04	400-67594	FEED_ADJUSTING	送り調節体	(1)
59		400-28276	FEED_ADJUSTING_ARM	送り調節体腕	(1)
60		SM-7050850-TP	SCREW M5 L=8	丸平小ねじ M5 L=8	(2)
61	#05	400-94318	SLIDER BASE ARC	円弧スライダース台	1
62		400-91187	FEED_ADJUSTING_STOPPER	送り調節体受け板	1
63		400-28280	FEED_SHAFT_BUSH_R	水平送り軸後ろメタル	1
64		400-13362	FEED_SHAFT_OIL_SEAL_A	水平送り軸オイルシール	1
65		400-25316	FEED_SHAFT_OIL_SEAL_B	送り軸オイルシールB	1
66		400-28291	FEED_ADJUSTING_OIL_SEAL	調節体オイルシール	1
67		400-28294	FEED_ADJUSTING_CAP	送り調節体キャップ	1
68		400-11926	SPRING_HOOK	ばね掛け	1
69		NM-6040001-SP	NUT M4X0.7	六角ナット M4X0.7 1種	1
70		400-28287	REVERSE_FEED_SHAFT_BUSH	逆送りレバー軸メタル	2
71		401-09091	FEED_REGULATOR_SHAFT	送り調節軸	1
72		400-28855	ASSY_REVERSE_FEED_ARM	逆送りレバー腕組	1
73		133-19405	MAIN FEED ROCKER PIN	逆送りレバー腕ピン	(1)
74		SM-6051600-SP	SCREW M5 L=16	平ねじ M5 L=16	(1)
75		400-31350	ASSY_FEED_BASE_SAHFT_COLLAR	送り台軸スラスト受(組)	1
76		SM-8040412-TP	SET SCREW M4 L=4	止めねじ	(2)
77		SM-8031612-TP	SET SCREW M3X16	止めねじ	1
78		RO-0922702-00	RUBBER RING	Oリング	1
79		NM-6030001-SN	NUT	六角ナット	1
80	#04	400-33668	ASSY_VERTICAL_FEED_CAM	上下送りカム組	1
81	#05	400-95142	ASSY_VERTICAL_FEED_CAM_ARC	上下送りカム組(円弧)	1
82		SM-8060552-TP	SCREW M6 L=5	止めねじ	(1)
83		SM-6051850-TP	SCREW M5 L=18	平小ねじ M5 L=18	1
84		229-52501	BACK LEVER STOPPER	バックレバーストッパー	1
85		SM-4050655-SP	SCREW M5 L=6	なべ小ねじ M5 L=6	1
86		226-56003	SPRING SUSPENSION	レバーばね掛け	1
87		400-40924	SPRING	送りレバー戻しばね	1
88		400-40963	TENSION_SPRING_RACK_B	引張りばね掛け B	1
89	#05	400-96206	ASSY_SLIFER_ARC	円弧スライダ(組)	2
90		400-94315	SLIDER ARC	円弧スライダ	(1)
91		400-94316	FEED ADJUSTING BLOCK ARC	送り調節体角駒(円弧)	(1)
92		SM-6041002-TP	SCREW M4X0.7 L=10	六角穴ボルト M4X0.7 L=10	4
93		SM-6050800-SP	SCREW M5 L=8	平ねじ M5 L=8	1
94	#05	400-28276	FEED_ADJUSTING_ARM	送り調節体腕	1
95	#05	SM-7050850-TP	SCREW M5 L=8	丸平小ねじ M5 L=8	2
		NOTE(注記)	#01...FOR LH-3528A,3568A,3578A,3588A #02...FOR LH-3528A-7,3568A-7,3578A-7,3588A-7 #03...FOR LH-3528A-0B, LH-3528A(TYPE F) #04...TYPE S #05...TYPE G	LH-3528A,3568A,3578A,3588A 用 LH-3528A-7,3568A-7,3578A-7,3588A-7 用 LH-3528A-0B,LH-3528A 用(F仕様) S仕様 G仕様	

12. PRESSER BAR & TENSION RELEASE COMPONENTS

押さえ棒・糸ゆるめ関係

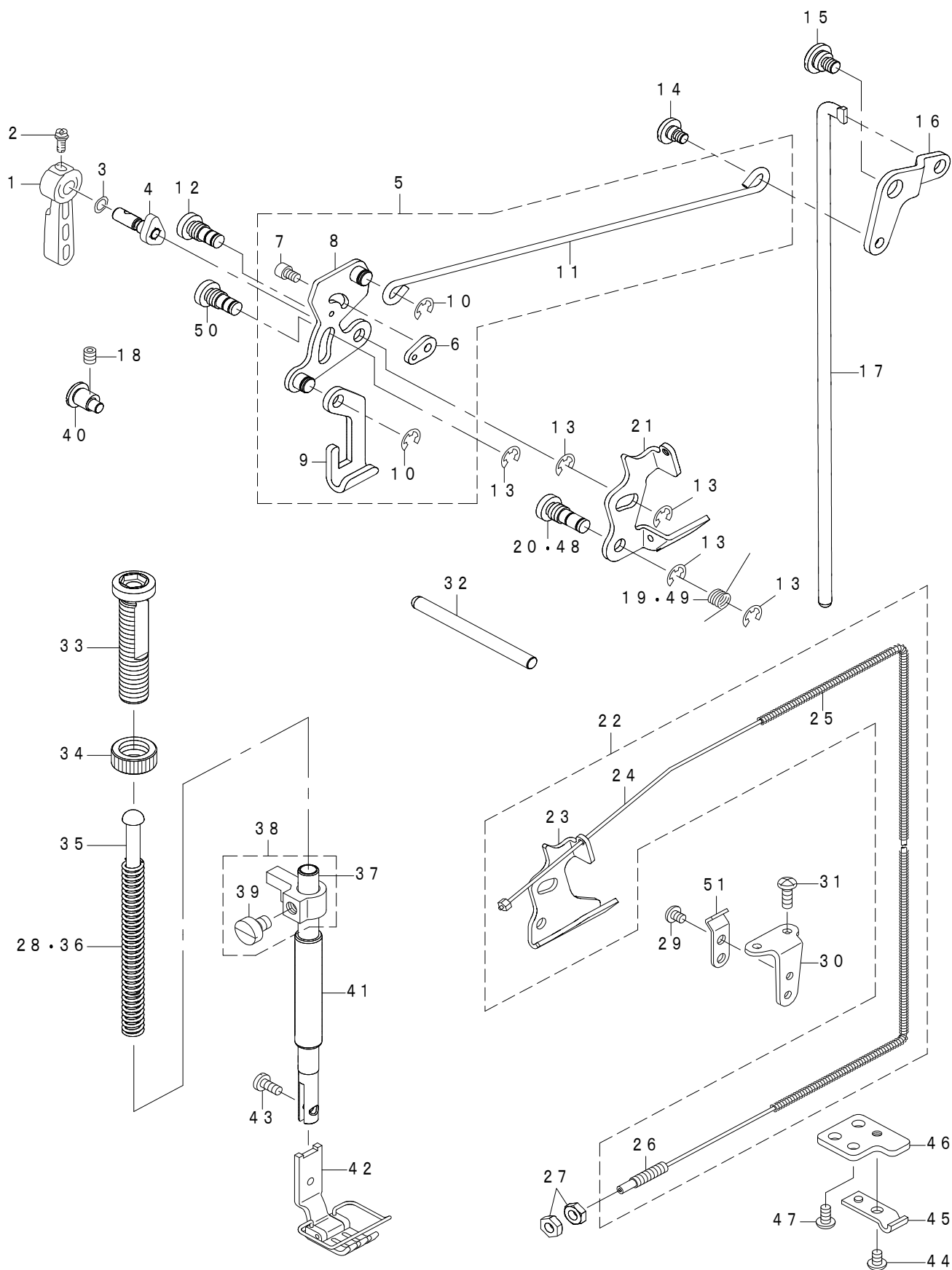

REF.NO	NOTE	PART NO	DESCRIPTION	品名	Qty
1		229-07802	HAND LIFTER	押え上げレバー	1
2		B1521-555-000	SCREW	押え上げレバー止めねじ	1
3		RO-0371801-00	RUBBER RING	Oリング	1
4		400-35394	HAND_LIFTER_CAM_ASM.	押え上げカム組	1
5		400-57398	ASSY LIFTING CONNECT ROD	膝上げ引き上げ横棒組	1
6		236-09605	PLATE	糸緩め切換板	(1)
7		SM-6040602-TP	SCREW M4 L=6	六角穴ボルト M4X0.7 L=6	(1)
8		400-51384	ASSY HAND LIFTER LINK	引き上げリンク組	(1)
9		229-08008	LIFTING PLATE	引き上げ板	(1)
10		RE-0500000-K0	E-RING	E形止め輪 5	(2)
11		400-35151	LIFTING_CONNECTING_ROD	膝上げ横棒	(1)
12		400-28545	LINK_SHAFT	引き上げリンク軸	1
13		RE-0500000-K0	E-RING	E形止め輪 5	5
14		SD-0640357-TP	SHOULDER SCREW	段ねじ D=6.35 H=3.5	1
15		SD-0900356-TP	SHOULDER SCREW D=9 H=3.5	段ねじ D=9 H=3.5	1
16		400-35181	LIFTING_LEVER_LINK	膝上げリンク	1
17		400-28268	CONNECTING_ROD_A	膝上げ連結棒	1
18		SM-8050812-TP	SCREW M5X8	止めねじ M5X0.8 L=8	1
19		400-53231	RETURN_SPRING	糸緩め板戻しばね	1
20		400-28546	TENSION_RELEASE_SHAFT	糸緩め板軸	1
21	#01	400-35298	TENSION_RELEASE_PLATE	糸緩め板	1
22	#02	400-35828	ASSY_TENSION_RELEASE_PLATE	糸緩め板組	1
23		400-84941	TENSION_RELEASE_PLATE	糸緩め板	(1)
24		400-33434	THREAD_TENSION_RELEASE_WIRE	ワイヤーケーブル結合	(1)
25		400-33435	WIRE_TUBE	ワイヤーチューブ	(1)
26		D3159-555-B00	SET SCREW	ワイヤーセットねじ	(1)
27	#02	NS-6620310-SP	NUT 3/16-32	六角ナット 3/16-32	2
28	#05	229-07406	PRESSER SPRING	押え調節ばね	1
29	#02	SS-4110715-SP	SCREW 11/64-40 L=7	なべねじ 11/64-40 L=7	2
30	#02	402-55442	FLEXIBLE TUBE SUPPORT PLATE	フレキシブル取付台	1
31	#02	SS-4111215-SP	SCREW 11/64-40 L=12	なべねじ 11/64-40 L=12	2
32		400-84419	PUSH_BAR	押し棒	1
33		236-09209	PRESSER SPRING REGULATOR	押え調節ねじ	1
34		229-07604	PRESSER SPRING REGULATOR NUT	押え調節ねじナット	1
35		229-07703	PRESSER GUIDE BAR	押え案内棒	1
36	#04	B1505-227-T00-A	PRESSER SPRING	押え調節ばね	1
37		400-28547	PRESSER BAR	押え棒	1
38		400-32272	ASSY_PRESSER_BAR HOLDER	押え棒抱き組	1
39		SM-6060800-SP	SCREW M6 L=8	平ねじ M6 L=8	(1)
40		400-28269	LIFTER_ADJUSTING_PIN	微量押え上げ調節ピン	1
41		236-09001	BUSHING	押え棒メタル	1
42	#03	226-40551	PRESSER FOOT ASM.	先割れ縦押え(組) 1/4 (6.4)	1
43		SS-7090910-TP	SCREW 9/64-40 L=8.5	丸平ねじ 9/64-40 L=8.5	1
44	#02	SM-4040655-SP	SCREW M4 L=6	なべ小ねじ M4 L=6	1
45	#02	D3164-555-B00	OUTER PRESSER PLATE	アウター押え	1
46	#02	400-50314	OUTER HOLDER_BASE	アウター押え土台	1
47	#02	SM-4040855-SP	SCREW	なべねじ	1
48	#02	400-85773	TENSION_RELEASE_SHAFT	糸緩め板軸	1
49	#02	400-85717	RETURN_SPRING	糸緩め板戻しばね	1
50		401-02831	LINK_SHAFT	引上げリンク軸	1
51	#02	229-44508	WIRE PRESSER A	ワイヤーオサエA	1
		NOTE(注記)	#01....FOR LH-3528A,3568A,3578A,3588A #02....FOR LH-3528A-7,3568A-7, 3578A-7,3588A-7 #03....EXCHANGING GAUGE PARTS #04....TYPE A #05....EXCEPT TYPE A	LH-3528A,3568A,3578A,3588A用 LH-3528A-7,3568A-7,3578A-7,3588A-7用 交換ゲージ部品 A仕様 A仕様を除く	

13. THREAD TRIMMER MECHANISM COMPONENTS (FOR LH-3528A-7,3568A-7,3578A-7,3588A-7)

糸切り装置関係 (LH-3528A-7,3568A-7,3578A-7,3588A-7 用)

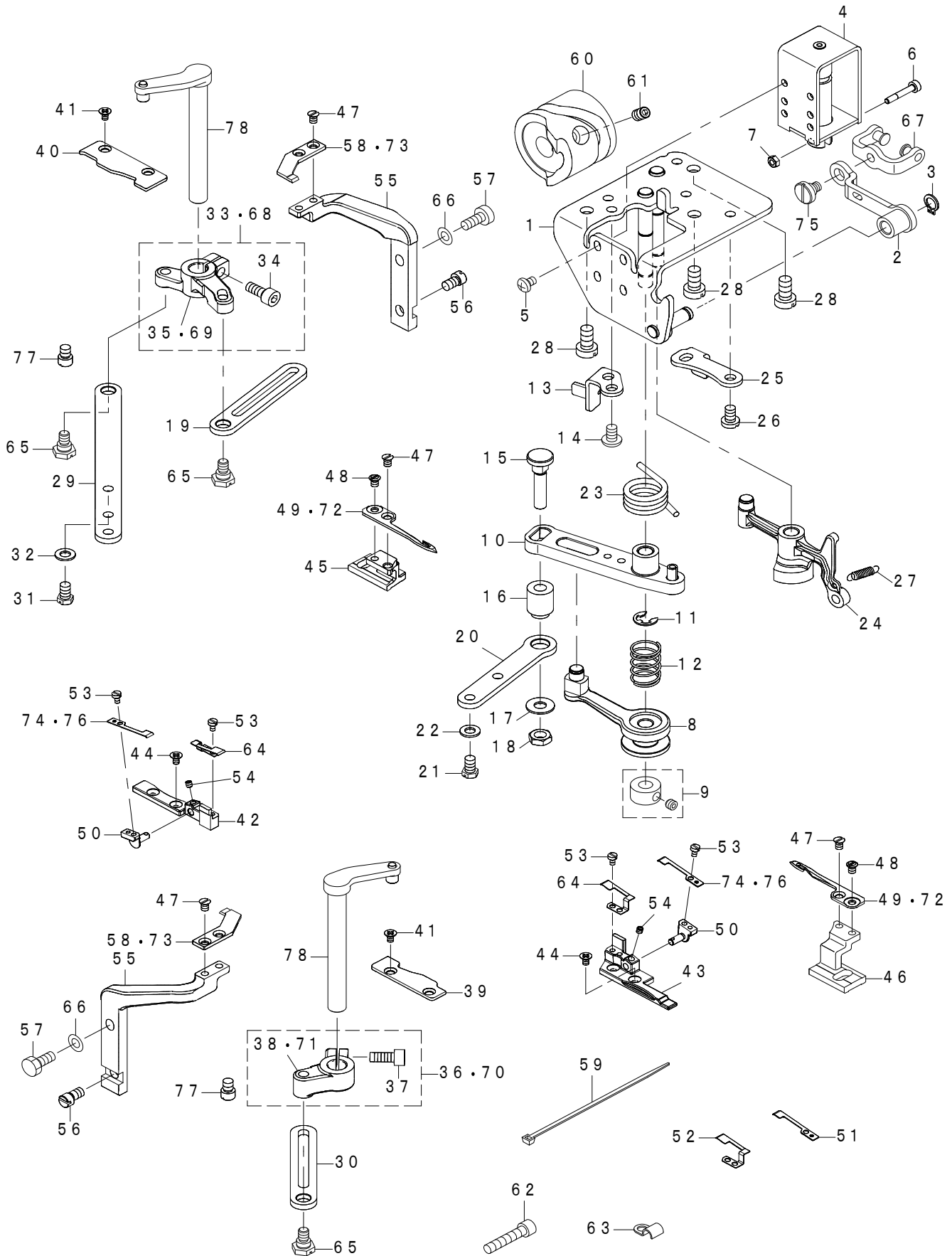

REF.NO	NOTE	PART NO	DESCRIPTION	品 名	Qty	
1		400-66128	ASSY_BASE_PLATE	ベース板組	1	
2		400-65721	ASSY_SUB_TRM_PUSH_LINK	糸切り押しリンク組	1	
3		RC-0650811-KP	RETAINING RING	C形止め輪	1	
4		401-08582	THREAD_TRIMMER_SOLENOID	糸切りソレノイド	1	
5		SM-4040601-SC	SCREW M4X0.7 L=6	なべ小ねじ M4X0.7 L=6	4	
6		235-42418	CLUTCH LINK PIN	クラッチリンクピン	1	
7		NM-6030001-SC	NUT M3	六角ナット M3X0.5 1種	2	
8		400-17399	ASSY_TRM_ROLLER_ARM	カムローラ腕組	1	
9		400-10434	THRUST_COLLAR_ASM.	天秤クランクピンスラストカラー組	1	
10		229-48558	KNIFE DRIVING ARM ASM.	メス駆動腕組	1	
11		RE-0600000-K0	E-RING 6	E形止め輪 6	1	
12		400-17400	ROLLER_ARM_SPRING	ココ腕ばね	1	
13		400-17361	TRM_DRIVING_ARM_STOPPER	糸切り駆動腕ストッパー	1	
14		SM-4050855-SP	SCREW	なべねじ M5 L=8	2	
15		400-17401	TRM_DRIVING_LINK_PIN	動メスリンクピン	1	
16		400-17402	TRM_DRIVING_LINK_BUSH	動メスリンクブッシュ	1	
17		WP-0621046-SP	WASHER	平座金	1	
18		NM-6060003-SC	NUT M6	六角ナット M6	1	
19		400-12505	CONNECTING_ROD_B	コネクティングロッドB	1	
20		400-12506	CONNECTING_ROD_C	コネクティングロッドC	1	
21		SM-9050850-SP	SCREW	六角ボルト	2	
22		WP-0531000-SD	WASHER M5	平座金小形丸 M5	2	
23		400-17403	TRM_DRIVING_ARM_SPRING	糸切り駆動戻しばね	1	
24		400-15669	ASSY_THREAD_RELEASE_ARM	アッシースレッドリリースアーム	1	
25		400-17362	RELEASE_ARM_STOPPER	糸緩め駆動腕ストッパー	1	
26		SM-4050855-SP	SCREW	なべねじ M5 L=8	2	
27		113-05901	SPRING	糸緩め差動板ばね	1	
28		SM-6061200-SP	SCREW	平ねじ M6 L=12	3	
29		400-12504	CONNECTING_ROD_A	コネクティングロッドA	1	
30		400-12505	CONNECTING_ROD_B	コネクティングロッドB	1	
31		SM-9050850-SP	SCREW	六角ボルト	2	
32		WP-0531000-SD	WASHER M5	平座金小形丸 M5	2	
33	#02	400-31352	ASSY_KNIFE_DRIVING_ARM_R	動メス駆動腕(右)組	1	
34		SM-6051202-TP	SCREW M5X0.8 L=12	六角穴ボルト M5X0.8 L=12	(1)	
35	#02	400-14844	KNIFE_DRIVING_ARM_R	糸切りメス駆動腕R	(1)	
36	#02	400-36446	ASSY_KNIFE_DRIVING_ARM_L	動メス駆動腕(左)組	1	
37		SM-6051202-TP	SCREW M5X0.8 L=12	六角穴ボルト M5X0.8 L=12	(1)	
38	#02	400-33337	KNIFE_DRIVING_ARM_L	糸切りメス駆動腕L	(1)	
39		400-12492	D_KNIFE_BASE_GUIDE_L	動メス土台ガイド左	1	
40		400-21883	D_KNIFE_BASE_GUIDE_R	動メス土台ガイド右	1	
41		SM-1030601-SN	SCREW M3X0.5 L=6	皿小ねじ M3X0.5 L=6	4	
42		400-21899	D_KNIFE_SUPPORT_R	動メス支え右	1	
43		400-21898	D_KNIFE_SUPPORT_L	動メス支え左	1	
44		SM-1030601-SN	SCREW M3X0.5 L=6	皿小ねじ M3X0.5 L=6	4	
45		400-12488	DRIVING_KNIFE_BASE_R	ドライビングナイフベースR	1	
46		400-12487	DRIVING_KNIFE_BASE_L	ドライビングナイフベースL	1	
47		SS-1090520-TP	SCREW 9/64-40 L=5	皿小ねじ 9/64-40 L=5	6	
48		SS-6090580-TP	SCREW 9/64-40 L=4.5	平小ねじ 9/64-40 L=4.5	2	
49	★	#05	401-09415	DRIVING_KNIFE	動メス本糸	2
50		400-12495	CLAMP_SPRING_BASE	クランプスプリングベース	2	
51	★	#01	400-33160	CLAMP_SPRING	クランプばね	2
52	★	#01	400-44393	CLAMP	クランプ板	2
53		SM-6850400-SP	SCREW M2.5 L=4	平小ねじ M2.5 L=4	6	
54		SM-8030312-TP	SCREW M3 L=3	止めねじ M3 L=3	2	
55		400-12489	FIXED_KNIFE_BASE	固定メス土台	2	
56		400-12496	FIXED_KNIFE_BASE_ADJUST	固定メス土台調整ねじ	2	
57		SM-9051203-CP	SCREW M5 L=12	六角ボルト M5 L=12	2	
58	★	#05	400-12404	FIXED_KNIFE	固定メス	2
59		EA-9500B01-00	CABLE BAND	束線バンド	5	
60		400-13316	THREAD_TRIMMER_CAM	糸切りカム	1	
61		SM-80608A2-TP	SCREW M6 L=8	六角穴付き止めねじ M6 L=8	2	
62		SM-6052502-TP	SCREW M5X0.8 L=25	六角穴ボルト	1	
63		EA-9500B01-00	CABLE BAND	束線バンド	1	
64	★	#05	400-76709	CLAMP	クランプ板	2
65		SD-0700346-TP	SHOULDER SCREW D=7 H=3.4	段ねじ D=7 H=3.4	3	
66		WP-0531000-SD	WASHER M5	平座金小形丸 M5	2	
67		400-65722	ASSY_TRM_PUSH_LINK	糸切り押しリンク	1	
68	#03	400-72896	ASSY_KNIFE_DRIVING_ARM_R	糸切りメス駆動腕R(組)	1	
69	#03	400-21726	KNIFE_DRIVING_ARM_R_LH	メス駆動腕R	(1)	
70	#03	400-26909	ASSY_KNIFE_DRIVING_ARM_L	糸切りメス駆動腕L(組)	1	
71	#03	400-12500	KNIFE_DRIVING_ARM_L	メス駆動腕L	(1)	
72	★	#04	400-98762	DRIVING_KNIFE	動メス	2
73	★	#04	400-98763	FIXED_KNIFE	固定メス	2
74	★	#04	400-98764	CLAMP	クランプ	2
75		SD-0700336-TP	SHOULDER SCREW	段ねじ D=7 H=3.25	1	
76	★	#05	400-76708	CLAMP_SPRING	クランプばね	2
77		400-12503	KNIFE_DRIVING_ARM_PIN	ナイフドライビングアームピン	2	
78		400-12497	ASSY_KNIFE_BASE_SHAFT	アッシーナイフベースシャフト	2	
		NOTE(注記)	#01....OPTIONAL PARTS #02....FOR LH-3528A-7,3568A-7 #03....FOR LH-3578A-7,3588A-7 #04....TYPE G #05....EXCEPT TYPE G	オプション部品 LH-3528A-7,3568A-7用 LH-3578A-7,3588A-7用 G仕様 G仕様を除く		

14. AUTOMATIC REVERSE FEED MECHANISM COMPONENTS

自動逆送り関係

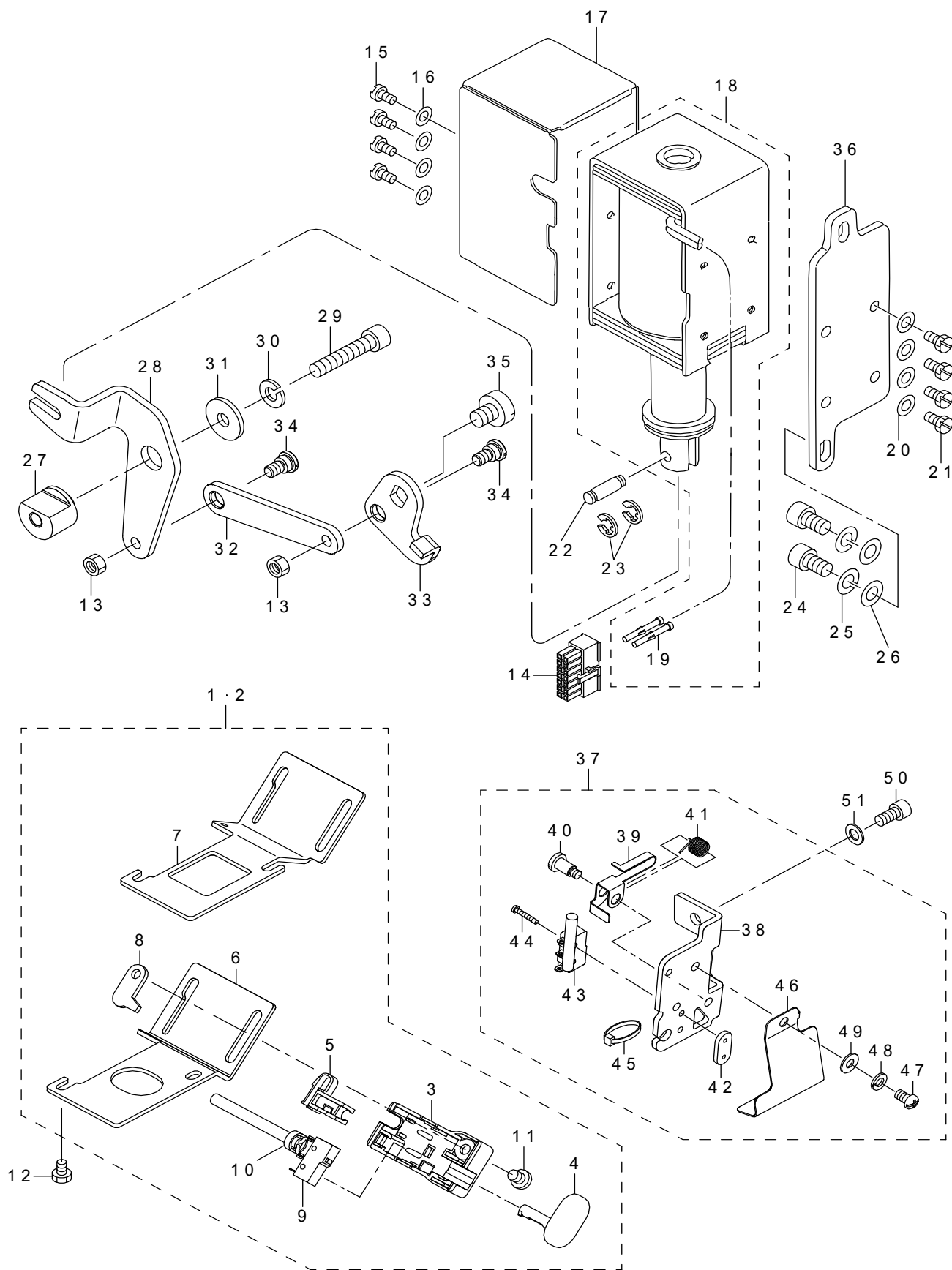

REF.NO	NOTE	PART NO	DESCRIPTION	品名	Qty
1	#01	400-91208	ASSY_RVS_FEED_SWITCH_A	逆送りスイッチA (組)	1
2	#02	400-91209	ASSY_RVS_FEED_SWITCH_B	逆送りスイッチB (組)	1
3		236-31708	REVERSE FEED SWITCH COVER	逆送りスイッチカバー	(1)
4		236-31807	REVERSE FEED SWITCH SHAFT	逆送りスイッチ軸	(1)
5		236-31906	REVERSE FEED SWITCH SUPPORT	逆送りスイッチ受	(1)
6	#01	400-91257	RVS_FEED_SWITCH_BASE_A	逆送りスイッチ台A (片針無)	(1)
7	#02	400-91256	RVS_FEED_SWITCH_BASE_B	逆送りスイッチ台B (片針付)	(1)
8		236-32102	REVERSE FEED SWITCH BASE GUIDE	逆送りスイッチ台ガイド	(1)
9		400-93523	REVERSE FEED CORD ASM.	逆送りコード (組)	(1)
10		EA-9500B01-00	CABLE BAND	束線バンド	(1)
11		SS-7110740-TP	SCREW 11/64-40 L=7	丸平ねじ 11/64-40 L=7	(1)
12		SM-9040603-SC	SCREW M4 L=6	六角ボルト M4X0.7 L=6	2
13		NM-6050001-SP	NUT M5	六角ナット M5X0.8 1種	2
14		HK-0346101-40	HOUSING 14P	ハウジング 14P	1
15		SS-7110710-SP	SCREW 11/64-40 L=7	丸平ねじ 11/64-40 L=7	4
16		WP-0501016-SD	WASHER 5X10.5X1	平座金 5X10.5X1	4
17		400-91211	MAGBET_COVER	マグネットカバー	1
18		400-36360	REVERSE_FEED_SOLENOID	逆送りソレノイド	1
19		HK-0346400-0B	PIN CONTACT	ピンコンタクト	(2)
20		WP-0501016-SD	WASHER 5X10.5X1	平座金 5X10.5X1	4
21		SS-9111010-SP	SCREW 11/64-40 L=9.5	六角ボルト 11/64-40 L=9.5	4
22		D2464-555-B00	LINK DRIVING MAGNET PIN	マグネットリンクピン	1
23		RE-0400000-K0	E-RING 4	E形止め輪 4	2
24		SM-6061202-TP	SCREW M6 L=12	六角穴ボルト M6 L=12	2
25		WS-0631510-KP	SPRING WASHER	ばね座金	2
26		WP-0621016-SD	WASHER 6.2X13X1	平座金 6.2X13X1	2
27		400-30856	LINK_FULCULUM	リンク支点	1
28		401-00131	REVERSE_FEED_LINK_L	逆送りリンク	1
29		SM-6063002-TP	SCREW M6 L=30	搬送体軸受け止めねじ	1
30		WS-0610002-KP	SPRING WASHER	ばね座金	1
31		WP-0600816-SP	WASHER	平座金	1
32		400-35278	REVERSE_FEED_LINK_B	逆送りリンク_B	1
33		400-35277	REVERSE_FEED_LINK_A	逆送りリンク_A	1
34		SD-0700328-TP	SHOULDER SCREW D=7 H=3.2	段ねじ D=7 H=3.2	2
35		SM-6050650-TP	SCREW M5 L=6	平小ねじ M5 L=6	1
36		101-19204	SOLENOID INSTALLING PLATE	マグネット取付け台	1
37		400-91210	ASSY_SAFETY_SWITCH	安全スイッチ (組)	1
38		400-91246	SAFETY_SWITCH_BASE	安全スイッチ台	(1)
39		236-38109	SAFETY_SWITCH_ARM	安全スイッチ腕	(1)
40		236-38307	SAFETY_SWITCH_ARM_SHAFT	安全スイッチ腕支点軸	(1)
41		236-38208	SAFETY_SWITCH_SPRING	安全スイッチ戻しばね	(1)
42		236-38406	SAFETY_SWITCH_NUT	安全スイッチ止め板	(1)
43		400-98612	SAFETY_SWITCH_CORD_ASM.	安全スイッチコード (組)	(1)
44		SM-4021201-SC	SCREW M2 L=12	なべ小ねじ M2 L=12	(2)
45		EA-9500B01-00	CABLE BAND	束線バンド	(1)
46		400-91286	SAFETY_SWITCH_COVER	安全スイッチカバー	(1)
47		SS-4110515-SP	SCREW 11/64-40 L=5	なべねじ 11/64-40 L=5	(1)
48		WS-0451040-KP	SPRING WASHER 4.5X8.5X1	ばね座金 4.5X8.5X1	(1)
49		WP-0450801-SP	WASHER	平座金	(1)
50		SM-6051002-TP	SCREW M5X0.8 L=10	六角穴ボルト M5X0.8 L=10	1
51		WP-0550800-SP	WASHER 5.5X10X0.8	平座金 5.5X10X0.8	1
		NOTE(注記)	#01....FOR LH-3528A-7,3578A-7 #02....FOR LH-3568A-7,3588A-7	LH-3528A-7,3578A-7 用 LH-3568A-7,3588A-7 用	

15. WIPER MECHANISM COMPONENTS (FOR LH-3528A-7,3568A-7,3578A-7,3588A-7)

ワイパー装置関係 (LH-3528A-7,3568A-7,3578A-7,3588A-7 用)

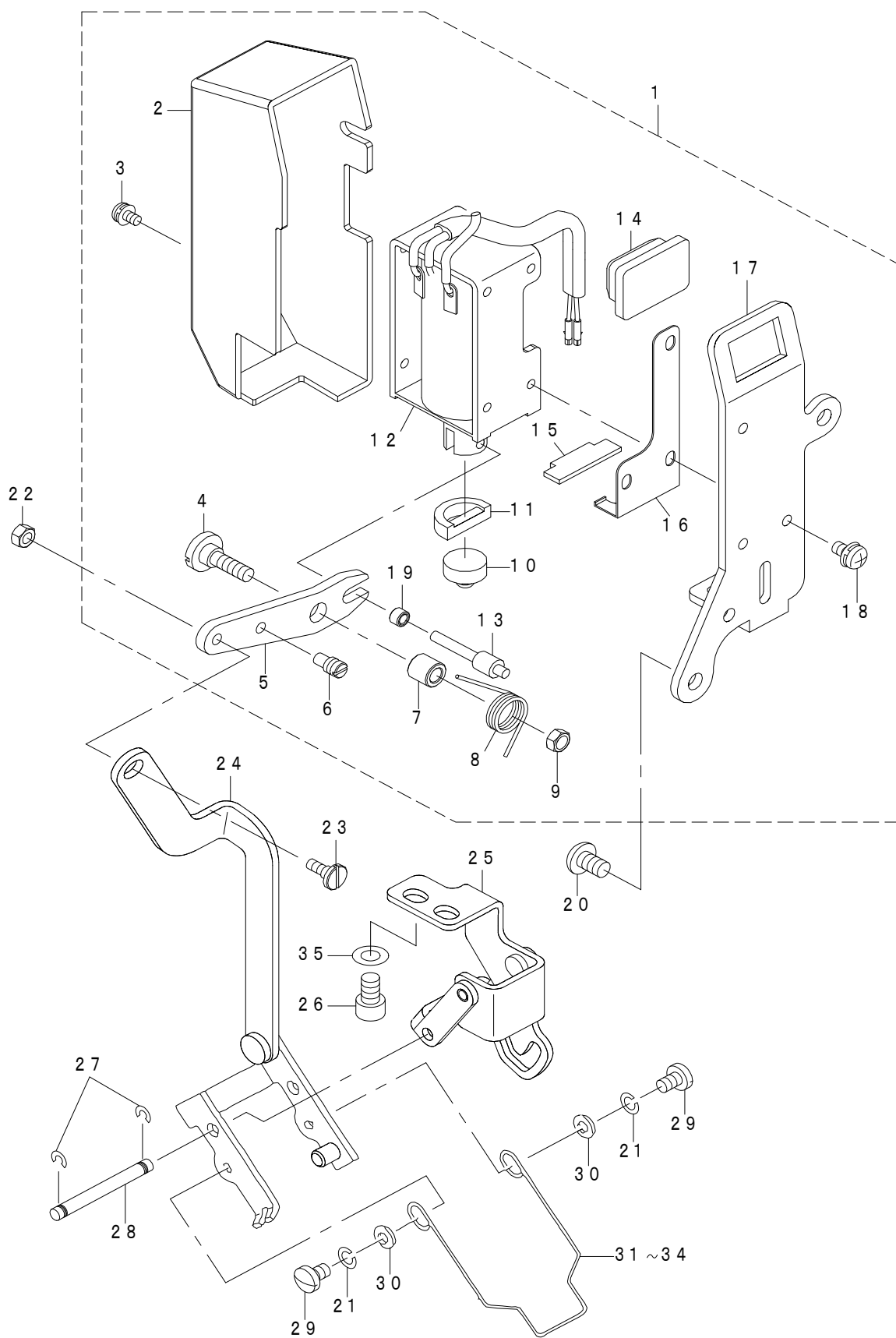

REF.NO	NOTE	PART NO	DESCRIPTION	品名	Qty
1		400-96975	WIPER_SOLENOID_ASM.	ワイパーソレノイド組	1
2		229-55504	WIPER COVER	ワイパーカバー	(1)
3		SL-4030631-SC	SCREW M3X6	座金付きなべ小ねじ M3 L=6	(1)
4		SD-0650321-TP	HINGE SCREW D=6.5 H=3.2	段ねじ D=6.5 H=3.2	(1)
5		226-57209	WIPER LINK A	ワイパーリンク A	(1)
6		400-09196	SUSPENSION SCREW	上糸切りばね掛け	(1)
7		229-56205	WIPER HINGE SCREW COLLAR	ワイパー段ねじカラー	(1)
8		226-57308	WIPER SPRING	ワイパーばね	(1)
9		NS-6110310-SP	NUT 11/64-40	六角ナット 11/64-40	(1)
10		229-55900	WIPER RUBBER A	ワイパーゴムA	(1)
11		229-56007	WIPER RUBBER B	ワイパーゴムB	(1)
12		402-11878	WIPER SOLENOID ASM.	ワイパーソレノイド組	(1)
13		229-57104	WIPER SOLENOID SHAFT	ワイパーソレノイド軸	(1)
14		400-86678	WIPER_SW_RUBBER	ワイパーSWキャップ	(1)
15		400-86679	WIPER_STOPPER_RUBBER	ワイパーストッパーゴム	(1)
16		401-00900	RUBBER HOLDER	ゴム支え板	(1)
17		400-42151	WIPER_SOLENOID_BASE	ワイパーソレノイドベース	(1)
18		SL-4030641-SE	SCREW	座金付きねじ	(3)
19		229-57203	WIPER LINK COLLAR	ワイパーリンクカラー	(1)
20		SM-4050855-SP	SCREW	なべねじ M5 L=8	2
21		WS-0410002-KP	SPRING WASHER	ばね座金 M4	2
22		NS-6090310-SP	NUT 9/64-40	六角ナット 9/64-40	1
23		SD-0500301-SP	HINGE SCREW D=5 H=3	段ねじ D=5 H=3	1
24		400-28797	ASSY_WIPER_LINK_2	ワイパーリンク組2	1
25		400-28799	ASSY_WIPER_BASE	ワイパー土台組	1
26		SM-6050802-TP	SCREW M5X0.8 L=8	六角穴ボルト M5X0.7 L=8	2
27		RC-0370411-KP	C-RING 4 (3.7)	C形止め輪 4 (3.7)	2
28		400-39824	WIPER_LINK_SHAFT	ワイパーリンク軸	1
29		SS-7090610-SP	SCREW 9/64-40 L=6	丸平ねじ 9/64-40 L=6	2
30		WP-0371016-SD	WASHER 3.7X8X1	平座金 3.7X8X1	2
31	#01	102-09203	WIPER	ワイパー	1
32	#01	102-09500	WIPER	ワイパー	1
33	#01	102-09807	WIPER	ワイパー	1
34	#01	102-09906	WIPER	ワイパー	1
35		WP-0531000-SD	WASHER M5	平座金小形丸 M5	2
		NOTE(注記)	#01....SELECTIVE PARTS	選択部品	

16. LUBRICATION COMPONENTS (FOR LH-3528A,3528A-7,3568A,3568A-7)

給油関係 (LH-3528A,3528A-7,3568A,3568A-7 用)

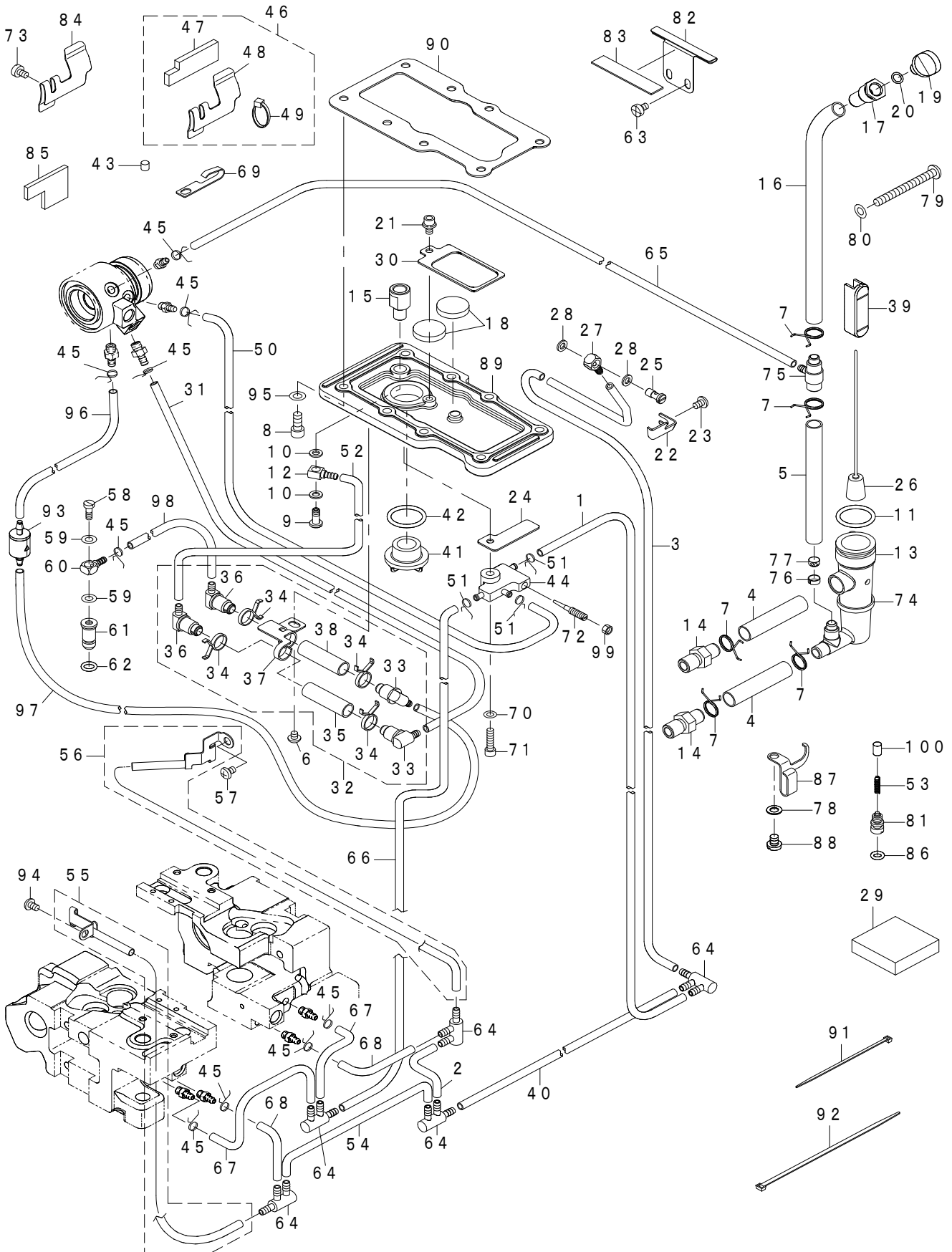

REF.NO	NOTE	PART NO	DESCRIPTION	品名	Qty
1		BP-3000001-0R	VINYL PIPE	ビニールパイプ	0.04
2		BP-3000001-0R	VINYL PIPE	ビニールパイプ	0.06
3		BP-3000001-0R	VINYL PIPE	ビニールパイプ	0.15
4		236-30106	TUBE B	チューブB	0.06
5		236-30106	TUBE B	チューブB	0.05
6		SM-40405C5-SP	SCREW	なべ小ねじ M4 L=5	1
7		236-29405	PIPE STOPPER B	パイプ止めB	7
8		SM-6051202-TP	SCREW M5X0.8 L=12	六角穴ボルト M5X0.8 L=12	8
9		B3525-357-000	CONNECTING SCREW (B)	L形連結ねじB	1
10		400-97210	GASKET	パッキン	2
11		RO-1952401-00	RUBBER RING	Oリング	1
12		SQ-0000401-MZ	CONNECTING SCREW	チューブ連結ねじ	1
13		401-60015	FLOATER_CASE	浮き子ケース	1
14		400-91202	CONNECTING_SCREW	パイプ連結ねじ	2
15		400-91200	BOX_COVER_JOINT	ボックスカバー継手	1
16		236-30106	TUBE B	チューブB	0.2
17		400-29075	LUBRICATING_INLET	給油口	1
18		B8228-125-000	OIL RESERVOIR MAGNET	磁石	2
19		400-91195	LUBRICATING_INLET_CAP	給油口キャップ	1
20		RO-0481901-00	RUBBER RING	Oリング	1
21		SM-4040655-SP	SCREW M4 L=6	なべ小ねじ M4 L=6	1
22		400-91205	TUBE HOLDER	チューブ押え	1
23		SM-4040655-SP	SCREW M4 L=6	なべ小ねじ M4 L=6	1
24		400-91203	TUBE HOLDER	パイプ押え	1
25		SQ-2060443-SD	CONNECTING SCREW	パイプ連結ねじ	1
26		400-91196	ASSY_FLOATER	フローター (組)	1
27		SQ-0000451-MZ	CONNECTING SCREW	パイプ連結ねじ	1
28		400-04749	GASKET	Cメタル給油ジョイントパッキン	2
29		400-91238	FILTER	フィルタ	1
30		400-91204	MAGNET HOLDER	マグネットホルダ	1
31		236-30007	TUBE	チューブ	0.04
32		401-60401	ASSY_OIL_FILTER	オイルフィルタ (組)	1
33		236-30601	OIL_FILTER_JOINT	オイルフィルタジョイント	(2)
34		236-29405	PIPE STOPPER B	パイプ止めB	(4)
35		236-30106	TUBE B	チューブB	(0.035)
36		236-30650	OIL_FILTER_JOINT_ASM.	オイルフィルタジョイント (組)	(2)
37		401-60332	FILTER HOLDER	フィルタホルダ	(1)
38		236-30106	TUBE B	チューブB	(0.035)
39		400-36167	OIL_GAGE	オイルゲージ	1
40		BP-3000001-0R	VINYL PIPE	ビニールパイプ	0.3
41		229-24708	OIL SIGHT WINDOW	油窓	1
42		RO-1952401-00	RUBBER RING	Oリング	1
43		B3517-009-000	OIL FELT REAR	後部油止めフェルト	1
44		400-32804	BASE	油分配器	1
45		236-29306	PIPE STOPPER A	パイプ止めA	10
46	* #01	403-00891	ASSY_LUBRICATING_GUIDE	面部給油ガイド組	1
47	*	403-00491	FELT	フェルト	(1)
48	*	232-04803	LUBRICATING GUIDE	面部給油ガイド	(1)
49	*	A4078-009-000	BAND (SMALL)	ソクセンバンド	(1)
50		236-30007	TUBE	チューブ	0.09
51		101-26803	OIL TUBE HOLDER	パイプ止め	3
52		236-30007	TUBE	チューブ	0.09
53		236-28902	PLUNGER SPRING	プランジャばね	2
54		BP-3000001-0R	VINYL PIPE	ビニールパイプ	0.09
55		400-32405	ASSY_GEAR_OIL_WICK_LEFT	ギヤ給油バイリン組左	1
56		400-32406	ASSY_GEAR_OIL_WICK_RIGHT	ギヤ給油バイリン組右	1
57		SM-4050655-SP	SCREW M5 L=6	なべ小ねじ M5 L=6	1
58		B3525-357-000	CONNECTING SCREW (B)	L形連結ねじ B	1
59		400-97210	GASKET	パッキン	2
60		SQ-0000401-MZ	CONNECTING SCREW	チューブ連結ねじ	1
61		400-36333	SUCTION	給油口	1
62		RO-0371801-00	RUBBER RING	Oリング	1
63		SM-6040650-TP	SCREW	平ねじ M4 L=6	2
64		236-29504	DISTRIBUTOR	分配器A	5
65		BP-3000001-0R	VINYL PIPE	ビニールパイプ	0.3
66		236-30007	TUBE	チューブ	0.31
67		236-30007	TUBE	チューブ	0.06
68		BP-3000001-0R	VINYL PIPE	ビニールパイプ	0.025
69		262-30409	LUBRICATING OIL WICK STOPPER	給油芯止め	1
70		WP-0430800-SD	WASHER M4	平座金小形丸 M4	1
71		SM-6041802-TP	SCREW M4 L=18	六角穴ボルト	1
72		B1834-512-000	OIL ADJUSTING SCREW	油量調節ねじ	1
73		SM-6040650-TP	SCREW	平ねじ M4 L=6	1
74		EA-9500B02-00	CABLE BAND 150	結束バンド 150	1
75		400-40809	OIL_JOINT	オイルジョイント	1
76		236-30502	OIL_FILTER_RING	オイルフィルタ止め	1
77		236-30403	OIL_FILTER	オイルフィルタ	1
78		WP-0520656-SA	WASHER 5.2X9.5X0.6	平座金 5.2X9.5X0.6	1
79		SM-4055501-SC	SCREW M5X0.8 L=55	なべ小ねじ M5X0.8 L=55	1
80		WP-0531000-SD	WASHER M5	平座金小形丸 M5	1
81		400-13509	PLUNGER_SCREW	プランジャ止めねじ	2
82		400-41578	RUBBER_PLATE	油防ゴム支え板	1
83		400-41579	OIL_SHIELD_PLATE	油防ゴム	1
84	#02	232-04803	LUBRICATING GUIDE	面部給油ガイド	1
85	#02	400-39625	LUBRICATING_FELT	面部給油フェルト	1
86		RO-0481901-00	RUBBER RING	Oリング	2
87		400-35264	SPRING_HOOK	ばね掛け	1
88		SM-4050855-SP	SCREW	なべねじ M5 L=8	1
89		400-91198	BOX_COVER	ボックスカバー	1
90		400-91199	BOX_COVER_PACKING	ボックスカバーパッキン	1
91		EA-9500B01-00	CABLE BAND	束線バンド	2
92		EA-9500B02-00	CABLE BAND 150	束線バンド 150	1
93		401-65109	CHECK VALVE	逆止弁	1
94		SM-4050855-SP	SCREW	なべねじ M5 L=8	1
95		WP-0550800-SP	WASHER 5.5X10X0.8	平座金 5.5X10X0.8	8
96		BP-3000001-0R	VINYL PIPE	ビニールパイプ	0.07
97		BP-3000001-0R	VINYL PIPE	ビニールパイプ	0.025
98		BP-3000001-0R	VINYL PIPE	ビニールパイプ	0.25
99		NS-6110310-SP	NUT 11/64-40	六角ナット 11/64-40	1
100		236-28803	PLUNGER	プランジャ	2
		NOTE(注記)	#01...FOR LH-3528A,LH-3528A-7 #02...FOR LH-3568A,LH-3568A-7	LH-3528A,LH-3528A-7用 LH-3568A,LH-3568A-7用	

17. LUBRICATION COMPONENTS (FOR LH-3578A,3578A-7,3588A,3588A-7)

給油関係 (FOR LH-3578A,3578A-7,3588A,3588A-7 用)

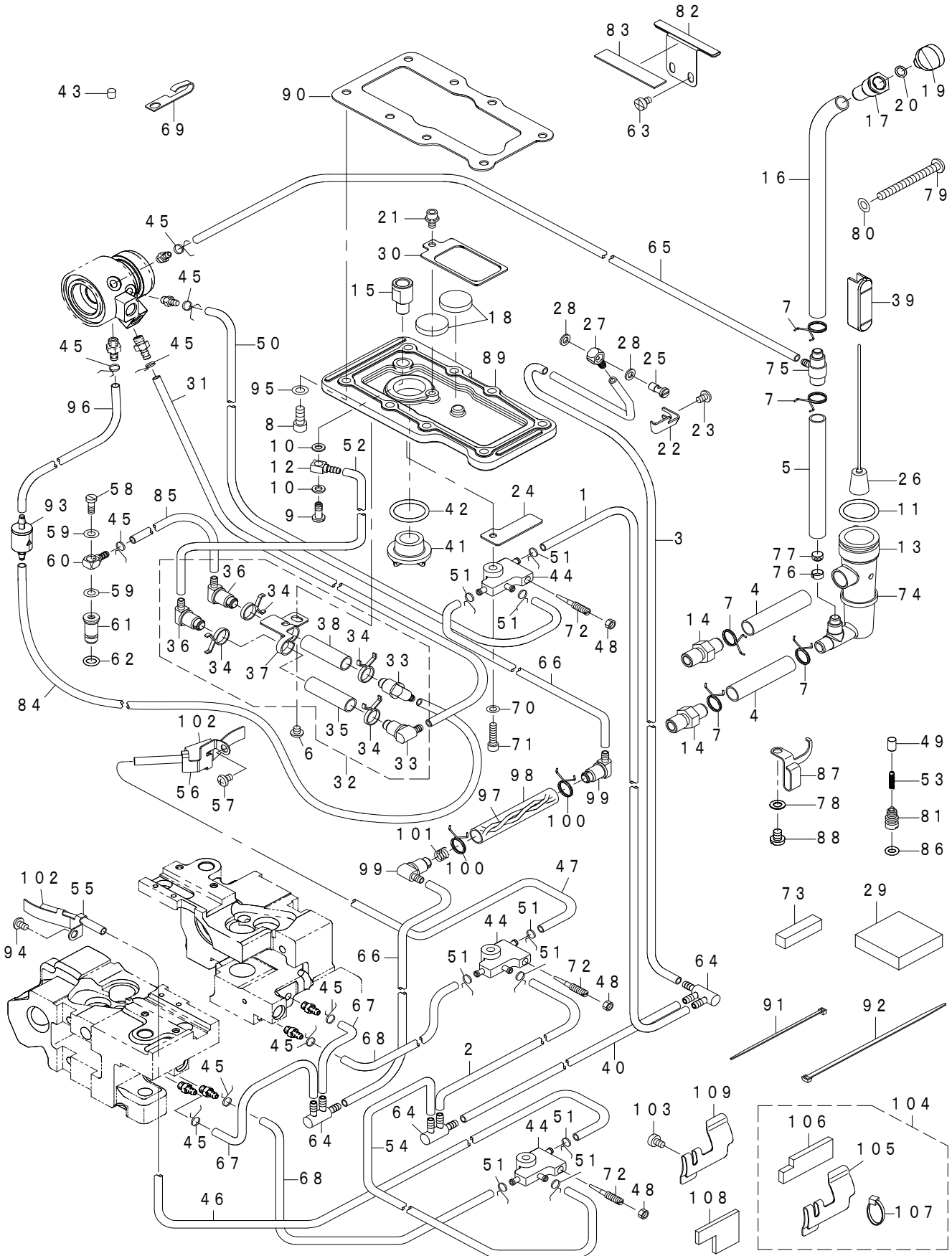

REF.NO	NOTE	PART NO	DESCRIPTION	品名	Qty
1		BP-3000001-0R	VINYL PIPE	ビニールパイプ	0.04
2		BP-3000001-0R	VINYL PIPE	ビニールパイプ	0.1
3		BP-3000001-0R	VINYL PIPE	ビニールパイプ	0.15
4		236-30106	TUBE B	チューブB	0.06
5		236-30106	TUBE B	チューブB	0.05
6		SM-40405C5-SP	SCREW	なべ小ねじ M4 L=5	1
7		236-29405	PIPE STOPPER B	パイプ止めB	5
8		SM-6051202-TP	SCREW M5X0.8 L=12	六角穴ボルト M5X0.8 L=12	8
9		B3525-357-000	CONNECTING SCREW (B)	L形連結ねじB	1
10		400-97210	GASKET	パッキン	2
11		RO-1952401-00	RUBBER RING	Oリング	1
12		SQ-0000401-MZ	CONNECTING SCREW	チューブ連結ねじ	1
13		401-60015	FLOATER_CASE	浮き子ケース	1
14		400-91202	CONNECTING_SCREW	パイプ連結ねじ	2
15		400-91200	BOX_COVER_JOINT	ボックスカバー継手	1
16		236-30106	TUBE B	チューブB	0.2
17		400-29075	LUBRICATING_INLET	給油口	1
18		B8228-125-000	OIL RESERVOIR_MAGNET	磁石	2
19		400-91195	LUBRICATING_INLET_CAP	給油口キャップ	1
20		RO-0481901-00	RUBBER RING	Oリング	1
21		SM-4040655-SP	SCREW M4 L=6	なべ小ねじ M4 L=6	1
22		400-91205	TUBE HOLDER	チューブ押え	1
23		SM-4040655-SP	SCREW M4 L=6	なべ小ねじ M4 L=6	1
24		400-91203	TUBE HOLDER	パイプ押え	1
25		SQ-2060443-SD	CONNECTING SCREW	パイプ連結ねじ	1
26		400-91196	ASSY_FLOATER	フローター (組)	1
27		SQ-0000451-MZ	CONNECTING SCREW	パイプ連結ねじ	1
28		400-04749	GASKET	Cメタル給油ジョイントパッキン	2
29		400-91238	FILTER	フィルター	1
30		400-91204	MAGNET HOLDER	マグネットホルダ	1
31		236-30007	TUBE	チューブ	0.04
32		401-60401	ASSY_OIL_FILTER	オイルフィルター (組)	1
33		236-30601	OIL_FILTER_JOINT	オイルフィルタージョイント	(2)
34		236-29405	PIPE STOPPER B	パイプ止めB	(4)
35		236-30106	TUBE B	チューブB	(0.035)
36		236-30650	OIL_FILTER_JOINT_ASM.	オイルフィルタージョイント (組)	(2)
37		401-60332	FILTER HOLDER	フィルタホルダ	(1)
38		236-30106	TUBE B	チューブB	(0.035)
39		400-36167	OIL_GAGE	オイルゲージ	1
40		BP-3000001-0R	VINYL PIPE	ビニールパイプ	0.3
41		229-24708	OIL SIGHT WINDOW	油窓	1
42		RO-1952401-00	RUBBER RING	Oリング	1
43		B3517-009-000	OIL FELT REAR	後部油止めフェルト	1
44		400-32804	BASE	油分配器	3
45		236-29306	PIPE STOPPER A	パイプ止めA	10
46		236-30007	TUBE	チューブ	0.15
47		236-30007	TUBE	チューブ	0.23
48		NS-6110310-SP	NUT 11/64-40	六角ナット 11/64-40	3
49		236-28803	PLUNGER	プランジャー	2
50		236-30007	TUBE	チューブ	0.09
51		101-26803	OIL TUBE HOLDER	パイプ止め	9
52		236-30007	TUBE	チューブ	0.09
53		236-28902	PLUNGER SPRING	プランジャーばね	2
54		BP-3000001-0R	VINYL PIPE	ビニールパイプ	0.12
55		401-51209	OIL_WICK HOLDER-L	油芯支え (左)	1
56		401-51208	OIL_WICK HOLDER-R	油芯支え (右)	1
57		SM-4050655-SP	SCREW M5 L=6	なべ小ねじ M5 L=6	1
58		B3525-357-000	CONNECTING SCREW (B)	L形連結ねじ B	1
59		400-97210	GASKET	パッキン	2
60		SQ-0000401-MZ	CONNECTING SCREW	チューブ連結ねじ	1
61		400-36333	SUCTION	給油口	1
62		RO-0371801-00	RUBBER RING	Oリング	1
63		SM-6040650-TP	SCREW	平ねじ M4 L=6	2
64		236-29504	DISTRIBUTOR	分配器A	3
65		BP-3000001-0R	VINYL PIPE	ビニールパイプ	0.3
66		236-30007	TUBE	チューブ	0.1
67		236-30007	TUBE	チューブ	0.06
68		BP-3000001-0R	VINYL PIPE	ビニールパイプ	0.12
69		262-30409	LUBRICATING OIL WICK STOPPER	給油油芯止め	1
70		WP-0430800-SD	WASHER M4	平座金小形丸 M4	1
71		SM-6041802-TP	SCREW M4 L=18	六角穴ボルト	1
72		B1834-512-000	OIL ADJUSTING SCREW	油量調節ねじ	3
73		226-03708	FELT	フェルト	1
74		EA-9500B02-00	CABLE BAND 150	結束バンド 150	1
75		400-40909	OIL_JOINT	オイルジョイント	1
76		236-30502	OIL_FILTER_RING	オイルフィルター止め	1
77		236-30403	OIL_FILTER	オイルフィルター	1
78		WP-0520656-SA	WASHER 5.2X9.5X0.6	平座金 5.2X9.5X0.6	1
79		SM-4055501-SC	SCREW M5X0.8 L=55	なべ小ねじ M5X0.8 L=55	1
80		WP-0531000-SD	WASHER M5	平座金小形丸 M5	1
81		400-13509	PLUNGER_SCREW	プランジャー止めねじ	2
82		400-41578	RUBBER_PLATE	油防ゴム支え板	1
83		400-41579	OIL_SHIELD_PLATE	油防ゴム	1
84		BP-3000001-0R	VINYL PIPE	ビニールパイプ	0.025
85		BP-3000001-0R	VINYL PIPE	ビニールパイプ	0.25
86		RO-0481901-00	RUBBER RING	Oリング	2
87		400-35264	SPRING_HOOK	ばね掛け	1
88		SM-4050855-SP	SCREW	なべねじ M5 L=8	1
89		400-91198	BOX_COVER	ボックスカバー	1
90		400-91199	BOX_COVER_PACKING	ボックスカバーパッキン	1
91		EA-9500B01-00	CABLE BAND	束線バンド	2
92		EA-9500B02-00	CABLE BAND 150	束線バンド 150	1
93		401-65109	CHECK VALVE	逆止弁	1
94		SM-4050855-SP	SCREW	なべねじ M5 L=8	1
95		WP-0550800-SP	WASHER 5.5X10X0.8	平座金 5.5X10X0.8	8
96		BP-3000001-0R	VINYL PIPE	ビニールパイプ	0.07
97		CQ-3030000-00	COTTON OIL WICK D=3	木綿油芯 D=3	0.26
98		236-30106	TUBE B	チューブB	0.009
99		236-30601	OIL_FILTER_JOINT	オイルフィルタージョイント	2
100		236-29405	PIPE STOPPER B	パイプ止めB	2
101		122-10803	SPRING	揺動桿押えばね	1
102		B3561-771-000	OIL UNWOVEN CLOTH	上輪ギヤ不織布	2
103	*	SM-6040650-TP	SCREW	ヒラネジ M4 L=6	1
104	* #01	403-00891	ASSY_LUBRICATING_GUIDE	面部給油ガイド組	1
105	*	232-04803	LUBRICATING GUIDE	メンブキユウユガイド	(1)
106	*	403-00491	FELT	フェルト	(1)
107	*	A4078-009-000	BAND (SMALL)	ソクセンバンド	(1)
108	* #02	400-39625	LUBRICATING FELT	メンブキユウユフェルト	1
109	* #02	232-04803	LUBRICATING GUIDE	メンブキユウユガイド	1
		NOTE (注記)	#01...FOR LH-3578A,LH-3578A-7 #02...FOR LH-3588A,LH-3588A-7	LH-3578A,LH-3578A-7用 LH-3588A,LH-3588A-7用	

18. BELT COVER & BOBBIN WINDER COMPONENTS

ベルトカバー・糸巻き装置関係

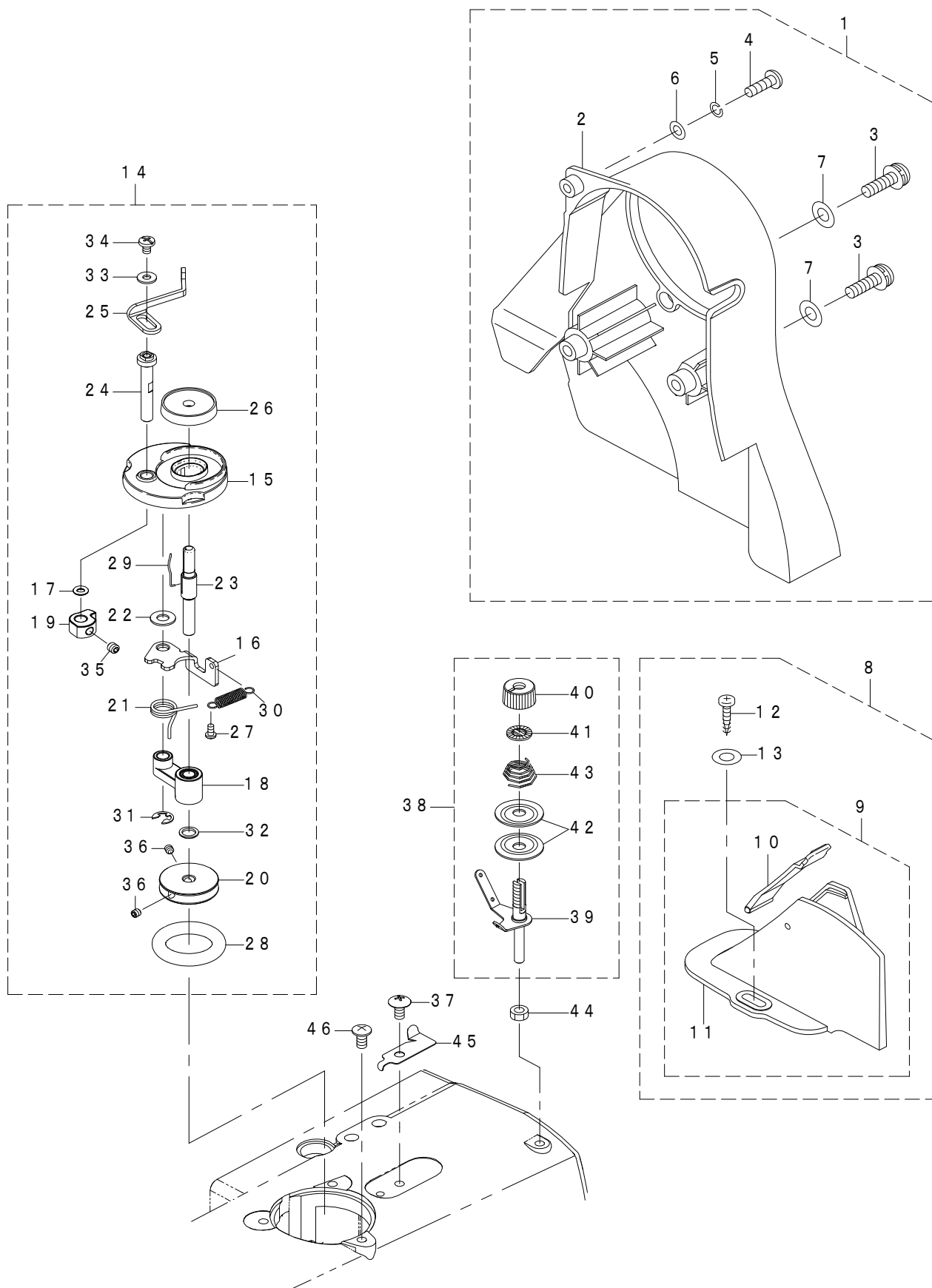

REF.NO	NOTE	PART NO	DESCRIPTION	品名	Qty
1		400-89557	ASSY_BELT_COVER-A	ベルトカバーA (組)	1
2		400-89558	BELT_COVER-A	ベルトカバーA	(1)
3		SM-4062001-SC	SCREW M6 L=20	なべ小ねじ M6 L=20	(2)
4		SM-4051601-SC	SCREW M5X0.8 L=16	なべ小ねじ M5X0.8 L=16	(1)
5		WS-0521010-KN	SPRING WASHER 5.2X8.2X1	ばね座金 5.2X8.2X1	(1)
6		WP-0531001-SC	WASHER	平座金みがき丸 M5	(1)
7		WP-0641600-SC	WASHER 6.4X12.5X1.6	平座金	(2)
8		400-34267	ASSY_BELT_COVER_B	ベルトカバーB組	1
9		229-33659	BELT_COVER_B_COMPL.	ベルトカバーB (結合)	(1)
10		229-33758	BELT_COVER_B_LID_ASM.	ベルトカバーB蓋 (組)	(1)
11		229-33600	BELT_COVER_B	ベルトカバーB	(1)
12		SK-3412000-SC	WOOD SCREW D=4.1 L=20	丸木ねじ D=4.1 L=20	(2)
13		WP-0501016-SC	WASHER 5X10.5X1	平座金 5X10.5X1	(2)
14		402-82075	BOBBIN_WINDER_UNIT	糸巻装置 (組)	1
15		402-81957	BTW_BASE	イトマキトリツケダイ	(1)
16		401-66886	BOBBIN_WINDER_LEVER	糸巻き調節板	(1)
17		401-66894	O_RING	Oリング	(1)
18		402-81969	SHAFT_SUPPORT_ASM	糸巻腕組	(1)
19		401-66885	BOBBIN_PRESSER_CAM	糸巻きカム	(1)
20		402-82051	BOBBIN_WINDER_WHEEL	糸巻き車N	(1)
21		401-66888	SPRING	糸巻き振りばね	(1)
22		402-81959	WASHER	座金	(1)
23		402-81942	BTW_SHAFT	糸巻き軸	(1)
24		402-81941	BTW_LEVER_SHAFT	糸巻きレバー軸	(1)
25		401-91115	BOBBIN_PRESSER_N	糸巻きレバーN	(1)
26		401-66872	BOBBIN_SUPPORT	ボビン座	(1)
27		ST-4030651-SN	SCREW M3 X 6	タツピンネジ	(1)
28	☆	262-61503	BTW_WHEEL RUBBER	糸巻き摩擦車	(1)
29		401-66881	BOBBIN_FIXED_SPRING	ボビン止めばね	(1)
30		401-66887	BOBBIN_WINDER_LEVER_SPRING	糸巻き調節板戻しばね	(1)
31		RE-0500000-K0	E-RING	E形止め輪5	(1)
32		228-91204	BEARING_SUPPORT	ベアリングオサエ	(1)
33		401-66870	WASHER	平座金	(1)
34		SM-5040655-SN	SCREW	バインドねじ	(1)
35		SM-8050502-TP	SCREW M5 L=5	止めねじ	(1)
36		SM-8040412-TP	SCREW M4X4	トメネジ M4X4	(2)
37		SM-0050801-SC	SCREW	トラスねじ M5 L=8	1
38		400-91212	BOBBIN_THREAD_TENSION_ASM.	糸巻き糸調子 (組)	1
39		400-91241	BOBBIN_THREAD_TENSION_ROD_ASM.	糸巻き糸調子棒 (結合)	(1)
40		229-21308	THREAD_TENSION_NUT	糸調子ナット	(1)
41		229-21407	ROTATION_STOPPER	糸調子皿回転止め	(1)
42		229-21506	THREAD_TENSION_DISK	糸調子皿	(2)
43		229-21704	THREAD_TENSION_SPRING_A	糸調子ばね (A)	(1)
44		NM-6050001-SD	NUT M5X0.8	六角ナット M5X0.8 1種	1
45		400-37008	THREAD_CUTTER	糸切り保持板	1
46		402-82052	SCREW	トラスネジ M5 L=8	3

19. BOTTOM COVER COMPONENTS

ボトムカバー関係

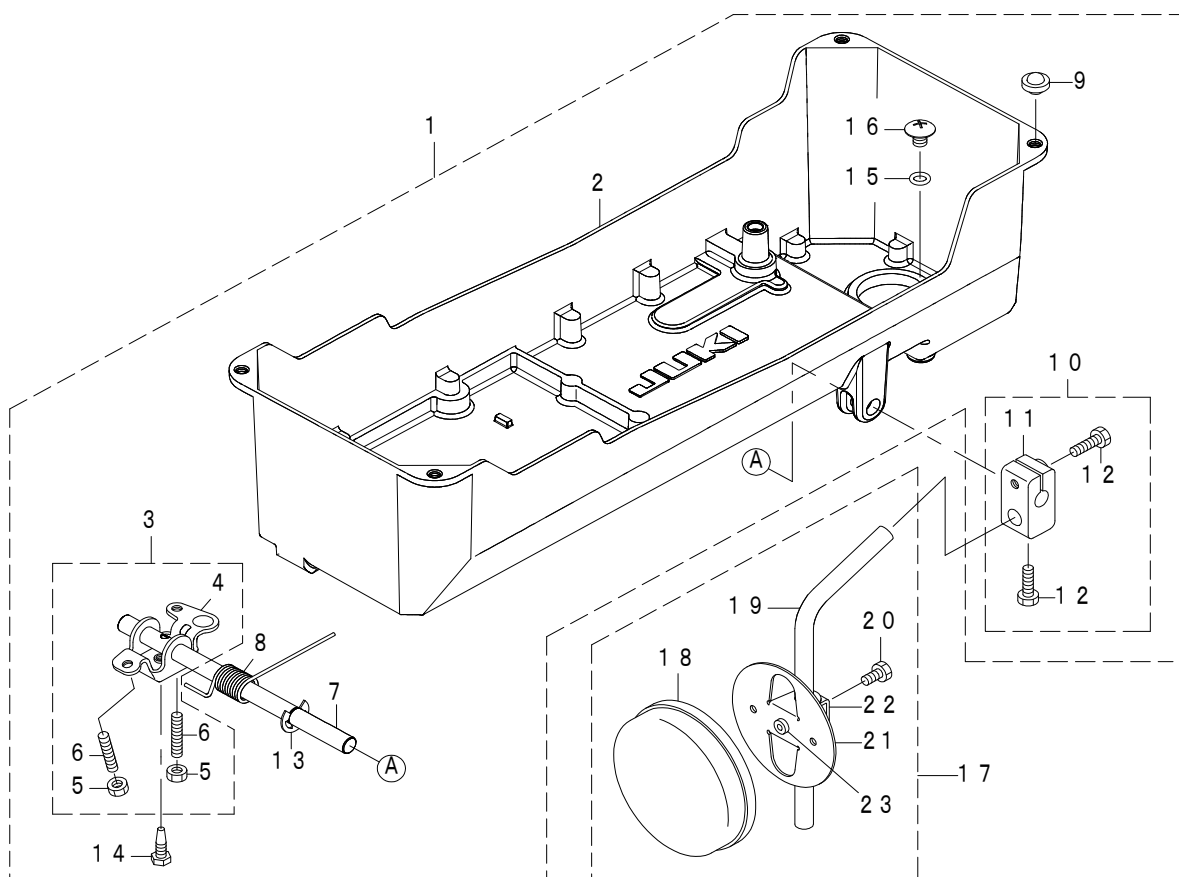

REF.NO	NOTE	PART NO	DESCRIPTION	品名	Qty
1		400-32107	ASSY_BOTTOM_COVER_A	ボトムカバーA組	1
2		400-28778	BOTTOM_COVER	ボトムカバー	(1)
3		400-34853	CONNECTING_ROD_ASM.	膝上げ回転腕組	(1)
4		229-32107	KNEE_LIFTING_ROTATING_ARM	膝上げ回転腕	(1)
5		NM-6060001-SE	NUT M6	六角ナット M6 1種	(2)
6		SM-8063012-TR	SCREW M6 L=30	止めねじ	(2)
7		400-25191	KNEE_PRESS_ROD	膝当て横軸	(1)
8		229-32206	SPRING	膝上げ回転腕ばね	(1)
9		B1116-210-D00	FRAME_SUPPORT_RUBBER	頭部支えゴム	(4)
10		229-32453	BRACKET_ASM.	膝当て縦軸取付け腕(組)	(1)
11		229-32404	BRACKET	膝当て縦軸取付け腕	(1)
12		229-34707	SCREW	膝当て縦軸取付け腕締めねじ	(2)
13		RE-1000000-K0	E-RING 10	E形止め輪 10	(1)
14		SM-9061853-SR	SCREW M6 L=17.5	六角ボルト	(1)
15		131-70105	RUBBER_RING	Oリング	(1)
16		131-71004	DRAIN_SCREW	排油ねじ	(1)
17	#01	229-34251	KNEE_PAD_PLATE_ASM.	膝当て板(組)	1
18		229-34509	KNEE_PAD_PLATE_COVER	膝当て板カバー	(1)
19		229-34608	KNEE_PAD_UPRIGHT_SHAFT	膝当て縦軸	(1)
20		SM-9061203-SE	SCREW M6 L=12	六角ボルト M6 L=12	(1)
21		229-34202	KNEE_PAD_PLATE	膝当て板	(1)
22		229-34301	KNEE_PAD_PLATE_SUPPORT	膝当て板支え	(1)
23		229-34400	KNEE_PAD_PLATE_RUBBER	膝当て板ゴム	(1)
		NOTE(注記)	#01....ACCESSORIE PARTS	付属品	

20. AK DEVICE COMPONENTS

AK 装置関係

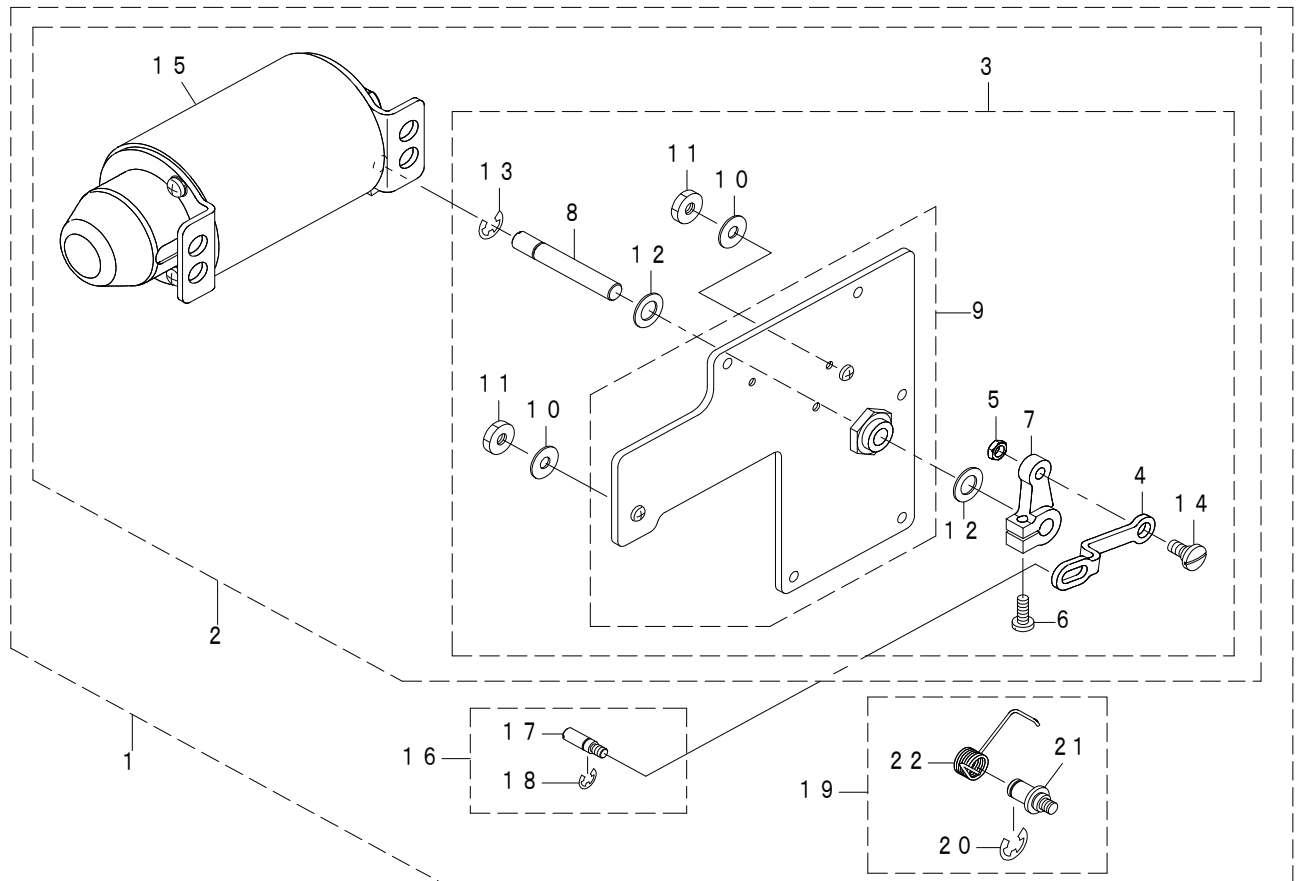

REF.NO	NOTE	PART NO	DESCRIPTION	品名	Qty
1		400-55883	AK135	AK135	1
2		400-36221	ASSY_AK_DEVICE	AK装置組	(1)
3		400-36222	COMP_REAR_PLATE	窓板結合	(1)
4		400-30962	SOLENOID_LINK	ソレノイドリンク	(1)
5		NS-6150310-SP	NUT 15/64-28	六角ナット 15/64-28	(1)
6		SS-7121410-TP	SCREW 3/16-28 L=14	丸平ねじ 3/16-28 L=14	(1)
7		GAK-33027000	SOLENOID ARM	ソレノイド腕B	(1)
8		229-91400	SOLENOID SHAFT	ソレノイド軸	(1)
9		400-36223	ASSY_REAR_PLATE	窓板組	(1)
10		WP-0621036-SP	WASHER	平座金	(2)
11		NS-6150440-SP	NUT 15/64-28	六角ナット 15/64-28	(2)
12		WP-1021016-SD	WASHER	平座金 10.2X18X1	(2)
13		RE-0700000-K0	E-RING 7	E形止め輪 7	(1)
14		SD-0800352-SP	HINGE SCREW D=8 H=3.5	段ねじ D=8 H=3.5	(1)
15		401-01423	AK SOLENOID ASM. B	AKソレノイド組B	(1)
16		400-59504	ASSY SHAFT_PIN	膝上げ横棒ピン組	(1)
17		400-30954	SHAFT_PIN	膝上げ横棒ピン	(1)
18		RE-0500000-K0	E-RING	E形止め輪 5	(1)
19		400-59505	ASSY AK PIN	自動押え上げ支点組	(1)
20		RE-0800000-K0	E-SHAPED SNAP RING (8MM)	E形止め輪 8	(1)
21		400-56385	AK_LINK_SHAFT	自動押え上げリンク支点	(1)
22		400-56438	AK_RETURN_SPRING	自動押え上げ戻しばね	(1)

21. THREAD STAND COMPONENTS

糸立装置関係

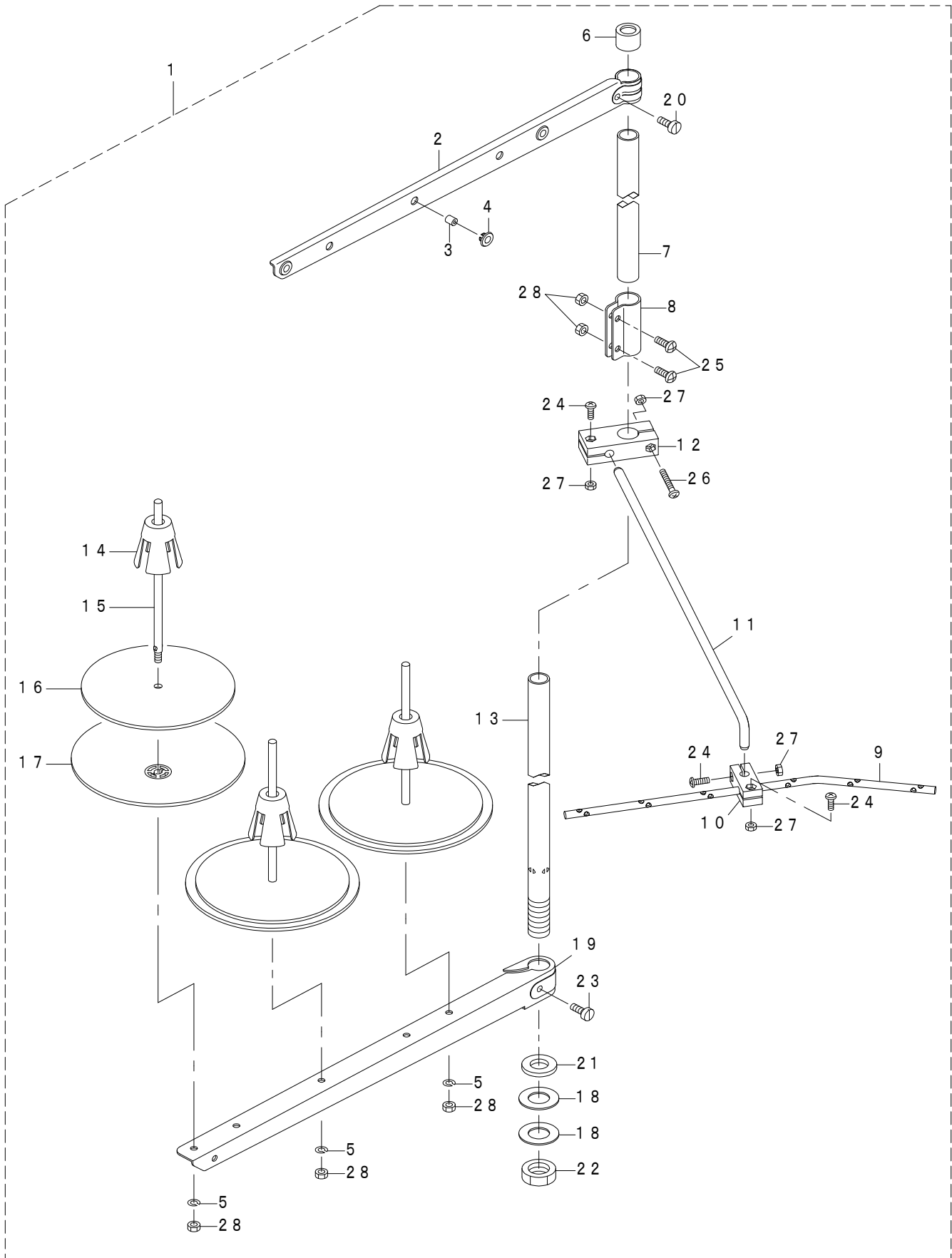

REF.NO	NOTE	PART NO	DESCRIPTION	品名	Qty
1		400-97211	THREAD STAND ASM.	糸立装置 (組)	1
2		401-06575	SPOOL REST LONG ARM UPPER	糸立糸案内 (長)	(1)
3		400-85794	THREAD GUIDE	糸道	(3)
4		400-85795	THREAD GUIDE BUSHING	糸道ブッシュ	(3)
5		WS-0510002-KN	SPRING WASHER M5	ばね座金 M5	(3)
6		400-85793	SPOOL REST ROD RUBBER CAP	糸立棒保護キャップ	(1)
7		400-85785	SPOOL REST ROD UPPER	糸立棒 (上)	(1)
8		400-85792	SPOOL REST ROD JOINT	糸立棒継手	(1)
9		401-06583	THREAD GUIDE 6	糸立糸案内下 (6本糸)	(1)
10		401-06580	THREAD GUIDE UNDER BASE	糸立糸案内下台	(1)
11		401-06576	THREAD GUIDE ARM	糸立糸案内腕	(1)
12		401-06579	THREAD GUIDE ARM BASE	糸立糸案内腕台	(1)
13		400-85784	SPOOL REST ROD LOWER	糸立棒 (下)	(1)
14		400-85791	SPOOL RETAINER	糸巻振れ止め	(3)
15		400-85790	SPOOL PIN	糸巻受棒	(3)
16		400-85789	SPOOL REST CUSHION	糸巻受皿クッション	(3)
17		400-85788	SPOOL REST	糸巻受皿	(3)
18	*	402-98217	SPOOL_REST_ROD_WASHER	糸立て棒座金	(2)
19		401-06574	SPOOL REST LONG ARM LOWER	糸立腕下 (長)	(1)
20		400-96327	SPOOL REST ARM UPPER SCREW	糸立腕 (上) 止めねじ	(1)
21		400-85796	SPOOL REST ROD RUBBER CUSHION	糸立棒防振ゴム	(1)
22		400-96325	SPOOL REST ROD NUT	糸立棒止ナット	(1)
23		400-96326	SPOOL REST ARM LOWER SCREW	糸立腕 (下) 止めねじ	(1)
24		SM-4041201-SC	SCREW M4 L=12	なべ小ねじ M4 L=12	(3)
25		SM-4051405-SE	SCREW M5 L=14	なべ小ねじ M5 L=14	(2)
26		SM-4042501-SC	SCREW M4X0.7 L=25	なべ小ねじ M4X0.7 L=25	(1)
27		NM-6040002-SC	NUT M4	六角ナット M4X0.7 2種	(4)
28		NM-6050001-SE	NUT M5	六角ナット M5	(5)

22. ACCESSORIE PARTS COMPONENTS



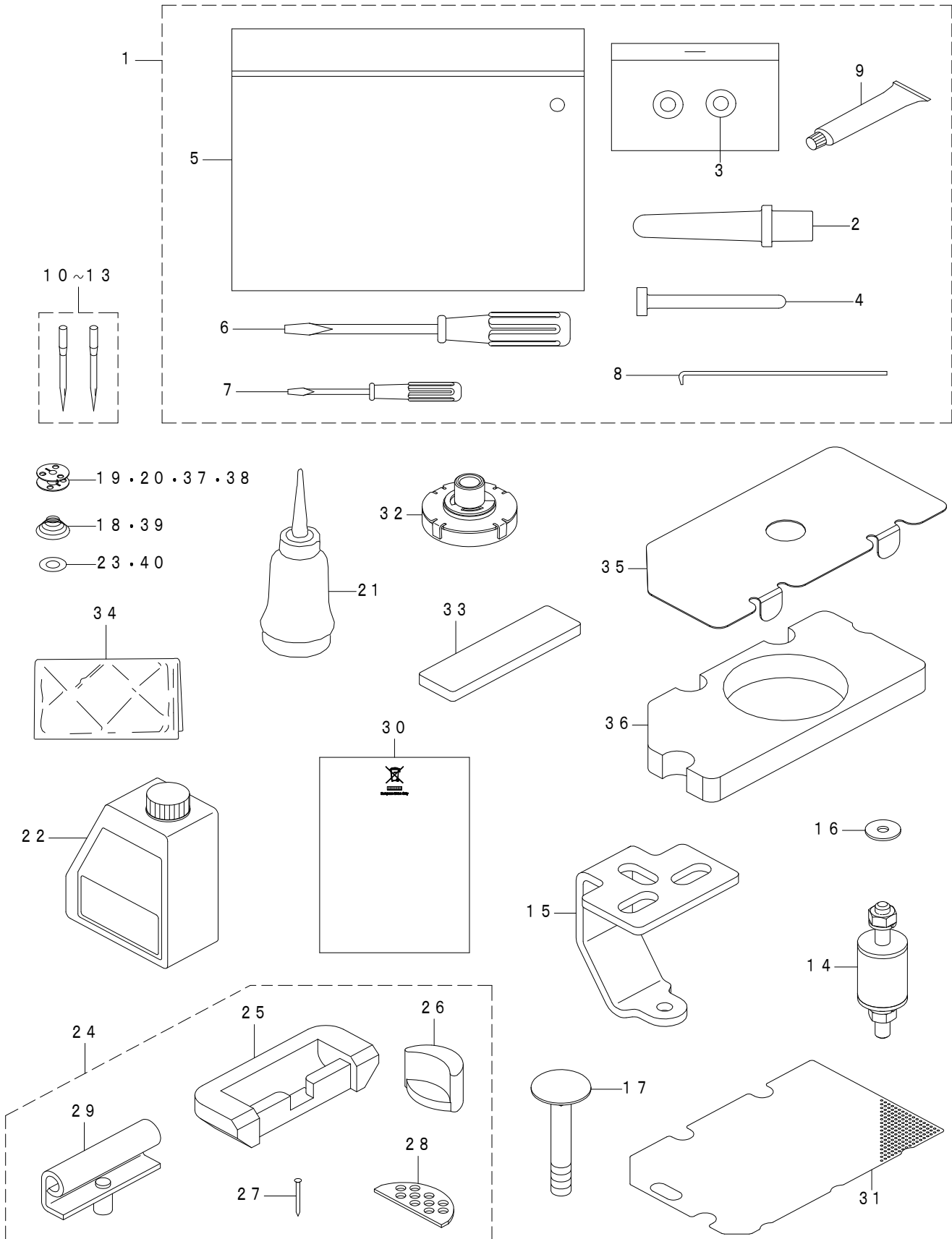

付属品関係

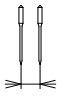
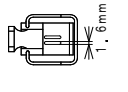

REF.NO	NOTE	PART NO	DESCRIPTION	品名	Qty
1		400-91282	ACCESSORIE BAG ASM.	付属品バック (組)	1
2		229-31604	FRAME SUPPORT BAR	頭部支え棒	(1)
3		WP-0531000-SC	WASHER 5.3X10X1	平座金 5.3X10X1	(2)
4		400-56705	KNEE_LIFTER_PRESSER_ROD	膝上げ押し棒	(1)
5		229-32800	ACCESSORIE BAG	付属品バック	(1)
6		229-33105	SCREW DRIVER MIDDLE	ドライバー (中)	(1)
7		229-33204	SCREW DRIVER SMALL	ドライバー (小)	(1)
8		B9101-490-000	DRIVER	ドライバー	(1)
9		400-06323	JUKI GREASE A TUBE	ジューキグリースAチューブ	(1)
10	☆	#06 MDP-500B0902	NEEDLE DPX5#9-2	針 DPX5#9-2	1
11	☆	#04 MDP-500B1002	NEEDLE DPX5 #10-2	針 DPX5 #10-2	1
12	☆	#03 MDP-500B1402	NEEDLE DPX5#14-2	DPX5#14-2	1
13	☆	#05 MDP-500B2102	DPX5#21-2	針 DPX5#21-2	1
14		#08 400-92944	RUBBER MOUNTING	ラバーマウント	3
15		#08 400-93056	BASE PLATE	取付け板	3
16		#08 WP-0651646-SC	WASHER	平座金	3
17		#08 400-93057	BOLT	モータ取付けボルト	3
18	☆	#01 101-11508	SPRING	空転防止ばね	2
19	☆	#01 102-10805	HARD ALUMITE BOBBIN	硬質アルマイト ボビン	2
20	☆	#02 B9117-051-000	BOBBIN	ボビン	2
21		B9121-012-0A0	OILER ASM.	油差し組	1
22		401-02087	JUKI_MACHINE_OIL_7	JUKI マシンオイル 7	1
23	☆	#01 226-53802	SHEET	空転防止シート	2
24		229-58052	RUBBER HINGE ASM.	ラバーヒンジ (組)	1
25		229-26000	RUBBER CUSHION	ゴムヒンジ座	(2)
26		229-58003	FRAME BUBBER CUSHION	頭部支えゴム座	(2)
27		229-26208	NAIL	ゴムヒンジ座打ち釘	(8)
28		229-26505	WASHER	頭部クッション座	(2)
29		229-26356	HINGE COMPL.	ヒンジ結合	(2)
30		#07 CM-6001002-01	WEEE INFORMATION SHEET	W E E インフォメーション シート	2
31		400-30768	OIL_FILTER	オイルフィルタ	1
32		400-36428	ASSY_FILTER_A	フィルターA 組	1
33		400-35873	FILTER_B	フィルターB	1
34		229-33303	VINYL COVER	頭部ビニールカバー	1
35		#09 401-20727	FILTER_PLATE	フィルター板	1
36		#09 401-20728	FILTER_C	フィルターC	1
37	*	#10 402-35203	BOBBIN	ボビン	2
38	*	#11 B9117-563-000	BOBBIN	ボビン	2
39	*	#10 400-55358	SPRING_L	クウテンボウシバネ_L	2
40	*	#10 228-19809	SHEET	クウテンボウシシート (オオガマ)	2
		NOTE(注記)	#01....FOR LH-3528A-7,3568A-7	LH-3528A-7,3568A-7 用	
			#02....FOR LH-3528A,3568A	LH-3528A,3568A 用	
			#03....TYPE S	S 仕様	
			#04....TYPE F	F 仕様	
			#05....TYPE G	G 仕様	
			#06....TYPE A	A 仕様	
			#07....FOR JE	JE 用	
			#08....FOR LH-3528A-7,3528A-0B,3568A-7,3578A-7,3588A-7	LH-3528A-7,3528A-0B,3568A-7,3578A-7,3588A-7 用	
			#09....FOR CHINA	中国向	
			#10....FOR LH-3578A-7,LH-3588A-7	LH-3578A-7,LH-3588A-7 用	
			#11....FOR LH-3578A,LH-3588A	LH-3578A,LH-3588A	

23. TABLE OF EXCHANGING GAUGE PARTS (1)(FOR LH-3528A)

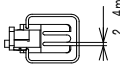
交換ゲージ部品一覧表 (1) (LH-3528A 用)

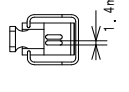
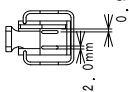
Needle gauge size 針 幅			Presser foot asm. 押 さ え (組)										Swivel guide Presser asm. スィブルガイド 押さえ (組)		
Code コード					(Tip-divided) (移動式先割れ) 		(Tip-divided) (移動式先割れ) 		(Lower feed) (下送り) 						
	inch	mm	No.	Part No.	No.	Part No.	No.	Part No.	No.	Part No.	No.	Part No.	No.	Part No.	
A	3/32	2.4	1	226-37557	—	—	—	—	—	—	—	—	—		
B	1/8	3.2	2	226-37656	15	400-35896	—	—	50	103-91852	57	226-27152	63	226-47051	
C	5/32	4.0	3	226-37755	16	400-35897	33	400-71909	—	—	—	—	—		
D	3/16	4.8	4	226-37854	17	226-40353	34	228-16557	51	103-92058	58	226-27350	64	226-47150	
E	7/32	5.6	—	—	18	226-40452	35	228-16656	—	—	59	226-27459	65	※400-95293	
F	1/4	6.4	5	226-38050	19	226-40551	36	228-16755	52	103-92256	60	226-27558	66	※402-29461	
G	9/32	7.1	6	226-38258	20	226-40759	37	228-16854	—	—	61	226-27657	67	226-47358	
H	5/16	7.9	7	226-38357	21	226-40858	38	228-16953	—	—	62	226-27756	68	※400-94776	
K	3/8	9.5	8	226-38456	22	226-40957	39	228-17050	—	—	—	—	69	226-47457	
W	7/16	11.1	—	—	23	226-41054	40	400-33941	—	—	—	—	70	226-47556	
L	1/2	12.7	9	226-38753	24	226-41252	41	228-17159	53	103-92751	—	—	—	—	
M	5/8	15.9	—	—	25	226-41351	42	400-33945	—	—	—	—	—	—	
N	3/4	19.1	10	226-38951	26	226-41450	43	400-33947	54	103-93056	—	—	—	—	
P	7/8	22.2	11	226-39157	27	226-41658	44	400-33949	55	228-44450	—	—	—	—	
Q	1	25.4	12	226-39256	28	226-41757	45	400-33951	56	228-44559	—	—	—	—	
R	1-1/8	28.6	13	226-39355	29	226-41856	46	400-33953	—	—	—	—	—	—	
S	1-1/4	31.8	14	226-39454	30	226-41955	47	400-33955	—	—	—	—	—	—	
T	1-3/8	34.9	—	—	31	226-42052	48	400-33957	—	—	—	—	—	—	
U	1-1/2	38.1	—	—	32	226-42151	49	400-33959	—	—	—	—	—	—	
Stitch spec. 縫 仕 様	A	★													
	F												★		★ (テーフ* 付け)
	S												★		
	G												★		
	下送り												★		

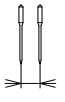
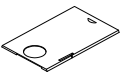
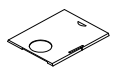
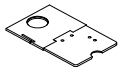
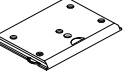
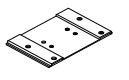
Needle gauge size 針 幅			Sliding plate asm. (Left) 滑り板 (左) 組		Sliding plate asm. (Right) 滑り板 (右) 組		Sliding plate asm. (Left) 滑り板 (左) 組		Sliding plate asm. (Front) 滑り板 (前) 組			
Code コード												
	inch	mm	No.	Part No.	No.	Part No.	No.	Part No.	No.	Part No.	No.	Part No.
A	3/32	2.4	71	226-01058	75	226-00555	79	400-51633	83	400-42874	84	232-06709
B	1/8	3.2										
C	5/32	4.0										
D	3/16	4.8										
E	7/32	5.6										
F	1/4	6.4										
G	9/32	7.1										
H	5/16	7.9										
K	3/8	9.5										
W	7/16	11.1										
L	1/2	12.7	72	226-01157	76	226-00654	80	400-45729				
M	5/8	15.9										
N	3/4	19.1										
P	7/8	22.2										
Q	1	25.4	73	226-01256	77	226-00753	81	400-45730				
R	1-1/8	28.6										
S	1-1/4	31.8	74	226-01355	78	226-00852	82	400-45731				
T	1-3/8	34.9										
U	1-1/2	38.1										
Stitch spec. 縫 仕 様	A	Spec. common										
	F	Spec. common										
	S	Spec. common										
	G	Spec. common										
	下送り	Spec. common										

REF.NO	NOTE	PART NO	DESCRIPTION	品名	Qty
1		226-37557	PRESSER FOOT ASM.	自由押え 1.6 (組) 3/32" (2.4MM)	1
2		226-37656	PRESSER FOOT ASM.	自由押え 1.6 (組) 1/8" (3.2MM)	1
3		226-37755	PRESSER FOOT ASM.	自由押え 1.6 (組) 5/32" (4.0MM)	1
4		226-37854	PRESSER FOOT ASM.	自由押え 1.6 (組) 3/16" (4.8MM)	1
5		226-38050	PRESSER FOOT ASM.	自由押え 1.6 (組) 1/4" (6.4MM)	1
6		226-38258	PRESSER FOOT ASM.	自由押え 1.6 (組) 9/32" (7.1MM)	1
7		226-38357	PRESSER FOOT ASM.	自由押え 1.6 (組) 5/16" (7.9MM)	1
8		226-38456	PRESSER FOOT ASM.	自由押え 1.6 (組) 3/8" (9.5MM)	1
9		226-38753	PRESSER FOOT ASM.	自由押え 1.6 (組) 1/2" (12.7MM)	1
10		226-38951	PRESSER FOOT ASM.	自由押え 1.6 (組) 3/4" (19.1MM)	1
11		226-39157	PRESSER FOOT ASM.	自由押え 1.6 (組) 7/8" (22.2MM)	1
12		226-39256	PRESSER FOOT ASM.	自由押え 1.6 (組) 1" (25.4MM)	1
13		226-39355	PRESSER FOOT ASM.	自由押え 1.6 (組) 1.1/8" (28.6MM)	1
14		226-39454	PRESSER FOOT ASM.	自由押え 1.6 (組) 1.1/4" (31.8MM)	1
15		400-35896	PRESSER FOOT ASM.	先割自由押え (組) 1/8	1
16		400-35897	PRESSER FOOT ASM.	先割自由押え (組) 5/32	1
17		226-40353	PRESSER FOOT ASM.	先割自由押え (組) 3/16" (4.8MM)	1
18		226-40452	PRESSER FOOT ASM.	先割自由押え (組) 7/32" (5.6MM)	1
19		226-40551	PRESSER FOOT ASM.	先割自由押え (組) 1/4" (6.4MM)	1
20		226-40759	PRESSER FOOT ASM.	先割自由押え (組) 9/32" (7.1MM)	1
21		226-40858	PRESSER FOOT ASM.	先割自由押え (組) 5/16" (7.9MM)	1
22		226-40957	PRESSER FOOT ASM.	先割自由押え (組) 3/8" (9.5MM)	1
23		226-41054	PRESSER FOOT ASM.7/16"(11.1MM)	先割自由押え (組) 7/16" (11.1MM)	1
24		226-41252	PRESSER FOOT ASM.	先割自由押え (組) 1/2" (12.7MM)	1
25		226-41351	PRESSER FOOT ASM.	先割自由押え (組) 5/8" (15.9MM)	1
26		226-41450	PRESSER FOOT ASM.	先割自由押え (組) 3/4" (19.1MM)	1
27		226-41658	PRESSER FOOT ASM.	先割自由押え (組) 7/8" (22.2MM)	1
28		226-41757	PRESSER FOOT ASM.	先割自由押え (組) 1" (25.4MM)	1
29		226-41856	PRESSER FOOT ASM.	先割自由押え (組) 1.1/8" (28.6MM)	1
30		226-41955	PRESSER FOOT ASM.	先割自由押え (組) 1.1/4" (31.8MM)	1
31		226-42052	PRESSER FOOT ASM.	先割自由押え (組) 1.3/8" (34.9MM)	1
32		226-42151	PRESSER FOOT ASM.	先割自由押え (組) 1.1/2" (38.1MM)	1
33		400-71909	PRESSER_FOOT_ASM_G_5/32	先割自由押え G (組) 5/32	1
34		228-16557	TIP-DIVIDED PRESSER ASM. 3/16	先割自由押え 2.4 (組) 3/16"	1
35		228-16656	TIP-DIVIDED PRESSER ASM. 7/32	先割自由押え 2.4 (組) 7/32"	1
36		228-16755	PRESSER FOOT ASM. 1/4"	先割自由押え 2.4 (組) 1/4"	1
37		228-16854	TIP-DIVIDED PRESSER ASM. 9/32	先割自由押え 2.4 (組) 9/32"	1
38		228-16953	TIP-DIVIDED PRESSER ASM. 5/16	先割自由押え 2.4 (組) 5/16"	1
39		228-17050	PRESSER FOOT ASM. D=2.4 (3/8)	先割自由押え 2.4 (組) 3/8"	1
40		400-33941	TIP-DIVIDED_PRESSER_ASM_7/16	先割自由押え 2.4 (組) 7/16	1
41		228-17159	PRESSER FOOT ASM. D=2.4 (1/2)	先割自由押え 2.4 (組) 1/2"	1
42		400-33945	TIP-DIVIDED_PRESSER_ASM_5/8	先割自由押え (組) 5/8	1
43		400-33947	TIP-DIVIDED_PRESSER_ASM_3/4	先割自由押え (組) 3/4	1
44		400-33949	TIP-DIVIDED_PRESSER_ASM_7/8	先割自由押え (組) 7/8	1
45		400-33951	TIP-DIVIDED_PRESSER_ASM_1	先割自由押え (組) 1	1
46		400-33953	TIP-DIVIDED_PRESSER_ASM_1_1/8	先割自由押え (組) 1_1/8	1
47		400-33955	TIP-DIVIDED_PRESSER_ASM_1_1/4	先割自由押え (組) 1_1/4	1
48		400-33957	TIP-DIVIDED_PRESSER_ASM_1_3/8	先割自由押え (組) 1_3/8	1
49		400-33959	TIP-DIVIDED_PRESSER_ASM_1_1/2	先割自由押え (組) 1_1/2	1
50		103-91852	PRESSER FOOT ASM. 1/8	自由押え組 1/8	1
51		103-92058	PRESSER FOOT ASM. 3/16	自由押え組	1
52		103-92256	PRESSER FOOT ASM. 1/4	自由押え組 1/4	1
53		103-92751	PRESSER FOOT ASM. 1/2	自由押え組 1/2	1
54		103-93056	PRESSER FOOT ASM. 3/4	自由押え組 3/4	1
55		228-44450	COMPENSATING PRESSER ASM.(7/8)	自由押え (組) 7/8"	1
56		228-44559	BOBBIN CASE ASM, HEAVY FABLIC.	自由押え (組) 1	1
57		226-27152	PRESSER FOOT F ASM. 1/8	F自由押え (組) 1/8"	1
58		226-27350	F PRESSER FOOT ASM. 3/16	F自由押え (組) 3/16"	1
59		226-27459	PRESSER FOOT ASM., 7/32"	F自由押え (組) 7/32"	1
60		226-27558	PRESSER FOOT F ASM. 1/4	F自由押え (組) 1/4"	1
61		226-27657	PRESSER FOOT ASM., F 9/32	F自由押え (組) 9/32"	1
62		226-27756	PRESSER FOOT ASM., F 5/16	F自由押え (組) 5/16"	1
63		226-47051	SWIVEL GUIDE PRESSER 1/8" ASM.	スイブルガイド押え (組) 1/8"	1
64		226-47150	GUIDE PRESSER ASM. 3/16"	スイブルガイド押え (組) 3/16"	1
65	#01	400-95293	ASSY_PRESSER_FOOT_G3/16	スイブルガイド押え 3/16	1
66		226-47259	GUIDE PRESSER ASM. 7/32"	スイブルガイド押え (組) 7/32"	1
67		226-47358	GUIDE PRESSER ASM. 1/4"	スイブルガイド押え (組) 1/4"	1
68	#01	400-94776	ASSY_PRESSER_FOOT_G1/4	スイブルガイド押え	1
69		226-47457	GUIDE PRESSER ASM. 9/32	スイブルガイド押え (組) 9/32"	1
70		226-47556	SWIVEL GUIDE PRESSER 5/16" ASM	スイブルガイド押え (組) 5/16"	1
71		226-01058	BED SLIDE LEFT, ASM., A	スベリタ (左) A組	1
72		226-01157	LEFT SLIDER PLATE B ASM.	スベリタ (左) B組	1
73		226-01256	BED SLIDE LEFT, ASM., C	スベリタ (左) C組	1
74		226-01355	BED SLIDE LEFT, ASM., D	スベリタ (左) D組	1
75		226-00555	BED SLIDE RIGHT, ASM., A	スベリタ (右) A組	1
76		226-00654	RIGHT SLIDER PLATE B ASM.	スベリタ (右) B組	1
77		226-00753	BED SLIDE RIGHT, ASM., C	スベリタ (右) C組	1
78		226-00852	BED SLIDE RIGHT, ASM., D	スベリタ (右) D組	1
79		400-51633	ASSY_SLIDE_PLATE_L	はね上げ式滑り板組	1
80		400-45729	ASSY_SIDE_PLATE-L-B	滑り板左組	1
81		400-45730	ASSY_SIDE_PLATE-L-C	滑り板左組	1
82		400-45731	ASSY_SIDE_PLATE-L-D	滑り板左組	1
83		400-42874	ASSY_SLIDE_PLATE_F_STANDARD	滑り板前糸切り無組	1
84		232-06709	BED SLIDE (FRONT)A	滑り板 (前) A	1
85	#02	402-29461	ASSY_PRESSER_FOOT_G3/16	スイブルガイド押え 3/16"	1
86	#02	402-29459	ASSY_PRESSER_FOOT_G_1/4	スイブルガイド押え G (組) 1/4"	1
		NOTE(注記)	#01...EDGE 3mm #02...EDGE 2mm	コバ 3mm コバ 2mm	

24. TABLE OF EXCHANGING GAUGE PARTS (2)(FOR LH-3528A)

交換ゲージ部品一覧表 (2) (LH-3528A 用)

Needle gauge size 針 幅		Feed Dog 送り 歯																
Code コード*	Needle gauge size		1.2		1.4		1.4		1.7		1.7		1.7		2.2		2.2mm	
	inch	mm	No.	Part No.	No.	Part No.	No.	Part No.	No.	Part No.	No.	Part No.	No.	Part No.	No.	Part No.	No.	Part No.
A	3/32	2.4	1	400-33714														
B	1/8	3.2	2	400-33715	15	400-35883	21	400-33563							61	B1613-512-B0H		
C	5/32	4.0	3	400-33716														
D	3/16	4.8	4	400-33718	16	400-35884	22	400-33564	28	226-30404	45	400-25785	63	B1613-512-D0H			79	400-25801
E	7/32	5.6			17	400-35885	23	400-33565	29	226-30503	46	400-25786	64	B1613-512-E0H	80	400-25802		
F	1/4	6.4	5	400-33720	18	400-35886	24	400-33566	30	226-30602	47	400-25787	65	B1613-512-F0H	81	400-25803		
G	9/32	7.1	6	400-33722	19	400-35887	25	400-33567	31	226-30800	48	400-25788	66	B1613-512-G0H	82	400-25804		
H	5/16	7.9	7	400-33723	20	400-35888	26	400-33568	32	226-30909	49	400-25789	67	B1613-512-H0H	83	400-25805		
K	3/8	9.5	8	400-33724					33	226-31006	50	400-25790	68	B1613-512-K0H	84	400-25806		
W	7/16	11.1							34	226-31105	51	400-25791	69	400-75311	85	400-25807		
L	1/2	12.7	9	400-33727					35	226-31303	52	400-25792	70	B1613-512-L0H	86	400-25808		
M	5/8	15.9							36	226-31402	53	400-25793	71	B1613-512-M0H	87	400-25809		
N	3/4	19.1	10	400-33729					37	226-31501	54	400-25794	72	B1613-512-N0H	88	400-25810		
P	7/8	22.2	11	400-33731					38	226-31709	55	400-25795	73	B1613-512-P0H	89	400-25811		
Q	1	25.4	12	400-33732					39	226-31808	56	400-25796	74	B1613-512-Q0H	90	400-25812		
R	1-1/8	28.6	13	400-33733					40	226-31907	57	400-25797	75	B1613-512-R0H	91	400-25813		
S	1-1/4	31.8	14	400-33734					41	226-32004	58	400-25798	76	B1613-512-S0H	92	400-25814		
T	1-3/8	34.9							42	226-32103	59	400-25799	77	B1613-512-T0H	93	400-25815		
U	1-1/2	38.1							43	226-32202	60	400-25800	78	B1613-512-U0H	94	400-25816		
Stitch spec. 縫 仕 様	A	★																
	F	★																
	S	★																
	G	★																

Needle gauge size 針 幅		Feed Dog 送り 歯	
Code コード*	Needle gauge size		1.7
	inch	mm	Part No.
D	3/16	4.8	170 400-95291
F	1/4	6.4	171 400-94774
Stitch spec. 縫 仕 様	G ★		

Needle gauge size 針 幅		Feed Dog (Lower feed) 送り 歯 (下送り)				Needle clamp asm. 針 留 組				Throat plate 針 板		Throat plate (with Taping) 針 板 (テープ付)		Throat plate (Lower feed) 針 板 (下送り)						
Code コード*	Needle gauge size		Wire Type ワイヤタイプ		Hole Type スタイフ		Throat plate		Throat plate		Throat plate		Throat plate							
	inch	mm	No.	Part No.	No.	Part No.	No.	Part No.	No.	Part No.	No.	Part No.	No.	Part No.						
A	3/32	2.4			106	400-35875	125	101-47551	139	226-25008										
B	1/8	3.2	95	232-05107			107	400-26027	126	101-47650	140	226-25107	160	226-28002	167	228-45200				
C	5/32	4.0					108	400-26029	127	101-47759	141	226-25206	161	226-28101						
D	3/16	4.8	96	232-05305			109	400-26031	172	101-47858	142	226-25305	162	226-28200	168	228-45408				
E	7/32	5.6					110	400-26033	128	101-47957	144	226-25404	163	226-28309						
F	1/4	6.4	97	232-05503			111	400-26035	173	101-48054	145	226-25503	164	226-28408	169	228-45606				
G	9/32	7.1					112	400-26037	129	101-48153	147	226-25602	165	226-28507						
H	5/16	7.9					113	400-26039	174	101-48252	148	226-25701	166	226-28606						
K	3/8	9.5					114	400-26041	175	101-48351	149	226-25800								
W	7/16	11.1					115	400-26043	130	101-48450	150	226-25909								
L	1/2	12.7			102	400-62249	116	400-26045	131	101-48559	151	226-26006				98	400-62254			
M	5/8	15.9					117	400-26047	132	101-48658	152	226-26105								
N	3/4	19.1			103	400-62251	118	400-26049	133	101-48757	153	226-26204					99	400-62256		
P	7/8	22.2			104	400-62252	119	400-26051	134	101-48856	154	226-26303					100	400-62257		
Q	1	25.4			105	400-62253	120	400-26053	176	101-48955	155	226-26402					101	400-62258		
R	1-1/8	28.6					121	400-26055	135	101-49052	156	226-26501								
S	1-1/4	31.8					122	400-26057	136	101-49151	157	226-26600								
T	1-3/8	34.9					123	400-26059	137	101-49250	158	226-26709								
U	1-1/2	38.1					124	400-26061	138	101-49359	159	226-26808								
Stitch spec. 縫 仕 様	A	★																		
	F	★																		
	S	★																		
	G	★																		
下送り	★																			

REFNO	NOTE	PART NO	DESCRIPTION	品名	Qty
1		400-33714	FEED_DOG_TYPE_AA_3/32	送り歯AA_3/32	1
2		400-33715	FEED_DOG_TYPE_AA_1/8	送り歯AA_1/8	1
3		400-33716	FEED_DOG_TYPE_AA_5/32	送り歯AA_5/32	1
4		400-33718	FEED_DOG_TYPE_AA_3/16	送り歯AA_3/16	1
5		400-33720	FEED_DOG_TYPE_AA_1/4	送り歯AA_1/4	1
6		400-33722	FEED_DOG_TYPE_AA_9/32	送り歯AA_9/32	1
7		400-33723	FEED_DOG_TYPE_AA_5/16	送り歯AA_5/16	1
8		400-33724	FEED_DOG_TYPE_AA_3/8	送り歯AA_3/8	1
9		400-33727	FEED_DOG_TYPE_AA_1/2	送り歯AA_1/2	1
10		400-33729	FEED_DOG_TYPE_AA_3/4	送り歯AA_3/4	1
11		400-33731	FEED_DOG_TYPE_AA_7/8	送り歯AA_7/8	1
12		400-33732	FEED_DOG_TYPE_AA_1	送り歯AA_1	1
13		400-33733	FEED_DOG_TYPE_AA_1_1/8	送り歯AA_1_1/8	1
14		400-33734	FEED_DOG_TYPE_AA_1_1/4	送り歯AA_1_1/4	1
15		400-33683	FEED_DOG_TYPE_F_1/8	送り歯F_1/8	1
16		400-35884	FEED_DOG_TYPE_F_3/16	送り歯F_3/16	1
17		400-35885	FEED_DOG_TYPE_F_7/32	送り歯F_7/32	1
18		400-35886	FEED_DOG_TYPE_F_1/4	送り歯F_1/4	1
19		400-35887	FEED_DOG_TYPE_F_9/32	送り歯F_9/32	1
20		400-35888	FEED_DOG_TYPE_F_5/16	送り歯F_5/16	1
21		400-35883	FEED_DOG_TYPE_F_1/8	送り歯F_1/8	1
22		400-35884	FEED_DOG_TYPE_F_3/16	送り歯F_3/16	1
23		400-35885	FEED_DOG_TYPE_F_7/32	送り歯F_7/32	1
24		400-35886	FEED_DOG_TYPE_F_1/4	送り歯F_1/4	1
25		400-35887	FEED_DOG_TYPE_F_9/32	送り歯F_9/32	1
26		400-35888	FEED_DOG_TYPE_F_5/16	送り歯F_5/16	1
27		226-30206	FEED_DOG 5/32" (4.0MM)	送り歯5/32" (4.0MM)	1
28		226-30404	FEED_DOG 3/16" (4.8MM)	送り歯3/16" (4.8MM)	1
29		226-30503	FEED_DOG 7/32" (5.6MM)	送り歯7/32" (5.6MM)	1
30		226-30602	FEED_DOG 1/4" (6.4MM)	送り歯1/4" (6.4MM)	1
31		226-30800	FEED_DOG 9/32" (7.1MM)	送り歯9/32" (7.1MM)	1
32		226-30909	FEED_DOG 5/16" (7.9MM)	送り歯5/16" (7.9MM)	1
33		226-31008	FEED_DOG 3/8" (9.5MM)	送り歯3/8" (9.5MM)	1
34		226-31105	FEED_DOG 7/16" (11.1MM)	送り歯7/16" (11.1MM)	1
35		226-31303	FEED_DOG 1/2" (12.7MM)	送り歯1/2" (12.7MM)	1
36		226-31402	FEED_DOG 5/8" (15.9MM)	送り歯5/8" (15.9MM)	1
37		226-31501	FEED_DOG 3/4" (19.1MM)	送り歯3/4" (19.1MM)	1
38		226-31700	FEED_DOG 7/8" (22.6MM)	送り歯7/8" (22.6MM)	1
39		226-31808	FEED_DOG 1" (25.4MM)	送り歯1" (25.4MM)	1
40		226-31907	FEED_DOG 1 1/8" (28.6MM)	送り歯1 1/8" (28.6MM)	1
41		226-32004	FEED_DOG 1 1/4" (31.8MM)	送り歯1 1/4" (31.8MM)	1
42		226-32103	FEED_DOG 1 3/8" (34.9MM)	送り歯1 3/8" (34.9MM)	1
43		226-32202	FEED_DOG 1 1/2" (38.1MM)	送り歯1 1/2" (38.1MM)	1
44		400-25784	FEED_DOG_TYPE_SA_5/32	送り歯SA_5/32	1
45		400-25785	FEED_DOG_TYPE_SA_3/16	送り歯SA_3/16	1
46		400-25786	FEED_DOG_TYPE_SA_7/32	送り歯SA_7/32	1
47		400-25787	FEED_DOG_TYPE_SA_1/4	送り歯SA_1/4	1
48		400-25788	FEED_DOG_TYPE_SA_9/32	送り歯SA_9/32	1
49		400-25789	FEED_DOG_TYPE_SA_5/16	送り歯SA_5/16	1
50		400-25790	FEED_DOG_TYPE_SA_3/8	送り歯SA_3/8	1
51		400-25791	FEED_DOG_TYPE_SA_7/16	送り歯SA_7/16	1
52		400-25792	FEED_DOG_TYPE_SA_1/2	送り歯SA_1/2	1
53		400-25793	FEED_DOG_TYPE_SA_5/8	送り歯SA_5/8	1
54		400-25794	FEED_DOG_TYPE_SA_3/4	送り歯SA_3/4	1
55		400-25795	FEED_DOG_TYPE_SA_7/8	送り歯SA_7/8	1
56		400-25796	FEED_DOG_TYPE_SA_1	送り歯SA_1	1
57		400-25797	FEED_DOG_TYPE_SA_1_1/8	送り歯SA_1_1/8	1
58		400-25798	FEED_DOG_TYPE_SA_1_1/4	送り歯SA_1_1/4	1
59		400-25799	FEED_DOG_TYPE_SA_1_3/8	送り歯SA_1_3/8	1
60		400-25800	FEED_DOG_TYPE_SA_1_1/2	送り歯SA_1_1/2	1
61		B1613-512-ROH	FEED_DOG 1/8"	送り歯 1/8" (厚物)	1
62		B1613-512-COH	FEED_DOG 5/32"	送り歯 5/32" (厚物)	1
63		B1613-512-DOH	FEED_DOG 3/16"	送り歯 3/16" (厚物)	1
64		B1613-512-EOH	FEED_DOG 7/32"	送り歯 7/32" (厚物)	1
65		B1613-512-FOH	FEED_DOG 1/4"	送り歯 1/4" (厚物)	1
66		B1613-512-GOH	FEED_DOG 9/32"	送り歯 9/32" (厚物)	1
67		B1613-512-HOH	FEED_DOG 5/16"	送り歯 5/16" (厚物)	1
68		B1613-512-KOH	FEED_DOG 3/8"	送り歯 3/8" (厚物)	1
69		400-75311	FEED_DOG_TYPE_G_7/16	送り歯G仕様7/16"	1
70		B1613-512-LOH	FEED_DOG 1/2"	送り歯 1/2" (厚物)	1
71		B1613-512-MOH	FEED_DOG 5/8"	送り歯 5/8" (厚物)	1
72		B1613-512-NOH	FEED_DOG 3/4"	送り歯 3/4" (厚物)	1
73		B1613-512-POH	FEED_DOG 7/8"	送り歯 7/8" (厚物)	1
74		B1613-512-QOH	FEED_DOG 1"	送り歯 1" (厚物)	1
75		B1613-512-ROH	FEED_DOG 1 1/8"	送り歯 1 1/8" (厚物)	1
76		B1613-512-SOH	FEED_DOG 1 1/4"	送り歯 1 1/4" (厚物)	1
77		B1613-512-TOH	FEED_DOG 1 3/8"	送り歯 1 3/8" (厚物)	1
78		B1613-512-UOH	FEED_DOG 1 1/2"	送り歯 1 1/2" (厚物)	1
79		400-25801	FEED_DOG_TYPE_G_3/16	送り歯G 3/16"	1
80		400-25802	FEED_DOG_TYPE_G_7/32	送り歯G 7/32"	1
81		400-25803	FEED_DOG_TYPE_G_1/4	送り歯G 1/4"	1
82		400-25804	FEED_DOG_TYPE_G_9/32	送り歯G 9/32"	1
83		400-25805	FEED_DOG_TYPE_G_5/16	送り歯G 5/16"	1
84		400-25806	FEED_DOG_TYPE_G_3/8	送り歯G 3/8"	1
85		400-25807	FEED_DOG_TYPE_G_7/16	送り歯G 7/16"	1
86		400-25808	FEED_DOG_TYPE_G_1/2	送り歯G 1/2"	1
87		400-25809	FEED_DOG_TYPE_G_5/8	送り歯G 5/8"	1
88		400-25810	FEED_DOG_TYPE_G_3/4	送り歯G 3/4"	1
89		400-25811	FEED_DOG_TYPE_G_7/8	送り歯G 7/8"	1
90		400-25812	FEED_DOG_TYPE_G_1	送り歯G 1"	1
91		400-25813	FEED_DOG_TYPE_G_1_1/8	送り歯G 1 1/8"	1
92		400-25814	FEED_DOG_TYPE_G_1_1/4	送り歯G 1 1/4"	1
93		400-25815	FEED_DOG_TYPE_G_1_3/8	送り歯G 1 3/8"	1
94		400-25816	FEED_DOG_TYPE_G_1_1/2	送り歯G 1 1/2"	1
95		232-05107	FEED_DOG 1/8"	送り歯 1/8"	1
96		232-05305	FEED_DOG 3/16"	送り歯 3/16"	1
97		232-05503	FEED_DOG 1/4"	送り歯 1/4"	1
98		400-62254	THROAT_PLATE_1/2	針板 (1/2)	1
99		400-62256	THROAT_PLATE_3/4	針板 (3/4)	1
100		400-62257	THROAT_PLATE_7/8	針板 (7/8)	1
101		400-62258	THROAT_PLATE_1	針板 (1)	1
102		400-62249	FEED_DOG_1/2	送り歯 (1/2)	1
103		400-62251	FEED_DOG_3/4	送り歯 (3/4)	1
104		400-62252	FEED_DOG_7/8	送り歯 (7/8)	1
105		400-62253	FEED_DOG_1	送り歯 (1)	1
106		400-28075	ASSY_NEEDLE_CLAMP(S)3/32	針組 (3/32)	1
107		400-28027	ASSY_NEEDLE_CLAMP(S)1/8	針組 (1/8)	1
108		400-28029	ASSY_NEEDLE_CLAMP(S)3/32	針組 (5/32)	1
109		400-28031	ASSY_NEEDLE_CLAMP(S)1/4	針組 (3/16)	1
110		400-28033	ASSY_NEEDLE_CLAMP(S)7/32	針組 (7/32)	1
111		400-28035	ASSY_NEEDLE_CLAMP(S)1/2	針組 (1/4)	1
112		400-28037	ASSY_NEEDLE_CLAMP(S)9/32	針組 (9/32)	1
113		400-28039	ASSY_NEEDLE_CLAMP(S)5/8	針組 (5/16)	1
114		400-28041	ASSY_NEEDLE_CLAMP(S)3/4	針組 (3/8)	1
115		400-28043	ASSY_NEEDLE_CLAMP(S)7/8	針組 (7/16)	1
116		400-28045	ASSY_NEEDLE_CLAMP(S)1	針組 (1/2)	1
117		400-28047	ASSY_NEEDLE_CLAMP(S)9/8	針組 (5/8)	1
118		400-28049	ASSY_NEEDLE_CLAMP(S)5/4	針組 (3/4)	1
119		400-28051	ASSY_NEEDLE_CLAMP(S)7/4	針組 (7/8)	1
120		400-28053	ASSY_NEEDLE_CLAMP(S)11/4	針組 (11/8)	1
121		400-28055	ASSY_NEEDLE_CLAMP(S)1 1/2	針組 (1 1/2)	1
122		400-28057	ASSY_NEEDLE_CLAMP(S)1 3/4	針組 (1 1/4)	1
123		400-28059	ASSY_NEEDLE_CLAMP(S)1 7/8	針組 (1 3/8)	1
124		400-28061	ASSY_NEEDLE_CLAMP(S)1 1/2	針組 (1 1/2)	1
125		101-47551	NEEDLE_CLAMP_ASM_3/32"	針組 3/32組	1
126		101-47550	NEEDLE_CLAMP_ASM_1/8"	針組 1/8組	1
127		101-47559	NEEDLE_CLAMP_ASM_5/32"	針組 5/32組	1
128		101-47567	NEEDLE_CLAMP_ASM_7/32"	針組 7/32組	1
129		101-48153	NEEDLE_CLAMP_ASM_9/32"	針組 9/32組	1
130		101-48450	NEEDLE_CLAMP_ASM_7/16"	針組 7/16組	1
131		101-48559	NEEDLE_CLAMP_ASM_1/2"	針組 1/2組	1
132		101-48658	NEEDLE_CLAMP_ASM_5/8"	針組 5/8組	1
133		101-48757	NEEDLE_CLAMP_ASM_3/4"	針組 3/4組	1
134		101-48856	NEEDLE_CLAMP_ASM_7/8"	針組 7/8組	1
135		101-49052	NEEDLE_CLAMP_ASM_1-1/8"	針組 1-1/8組	1
136		101-49151	NEEDLE_CLAMP_ASM_1-1/4"	針組 1-1/4組	1
137		101-49250	NEEDLE_CLAMP_ASM_1-3/8"	針組 1-3/8組	1
138		101-49359	NEEDLE_CLAMP_ASM_1-1/2"	針組 1-1/2組	1
139		226-25008	THROAT_PLATE 3/32" (2.4MM)	針板 (送り歯) 3/32" (2.4MM)	1
140		226-25107	THROAT_PLATE 1/8" (3.2MM)	針板 (送り歯) 1/8" (3.2MM)	1
141		226-25206	THROAT_PLATE 5/32" (4MM)	針板 (送り歯) 5/32" (4MM)	1
142		226-25305	THROAT_PLATE 3/16" (4.8MM)	針板 (送り歯) 3/16" (4.8MM)	1
143		400-60298	THROAT_PLATE 3/16" (4.8MM)	針板 (送り歯) 3/16" (4.8MM)	1
144		226-25404	THROAT_PLATE 7/32" (5.6MM)	針板 (送り歯) 7/32" (5.6MM)	1
145		226-25503	THROAT_PLATE 1/4" (6.4MM)	針板 (送り歯) 1/4" (6.4MM)	1
146		400-94772	THROAT_PLATE 1/4	針板	1
147		226-25602	THROAT_PLATE 9/32" (7.1MM)	針板 (送り歯) 9/32" (7.1MM)	1
148		226-25701	THROAT_PLATE 5/16" (7.9MM)	針板 (送り歯) 5/16" (7.9MM)	1
149		226-25800	THROAT_PLATE 3/8" (9.5MM)	針板 (送り歯) 3/8" (9.5MM)	1
150		226-25909	THROAT_PLATE 7/16" (11.1MM)	針板 (送り歯) 7/16" (11.1MM)	1
151		226-26006	THROAT_PLATE 1/2" (12.7MM)	針板 (送り歯) 1/2" (12.7MM)	1
152		226-26105	THROAT_PLATE 5/8" (15.9MM)	針板 (送り歯) 5/8" (15.9MM)	1
153		226-26204	THROAT_PLATE 3/4" (19.1MM)	針板 (送り歯) 3/4" (19.1MM)	1
154		226-26303	THROAT_PLATE 7/8" (22.6MM)	針板 (送り歯) 7/8" (22.6MM)	1
155		226-26402	THROAT_PLATE 1" (25.4MM)	針板 (送り歯) 1" (25.4MM)	1
156		226-26501	THROAT_PLATE 1 1/8" (28.6MM)	針板 (送り歯) 1 1/8" (28.6MM)	1
157		226-26600	THROAT_PLATE 1 1/4" (31.8MM)	針板 (送り歯) 1 1/4" (31.8MM)	1
158		226-26709	THROAT_PLATE 1 3/8" (34.9MM)	針板 (送り歯) 1 3/8" (34.9MM)	1
159		226-26808	THROAT_PLATE 1 1/2" (38.1MM)	針板 (送り歯) 1 1/2" (38.1MM)	1
160		226-26902	THROAT_PLATE 1 5/8"	針板 (送り歯) 1 5/8"	1
161		226-28101	THROAT_PLATE 5/32"	テープ付用針板 (5/32")	1
162		226-28200	THROAT_PLATE 3/16"	テープ付用針板 (3/16")	1
163		226-28309	THROAT_PLATE 7/32"	テープ付用針板 (7/32")	1
164		226-28408	THROAT_PLATE 1/4"	テープ付用針板 (1/4")	1
165		226-28507	THROAT_PLATE 9/32"	テープ付用針板 (9/32")	1
166		226-28606	TAPPING_THROAT_PLATE 5/16"	テープ付用針板 (5/16")	1
167		228-45200	THROAT_PLATE (1/8)	針板 (1/8")	1
168		228-45408	THROAT_PLATE (3/16)	針板 (3/16")	1
169		228-45606	THROAT_PLATE (1/4)	針板 (1/4")	1
170		400-94774	FEED_DOG 3/16	送り歯 (送り歯) 3/16	1
171		400-94774	FEED_DOG 1/4	送り歯	1
172		101-47858	NEEDLE_CLAMP_ASM_3/16"	針組 3/16組	1
173		101-48054	NEEDLE_CLAMP_ASM_1/4"	針組 1/4組	1
174		101-48252	NEEDLE_CLAMP_ASM_5/16"	針組 5/16組	1
175		101-48351	NEEDLE_CLAMP_ASM_3/8"	針組 3/8組	1
176		101-48955	NEEDLE_CLAMP_ASM_1"	針組 1組	1

25. TABLE OF EXCHANGING GAUGE PARTS (FOR LH-3528A-7)

交換ゲージ部品一覧表 (LH-3528A-7 用)

Code コード	Needle gauge size 針 幅		Throat plate 針 板		Needle clamp asm. 針 留 組				Feed dog 送 り 歯								
	inch	mm	No.	Part No.	Wire Type ワイヤタイプ*		Hole Type 穴タイプ*		Option オフ' ション		Option オフ' ション		Option オフ' ション		Option オフ' ション		
A	3/32	2.4	—	—	19	400-35875	36	101-47551	—	—	—	—	—	—	—	—	
B	1/8	3.2	1	400-35881	20	400-26027	37	101-47650	52	400-61270	67	400-35890	—	—	97	400-53705	
C	5/32	4.0	2	400-25485	21	400-26029	38	101-47759	53	400-61271	68	400-25817	83	400-71911	—	—	
D	3/16	4.8	3 4	400-25490 ※ 400-95289	22	400-26031	164	101-47858	54	400-61272	69	400-25818	84	400-35891	98	400-25831	
E	7/32	5.6	5	400-25491	23	400-26033	39	101-47957	55	400-61273	70	400-25819	85	400-50009	99	400-25832	
F	1/4	6.4	6 7	400-25492 ※ 400-94773	24	400-26035	165	101-48054	56	400-61274	71	400-26715	86	400-35892	100	400-25833	
G	9/32	7.1	8	400-25493	25	400-26037	40	101-48153	57	400-61275	72	400-25820	87	400-50010	101	400-25834	
H	5/16	7.9	9	400-25494	158	400-26039	41	101-48252	58	400-61276	73	400-25821	88	400-50011	102	400-25835	
K	3/8	9.5	10	400-25495	26	400-26041	166	101-48351	59	400-61277	74	400-25822	89	400-35893	103	400-25836	
W	7/16	11.1	11	400-25496	27	400-26043	42	101-48450	—	—	75	400-25823	—	—	104	400-25837	
L	1/2	12.7	12	400-25498	28	400-26045	43	101-48559	60	400-61278	76	400-25824	90	400-35894	105	400-25838	
M	5/8	15.9	13	400-25499	29	400-26047	44	101-48658	61	400-61279	77	400-25825	91	400-71912	106	400-25839	
N	3/4	19.1	14	400-25500	30	400-26049	45	101-48757	62	400-61280	78	400-25826	92	400-35895	107	400-25840	
P	7/8	22.2	15	400-25502	31	400-26051	46	101-48856	63	400-61281	79	400-25827	93	400-71913	108	400-25841	
Q	1	25.4	16	400-25503	159	400-26053	47	101-48955	64	400-61282	80	400-25828	94	400-71914	109	400-25842	
R	1-1/8	28.6	17	400-25504	32	400-26055	48	101-49052	65	400-61283	81	400-25829	95	400-71915	110	400-25843	
S	1-1/4	31.8	18	400-25505	33	400-26057	49	101-49151	66	400-61284	82	400-25830	96	400-71916	111	400-25844	
T	1-3/8	34.9	—	—	34	400-26059	50	101-49250	—	—	—	—	—	—	—	—	
U	1-1/2	38.1	—	—	35	400-26061	51	101-49359	—	—	—	—	—	—	—	—	
Stitch spec. 縫 仕 様	A			★													
	F			★													
	S	★				★		★		★		★					
	G	※のみ ★				★		★						★		★	

Code コード	Needle gauge size 針 幅		Presser foot asm. 押 さ え (組)				Swivel guide Presser asm. スイブルガイド 押 さ え (組)		Sliding plate asm. (Left) 滑り板 (左) 組		Sliding plate asm. (Right) 滑り板 (右) 組		Sliding plate asm. (Left) 滑り板 (左) 組		Sliding plate asm. (Front) 滑り板 (前) 組		
	inch	mm	No.	Part No.	No.	Part No.	No.	Part No.	No.	Part No.	No.	Part No.	No.	Part No.	No.	Part No.	
B	1/8	3.2	112	400-35896	—	—	—	—	—	—	—	—	—	—	—	—	
C	5/32	4.0	113	400-35897	128	400-71909	—	—	—	—	—	—	—	—	—	—	
D	3/16	4.8	114	226-40353	129	228-16557	143	400-95293	—	—	—	—	—	—	—	—	
E	7/32	5.6	115	226-40452	130	228-16656	167	402-29461	—	—	—	—	—	—	—	—	
F	1/4	6.4	116	226-40551	131	228-16755	144	400-94776	145	400-25247	149	400-25235	153	400-51633	—	—	
G	9/32	7.1	117	226-40759	132	228-16854	168	402-29459	—	—	—	—	—	—	—	—	
H	5/16	7.9	118	226-40858	133	228-16953	—	—	—	—	—	—	—	—	—	—	
K	3/8	9.5	119	226-40957	134	228-17050	—	—	—	—	—	—	—	—	—	—	
W	7/16	11.1	120	226-41054	135	400-33941	—	—	—	—	—	—	—	—	—	—	
L	1/2	12.7	121	226-41252	136	228-17159	—	—	—	—	—	—	—	—	—	—	
M	5/8	15.9	122	226-41351	137	400-33945	—	—	146	400-25248	150	400-25236	154	400-45729	—	—	
N	3/4	19.1	123	226-41450	138	400-33947	—	—	—	—	—	—	—	—	—	—	
P	7/8	22.2	124	226-41658	139	400-33949	—	—	—	—	—	—	—	—	—	—	
Q	1	25.4	125	226-41757	140	400-33951	—	—	147	400-25249	151	400-25239	155	400-45730	—	—	
R	1-1/8	28.6	126	226-41856	141	400-33953	—	—	—	—	—	—	—	—	—	—	
S	1-1/4	31.8	127	226-41955	142	400-33955	—	—	148	400-25250	152	400-25240	156	400-45731	—	—	
T	1-3/8	34.9	160	226-42052	162	400-33957	—	—	—	—	—	—	—	—	—	—	
U	1-1/2	38.1	161	226-42151	163	400-33959	—	—	—	—	—	—	—	—	—	—	
Stitch spec. 縫 仕 様	S	★				★		★		Spec. common 仕 様 共 通		Spec. common 仕 様 共 通		Spec. common 仕 様 共 通		Spec. common 仕 様 共 通	
	G			★		★		★									

REFNO	NOTE	PART NO	DESCRIPTION	品名	Qty
1		400-25481	THROAT_PLATE_TRM-1/8	喉口封板 1/8	1
2		400-25485	THROAT_PLATE_TRM-5/32	喉口封板 5/32	1
3		400-25490	THROAT_PLATE_TRM-3/16	喉口封板 3/16	1
4		400-25499	THROAT_PLATE_TRM-3/8	封板 (喉口) 3/8	1
5		400-25491	THROAT_PLATE_TRM-7/32	喉口封板 7/32	1
6		400-25492	THROAT_PLATE_TRM-1/4	喉口封板 1/4	1
7		400-25473	THROAT_PLATE_TRM-1/4	封板喉口	1
8		400-25483	THROAT_PLATE_TRM-9/32	喉口封板 9/32	1
9		400-25484	THROAT_PLATE_TRM-5/16	喉口封板 5/16	1
10		400-25486	THROAT_PLATE_TRM-3/8	喉口封板 3/8	1
11		400-25498	THROAT_PLATE_TRM-7/16	喉口封板 7/16	1
12		400-25498	THROAT_PLATE_TRM-1/2	喉口封板 1/2	1
13		400-25499	THROAT_PLATE_TRM-5/8	喉口封板 5/8	1
14		400-25500	THROAT_PLATE_TRM-3/4	喉口封板 3/4	1
15		400-25502	THROAT_PLATE_TRM-7/8	喉口封板 7/8	1
16		400-25503	THROAT_PLATE_TRM-1	喉口封板 1	1
17		400-25504	THROAT_PLATE_TRM-1-1/8	喉口封板 1-1/8	1
18		400-25505	THROAT_PLATE_TRM-1-1/4	喉口封板 1-1/4	1
19		400-25875	ASSY_NEEDLE_CLAMP(3/32)	針筒組 (3/32)	1
20		400-26027	ASSY_NEEDLE_CLAMP(1/8)	針筒組 (1/8)	1
21		400-26029	ASSY_NEEDLE_CLAMP(5/32)	針筒組 (5/32)	1
22		400-26031	ASSY_NEEDLE_CLAMP(3/16)	針筒組 (3/16)	1
23		400-26033	ASSY_NEEDLE_CLAMP(7/32)	針筒組 (7/32)	1
24		400-26035	ASSY_NEEDLE_CLAMP(1/4)	針筒組 (1/4)	1
25		400-26037	ASSY_NEEDLE_CLAMP(9/32)	針筒組 (9/32)	1
26		400-26041	ASSY_NEEDLE_CLAMP(3/8)	針筒組 (3/8)	1
27		400-26043	ASSY_NEEDLE_CLAMP(7/16)	針筒組 (7/16)	1
28		400-26045	ASSY_NEEDLE_CLAMP(1/2)	針筒組 (1/2)	1
29		400-26047	ASSY_NEEDLE_CLAMP(5/8)	針筒組 (5/8)	1
30		400-26049	ASSY_NEEDLE_CLAMP(3/4)	針筒組 (3/4)	1
31		400-26051	ASSY_NEEDLE_CLAMP(7/8)	針筒組 (7/8)	1
32		400-26055	ASSY_NEEDLE_CLAMP(1-1/8)	針筒組 (1-1/8)	1
33		400-26057	ASSY_NEEDLE_CLAMP(1-1/4)	針筒組 (1-1/4)	1
34		400-26059	ASSY_NEEDLE_CLAMP(1-3/8)	針筒組 (1-3/8)	1
35		400-26061	ASSY_NEEDLE_CLAMP(1-1/2)	針筒組 (1-1/2)	1
36		101-47551	NEEDLE_CLAMP_ASM_3/32	針筒 3/32組	1
37		101-47650	NEEDLE_CLAMP_ASM_1/8	針筒 1/8組	1
38		101-47759	NEEDLE_CLAMP_ASM_5/32	針筒 5/32組	1
39		101-47957	NEEDLE_CLAMP_ASM_7/32	針筒 7/32組	1
40		101-48153	NEEDLE_CLAMP_ASM_9/32	針筒 9/32組	1
41		101-48282	NEEDLE_CLAMP_ASM_5/16	針筒 5/16組	1
42		101-48450	NEEDLE_CLAMP_ASM_7/16	針筒 7/16組	1
43		101-48559	NEEDLE_CLAMP_ASM_1/2	針筒 1/2組	1
44		101-48658	NEEDLE_CLAMP_ASM_5/8	針筒 5/8組	1
45		101-48757	NEEDLE_CLAMP_ASM_3/4	針筒 3/4組	1
46		101-48856	NEEDLE_CLAMP_ASM_7/8	針筒 7/8組	1
47		101-48955	NEEDLE_CLAMP_ASM_1	針筒 1組	1
48		101-49052	NEEDLE_CLAMP_ASM_1-1/8	針筒 1-1/8組	1
49		101-49151	NEEDLE_CLAMP_ASM_1-1/4	針筒 1-1/4組	1
50		101-49250	NEEDLE_CLAMP_ASM_1-3/8	針筒 1-3/8組	1
51		101-49359	NEEDLE_CLAMP_ASM_1-1/2	針筒 1-1/2組	1
52		400-61270	FEED_DOG_TYPE-S 1/8	送り歯床切刃 S 1/8	1
53		400-61271	FEED_DOG_TYPE-S 5/32	送り歯床切刃 S 5/32	1
54		400-61272	FEED_DOG_TYPE-S 3/16	送り歯床切刃 S 3/16	1
55		400-61273	FEED_DOG_TYPE-S 7/32	送り歯床切刃 S 7/32	1
56		400-61274	FEED_DOG_TYPE-S 1/4	送り歯床切刃 S 1/4	1
57		400-61275	FEED_DOG_TYPE-S 9/32	送り歯床切刃 S 9/32	1
58		400-61276	FEED_DOG_TYPE-S 5/16	送り歯床切刃 S 5/16	1
59		400-61277	FEED_DOG_TYPE-S 3/8	送り歯床切刃 S 3/8	1
60		400-61278	FEED_DOG_TYPE-S 1/2	送り歯床切刃 S 1/2	1
61		400-61279	FEED_DOG_TYPE-S 5/8	送り歯床切刃 S 5/8	1
62		400-61280	FEED_DOG_TYPE-S 3/4	送り歯床切刃 S 3/4	1
63		400-61281	FEED_DOG_TYPE-S 7/8	送り歯床切刃 S 7/8	1
64		400-61282	FEED_DOG_TYPE-S 1	送り歯床切刃 S 1	1
65		400-61283	FEED_DOG_TYPE-S 1 1/8	送り歯床切刃 S 1 1/8	1
66		400-61284	FEED_DOG_TYPE-S 1 1/4	送り歯床切刃 S 1 1/4	1
67		400-61285	FEED_DOG_TYPE-S 1 1/8	送り歯床切刃 S 1 1/8	1
68		400-25817	FEED_DOG_TYPE-S 5/32	送り歯床切刃 S 5/32	1
69		400-25818	FEED_DOG_TYPE-S 3/16	送り歯床切刃 S 3/16	1
70		400-25819	FEED_DOG_TYPE-S 7/32	送り歯床切刃 S 7/32	1
71		400-25815	FEED_DOG_TYPE-S 1/4	送り歯床切刃 S 1/4	1
72		400-25820	FEED_DOG_TYPE-S 9/32	送り歯床切刃 S 9/32	1
73		400-25821	FEED_DOG_TYPE-S 5/16	送り歯床切刃 S 5/16	1
74		400-25822	FEED_DOG_TYPE-S 3/8	送り歯床切刃 S 3/8	1
75		400-25823	FEED_DOG_TYPE-S 7/16	送り歯床切刃 S 7/16	1
76		400-25824	FEED_DOG_TYPE-S 1/2	送り歯床切刃 S 1/2	1
77		400-25825	FEED_DOG_TYPE-S 5/8	送り歯床切刃 S 5/8	1
78		400-25826	FEED_DOG_TYPE-S 3/4	送り歯床切刃 S 3/4	1
79		400-25827	FEED_DOG_TYPE-S 7/8	送り歯床切刃 S 7/8	1
80		400-25828	FEED_DOG_TYPE-S 1	送り歯床切刃 S 1	1
81		400-25829	FEED_DOG_TYPE-S 1 1/8	送り歯床切刃 S 1 1/8	1
82		400-25830	FEED_DOG_TYPE-S 1 1/4	送り歯床切刃 S 1 1/4	1
83		400-71911	FEED_DOG_TG_5/32	送り歯送り歯切刃 G 5/32	1
84		400-33891	FEED_DOG_TG_3/16	送り歯送り歯切刃 G 3/16	1
85		400-50009	FEED_DOG_TG_7/32	送り歯送り歯切刃 G 7/32	1
86		400-35882	FEED_DOG_TG_1/4	送り歯送り歯切刃 G 1/4	1
87		400-50010	FEED_DOG_TG_9/32	送り歯送り歯切刃 G 9/32	1
88		400-50011	FEED_DOG_TG_5/16	送り歯送り歯切刃 G 5/16	1
89		400-35893	FEED_DOG_TG_3/8	送り歯送り歯切刃 G 3/8	1
90		400-35894	FEED_DOG_TG_1/2	送り歯送り歯切刃 G 1/2	1
91		400-71912	FEED_DOG_TG_5/8	送り歯送り歯切刃 G 5/8	1
92		400-35895	FEED_DOG_TG_3/4	送り歯送り歯切刃 G 3/4	1
93		400-71913	FEED_DOG_TG_7/8	送り歯送り歯切刃 G 7/8	1
94		400-71914	FEED_DOG_TG_1	送り歯送り歯切刃 G 1	1
95		400-71915	FEED_DOG_TG_1-1/8	送り歯送り歯切刃 G 1-1/8	1
96		400-71916	FEED_DOG_TG_1-1/4	送り歯送り歯切刃 G 1-1/4	1
97		400-53705	FEED_DOG_TG_1-1/8	送り歯送り歯切刃 G 1-1/8	1
98		400-25831	FEED_DOG_TG_3/16	送り歯送り歯切刃 G 3/16	1
99		400-25832	FEED_DOG_TG_7/32	送り歯送り歯切刃 G 7/32	1
100		400-25833	FEED_DOG_TG_1/4	送り歯送り歯切刃 G 1/4	1
101		400-25834	FEED_DOG_TG_9/32	送り歯送り歯切刃 G 9/32	1
102		400-25835	FEED_DOG_TG_5/16	送り歯送り歯切刃 G 5/16	1
103		400-25836	FEED_DOG_TG_3/8	送り歯送り歯切刃 G 3/8	1
104		400-25837	FEED_DOG_TG_7/16	送り歯送り歯切刃 G 7/16	1
105		400-25838	FEED_DOG_TG_1/2	送り歯送り歯切刃 G 1/2	1
106		400-25839	FEED_DOG_TG_5/8	送り歯送り歯切刃 G 5/8	1
107		400-25840	FEED_DOG_TG_3/4	送り歯送り歯切刃 G 3/4	1
108		400-25841	FEED_DOG_TG_7/8	送り歯送り歯切刃 G 7/8	1
109		400-25842	FEED_DOG_TG_1	送り歯送り歯切刃 G 1	1
110		400-25843	FEED_DOG_TG_1-1/8	送り歯送り歯切刃 G 1-1/8	1
111		400-25844	FEED_DOG_TG_1-1/4	送り歯送り歯切刃 G 1-1/4	1
112		400-35896	PRESSER FOOT ASM_1/8	先期自由押込 (脚) 1/8	1
113		400-35897	PRESSER FOOT ASM_5/32	先期自由押込 (脚) 5/32	1
114		228-40353	PRESSER FOOT ASM_3/16(4.8MM)	先期自由押込 (脚) 3/16" (4.8MM)	1
115		228-40452	PRESSER FOOT ASM_7/32(5.6MM)	先期自由押込 (脚) 7/32" (5.6MM)	1
116		228-40551	PRESSER FOOT ASM_1/4(6.4MM)	先期自由押込 (脚) 1/4" (6.4MM)	1
117		228-40759	PRESSER FOOT ASM_9/32(7.1MM)	先期自由押込 (脚) 9/32" (7.1MM)	1
118		228-40858	PRESSER FOOT ASM_5/16(7.9MM)	先期自由押込 (脚) 5/16" (7.9MM)	1
119		228-40957	PRESSER FOOT ASM_3/8(9.5MM)	先期自由押込 (脚) 3/8" (9.5MM)	1
120		228-41054	PRESSER FOOT ASM_7/16(11.1MM)	先期自由押込 (脚) 7/16" (11.1MM)	1
121		228-41252	PRESSER FOOT ASM_1/2(12.7MM)	先期自由押込 (脚) 1/2" (12.7MM)	1
122		228-41351	PRESSER FOOT ASM_5/8(15.9MM)	先期自由押込 (脚) 5/8" (15.9MM)	1
123		228-41450	PRESSER FOOT ASM_3/4(19.1MM)	先期自由押込 (脚) 3/4" (19.1MM)	1
124		228-41658	PRESSER FOOT ASM_7/8(22.0MM)	先期自由押込 (脚) 7/8" (22.0MM)	1
125		228-41757	PRESSER FOOT ASM_1(25.4MM)	先期自由押込 (脚) 1" (25.4MM)	1
126		228-41856	PRESSER FOOT ASM_1.1(28.0MM)	先期自由押込 (脚) 1.1" (28.0MM)	1
127		228-41955	PRESSER FOOT ASM_1.1(31.0MM)	先期自由押込 (脚) 1.1" (31.0MM)	1
128		400-71909	PRESSER_FOOT_ASM_G_5/32	先期自由押込 G (脚) 5/32	1
129		228-18557	TIP-DIVIDED PRESSER ASM_3/16	先期自由押込 2.4 (脚) 3/16"	1
130		228-18556	TIP-DIVIDED PRESSER ASM_7/32	先期自由押込 2.4 (脚) 7/32"	1
131		228-18555	PRESSER FOOT ASM_1/4	先期自由押込 2.4 (脚) 1/4"	1
132		228-18854	TIP-DIVIDED PRESSER ASM_9/32	先期自由押込 2.4 (脚) 9/32"	1
133		228-18953	TIP-DIVIDED PRESSER ASM_5/16	先期自由押込 2.4 (脚) 5/16"	1
134		228-17050	PRESSER FOOT ASM_D#2 3/8	先期自由押込 2.4 (脚) 3/8"	1
135		400-33941	TIP-DIVIDED PRESSER ASM_7/16	先期自由押込 2.4 (脚) 7/16"	1
136		228-17159	PRESSER FOOT ASM_D#2 4 1/2	先期自由押込 2.4 (脚) 1/2"	1
137		400-33945	TIP-DIVIDED PRESSER ASM_5/8	先期自由押込 2.4 (脚) 5/8"	1
138		400-33947	TIP-DIVIDED PRESSER ASM_3/4	先期自由押込 2.4 (脚) 3/4"	1
139		400-33949	TIP-DIVIDED PRESSER ASM_7/8	先期自由押込 2.4 (脚) 7/8"	1
140		400-33951	TIP-DIVIDED PRESSER ASM_1	先期自由押込 2.4 (脚) 1"	1
141		400-33953	TIP-DIVIDED PRESSER ASM_1 1/8	先期自由押込 2.4 (脚) 1-1/8"	1
142		400-33955	TIP-DIVIDED PRESSER ASM_1 1/4	先期自由押込 2.4 (脚) 1-1/4"	1
143	#01	400-92583	ASSY_PRESSER_FOOT_G3/16	スライルガイ押込 G 3/16"	1
144	#01	400-94778	ASSY_PRESSER_FOOT_G1/4	スライルガイ押込 G 1/4"	1
145		400-25247	ASSY_SLIDE_PLATE-L-A	喉口の滑り板-左-A-組	1
146		400-25248	ASSY_SLIDE_PLATE-L-B	喉口の滑り板-左-B-組	1
147		400-25249	ASSY_SLIDE_PLATE-L-C	喉口の滑り板-左-C-組	1
148		400-25250	ASSY_SLIDE_PLATE-L-D	喉口の滑り板-左-D-組	1
149		400-25235	ASSY_SLIDE_PLATE-R-A	喉口の滑り板-右-A-組	1
150		400-25236	ASSY_SLIDE_PLATE-R-B	喉口の滑り板-右-B-組	1
151		400-25239	ASSY_SLIDE_PLATE-R-C	喉口の滑り板-右-C-組	1
152		400-25240	ASSY_SLIDE_PLATE-R-D	喉口の滑り板-右-D-組	1
153		400-51633	ASSY_SLIDE_PLATE-L	滑り板左	1
154		400-45732	ASSY_SLIDE_PLATE-R	滑り板右	1
155		400-45730	ASSY_SLIDE_PLATE-L-C	滑り板左	1
156		400-45731	ASSY_SLIDE_PLATE-L-D	滑り板左	1
157		400-42880	ASSY_SLIDE_PLATE-F	滑り板両側付付組	1
158		400-26039	ASSY_NEEDLE_CLAMP(5/16)	針筒組 (5/16)	1
159		400-26053	ASSY_NEEDLE_CLAMP(1)	針筒組 (1)	1
160		228-42052	PRESSER FOOT ASM_1	先期自由押込 (脚)	1
161		228-42151	PRESSER FOOT ASM_1	先期自由押込 (脚)	1
162		400-33957	TIP-DIVIDED PRESSER_ASM_1_3/8	先期自由押込 (脚) 1-3/8"	1
163		400-33959	TIP-DIVIDED PRESSER_ASM_1_1/2	先期自由押込 (脚) 1-1/2"	1
164		101-47658	NEEDLE_CLAMP_ASM_3/16	針筒組 3/16組	1
165		101-48054	NEEDLE_CLAMP_ASM_1/4	針筒組 1/4組	1
166		101-48351	NEEDLE_CLAMP_ASM_3/8	針筒組 3/8組	1
167	#02	402-29461	ASSY_PRESSER_FOOT_G3/16	スライルガイ押込 G 3/16"	1
168	#02	402-29459	ASSY_PRESSER_FOOT_G_1/4	スライルガイ押込 G 1/4"	1



NOTE(注記)





#01_EDGE 3mm
#02_EDGE 2mm



コバ 3mm
コバ 2mm

26. TABLE OF EXCHANGING GAUGE PARTS (FOR LH-3568A)

交換ゲージ部品一覧表 (LH-3568A 用)

Needle gauge size 針 幅		Needle clamp asm. (for DP5) 針 留 組 (DP5用)										Sliding plate asm. (Left) 滑り板 (左) 組		Sliding plate asm. (Front) 滑り板 (前) 組	
Code コード		Needle clamp asm. (Left) 針留 (左) 組		Needle clamp asm. (Right) 針留 (右) 組		Needle clamp asm. (Left) 針留 (左) 組		Needle clamp asm. (Right) 針留 (右) 組							
		(Option オフ'ション)		(Option オフ'ション)		(Hole Type 穴タイプ)		(Hole Type 穴タイプ)		(Option オフ'ション)					
	inch	mm	No.	Part No.	No.	Part No.	No.	Part No.	No.	Part No.	No.	Part No.	No.	Part No.	
B	1/8	3.2	1	400-35761	14	400-35771	27	B1402-528-BA0-A	27	B1402-528-BA0-A	51	400-51633	54	400-42874	
C	5/32	4.0	2	400-35762	15	400-35772	28	B1402-528-CA0-A	28	B1402-528-CA0-A					
D	3/16	4.8	3	B1402-528-DAL-A	16	B1402-528-DAR-A	29	B1402-528-DAL-A	40	B1402-528-DAR-A					
E	7/32	5.6	4	B1402-528-EAL	17	B1402-528-EAR	30	B1402-528-EAL	41	B1402-528-EAR					
F	1/4	6.4	5	B1402-528-FAL-A	18	B1402-528-FAR-A	31	B1402-528-FAL-A	42	B1402-528-FAR-A					
G	9/32	7.1	6	400-35765	19	400-35775	32	B1402-528-GAL	43	B1402-528-GAR					
H	5/16	7.9	7	400-35766	20	400-35776	33	B1402-528-HAL-A	44	B1402-528-HAR-A					
K	3/8	9.5	8	B1402-528-KAL-A	21	B1402-528-KAR-A	34	B1402-528-KAL-A	45	B1402-528-KAR-A					
L	1/2	12.7	9	400-35768	22	400-35778	35	B1402-528-LAL	46	B1402-528-LAR					
M	5/8	15.9	10	400-35769	23	400-35779	36	B1402-528-MAL	47	B1402-528-MAR					
N	3/4	19.1	11	400-35770	24	400-35780	37	B1402-528-NAL	48	B1402-528-NAR					
P	7/8	22.2	12	400-71917	25	400-71919	38	B1402-528-PAL	49	B1402-528-PAR					
Q	1	25.4	13	400-71921	26	400-71923	39	B1402-528-QAL	50	B1402-528-QAR					
Stitch spec. 縫 仕 様	S							★	★	★	★				



Needle gauge size 針 幅		Needle clamp asm. (for DP17) 針 留 組 (DP17用)										Throat plate 針 板		Sliding plate asm. (Left) 滑り板 (左) 組		Sliding plate asm. (Right) 滑り板 (右) 組	
Code コード		Needle clamp asm. (Left) 針留 (左) 組		Needle clamp asm. (Right) 針留 (右) 組		Needle clamp asm. (Left) 針留 (左) 組		Needle clamp asm. (Right) 針留 (右) 組									
		Option オフ'ション		Option オフ'ション		Option オフ'ション		Option オフ'ション									
	inch	mm	No.	Part No.	No.	Part No.	No.	Part No.	No.	Part No.	No.	Part No.	No.	Part No.			
B	1/8	3.2	55	400-35877	67	400-35878	79	B1402-526-BA0-A	79	B1402-526-BA0-A	101	226-25107	117	226-01058	120	226-00555	
C	5/32	4.0	56	400-26063	68	400-26084	80	B1402-526-CA0-A	80	B1402-526-CA0-A	102	226-25206					
D	3/16	4.8	57	400-26065	69	400-26086	81	B1402-526-DAL-A	91	B1402-526-DAR-A	103	400-72338					
E	7/32	5.6	58	400-26067	70	400-26088	82	102-28559	92	102-28567	104	226-25305					
F	1/4	6.4	59	400-26069	71	400-26090	83	B1402-526-FAL-A	93	B1402-526-FAR-A	105	400-95288					
G	9/32	7.1	60	400-26070	72	400-26091	84	B1402-526-GAL-A	94	B1402-526-GAR-A	106	226-25404					
H	5/16	7.9	61	400-26072	73	400-26093	85	B1402-526-HAL-A	95	B1402-526-HAR-A	107	226-25503					
K	3/8	9.5	62	400-26074	74	400-26095	86	B1402-526-KAL-A	96	B1402-526-KAR-A	108	400-94772					
L	1/2	12.7	63	400-26076	75	400-26097	87	B1402-526-LAL-A	97	B1402-526-LAR-A	109	226-25602					
M	5/8	15.9	64	400-26078	76	400-26099	88	102-28856	98	102-28864	110	226-25701					
N	3/4	19.1	65	400-26080	77	400-26101	89	102-28955	99	102-28963	111	226-25800					
P	7/8	22.2									112	226-26006					
Q	1	25.4	66	400-26082	78	400-26103	90	102-29151	100	102-29169	113	226-26105					
Stitch spec. 縫 仕 様	S							★	★	★	★	★	★				



Needle gauge size 針 幅		Feed Dog 送 り 歯										Presser foot asm. 押 さ え (組)				Swivel guide Presser asm. スイブ'ルガイド 押さえ (組)		
Code コード		Option オフ'ション		Option オフ'ション		Option オフ'ション		Option オフ'ション		Option オフ'ション		(Tip-divided) (移動式先割れ)		(Tip-divided) (移動式先割れ)				
		φ1.9		φ1.7		φ2.2		φ2.2mm		φ2.4		2.0mm		2.4mm				
	inch	mm	No.	Part No.	No.	Part No.	No.	Part No.	No.	Part No.	No.	Part No.	No.	Part No.	No.	Part No.		
B	1/8	3.2										171	400-35896					
C	5/32	4.0	123	226-30206	136	400-25784	148	B1613-512-C0H				172	400-35897	184	400-71909			
D	3/16	4.8	124	226-30404	137	400-25785	149	B1613-512-D0H	160	400-25801	197	400-95291	173	226-40353	185	228-16557	196	400-95293
E	7/32	5.6	125	226-30503	138	400-25786	150	B1613-512-E0H	161	400-25802			174	226-40452	186	228-16656	199	402-29461
F	1/4	6.4	126	226-30602	139	400-25787	151	B1613-512-F0H	162	400-25803	198	400-94774	175	226-40551	187	228-16755	135	400-94776
G	9/32	7.1	127	226-30800	140	400-25788	152	B1613-512-G0H	163	400-25804			176	226-40759	188	228-16854	200	402-29459
H	5/16	7.9	128	226-30909	141	400-25789	153	B1613-512-H0H	164	400-25805			177	226-40858	189	228-16953		
K	3/8	9.5	129	226-31006	142	400-25790	154	B1613-512-K0H	165	400-25806			178	226-40957	190	228-17050		
L	1/2	12.7	130	226-31303	143	400-25792	155	B1613-512-L0H	166	400-25808			179	226-41252	191	228-17159		
M	5/8	15.9	131	226-31402	144	400-25793	156	B1613-512-M0H	167	400-25809			180	226-41351	192	400-33945		
N	3/4	19.1	132	226-31501	145	400-25794	157	B1613-512-N0H	168	400-25810			181	226-41450	193	400-33947		
P	7/8	22.2	133	226-31709	146	400-25795	158	B1613-512-P0H	169	400-25811			182	226-41658	194	400-33949		
Q	1	25.4	134	226-31808	147	400-25796	159	B1613-512-Q0H	170	400-25812			183	226-41757	195	400-33951		
Stitch spec. 縫 仕 様	S			★		★		★		★		★		★		★		



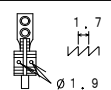
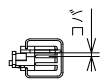

REFNO	NOTE	PART NO	DESCRIPTION	品名	Qty
1		400-3571	ASSY_NEEDLE_CLAMP_L(118)	針線圧 (1/8)	1
2		400-3572	ASSY_NEEDLE_CLAMP_L(5/32)	針線圧 (5/32)	1
3		B1402-528-DAL-A	NEEDLE_CLAMP_ASM_LEFT_3/16	針線圧 3/16組	1
4		B1402-528-FAL-A	NEEDLE_CLAMP_ASM_RIGHT_7/32	針線圧 7/32組	1
5		B1402-528-FAL-A	NEEDLE_CLAMP_ASM_RIGHT_1/4	針線圧 1/4組	1
6		400-3573	ASSY_NEEDLE_CLAMP_L(1/2)	針線圧 (1/2)	1
7		400-3576	ASSY_NEEDLE_CLAMP_L(5/16)	針線圧 (5/16)	1
8		B1402-528-KAL-A	NEEDLE_CLAMP_ASM_3/8	針線圧 3/8組	1
9		400-3576	ASSY_NEEDLE_CLAMP_L(1/2)	針線圧 (1/2)	1
10		400-3579	ASSY_NEEDLE_CLAMP_R(5/8)	針線圧 (5/8)	1
11		400-3579	ASSY_NEEDLE_CLAMP_R(7/8)	針線圧 (7/8)	1
12		400-7117	ASSY_NEEDLE_CLAMP_L_7/8	針線 (圧) 7/8	1
13		400-7121	ASSY_NEEDLE_CLAMP_L_1	針線 (圧) 1	1
14		400-3577	ASSY_NEEDLE_CLAMP_R(1/8)	針線 (圧) 1/8	1
15		400-3572	ASSY_NEEDLE_CLAMP_L(5/32)	針線圧 (5/32)	1
16		B1402-528-DAR-A	NEEDLE_CLAMP_ASM_RIGHT_3/16	針線圧 3/16組	1
17		B1402-528-EAR	NEEDLE_CLAMP_ASM_1/4	針線圧 1/4組	1
18		B1402-528-FARA	ASSY_NEEDLE_CLAMP_R(5/32)	針線圧 (5/32)	1
19		400-3575	ASSY_NEEDLE_CLAMP_R(1/2)	針線圧 (1/2)	1
20		400-3578	ASSY_NEEDLE_CLAMP_R(5/16)	針線圧 (5/16)	1
21		B1402-528-KARA	NEEDLE_CLAMP_ASM_1/2	針線圧 1/2組	1
22		400-3578	ASSY_NEEDLE_CLAMP_R(1/2)	針線圧 (1/2)	1
23		400-3579	ASSY_NEEDLE_CLAMP_R(5/8)	針線圧 (5/8)	1
24		400-3579	ASSY_NEEDLE_CLAMP_R(7/8)	針線圧 (7/8)	1
25		400-7119	ASSY_NEEDLE_CLAMP_R_7/8	針線 (圧) 7/8	1
26		400-7122	ASSY_NEEDLE_CLAMP_R_1	針線 (圧) 1	1
27		B1402-528-BA0-A	NEEDLE_CLAMP_ASM_1/8	針線 1/8組	1
28		B1402-528-CA0-A	NEEDLE_CLAMP_ASM_5/32	針線 5/32組	1
29		B1402-528-DAL-A	NEEDLE_CLAMP_ASM_LEFT_3/16	針線 3/16組	1
30		B1402-528-EAL	NEEDLE_CLAMP_ASM_7/32	針線 7/32組	1
31		B1402-528-FAL-A	NEEDLE_CLAMP_ASM_RIGHT_1/4	針線 1/4組	1
32		B1402-528-GAL	NEEDLE_CLAMP_ASM_LEFT	針線圧 1/4組	1
33		B1402-528-KAL-A	NEEDLE_CLAMP_ASM_5/16	針線圧 5/16組	1
34		B1402-528-KAL-A	NEEDLE_CLAMP_ASM_3/8	針線圧 3/8組	1
35		B1402-528-LAL	NEEDLE_CLAMP_ASM_LEFT_1/2	針線圧 1/2組	1
36		B1402-528-MAM	NEEDLE_CLAMP_ASM_LEFT_1/8	針線圧 1/8組	1
37		B1402-528-NAL	NEEDLE_CLAMP_ASM_LEFT_3/4	針線圧 3/4組	1
38		B1402-528-PAL	NEEDLE_CLAMP_ASM_LEFT_7/8	針線 (圧) 7/8	1
39		B1402-528-QAL	NEEDLE_CLAMP_ASM_LEFT_1"	針線 (圧) 1	1
40		B1402-528-DAR-A	NEEDLE_CLAMP_ASM_RIGHT_3/16	針線圧 3/16組	1
41		B1402-528-EAR	NEEDLE_CLAMP_ASM_7/32	針線圧 7/32組	1
42		B1402-528-FARA	NEEDLE_CLAMP_ASM_1/4	針線圧 1/4組	1
43		B1402-528-GAR	NEEDLE_CLAMP_ASM_RIGHT	針線圧	1
44		B1402-528-HARA	NEEDLE_CLAMP_ASM_5/16	針線圧 5/16組	1
45		B1402-528-KARA	NEEDLE_CLAMP_ASM_3/8	針線圧 3/8組	1
46		B1402-528-LAR	NEEDLE_CLAMP_ASM_RIGHT_1/2	針線圧 1/2組	1
47		B1402-528-MAR	NEEDLE_CLAMP_ASM_RIGHT_1/8	針線圧 1/8組	1
48		B1402-528-NAR	NEEDLE_CLAMP_ASM_RIGHT_3/4	針線圧 3/4組	1
49		B1402-528-PAR	NEEDLE_CLAMP_ASM_RIGHT_7/8	針線 (圧) 7/8	1
50		B1402-528-QAR	NEEDLE_CLAMP_ASM_RIGHT_1"	針線 (圧) 1	1
51		400-1833	ASSY_SLIDE_PLATE_L	スライドプレート組	1
52		400-4570	ASSY_SLIDE_PLATE_LB	スライドプレート組	1
53		400-4570	ASSY_SLIDE_PLATE_LC	スライドプレート組	1
54		400-4571	ASSY_SLIDE_PLATE_L STANDAR	スライドプレート組	1
55		400-3587	ASSY_NEEDLE_CLAMP_L(1/8)	針線圧 (1/8)	1
56		400-3583	ASSY_NEEDLE_CLAMP_L(5/32)	針線圧 (5/32)	1
57		400-3585	ASSY_NEEDLE_CLAMP_L(1/4)	針線圧 (1/4)	1
58		400-3587	ASSY_NEEDLE_CLAMP_L(7/32)	針線圧 (7/32)	1
59		400-3589	ASSY_NEEDLE_CLAMP_L(1/2)	針線圧 (1/2)	1
60		400-3570	ASSY_NEEDLE_CLAMP_L(5/32)	針線圧 (5/32)	1
61		400-3572	ASSY_NEEDLE_CLAMP_L(1/8)	針線圧 (1/8)	1
62		400-3573	ASSY_NEEDLE_CLAMP_L(1/4)	針線圧 (1/4)	1
63		400-3575	ASSY_NEEDLE_CLAMP_L(1/2)	針線圧 (1/2)	1
64		400-3578	ASSY_NEEDLE_CLAMP_L(5/16)	針線圧 (5/16)	1
65		400-3583	ASSY_NEEDLE_CLAMP_L(1/4)	針線圧 (1/4)	1
66		400-3585	ASSY_NEEDLE_CLAMP_L(1/2)	針線圧 (1/2)	1
67		400-3587	ASSY_NEEDLE_CLAMP_L(7/32)	針線圧 (7/32)	1
68		400-3589	ASSY_NEEDLE_CLAMP_L(1/2)	針線圧 (1/2)	1
69		400-3583	ASSY_NEEDLE_CLAMP_L(1/4)	針線圧 (1/4)	1
70		400-3585	ASSY_NEEDLE_CLAMP_L(1/2)	針線圧 (1/2)	1
71		400-3579	ASSY_NEEDLE_CLAMP_R(5/8)	針線圧 (5/8)	1
72		400-3579	ASSY_NEEDLE_CLAMP_R(7/8)	針線圧 (7/8)	1
73		400-3583	ASSY_NEEDLE_CLAMP_R(1/4)	針線圧 (1/4)	1
74		400-3585	ASSY_NEEDLE_CLAMP_R(1/2)	針線圧 (1/2)	1
75		400-3587	ASSY_NEEDLE_CLAMP_R(7/32)	針線圧 (7/32)	1
76		400-3579	ASSY_NEEDLE_CLAMP_R(5/8)	針線圧 (5/8)	1
77		400-2611	ASSY_NEEDLE_CLAMP_R(1/4)	針線圧 (1/4)	1
78		400-2613	ASSY_NEEDLE_CLAMP_R(1/2)	針線圧 (1/2)	1
79		B1402-528-BA0-A	NEEDLE_CLAMP_ASM_1/8	針線 1/8組	1
80		B1402-528-CA0-A	NEEDLE_CLAMP_ASM_5/32	針線 5/32組	1
81		B1402-528-DAL-A	NEEDLE_CLAMP_ASM_LEFT_3/16	針線 3/16組	1
82		102-2856	NEEDLE_CLAMP_ASM_LEFT_7/32	針線 7/32組	1
83		B1402-528-FAL-A	NEEDLE_CLAMP_ASM_LEFT_1/4	針線 1/4組	1
84		B1402-528-GAL-A	NEEDLE_CLAMP_ASM_LEFT_5/16	針線 5/16組	1
85		B1402-528-HAL-A	NEEDLE_CLAMP_ASM_LEFT_3/8	針線 3/8組	1
86		B1402-528-KAL-A	NEEDLE_CLAMP_ASM_LEFT_1/2	針線 1/2組	1
87		102-2856	NEEDLE_CLAMP_ASM_LEFT_7/32	針線 7/32組	1
88		102-2856	NEEDLE_CLAMP_ASM_LEFT_5/8	針線 5/8組	1
89		102-2855	NEEDLE_CLAMP_ASM_LEFT_3/4	針線 3/4組	1
90		102-2915	NEEDLE_CLAMP_ASM_LEFT_1"	針線 1"組	1
91		B1402-528-DARA	NEEDLE_CLAMP_ASM_RIGHT_3/16	針線 3/16組	1
92		102-2861	NEEDLE_CLAMP_ASM_RIGHT_7/32	針線 7/32組	1
93		B1402-528-FARA	NEEDLE_CLAMP_ASM_RIGHT_1/4	針線 1/4組	1
94		B1402-528-GARA	NEEDLE_CLAMP_ASM_RIGHT_5/16	針線 5/16組	1
95		B1402-528-HARA	NEEDLE_CLAMP_ASM_RIGHT_3/8	針線 3/8組	1
96		B1402-528-KARA	NEEDLE_CLAMP_ASM_RIGHT_1/2	針線 1/2組	1
97		B1402-528-LARA	NEEDLE_CLAMP_ASM_RIGHT_1/8	針線 1/8組	1
98		102-2884	NEEDLE_CLAMP_ASM_RIGHT_5/8	針線 5/8組	1
99		102-2863	NEEDLE_CLAMP_ASM_RIGHT_3/4	針線 3/4組	1
100		102-2916	NEEDLE_CLAMP_ASM_RIGHT_1"	針線 1"組	1
101		228-2507	THROAT_PLATE_1P(3.2MM)	喉板 (厚さ) 1P (3.2MM)	1
102		228-2506	THROAT_PLATE_5P(4MM)	喉板 (厚さ) 5P (4MM)	1
103		400-7238	THROAT_PLATE_G_5/32	喉板 (厚さ) 5/32 (4.0MM)	1
104		228-2535	THROAT_PLATE_3/16(4.8MM)	喉板 (厚さ) 3/16 (4.8MM)	1
105		400-6286	THROAT_PLATE_3/16(4.8MM)	喉板 (厚さ) 3/16 (4.8MM)	1
106		228-2544	THROAT_PLATE_7/32(5.5MM)	喉板 (厚さ) 7/32 (5.5MM)	1
107		228-2505	THROAT_PLATE_1/4(6.4MM)	喉板 (厚さ) 1/4 (6.4MM)	1
108		400-4472	THROAT_PLATE_1/4	喉板 1/4	1
109		228-2502	THROAT_PLATE_9/32(7.1MM)	喉板 (厚さ) 9/32 (7.1MM)	1
110		228-2571	THROAT_PLATE_5/8(7.9MM)	喉板 (厚さ) 5/8 (7.9MM)	1
111		228-2580	THROAT_PLATE_3/4(9.5MM)	喉板 (厚さ) 3/4 (9.5MM)	1
112		228-2609	THROAT_PLATE_1(12.7MM)	喉板 (厚さ) 1" (12.7MM)	1
113		228-2610	THROAT_PLATE_5/8(15.9MM)	喉板 (厚さ) 5/8 (15.9MM)	1
114		228-2624	THROAT_PLATE_3/4(19.1MM)	喉板 (厚さ) 3/4 (19.1MM)	1
115		228-2630	THROAT_PLATE_1(25.4MM)	喉板 (厚さ) 1" (25.4MM)	1
116		228-2642	THROAT_PLATE_1(25.4MM)	喉板 (厚さ) 1" (25.4MM)	1
117		228-2658	RED_SLIDER_PLATE_A_ASM	赤スライダープレート組	1
118		228-2617	LEFT_SLIDER_PLATE_B_ASM	左スライダープレート組	1
119		228-2616	RED_SLIDER_PLATE_C_ASM	赤スライダープレート組	1
120		228-2656	RED_SLIDER_PLATE_A_ASM	赤スライダープレート組	1
121		228-3064	RIGHT_SLIDER_PLATE_B_ASM	右スライダープレート組	1
122		228-3058	FEED_DOG_RIGHT_ASM_C	送り歯 (右) 組 C	1
123		228-3036	FEED_DOG_5/32(4.0MM)	送り歯 5/32 (4.0MM)	1
124		228-3044	FEED_DOG_3/16(4.8MM)	送り歯 3/16 (4.8MM)	1
125		228-3003	FEED_DOG_7/32(5.5MM)	送り歯 7/32 (5.5MM)	1
126		228-3062	FEED_DOG_1/4	送り歯 1/4 (6.4MM)	1
127		228-3069	FEED_DOG_9/32(7.1MM)	送り歯 9/32 (7.1MM)	1
128		228-3000	FEED_DOG_5/8(7.9MM)	送り歯 5/8 (7.9MM)	1
129		228-3106	FEED_DOG_3/4(9.5MM)	送り歯 3/4 (9.5MM)	1
130		228-3130	FEED_DOG_1(12.7MM)	送り歯 1" (12.7MM)	1
131		228-3142	FEED_DOG_5/8(15.9MM)	送り歯 5/8 (15.9MM)	1
132		228-3151	FEED_DOG_3/4(19.1MM)	送り歯 3/4 (19.1MM)	1
133		228-3109	FEED_DOG_7/8(22.9MM)	送り歯 7/8 (22.9MM)	1
134		228-3188	FEED_DOG_1(25.4MM)	送り歯 1" (25.4MM)	1
135		400-8478	ASSY_PRESSER_FOOT_014	スプレッサー足組 014	1
136		400-2574	FEED_DOG_TYPE_SA_5/32	送り歯 SA 5/32	1
137		400-2576	FEED_DOG_TYPE_SA_3/16	送り歯 SA 3/16	1
138		400-2578	FEED_DOG_TYPE_SA_7/32	送り歯 SA 7/32	1
139		400-2577	FEED_DOG_TYPE_SA_1/4	送り歯 SA 1/4	1
140		400-2576	FEED_DOG_TYPE_SA_5/32	送り歯 SA 5/32	1
141		400-2578	FEED_DOG_TYPE_SA_3/16	送り歯 SA 3/16	1
142		400-2576	FEED_DOG_TYPE_SA_7/32	送り歯 SA 7/32	1
143		400-2576	FEED_DOG_TYPE_SA_1/2	送り歯 SA 1/2	1
144		400-2573	FEED_DOG_TYPE_SA_5/8	送り歯 SA 5/8	1
145		400-2574	FEED_DOG_TYPE_SA_3/4	送り歯 SA 3/4	1
146		400-2576	FEED_DOG_TYPE_SA_7/8	送り歯 SA 7/8	1
147		400-2576	FEED_DOG_TYPE_SA_1	送り歯 SA 1	1
148		B115-512-Q0H	FEED_DOG_5/32	送り歯 5/32 (厚物)	1
149		B115-512-Q0H	FEED_DOG_3/16	送り歯 3/16 (厚物)	1
150		B115-512-Q0H	FEED_DOG_7/32	送り歯 7/32 (厚物)	1
151		B115-512-Q0H	FEED_DOG_1/4	送り歯 1/4 (厚物)	1
152		B115-512-Q0H	FEED_DOG_9/32	送り歯 9/32 (厚物)	1
153		B115-512-Q0H	FEED_DOG_5/8	送り歯 5/8 (厚物)	1
154		B115-512-Q0H	FEED_DOG_3/4	送り歯 3/4 (厚物)	1
155		B115-512-Q0H	FEED_DOG_1/2	送り歯 1/2 (厚物)	1
156		B115-512-M0H	FEED_DOG_5/8	送り歯 5/8 (厚物)	1
157		B115-512-N0H	FEED_DOG_3/4	送り歯 3/4 (厚物)	1
158		B115-512-Q0H	FEED_DOG_7/8	送り歯 7/8 (厚物)	1
159		B115-512-Q0H	FEED_DOG_1"	送り歯 1" (厚物)	1
160		400-2581	FEED_DOG_TYPE_G_3/16	送り歯 G 3/16	1
161		400-2582	FEED_DOG_TYPE_G_7/32	送り歯 G 7/32	1
162		400-2583	FEED_DOG_TYPE_G_1/4	送り歯 G 1/4	1
163		400-2584	FEED_DOG_TYPE_G_5/16	送り歯 G 5/16	1
164		400-2585	FEED_DOG_TYPE_G_3/8	送り歯 G 3/8	1
165		400-2586	FEED_DOG_TYPE_G_1/2	送り歯 G 1/2	1
166		400-2588	FEED_DOG_TYPE_G_5/8	送り歯 G 5/8	1
167		400-2589	FEED_DOG_TYPE_G_3/4	送り歯 G 3/4	1
168		400-2581	FEED_DOG_TYPE_G_7/8	送り歯 G 7/8	1
169		400-2582	FEED_DOG_TYPE_G_1	送り歯 G 1	1
170		400-2586	PRESSER_FOOT_ASM_1/8	先駆脚組 (厚) 1/8	1
171		400-2587	PRESSER_FOOT_ASM_5/32	先駆脚組 (厚) 5/32	1
172		228-4025	PRESSER_FOOT_ASM_3/16(4.8MM)	先駆脚組 (厚) 3/16 (4.8MM)	1
173		228-4042	PRESSER_FOOT_ASM_7/32(5.5MM)	先駆脚組 (厚) 7/32 (5.5MM)	1
174		228-4051	PRESSER_FOOT_ASM_1/4(6.4MM)	先駆脚組 (厚) 1/4 (6.4MM)	1
175		228-4052	PRESSER_FOOT_ASM_5/16(7.9MM)	先駆脚組 (厚) 5/16 (7.9MM)	1
176		228-4079	PRESSER_FOOT_ASM_3/8(9.5MM)	先駆脚組 (厚) 3/8 (9.5MM)	1
177		228-4085	PRESSER_FOOT_ASM_1/2(12.7MM)	先駆脚組 (厚) 1/2 (12.7MM)	1
178		228-4097	PRESSER_FOOT_ASM_5/8(15.9MM)	先駆脚組 (厚) 5/8 (15.9MM)	1
179		228-4123	PRESSER_FOOT_ASM_3/4(19.1MM)	先駆脚組 (厚) 3/4 (19.1MM)	1
180		228-4181	PRESSER_FOOT_ASM_7/8(22.9MM)	先駆脚組 (厚) 7/8 (22.9MM)	1
181		228-4120	PRESSER_FOOT_ASM_1(25.4MM)	先駆脚組 (厚) 1" (25.4MM)	1
182		228-4188	PRESSER_FOOT_ASM_105(4MM)	先駆脚組 (厚) 105 (4MM)	1
183		228-4170	PRESSER_FOOT_ASM_105(4MM)	先駆脚組 (厚) 105 (4MM)	1
184		400-7190	PRESSER_FOOT_ASM_G_5/32	先駆脚組 G (厚) 5/32	1
185		228-1895	TIP-DIVIDED_PRESSER_ASM_7/32	先駆脚組 G (厚) 7/32	1
186		228-1896	TIP-DIVIDED_PRESSER_ASM_3/16	先駆脚組 G (厚) 3/16	1
187		228-1875	PRESSER_FOOT_ASM_1/4"	先駆脚組 G (厚) 1/4"	

27. TABLE OF EXCHANGING GAUGE PARTS (FOR LH-3568A-7)

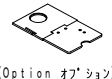
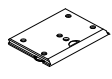
交換ゲージ部品一覧表 (LH-3568A-7 用)



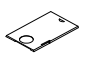

Needle gauge size 針 幅			Feed Dog 送 り 歯								Presser foot asm. 押 さ え (組)				Swivel guide Presser asm. スワイブルガイド 押さえ (組)		Throat plate 針 板	
Code コード*			Option オプション		Option オプション		Option オプション		(Tip-divided) (移動式先割れ)		(Tip-divided) (移動式先割れ)							
			No.	Part No.	No.	Part No.	No.	Part No.	No.	Part No.	No.	Part No.						
B	1/8	3.2	1	400-61270	14	400-35890	—	—	39	400-53705	51	400-35896	—	—	78	400-35881		
C	5/32	4.0	2	400-61271	15	400-25817	27	400-71911	—	—	52	400-35897	64	400-71909	79	400-25485		
D	3/16	4.8	3	400-61272	16	400-25818	28	400-35891	40	400-25831	53	226-40353	65	228-16657	76	400-25490		
E	7/32	5.6	4	400-61273	17	400-25819	29	400-50009	41	400-25832	54	226-40452	66	228-16656	197	402-29461		
F	1/4	6.4	5	400-61274	18	400-26715	30	400-35892	42	400-25833	55	226-40551	67	228-16755	77	400-94776		
G	9/32	7.1	6	400-61275	19	400-25820	31	400-50010	43	400-25834	56	226-40759	68	228-16854	198	402-29459		
H	5/16	7.9	7	400-61276	20	400-25821	32	400-50011	44	400-25835	57	226-40858	69	228-16953	—	—		
K	3/8	9.5	8	400-61277	21	400-25822	33	400-35893	45	400-25836	58	226-40957	70	228-17050	—	—		
L	1/2	12.7	9	400-61278	22	400-25824	34	400-35894	46	400-25838	59	226-41252	71	228-17159	—	—		
M	5/8	15.9	10	400-61279	23	400-25825	35	400-71912	47	400-25839	60	226-41351	72	400-33945	—	—		
N	3/4	19.1	11	400-61280	24	400-25826	36	400-35895	48	400-25840	61	226-41450	73	400-33947	—	—		
P	7/8	22.2	12	400-61281	25	400-25827	37	400-71913	49	400-25841	62	226-41658	74	400-33949	—	—		
Q	1	25.4	13	400-61282	26	400-25828	38	400-71914	50	400-25842	63	226-41757	75	400-33951	—	—		
Stitch spec.	S	G	★	★	★	★	★	★	★	★	★	★	★	★	★	★		

Needle gauge size 針 幅			Needle clamp asm. (for DP5) 針 留 組 (DP5用)								Sliding plate asm. (Left) 滑り板 (左) 組		Sliding plate asm. (Front) 滑り板 (前) 組	
Code コード*			Needle clamp asm. (Left) 針留 (左) 組		Needle clamp asm. (Right) 針留 (右) 組		Needle clamp asm. (Left) 針留 (左) 組		Needle clamp asm. (Right) 針留 (右) 組					
			No.	Part No.	No.	Part No.	No.	Part No.	No.	Part No.				
B	1/8	3.2	93	400-35761	105	400-35771	117	B1402-528-BA0-A	117	B1402-528-BA0-A	141	400-51633	144	400-42880
C	5/32	4.0	94	400-35762	106	400-35772	118	B1402-528-CA0-A	118	B1402-528-CA0-A				
D	3/16	4.8	95	B1402-528-DAL-A	107	B1402-528-DAR-A	119	B1402-528-DAL-A	130	B1402-528-DAR-A				
E	7/32	5.6	96	B1402-528-EAL	108	B1402-528-EAR	120	B1402-528-EAL	131	B1402-528-EAR				
F	1/4	6.4	97	B1402-528-FAL-A	109	B1402-528-FAR-A	121	B1402-528-FAL-A	132	B1402-528-FAR-A				
G	9/32	7.1	98	400-35765	110	400-35775	122	B1402-528-GAL	133	B1402-528-GAR				
H	5/16	7.9	99	400-35766	111	400-35776	123	B1402-528-HAL-A	134	B1402-528-HAR-A				
K	3/8	9.5	—	—	—	—	124	B1402-528-KAL-A	135	B1402-528-KAR-A				
L	1/2	12.7	100	400-35768	112	400-35778	125	B1402-528-LAL	136	B1402-528-LAR				
M	5/8	15.9	101	400-35769	113	400-35779	126	B1402-528-MAL	137	B1402-528-MAR				
N	3/4	19.1	102	400-35770	114	400-35780	127	B1402-528-NAL	138	B1402-528-NAR				
P	7/8	22.2	103	400-71917	115	400-71919	128	B1402-528-PAL	139	B1402-528-PAR				
Q	1	25.4	104	400-71921	116	400-71923	129	B1402-528-QAL	140	B1402-528-QAR				
Stitch spec.	S	G	Spec. common				Spec. common							

Needle gauge size 針 幅			Needle clamp asm. (for DP17) 針 留 組 (DP17用)								Sliding plate asm. (Left) 滑り板 (左) 組		Sliding plate asm. (Right) 滑り板 (右) 組	
Code コード*			Needle clamp asm. (Left) 針留 (左) 組		Needle clamp asm. (Right) 針留 (右) 組		Needle clamp asm. (Left) 針留 (左) 組		Needle clamp asm. (Right) 針留 (右) 組					
			No.	Part No.	No.	Part No.	No.	Part No.	No.	Part No.				
B	1/8	3.2	145	400-35877	157	400-35878	169	B1402-526-BA0-A	169	B1402-526-BA0-A	191	400-25247	194	400-25235
C	5/32	4.0	146	400-26063	158	400-26084	170	B1402-526-CA0-A	170	B1402-526-CA0-A				
D	3/16	4.8	147	400-26065	159	400-26086	171	B1402-526-DAL-A	181	B1402-526-DAR-A				
E	7/32	5.6	148	400-26067	160	400-26088	172	102-28559	182	102-28567				
F	1/4	6.4	149	400-26069	161	400-26090	173	B1402-526-FAL-A	183	B1402-526-FAR-A				
G	9/32	7.1	150	400-26070	162	400-26091	174	B1402-526-GAL-A	184	B1402-526-GAR-A				
H	5/16	7.9	151	400-26072	163	400-26093	175	B1402-526-HAL-A	185	B1402-526-HAR-A				
K	3/8	9.5	152	400-26074	164	400-26095	176	B1402-526-KAL-A	186	B1402-526-KAR-A				
L	1/2	12.7	153	400-26076	165	400-26097	177	B1402-526-LAL-A	187	B1402-526-LAR-A				
M	5/8	15.9	154	400-26078	166	400-26099	178	102-28856	188	102-28864				
N	3/4	19.1	155	400-26080	167	400-26101	179	102-28955	189	102-28963				
P	7/8	22.2	—	—	—	—	—	—	—					
Q	1	25.4	156	400-26082	168	400-26103	180	102-29151	190	102-29169				
Stitch spec.	S	G	Spec. common		Spec. common		Spec. common		Spec. common					

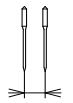
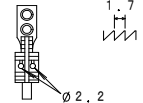
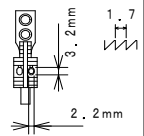
28. TABLE OF EXCHANGING GAUGE PARTS (LH-3578A TYPE G)

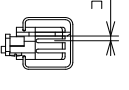
交換ゲージ部品一覧表 (LH-3578A G 仕様)

Needle gauge size 針 幅		Feed Dog 送り歯				Needle clamp asm. 針 留 組		Presser foot asm. 押 さ え (組)		Swivel guide Presser asm. スイフ'ルカ'イト' 押さえ (組)		Throat plate (with Taping) 針 板 (テープ付)		Throat plate 針 板	
Code コード*															
		inch	mm	No.	Part No.	No.	Part No.	No.	Part No.	No.	Part No.	No.	Part No.	No.	Part No.
A	3/32 2.4		—		—	35	101-47551		—		—		—		—
B	1/8 3.2	1	B1613-512-B0H		—	36	101-47650		—		—	73	226-28002		—
C	5/32 4.0	2	B1613-512-C0H		—	37	101-47759	54	400-71909		—	74	226-28101		—
D	3/16 4.8	3	B1613-512-D0H	19	400-25801	38	101-47858	55	228-16557	71	400-95293	75	226-28200	80	400-95288
E	7/32 5.6	4	B1613-512-E0H	20	400-25802	39	101-47957	56	228-16656	97	402-29461		—		—
F	1/4 6.4	5	B1613-512-F0H	21	400-25803	40	101-48054	57	228-16755	72	400-94776	77	226-28408	81	400-94772
G	9/32 7.1	6	B1613-512-G0H	22	400-25804	41	101-48153	58	228-16854	98	402-29459		—		—
H	5/16 7.9	7	B1613-512-H0H	23	400-25805	42	101-48252	59	228-16953		—	78	226-28507		—
K	3/8 9.5	8	B1613-512-K0H	24	400-25806	43	101-48351	60	228-17050		—	79	226-28606		—
W	7/16 11.1	9	400-75311	25	400-25807	44	101-48450	61	400-33941		—		—		—
L	1/2 12.7	10	B1613-512-L0H	26	400-25808	45	101-48559	62	228-17159		—		—		—
M	5/8 15.9	11	B1613-512-M0H	27	400-25809	46	101-48658	63	400-33945		—		—		—
N	3/4 19.1	12	B1613-512-N0H	28	400-25810	47	101-48757	64	400-33947		—		—		—
P	7/8 22.2	13	B1613-512-P0H	29	400-25811	48	101-48856	65	400-33949		—		—		—
Q	1 25.4	14	B1613-512-Q0H	30	400-25812	49	101-48955	66	400-33951		—		—		—
R	1-1/8 28.6	15	B1613-512-R0H	31	400-25813	50	101-49052	67	400-33953		—		—		—
S	1-1/4 31.8	16	B1613-512-S0H	32	400-25814	51	101-49151	68	400-33955		—		—		—
T	1-3/8 34.9	17	B1613-512-T0H	33	400-25815	52	101-49250	69	400-33957		—		—		—
U	1-1/2 38.1	18	B1613-512-U0H	34	400-25816	53	101-49359	70	400-33959		—		—		—

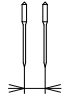
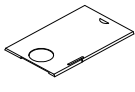
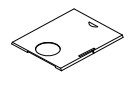
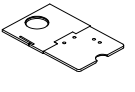
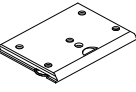
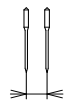
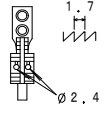
Needle gauge size 針 幅		Sliding plate asm. (Left) 滑り板 (左) 組		Sliding plate asm. (Right) 滑り板 (右) 組		Sliding plate asm. (Left) 滑り板 (左) 組		Sliding plate asm. (Front) 滑り板 (前) 組		Needle gauge size 針 幅		Feed Dog 送り歯			
Code コード*															
		inch	mm	No.	Part No.	No.	Part No.	No.	Part No.	No.	Part No.	inch	mm	No.	Part No.
A	3/32 2.4														
B	1/8 3.2														
C	5/32 4.0														
D	3/16 4.8														
E	7/32 5.6														
F	1/4 6.4														
G	9/32 7.1														
H	5/16 7.9														
K	3/8 9.5														
W	7/16 11.1														
L	1/2 12.7														
M	5/8 15.9														
N	3/4 19.1														
P	7/8 22.2														
Q	1 25.4														
R	1-1/8 28.6														
S	1-1/4 31.8														
T	1-3/8 34.9														
U	1-1/2 38.1														



D	3/16	4.8	95	400-95291
F	1/4	6.4	96	400-94774

REF.NO	NOTE	PART NO	DESCRIPTION	品名	Qty
1		B1613-512-B0H	FEED DOG 1/8"	送り歯 1/8 (厚物)	1
2		B1613-512-C0H	FEED DOG 5/32"	送り歯 5/32 (厚物)	1
3		B1613-512-D0H	FEED DOG 3/16"	送り歯 3/16 (厚物)	1
4		B1613-512-E0H	FEED DOG 7/32"	送り歯 7/32 (厚物)	1
5		B1613-512-F0H	FEED DOG 1/4"	送り歯 1/4 (厚物)	1
6		B1613-512-G0H	FEED DOG 9/32"	送り歯 9/32 (厚物)	1
7		B1613-512-H0H	FEED DOG 5/16"	送り歯 5/16 (厚物)	1
8		B1613-512-K0H	FEED DOG 3/8"	送り歯 3/8 (厚物)	1
9		400-75311	FEED_DOG_TYPE_G_7/16	送り歯G仕様 7/16"	1
10		B1613-512-L0H	FEED DOG 1/2"	送り歯 1/2 (厚物)	1
11		B1613-512-M0H	FEED DOG 5/8"	送り歯 5/8 (厚物)	1
12		B1613-512-N0H	FEED DOG 3/4"	送り歯 3/4 (厚物)	1
13		B1613-512-P0H	FEED DOG 7/8"	送り歯 7/8 (厚物)	1
14		B1613-512-Q0H	FEED DOG 1"	送り歯 1インチ (厚物)	1
15		B1613-512-R0H	FEED DOG 1-1/8"	送り歯 1-1/8 (厚物)	1
16		B1613-512-S0H	FEED DOG 1-1/4"	送り歯 1-1/4 (厚物)	1
17		B1613-512-T0H	FEED DOG 1-3/8"	送り歯 1-3/8 (厚物)	1
18		B1613-512-U0H	FEED DOG 1-1/2"	送り歯 1-1/2 (厚物)	1
19		400-25801	FEED_DOG_TYPE_G_3/16	送り歯G 3/16	1
20		400-25802	FEED_DOG_TYPE_G_7/32	送り歯G 7/32	1
21		400-25803	FEED_DOG_TYPE_G_1/4	送り歯G 1/4	1
22		400-25804	FEED_DOG_TYPE_G_9/32	送り歯G 9/32	1
23		400-25805	FEED_DOG_TYPE_G_5/16	送り歯G 5/16	1
24		400-25806	FEED_DOG_TYPE_G_3/8	送り歯G 3/8	1
25		400-25807	FEED_DOG_TYPE_G_7/16	送り歯G 7/16	1
26		400-25808	FEED_DOG_TYPE_G_1/2	送り歯G 1/2	1
27		400-25809	FEED_DOG_TYPE_G_5/8	送り歯G 5/8	1
28		400-25810	FEED_DOG_TYPE_G_3/4	送り歯G 3/4	1
29		400-25811	FEED_DOG_TYPE_G_7/8	送り歯G 7/8	1
30		400-25812	FEED_DOG_TYPE_G_1	送り歯G 1	1
31		400-25813	FEED_DOG_TYPE_G_1-1/8	送り歯G 1-1/8	1
32		400-25814	FEED_DOG_TYPE_G_1-1/4	送り歯G 1-1/4	1
33		400-25815	FEED_DOG_TYPE_G_1-3/8	送り歯G 1-3/8	1
34		400-25816	FEED_DOG_TYPE_G_1-1/2	送り歯G 1-1/2	1
35		101-47551	NEEDLE CLAMP ASM. 3/32"	針留 3/32組	1
36		101-47650	NEEDLE CLAMP ASM. 1/8"	針留 1/8組	1
37		101-47759	NEEDLE CLAMP ASM. 5/32"	針留 5/32組	1
38		101-47858	NEEDLE CLAMP ASM. 3/16"	針留 3/16組	1
39		101-47957	NEEDLE CLAMP ASM. 7/32"	針留 7/32組	1
40		101-48054	NEEDLE CLAMP ASM. 1/4"	針留 1/4組	1
41		101-48153	NEEDLE CLAMP ASM. 9/32"	針留 9/32組	1
42		101-48252	NEEDLE CLAMP ASM. 5/16"	針留 5/16組	1
43		101-48351	NEEDLE CLAMP ASM. 3/8"	針留 3/8組	1
44		101-48450	NEEDLE CLAMP ASM. 7/16"	針留 7/16組	1
45		101-48559	NEEDLE CLAMP ASM. 1/2"	針留 1/2組	1
46		101-48658	NEEDLE CLAMP ASM. 5/8"	針留 5/8組	1
47		101-48757	NEEDLE CLAMP ASM. 3/4"	針留 3/4組	1
48		101-48856	NEEDLE CLAMP ASM. 7/8"	針留 7/8組	1
49		101-48955	NEEDLE CLAMP ASM. 1"	針留 1"組	1
50		101-49052	NEEDLE CLAMP ASM. 1-1/8"	針留 1-1/8組	1
51		101-49151	NEEDLE CLAMP ASM. 1-1/4"	針留 1-1/4組	1
52		101-49250	NEEDLE CLAMP ASM. 1-3/8"	針留 1-3/8組	1
53		101-49359	NEEDLE CLAMP ASM. 1-1/2"	針留 1-1/2組	1
54		400-71909	PRESSER_FOOT_ASM_G_5/32	先割自由押えG (組) 5/32	1
55		228-16557	TIP-DIVIDED PRESSER ASM. 3/16	先割自由押え 2.4 (組) 3/16"	1
56		228-16656	TIP-DIVIDED PRESSER ASM. 7/32	先割自由押え 2.4 (組) 7/32"	1
57		228-16755	PRESSER FOOT ASM. 1/4"	先割自由押え 2.4 (組) 1/4"	1
58		228-16854	TIP-DIVIDED PRESSER ASM. 9/32	先割自由押え 2.4 (組) 9/32"	1
59		228-16953	TIP-DIVIDED PRESSER ASM. 5/16	先割自由押え 2.4 (組) 5/16"	1
60		228-17050	PRESSER FOOT ASM. D=2.4 (3/8)	先割自由押え 2.4 (組) 3/8"	1
61		400-33941	TIP-DIVIDED_PRESSER_ASM_7/16	先割自由押え (組) 7/16	1
62		228-17159	PRESSER FOOT ASM. D=2.4 (1/2)	先割自由押え 2.4 (組) 1/2"	1
63		400-33945	TIP-DIVIDED_PRESSER_ASM_5/8	先割自由押え (組) 5/8	1
64		400-33947	TIP-DIVIDED_PRESSER_ASM_3/4	先割自由押え (組) 3/4	1
65		400-33949	TIP-DIVIDED_PRESSER_ASM_7/8	先割自由押え (組) 7/8	1
66		400-33951	TIP-DIVIDED_PRESSER_ASM_1	先割自由押え (組) 1	1
67		400-33953	TIP-DIVIDED_PRESSER_ASM_1_1/8	先割自由押え (組) 1_1/8	1
68		400-33955	TIP-DIVIDED_PRESSER_ASM_1_1/4	先割自由押え (組) 1_1/4	1
69		400-33957	TIP-DIVIDED_PRESSER_ASM_1_3/8	先割自由押え (組) 1_3/8	1
70		400-33959	TIP-DIVIDED_PRESSER_ASM_1_1/2	先割自由押え (組) 1_1/2	1
71	#01	400-95293	ASSY_PRESSER_FOOT_G3/16	スィブルガイド押さえ 3/16	1
72	#01	400-94776	ASSY_PRESSER_FOOT_G1/4	スィブルガイド押さえ	1
73		226-28002	THROAT PLATE 1/8"	テーブ付針板 (1/8")	1
74		226-28101	THROAT PLATE 5/32"	テーブ付針板 (5/32")	1
75		226-28200	THROAT PLATE 3/16"	テーブ付針板 (3/16")	1
76		226-28309	THROAT PLATE 7/32"	テーブ付針板 (7/32")	1
77		226-28408	THROAT PLATE 1/4"	テーブ付針板 (1/4")	1
78		226-28507	THROAT PLATE 9/32"	テーブ付針板 (9/32")	1
79		226-28606	TAPING THROT PLATE 5/16	テーブ付針板 (5/16")	1
80		400-95288	THROAT PLATE 3/16(4.8MM)	針板 (糸切り無) 3/16 (4.8MM)	1
81		400-94772	THROAT PLATE 1/4	針板	1
82		226-01058	BED SLIDE LEFT, ASM., A	滑り板 (左) A組	1
83		226-01157	LEFT SLIDER PLATE B ASM.	滑り板 (左) B組	1
84		226-01256	BED SLIDE LEFT, ASM., C	滑り板 (左) C組	1
85		226-01355	BED SLIDE LEFT, ASM., D	滑り板 (左) D組	1
86		226-00555	BED SLIDE RIGHT, ASM., A	滑り板 (右) A組	1
87		226-00654	RIGHT SLIDER PLATE B ASM.	滑り板 (右) B組	1
88		226-00753	BED SLIDE RIGHT, ASM., C	滑り板 (右) C組	1
89		226-00852	BED SLIDE RIGHT, ASM., D	滑り板 (右) D組	1
90		400-51633	ASSY_SLIDE_PLATE_L	はね上げ式滑り板組	1
91		400-45729	ASSY_SIDE_PLATE-L-B	滑り板左組	1
92		400-45730	ASSY_SIDE_PLATE-L-C	滑り板左組	1
93		400-45731	ASSY_SIDE_PLATE-L-D	滑り板左組	1
94		400-42874	ASSY_SLIDE_PLATE_F_STANDARD	滑り板前糸切り無組	1
95		400-95291	FEED_DOG 3/16	送り歯 (糸切り無し) 3/16	1
96		400-94774	FEED_DOG 1/4	送り歯	1
97	#02	402-29461	ASSY_PRESSER_FOOT_G3/16	スィブルガイド押さえ 3/16"	1
98	#02	402-29459	ASSY_PRESSER_FOOT_G_1/4	スィブルガイド押さえG (組) 1/4"	1
		NOTE(注記)	#01...EDGE 3mm #02...EDGE 2mm	コバ 3mm コバ 2mm	

29. TABLE OF EXCHANGING GAUGE PARTS (LH-3588A TYPE G)

交換ゲージ部品一覧表 (LH-3588A G 仕様)

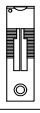
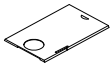
Needle gauge size 針 幅			Needle clamp asm. (for DP17) 針 留 組 (DP17用)				Needle clamp asm. (for DP5) 針 留 組 (DP5用)			
Code コード*			Needle clamp asm. (Left) 針 留 (左) 組		Needle clamp asm. (Right) 針 留 (右) 組		Needle clamp asm. (Left) 針 留 (左) 組		Needle clamp asm. (Right) 針 留 (右) 組	
	inch	mm	No.	Part No.	No.	Part No.	No.	Part No.	No.	Part No.
B	1/8	3.2	1	B1402-526-BA0-A	1	B1402-526-BA0-A	23	B1402-528-BA0-A	23	B1402-528-BA0-A
C	5/32	4.0	2	B1402-526-CA0-A	2	B1402-526-CA0-A	24	B1402-528-CA0-A	24	B1402-528-CA0-A
D	3/16	4.8	3	B1402-526-DAL-A	13	B1402-526-DAR-A	25	B1402-528-DAL-A	36	B1402-528-DAR-A
E	7/32	5.6	4	102-28559	14	102-28567	26	B1402-528-EAL	37	B1402-528-EAR
F	1/4	6.4	5	B1402-526-FAL-A	15	B1402-526-FAR-A	27	B1402-528-FAL-A	38	B1402-528-FAR-A
G	9/32	7.1	6	B1402-526-GAL-A	16	B1402-526-GAR-A	28	B1402-528-GAL	39	B1402-528-GAR
H	5/16	7.9	7	B1402-526-HAL-A	17	B1402-526-HAR-A	29	B1402-528-HAL-A	40	B1402-528-HAR-A
K	3/8	9.5	8	B1402-526-KAL-A	18	B1402-526-KAR-A	30	B1402-528-KAL-A	41	B1402-528-KAR-A
L	1/2	12.7	9	B1402-526-LAL-A	19	B1402-526-LAR-A	31	B1402-528-LAL	42	B1402-528-LAR
M	5/8	15.9	10	102-28856	20	102-28864	32	B1402-528-MAL	43	B1402-528-MAR
N	3/4	19.1	11	102-28955	21	102-28963	33	B1402-528-NAL	44	B1402-528-NAR
P	7/8	22.2		—		—	34	B1402-528-PAL	45	B1402-528-PAR
Q	1	25.4	12	102-29151	22	102-29169	35	B1402-528-QAL	46	B1402-528-QAR

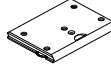
Needle gauge size 針 幅			Throat plate 針 板		Sliding plate asm. (Left) 滑り板 (左) 組		Sliding plate asm. (Right) 滑り板 (右) 組		Sliding plate asm. (Left) 滑り板 (左) 組		Sliding plate asm. (Front) 滑り板 (前) 組	
Code コード*												
	inch	mm	No.	Part No.	No.	Part No.	No.	Part No.	No.	Part No.	No.	Part No.
B	1/8	3.2		—		—		—		—		—
C	5/32	4.0		—		—		—		—		—
D	3/16	4.8	47	400-95288		—		—		—		—
E	7/32	5.6		—		—		—		—		—
F	1/4	6.4	48	400-94772	49	226-01058	52	226-00555	55	400-51633		—
G	9/32	7.1		—		—		—		—		—
H	5/16	7.9		—		—		—		—		—
K	3/8	9.5		—		—		—		—		—
L	1/2	12.7		—		—		—		—		—
M	5/8	15.9		—	50	226-01157	53	226-00654	56	400-45729		—
N	3/4	19.1		—		—		—		—		—
P	7/8	22.2		—		—		—		—		—
Q	1	25.4		—	51	226-01256	54	226-00753	57	400-45730		—

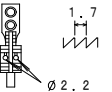
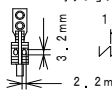
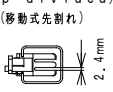
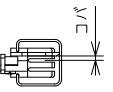
Needle gauge size 針 幅			Feed Dog 送り 歯				Presser foot asm. 押 さ え (組)		Swivel guide Presser asm. スイフ ルカ イト 押 さ え (組)			
Code コード*					Option オプション 							
	inch	mm	No.	Part No.	No.	Part No.	No.	Part No.	No.	Part No.		
B	1/8	3.2		—		—		—		—		
C	5/32	4.0	59	B1613-512-C0H		—		82	400-71909		—	
D	3/16	4.8	60	B1613-512-D0H	71	400-25801	96	400-95291	83	228-16557	94	400-95293
E	7/32	5.6	61	B1613-512-E0H	72	400-25802		—	84	228-16656	98	402-29461
F	1/4	6.4	62	B1613-512-F0H	73	400-25803	97	400-94774	85	228-16755	95	400-94776
G	9/32	7.1	63	B1613-512-G0H	74	400-25804		—	86	228-16854	99	402-29459
H	5/16	7.9	64	B1613-512-H0H	75	400-25805		—	87	228-16953		—
K	3/8	9.5	65	B1613-512-K0H	76	400-25806		—	88	228-17050		—
L	1/2	12.7	66	B1613-512-L0H	77	400-25808		—	89	228-17159		—
M	5/8	15.9	67	B1613-512-M0H	78	400-25809		—	90	400-33945		—
N	3/4	19.1	68	B1613-512-N0H	79	400-25810		—	91	400-33947		—
P	7/8	22.2	69	B1613-512-P0H	80	400-25811		—	92	400-33949		—
Q	1	25.4	70	B1613-512-Q0H	81	400-25812		—	93	400-33951		—

REF.NO	NOTE	PART NO	DESCRIPTION	品名	Qty
1		B1402-526-BA0-A	NEEDLE CLAMP ASM. 1/8"	針留 1/8組	1
2		B1402-526-CA0-A	NEEDLE CLAMP ASM. 5/32"	針留 5/32組	1
3		B1402-526-DAL-A	NEEDLE CLAMP LEFT ASM. 3/16"	針留左 3/16組	1
4		102-28559	NEEDLE CLAMP ASM. LEFT 7/32	針留左組 7/32	1
5		B1402-526-FAL-A	NEEDLE CLAMP LEFT ASM. 1/4	針留左 1/4組	1
6		B1402-526-GAL-A	NEEDLE CLAMP LEFT ASM. 9/32"	針留左 9/32組	1
7		B1402-526-HAL-A	NEEDLE CLAMP LEFT ASM. 5/16"	針留左 5/16組	1
8		B1402-526-KAL-A	NEEDLE CLAMP LEFT ASM. 3/8"	針留左 3/8組	1
9		B1402-526-LAL-A	NEEDLE CLAMP LEFT ASM.	針留左 1/2組	1
10		102-28856	NEEDLE CLAMP ASM. LEFT 5/8	針留左組 5/8	1
11		102-28955	NEEDLE CLAMP ASM. LEFT 3/4	針留左組 3/4	1
12		102-29151	NEEDLE CLAMP ASM. LEFT 1"	針留左組 1	1
13		B1402-526-DAR-A	NEEDLE CLAMP RIGHT ASM. 3/16"	針留右 3/16組	1
14		102-28567	NEEDLE CLAMP ASM. RIGHT 7/32	針留右組 7/32	1
15		B1402-526-FAR-A	NEEDLE CLAMP RIGHT ASM. 1/4	針留右 1/4組	1
16		B1402-526-GAR-A	NEEDLE CLAMP RIGHT ASM. 9/32"	針留右 9/32組	1
17		B1402-526-HAR-A	NEEDLE CLAMP RIGHT ASM. 5/16"	針留右 5/16組	1
18		B1402-526-KAR-A	NEEDLE CLAMP RIGHT ASM. 3/8"	針留右 3/8組	1
19		B1402-526-LAR-A	NEEDLE CLAMP RIGHT ASM.	針留右 1/2組	1
20		102-28864	NEEDLE CLAMP ASM. RIGHT 5/8	針留右組 5/8	1
21		102-28963	NEEDLE CLAMP ASM. RIGHT 3/4	針留右組 3/4	1
22		102-29169	NEEDLE CLAMP ASM. RIGHT 1"	針留右組 1	1
23		B1402-528-BA0-A	NEEDLE CLAMP ASM. 1/8	針留 1/8組	1
24		B1402-528-CA0-A	NEEDLE CLAMP ASM. 5/32	針留 5/32組	1
25		B1402-528-DAL-A	NEEDLE CLAMP ASM. LEFT	針留左 3/16組	1
26		B1402-528-EAL	NEEDLE CLAMP ASM. 7/32	針留左 7/32組	1
27		B1402-528-FAL-A	NEEDLE CLAMP ASM. 1/4	針留左 1/4組	1
28		B1402-528-GAL	NEEDLE CLAMP ASM., LEFT	針留左組	1
29		B1402-528-HAL-A	NEEDLE CLAMP ASM. 5/16	針留左 5/16組	1
30		B1402-528-KAL-A	NEEDLE CLAMP ASM. 3/8	針留左 3/8組	1
31		B1402-528-LAL	NEEDLE CLAMP ASM., LEFT 1/2"	針留左 1/2組	1
32		B1402-528-MAL	NEEDLE CLAMP ASM., LEFT 5/8"	針留左 5/8組	1
33		B1402-528-NAL	NEEDLE CLAMP ASM., LEFT 3/4"	針留左 3/4組	1
34		B1402-528-PAL	NEEDLE CLAMP ASM. LEFT 7/8"	針留(左)組 7/8	1
35		B1402-528-QAL	NEEDLE CLAMP ASM., LEFT 1"	針留左 1組	1
36		B1402-528-DAR-A	NEEDLE CLAMP ASM. RIGHT	針留右 3/16組	1
37		B1402-528-EAR	NEEDLE CLAMP ASM. 7/32	針留右 7/32組	1
38		B1402-528-FAR-A	NEEDLE CLAMP ASM. 1/4	針留右 1/4組	1
39		B1402-528-GAR	NEEDLE CLAMP ASM., RIGHT	針留右組	1
40		B1402-528-HAR-A	NEEDLE CLAMP ASM. 5/16	針留右 5/16組	1
41		B1402-528-KAR-A	NEEDLE CLAMP ASM. 3/8	針留右 3/8組	1
42		B1402-528-LAR	NEEDLE CLAMP ASM., RIGHT 1/2"	針留右 1/2組	1
43		B1402-528-MAR	NEEDLE CLAMP ASM., RIGHT 5/8"	針留右 5/8組	1
44		B1402-528-NAR	NEEDLE CLAMP ASM., RIGHT 3/4"	針留右 3/4組	1
45		B1402-528-PAR	NEEDLE CLAMP ASM. RIGHT 7/8"	針留(右)組 7/8	1
46		B1402-528-QAR	NEEDLE CLAMP ASM. RIGHT 1"	針留右 1組	1
47		400-95288	THROAT PLATE 3/16(4.8MM)	針板(糸切り無) 3/16 (4.8MM)	1
48		400-94772	THROAT_PLATE 1/4	針板	1
49		226-01058	BED SLIDE LEFT, ASM., A	滑り板(左) A組	1
50		226-01157	LEFT SLIDER PLATE B ASM.	滑り板(左) B組	1
51		226-01256	BED SLIDE LEFT, ASM., C	滑り板(左) C組	1
52		226-00555	BED SLIDE RIGHT, ASM., A	滑り板(右) A組	1
53		226-00654	RIGHT SLIDER PLATE B ASM.	滑り板(右) B組	1
54		226-00753	BED SLIDE RIGHT, ASM., C	滑り板(右) C組	1
55		400-51633	ASSY_SLIDE_PLATE_L	はね上げ式滑り板組	1
56		400-45729	ASSY_SLIDE_PLATE-L-B	滑り板左組	1
57		400-45730	ASSY_SLIDE_PLATE-L-C	滑り板左組	1
58		400-42874	ASSY_SLIDE_PLATE_F_STANDARD	滑り板前糸切り無組	1
59		B1613-512-C0H	FEED DOG 5/32"	送り歯 5/32 (厚物)	1
60		B1613-512-D0H	FEED DOG 3/16"	送り歯 3/16 (厚物)	1
61		B1613-512-E0H	FEED DOG 7/32"	送り歯 7/32 (厚物)	1
62		B1613-512-F0H	FEED DOG 1/4"	送り歯 1/4 (厚物)	1
63		B1613-512-G0H	FEED DOG 9/32"	送り歯 9/32 (厚物)	1
64		B1613-512-H0H	FEED DOG 5/16"	送り歯 5/16 (厚物)	1
65		B1613-512-K0H	FEED DOG 3/8"	送り歯 3/8 (厚物)	1
66		B1613-512-L0H	FEED DOG 1/2"	送り歯 1/2 (厚物)	1
67		B1613-512-M0H	FEED DOG 5/8"	送り歯 5/8 (厚物)	1
68		B1613-512-N0H	FEED DOG 3/4"	送り歯 3/4 (厚物)	1
69		B1613-512-P0H	FEED DOG 7/8"	送り歯 7/8 (厚物)	1
70		B1613-512-Q0H	FEED DOG 1"	送り歯 1インチ (厚物)	1
71		400-25801	FEED_DOG_TYPE_G_3/16	送り歯G 3/16	1
72		400-25802	FEED_DOG_TYPE_G_7/32	送り歯G 7/32	1
73		400-25803	FEED_DOG_TYPE_G_1/4	送り歯G 1/4	1
74		400-25804	FEED_DOG_TYPE_G_9/32	送り歯G 9/32	1
75		400-25805	FEED_DOG_TYPE_G_5/16	送り歯G 5/16	1
76		400-25806	FEED_DOG_TYPE_G_3/8	送り歯G 3/8	1
77		400-25808	FEED_DOG_TYPE_G_1/2	送り歯G 1/2	1
78		400-25809	FEED_DOG_TYPE_G_5/8	送り歯G 5/8	1
79		400-25810	FEED_DOG_TYPE_G_3/4	送り歯G 3/4	1
80		400-25811	FEED_DOG_TYPE_G_7/8	送り歯G 7/8	1
81		400-25812	FEED_DOG_TYPE_G_1	送り歯G 1	1
82		400-71909	PRESSER_FOOT_ASM_G_5/32	先割自由押えG(組) 5/32	1
83		228-16557	TIP-DIVIDED PRESSER ASM. 3/16	先割自由押え 2.4(組) 3/16"	1
84		228-16656	TIP-DIVIDED PRESSER ASM. 7/32	先割自由押え 2.4(組) 7/32"	1
85		228-16755	PRESSER FOOT ASM. 1/4"	先割自由押え 2.4(組) 1/4"	1
86		228-16854	TIP-DIVIDED PRESSER ASM. 9/32	先割自由押え 2.4(組) 9/32"	1
87		228-16953	TIP-DIVIDED PRESSER ASM. 5/16	先割自由押え 2.4(組) 5/16"	1
88		228-17050	PRESSER FOOT ASM. D=2.4 (3/8)	先割自由押え 2.4(組) 3/8"	1
89		228-17159	PRESSER FOOT ASM. D=2.4 (1/2)	先割自由押え 2.4(組) 1/2"	1
90		400-33945	TIP-DIVIDED_PRESSER_ASM_5/8	先割自由押え(組) 5/8	1
91		400-33947	TIP-DIVIDED_PRESSER_ASM_3/4	先割自由押え(組) 3/4	1
92		400-33949	TIP-DIVIDED_PRESSER_ASM_7/8	先割自由押え(組) 7/8	1
93		400-33951	TIP-DIVIDED_PRESSER_ASM_1	先割自由押え(組) 1	1
94	#01	400-95293	ASSY_PRESSER_FOOT_G3/16	スィブルガイド押さえ 3/16	1
95	#01	400-94776	ASSY_PRESSER_FOOT_G1/4	スィブルガイド押さえ	1
96		400-95291	FEED_DOG_3/16	送り歯(糸切り無) 3/16	1
97		400-94774	FEED_DOG_1/4	送り歯	1
98	#02	402-29461	ASSY_PRESSER_FOOT_G3/16	スィブルガイド押さえ 3/16"	1
99	#02	402-29459	ASSY_PRESSER_FOOT_G_1/4	スィブルガイド押さえG(組) 1/4"	1
		NOTE(注記)	#01...EDGE 3mm #02...EDGE 2mm	コバ 3mm コバ 2mm	

30. TABLE OF EXCHANGING GAUGE PARTS (LH-3578A-7 TYPE G)

交換ゲージ部品一覧表 (LH-3578A-7 G 仕様)

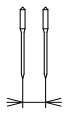
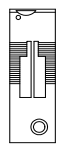
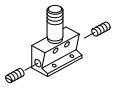
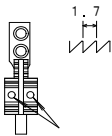
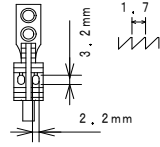

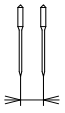
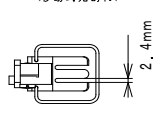
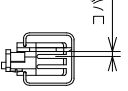
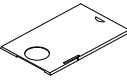
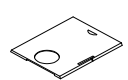
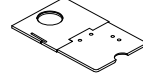
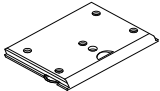
Needle gauge size 針 幅			Throat plate 針 板		Needle clamp asm. 針 留 組		Feed dog 送 り 歯			
Code コード					 Hole Type 穴タイプ		 Ø2.4		 Option オプション	
	inch	mm	No.	Part No.	No.	Part No.	No.	Part No.	No.	Part No.
A	3/32	2.4	—	—	17	101-47551	—	—	—	—
B	1/8	3.2	1	400-35881	18	101-47650	—	—	50	400-53705
C	5/32	4.0	2	400-25485	19	101-47759	36	400-71911	—	—
D	3/16	4.8	3	400-95289	20	101-47858	37	400-35891	51	400-25831
E	7/32	5.6	4	400-25491	21	101-47957	38	400-50009	52	400-25832
F	1/4	6.4	5	400-94773	22	101-48054	39	400-35892	53	400-25833
G	9/32	7.1	6	400-25493	23	101-48153	40	400-50010	54	400-25834
H	5/16	7.9	7	400-25494	24	101-48252	41	400-50011	55	400-25835
K	3/8	9.5	8	400-25495	25	101-48351	42	400-35893	56	400-25836
W	7/16	11.1	9	400-25496	26	101-48450	—	—	57	400-25837
L	1/2	12.7	10	400-25498	27	101-48559	43	400-35894	58	400-25838
M	5/8	15.9	11	400-25499	28	101-48658	44	400-71912	59	400-25839
N	3/4	19.1	12	400-25500	29	101-48757	45	400-35895	60	400-25840
P	7/8	22.2	13	400-25502	30	101-48856	46	400-71913	61	400-25841
Q	1	25.4	14	400-25503	31	101-48955	47	400-71914	62	400-25842
R	1-1/8	28.6	15	400-25504	32	101-49052	48	400-71915	63	400-25843
S	1-1/4	31.8	16	400-25505	33	101-49151	49	400-71916	64	400-25844
T	1-3/8	34.9	—	—	34	101-49250	—	—	—	—
U	1-1/2	38.1	—	—	35	101-49359	—	—	—	—





Needle gauge size 針 幅			Presser foot asm. 押 さ え (組)		Swivel guide Presser asm. スイフ ルカ イト 押 さ え (組)		Sliding plate asm. (Left) 滑 り 板 (左) 組		Sliding plate asm. (Right) 滑 り 板 (右) 組		Sliding plate asm. (Left) 滑 り 板 (左) 組		Sliding plate asm. (Front) 滑 り 板 (前) 組	
Code コード			 (Tip-divided) (移動式先割れ) 2.4mm		 コバ						 Option オプション			
	inch	mm	No.	Part No.	No.	Part No.	No.	Part No.	No.	Part No.	No.	Part No.	No.	Part No.
B	1/8	3.2	—	—	—	—	—	—	—	—	—	—	—	—
C	5/32	4.0	65	400-71909	80	400-95293	—	—	—	—	—	—	—	—
D	3/16	4.8	66	228-16557	95	402-29461	—	—	—	—	—	—	—	—
E	7/32	5.6	67	228-16656	—	—	—	—	—	—	—	—	—	—
F	1/4	6.4	68	228-16755	81	400-94776	82	400-25247	86	400-25235	90	400-51633	—	—
G	9/32	7.1	69	228-16854	96	402-29459	—	—	—	—	—	—	—	—
H	5/16	7.9	70	228-16953	—	—	—	—	—	—	—	—	—	—
K	3/8	9.5	71	228-17050	—	—	—	—	—	—	—	—	—	—
W	7/16	11.1	72	400-33941	—	—	—	—	—	—	—	—	94	400-42880
L	1/2	12.7	73	228-17159	—	—	—	—	—	—	—	—	—	—
M	5/8	15.9	74	400-33945	—	—	83	400-25248	87	400-25236	91	400-45729	—	—
N	3/4	19.1	75	400-33947	—	—	—	—	—	—	—	—	—	—
P	7/8	22.2	76	400-33949	—	—	—	—	—	—	—	—	—	—
Q	1	25.4	77	400-33951	—	—	84	400-25249	88	400-25239	92	400-45730	—	—
R	1-1/8	28.6	78	400-33953	—	—	—	—	—	—	—	—	—	—
S	1-1/4	31.8	79	400-33955	—	—	85	400-25250	89	400-25240	93	400-45731	—	—

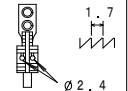
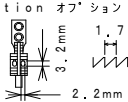

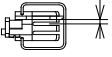

REF.NO	NOTE	PART NO	DESCRIPTION	品名	Qty
1		400-35881	THROAT_PLATE_TRIM_1/8	糸切り針板 1/8	1
2		400-25485	THROAT_PLATE_TRIM_5/32	糸切り針板 5/32	1
3		400-95289	THROAT_PLATE_TRIM_3/16	針板(糸切り) 3/16	1
4		400-25491	THROAT_PLATE_TRIM-7/32	糸切り針板-7/32	1
5		400-94773	THROAT_PLATE_TRIM_1/4	針板糸切り	1
6		400-25493	THROAT_PLATE_TRIM-9/32	糸切り針板-9/32	1
7		400-25494	THROAT_PLATE_TRIM-5/16	糸切り針板-5/16	1
8		400-25495	THROAT_PLATE_TRIM-3/8	糸切り針板-3/8	1
9		400-25496	THROAT_PLATE_TRIM-7/16	糸切り針板-7/16	1
10		400-25498	THROAT_PLATE_TRIM-1/2	糸切り針板-1/2	1
11		400-25499	THROAT_PLATE_TRIM-5/8	糸切り針板-5/8	1
12		400-25500	THROAT_PLATE_TRIM-3/4	糸切り針板-3/4	1
13		400-25502	THROAT_PLATE_TRIM-7/8	糸切り針板-7/8	1
14		400-25503	THROAT_PLATE_TRIM-1	糸切り針板-1	1
15		400-25504	THROAT_PLATE_TRIM-1-1/8	糸切り針板-1-1/8	1
16		400-25505	THROAT_PLATE_TRIM-1-1/4	糸切り針板-1-1/4	1
17		101-47551	NEEDLE CLAMP ASM. 3/32"	針留 3/32組	1
18		101-47650	NEEDLE CLAMP ASM. 1/8"	針留 1/8組	1
19		101-47759	NEEDLE CLAMP ASM. 5/32"	針留 5/32組	1
20		101-47858	NEEDLE CLAMP ASM. 3/16"	針留 3/16組	1
21		101-47957	NEEDLE CLAMP ASM. 7/32"	針留 7/32組	1
22		101-48054	NEEDLE CLAMP ASM. 1/4"	針留 1/4組	1
23		101-48153	NEEDLE CLAMP ASM. 9/32"	針留 9/32組	1
24		101-48252	NEEDLE CLAMP ASM. 5/16"	針留 5/16組	1
25		101-48351	NEEDLE CLAMP ASM. 3/8"	針留 3/8組	1
26		101-48450	NEEDLE CLAMP ASM. 7/16"	針留 7/16組	1
27		101-48559	NEEDLE CLAMP ASM. 1/2"	針留 1/2組	1
28		101-48658	NEEDLE CLAMP ASM. 5/8"	針留 5/8組	1
29		101-48757	NEEDLE CLAMP ASM. 3/4"	針留 3/4組	1
30		101-48856	NEEDLE CLAMP ASM. 7/8"	針留 7/8組	1
31		101-48955	NEEDLE CLAMP ASM. 1"	針留 1"組	1
32		101-49052	NEEDLE CLAMP ASM. 1-1/8"	針留 1-1/8組	1
33		101-49151	NEEDLE CLAMP ASM. 1-1/4"	針留 1-1/4組	1
34		101-49250	NEEDLE CLAMP ASM. 1-3/8"	針留 1-3/8組	1
35		101-49359	NEEDLE CLAMP ASM. 1-1/2"	針留 1-1/2組	1
36		400-71911	FEED_DOG_7G_5/32	糸切り送り歯G_5/32	1
37		400-35891	FEED_DOG_TYPE_7G_3/16	送り歯糸切りG 3/16	1
38		400-50009	FEED_DOG_TYPE_7G_7/32	送り歯糸切りG 7/32	1
39		400-35892	FEED_DOG_TYPE_7G_1/4	送り歯糸切りG 1/4	1
40		400-50010	FEED_DOG_TYPE_7G_9/32	送り歯糸切りG 9/32	1
41		400-50011	FEED_DOG_TYPE_7G_5/16	送り歯糸切りG 5/16	1
42		400-35893	FEED_DOG_TYPE_7G_3/8	送り歯糸切りG 3/8	1
43		400-35894	FEED_DOG_TYPE_7G_1/2	送り歯糸切りG 1/2	1
44		400-71912	FEED_DOG_7G_5/8	糸切り送り歯G_5/8	1
45		400-35895	FEED_DOG_TYPE_7G_3/4	送り歯糸切りG 3/4	1
46		400-71913	FEED_DOG_7G_7/8	糸切り送り歯G_7/8	1
47		400-71914	FEED_DOG_7G_1	糸切り送り歯G_1	1
48		400-71915	FEED_DOG_7G_1-1/8	糸切り送り歯G_1-1/8	1
49		400-71916	FEED_DOG_7G_1-1/4	糸切り送り歯G_1-1/4	1
50		400-53705	FEED_DOG_TYPE_7G_1/8	送り歯糸切りG 1/8	1
51		400-25831	FEED_DOG_TYPE_7G_3/16	送り歯糸切りG 3/16	1
52		400-25832	FEED_DOG_TYPE_7G_7/32	送り歯糸切りG 7/32	1
53		400-25833	FEED_DOG_TYPE_7G_1/4	送り歯糸切りG 1/4	1
54		400-25834	FEED_DOG_TYPE_7G_9/32	送り歯糸切りG 9/32	1
55		400-25835	FEED_DOG_TYPE_7G_5/16	送り歯糸切りG 5/16	1
56		400-25836	FEED_DOG_TYPE_7G_3/8	送り歯糸切りG 3/8	1
57		400-25837	FEED_DOG_TYPE_7G_7/16	送り歯糸切りG 7/16	1
58		400-25838	FEED_DOG_TYPE_7G_1/2	送り歯糸切りG 1/2	1
59		400-25839	FEED_DOG_TYPE_7G_5/8	送り歯糸切りG 5/8	1
60		400-25840	FEED_DOG_TYPE_7G_3/4	送り歯糸切りG 3/4	1
61		400-25841	FEED_DOG_TYPE_7G_7/8	送り歯糸切りG 7/8	1
62		400-25842	FEED_DOG_TYPE_7G_1	送り歯糸切りG 1	1
63		400-25843	FEED_DOG_TYPE_7G_1-1/8	送り歯糸切りG 1-1/8	1
64		400-25844	FEED_DOG_TYPE_7G_1-1/4	送り歯糸切りG 1-1/4	1
65		400-71909	PRESSER_FOOT_ASM_G_5/32	先割自由押えG(組) 5/32	1
66		228-16557	TIP-DIVIDED PRESSER ASM. 3/16	先割自由押え2.4(組) 3/16	1
67		228-16656	TIP-DIVIDED PRESSER ASM. 7/32	先割自由押え2.4(組) 7/32	1
68		228-16755	PRESSER FOOT ASM. 1/4"	先割自由押え2.4(組) 1/4"	1
69		228-16854	TIP-DIVIDED PRESSER ASM. 9/32	先割自由押え2.4(組) 9/32	1
70		228-16953	TIP-DIVIDED PRESSER ASM. 5/16	先割自由押え2.4(組) 5/16	1
71		228-17050	PRESSER FOOT ASM. D=2.4(3/8)	先割自由押え2.4(組) 3/8	1
72		400-33941	TIP-DIVIDED PRESSER_ASM_7/16	先割自由押え(組) 7/16	1
73		228-17159	PRESSER FOOT ASM. D=2.4(1/2)	先割自由押え2.4(組) 1/2	1
74		400-33945	TIP-DIVIDED PRESSER_ASM_5/8	先割自由押え(組) 5/8	1
75		400-33947	TIP-DIVIDED PRESSER_ASM_3/4	先割自由押え(組) 3/4	1
76		400-33949	TIP-DIVIDED PRESSER_ASM_7/8	先割自由押え(組) 7/8	1
77		400-33951	TIP-DIVIDED PRESSER_ASM_1	先割自由押え(組) 1	1
78		400-33953	TIP-DIVIDED PRESSER_ASM_1_1/8	先割自由押え(組) 1_1/8	1
79		400-33955	TIP-DIVIDED PRESSER_ASM_1_1/4	先割自由押え(組) 1_1/4	1
80	#01	400-95293	ASSY_PRESSER_FOOT_G3/16	スィブルガイド押さえ 3/16	1
81	#01	400-94776	ASSY_PRESSER_FOOT_G1/4	スィブルガイド押さえ	1
82		400-25247	ASSY_SLIDE_PLATE-L-A	糸切り滑り板-左-A-組	1
83		400-25248	ASSY_SLIDE_PLATE-L-B	糸切り滑り板-左-B-組	1
84		400-25249	ASSY_SLIDE_PLATE-L-C	糸切り滑り板-左-C-組	1
85		400-25250	ASSY_SLIDE_PLATE-L-D	糸切り滑り板-左-D-組	1
86		400-25235	ASSY_SLIDE_PLATE-R-A	糸切り滑り板-右-A-組	1
87		400-25236	ASSY_SLIDE_PLATE-R-B	糸切り滑り板-右-B-組	1
88		400-25239	ASSY_SLIDE_PLATE-R-C	糸切り滑り板-右-C-組	1
89		400-25240	ASSY_SLIDE_PLATE-R-D	糸切り滑り板-右-D-組	1
90		400-51633	ASSY_SLIDE_PLATE_L	はね上げ式滑り板組	1
91		400-45729	ASSY_SIDE_PLATE-L-B	滑り板左組	1
92		400-45730	ASSY_SIDE_PLATE-L-C	滑り板左組	1
93		400-45731	ASSY_SIDE_PLATE-L-D	滑り板左組	1
94		400-42880	ASSY_SLIDE_PLATE_F	滑り板前糸切り付き組	1
95	#02	402-29461	ASSY_PRESSER_FOOT_G3/16	スィブルガイド押さえ 3/16	1
96	#02	402-29459	ASSY_PRESSER_FOOT_G_1/4	スィブルガイド押さえG(組) 1/4	1
		NOTE(注記)	#01...EDGE 3mm #02...EDGE 2mm	コバ 3mm コバ 2mm	

31. TABLE OF EXCHANGING GAUGE PARTS (LH-3588A-7 TYPE G)

交換ゲージ部品一覧表 (LH-3588A-7 G 仕様)

Needle gauge size 針 幅			Feed Dog 送り歯				Throat plate 針 板		Presser foot asm. 押 さ え (組)		Swivel guide Presser asm. スィフ'ルカ'イト' 押 さ え (組)	
Code コード												
	inch	mm	No.	Part No.	No.	Part No.	No.	Part No.	No.	Part No.	No.	Part No.
B	1/8	3.2	—		13	400-53705	25	400-35881	38	400-35896	—	
C	5/32	4.0	1	400-71911	—		26	400-25485	39	400-71909	—	
D	3/16	4.8	2	400-35891	14	400-25831	27	400-95289	40	228-16557	51	400-95293
E	7/32	5.6	3	400-50009	15	400-25832	28	400-25491	41	228-16656	109	402-29461
F	1/4	6.4	4	400-35892	16	400-25833	29	400-94773	42	228-16755	52	400-94776
G	9/32	7.1	5	400-50010	17	400-25834	30	400-25493	43	228-16854	110	402-29459
H	5/16	7.9	6	400-50011	18	400-25835	31	400-25494	44	228-16953	—	
K	3/8	9.5	7	400-35893	19	400-25836	32	400-25495	45	228-17050	—	
L	1/2	12.7	8	400-35894	20	400-25838	33	400-25498	46	228-17159	—	
M	5/8	15.9	9	400-71912	21	400-25839	34	400-25499	47	400-33945	—	
N	3/4	19.1	10	400-35895	22	400-25840	35	400-25500	48	400-33947	—	
P	7/8	22.2	11	400-71913	23	400-25841	36	400-25502	49	400-33949	—	
Q	1	25.4	12	400-71914	24	400-25842	37	400-25503	50	400-33951	—	

Needle gauge size 針 幅			Needle clamp asm. (for DP5) 針 留 組 (DP5用)				Needle clamp asm. (for DP17) 針 留 組 (DP17用)			
Code コード										
	inch	mm	No.	Part No.	No.	Part No.	No.	Part No.	No.	Part No.
B	1/8	3.2	53	B1402-528-BA0-A	53	B1402-528-BA0-A	77	B1402-526-BA0-A	77	B1402-526-BA0-A
C	5/32	4.0	54	B1402-528-CA0-A	54	B1402-528-CA0-A	78	B1402-526-CA0-A	78	B1402-526-CA0-A
D	3/16	4.8	55	B1402-528-DAL-A	66	B1402-528-DAR-A	79	B1402-526-DAL-A	89	B1402-526-DAR-A
E	7/32	5.6	56	B1402-528-EAL	67	B1402-528-EAR	80	102-28559	90	102-28567
F	1/4	6.4	57	B1402-528-FAL-A	68	B1402-528-FAR-A	81	B1402-526-FAL-A	91	B1402-526-FAR-A
G	9/32	7.1	58	B1402-528-GAL	69	B1402-528-GAR	82	B1402-526-GAL-A	92	B1402-526-GAR-A
H	5/16	7.9	59	B1402-528-HAL-A	70	B1402-528-HAR-A	83	B1402-526-HAL-A	93	B1402-526-HAR-A
K	3/8	9.5	60	B1402-528-KAL-A	71	B1402-528-KAR-A	84	B1402-526-KAL-A	94	B1402-526-KAR-A
L	1/2	12.7	61	B1402-528-LAL	72	B1402-528-LAR	85	B1402-526-LAL-A	95	B1402-526-LAR-A
M	5/8	15.9	62	B1402-528-MAL	73	B1402-528-MAR	86	102-28856	96	102-28864
N	3/4	19.1	63	B1402-528-NAL	74	B1402-528-NAR	87	102-28955	97	102-28963
P	7/8	22.2	64	B1402-528-PAL	75	B1402-528-PAR	—		—	
Q	1	25.4	65	B1402-528-QAL	76	B1402-528-QAR	88	102-29151	98	102-29169

Needle gauge size 針 幅			Sliding plate asm. (Left) 滑り板 (左) 組		Sliding plate asm. (Right) 滑り板 (右) 組		Sliding plate asm. (Left) 滑り板 (左) 組		Sliding plate asm. (Front) 滑り板 (前) 組	
Code コード										
	inch	mm	No.	Part No.	No.	Part No.	No.	Part No.	No.	Part No.
B	1/8	3.2	99		102		105		108	
C	5/32	4.0								
D	3/16	4.8								
E	7/32	5.6								
F	1/4	6.4								
G	9/32	7.1								
H	5/16	7.9								
K	3/8	9.5	100		103		106		108	
L	1/2	12.7								
M	5/8	15.9								
N	3/4	19.1								
P	7/8	22.2								
Q	1	25.4								
Q	1	25.4								
P	7/8	22.2								
Q	1	25.4	101		104		107		108	

REF.NO	NOTE	PART NO	DESCRIPTION	品名	Qty
1		400-71911	FEED_DOG_7G_5/32	糸切り送り歯G_5/32	1
2		400-35891	FEED_DOG_TYPE_7G_3/16	送り歯糸切りG 3/16	1
3		400-50009	FEED_DOG_TYPE_7G_7/32	送り歯糸切りG 7/32	1
4		400-35892	FEED_DOG_TYPE_7G_1/4	送り歯糸切りG 1/4	1
5		400-50010	FEED_DOG_TYPE_7G_9/32	送り歯糸切りG 9/32	1
6		400-50011	FEED_DOG_TYPE_7G_5/16	送り歯糸切りG 5/16	1
7		400-35893	FEED_DOG_TYPE_7G_3/8	送り歯糸切りG 3/8	1
8		400-35894	FEED_DOG_TYPE_7G_1/2	送り歯糸切りG 1/2	1
9		400-71912	FEED_DOG_7G_5/8	糸切り送り歯G_5/8	1
10		400-35895	FEED_DOG_TYPE_7G_3/4	送り歯糸切りG 3/4	1
11		400-71913	FEED_DOG_7G_7/8	糸切り送り歯G_7/8	1
12		400-71914	FEED_DOG_7G_1	糸切り送り歯G_1	1
13		400-53705	FEED_DOG_TYPE_7G_1/8	送り歯糸切りG 1/8	1
14		400-25831	FEED_DOG_TYPE_7G_3/16	送り歯糸切りG 3/16	1
15		400-25832	FEED_DOG_TYPE_7G_7/32	送り歯糸切りG 7/32	1
16		400-25833	FEED_DOG_TYPE_7G_1/4	送り歯糸切りG 1/4	1
17		400-25834	FEED_DOG_TYPE_7G_9/32	送り歯糸切りG 9/32	1
18		400-25835	FEED_DOG_TYPE_7G_5/16	送り歯糸切りG 5/16	1
19		400-25836	FEED_DOG_TYPE_7G_3/8	送り歯糸切りG 3/8	1
20		400-25838	FEED_DOG_TYPE_7G_1/2	送り歯糸切りG 1/2	1
21		400-25839	FEED_DOG_TYPE_7G_5/8	送り歯糸切りG 5/8	1
22		400-25840	FEED_DOG_TYPE_7G_3/4	送り歯糸切りG 3/4	1
23		400-25841	FEED_DOG_TYPE_7G_7/8	送り歯糸切りG 7/8	1
24		400-25842	FEED_DOG_TYPE_7G_1	送り歯糸切りG 1	1
25		400-35881	THROAT_PLATE_TRIM 1/8	糸切り針板 1/8	1
26		400-25485	THROAT_PLATE_TRIM 5/32	糸切り針板 5/32	1
27		400-95289	THROAT_PLATE_TRIM 3/16	針板(糸切り) 3/16	1
28		400-25491	THROAT_PLATE_TRIM-7/32	糸切り針板-7/32	1
29		400-94773	THROAT_PLATE_TRIM 1/4	針板糸切り	1
30		400-25493	THROAT_PLATE_TRIM-9/32	糸切り針板-9/32	1
31		400-25494	THROAT_PLATE_TRIM-5/16	糸切り針板-5/16	1
32		400-25495	THROAT_PLATE_TRIM-3/8	糸切り針板-3/8	1
33		400-25498	THROAT_PLATE_TRIM-1/2	糸切り針板-1/2	1
34		400-25499	THROAT_PLATE_TRIM-5/8	糸切り針板-5/8	1
35		400-25500	THROAT_PLATE_TRIM-3/4	糸切り針板-3/4	1
36		400-25502	THROAT_PLATE_TRIM-7/8	糸切り針板-7/8	1
37		400-25503	THROAT_PLATE_TRIM-1	糸切り針板-1	1
38		400-35896	PRESSER FOOT ASM.	先割自由押え(組) 1/8	1
39		400-71909	PRESSER_FOOT_ASM_G_5/32	先割自由押えG(組) 5/32	1
40		228-16557	TIP-DIVIDED PRESSER ASM. 3/16	先割自由押え2.4(組) 3/16"	1
41		228-16656	TIP-DIVIDED PRESSER ASM. 7/32	先割自由押え2.4(組) 7/32"	1
42		228-16755	PRESSER FOOT ASM. 1/4"	先割自由押え2.4(組) 1/4"	1
43		228-16854	TIP-DIVIDED PRESSER ASM. 9/32	先割自由押え2.4(組) 9/32"	1
44		228-16953	TIP-DIVIDED PRESSER ASM. 5/16	先割自由押え2.4(組) 5/16"	1
45		228-17050	PRESSER FOOT ASM. D=2.4(3/8)	先割自由押え2.4(組) 3/8"	1
46		228-17159	PRESSER FOOT ASM. D=2.4(1/2)	先割自由押え2.4(組) 1/2"	1
47		400-33945	TIP-DIVIDED_PRESSER_ASM_5/8	先割自由押え(組) 5/8	1
48		400-33947	TIP-DIVIDED_PRESSER_ASM_3/4	先割自由押え(組) 3/4	1
49		400-33949	TIP-DIVIDED_PRESSER_ASM_7/8	先割自由押え(組) 7/8	1
50		400-33951	TIP-DIVIDED_PRESSER_ASM_1	先割自由押え(組) 1	1
51	#01	400-95293	ASSY_PRESSER_FOOT_G3/16	スィブルガイド押え3/16	1
52	#01	400-94776	ASSY_PRESSER_FOOT_G1/4	スィブルガイド押え	1
53		B1402-528-BA0-A	NEEDLE CLAMP ASM. 1/8	針留 1/8組	1
54		B1402-528-CA0-A	NEEDLE CLAMP ASM. 5/32	針留 5/32組	1
55		B1402-528-DAL-A	NEEDLE CLAMP ASM. LEFT	針留左 3/16組	1
56		B1402-528-EAL	NEEDLE CLAMP ASM. 7/32	針留左 7/32組	1
57		B1402-528-FAL-A	NEEDLE CLAMP ASM. 1/4	針留左 1/4組	1
58		B1402-528-GAL	NEEDLE CLAMP ASM. LEFT	針留左組	1
59		B1402-528-HAL-A	NEEDLE CLAMP ASM. 5/16	針留左 5/16組	1
60		B1402-528-KAL-A	NEEDLE CLAMP ASM. 3/8	針留左 3/8組	1
61		B1402-528-LAL	NEEDLE CLAMP ASM., LEFT 1/2"	針留左 1/2組	1
62		B1402-528-MAL	NEEDLE CLAMP ASM., LEFT 5/8"	針留左 5/8組	1
63		B1402-528-NAL	NEEDLE CLAMP ASM., LEFT 3/4"	針留左 3/4組	1
64		B1402-528-PAL	NEEDLE CLAMP ASM. LEFT 7/8"	針留(左)組 7/8	1
65		B1402-528-QAL	NEEDLE CLAMP ASM., LEFT 1"	針留左 1組	1
66		B1402-528-DAR-A	NEEDLE CLAMP ASM. RIGHT	針留右 3/16組	1
67		B1402-528-EAR	NEEDLE CLAMP ASM. 7/32	針留右 7/32組	1
68		B1402-528-FAR-A	NEEDLE CLAMP ASM. 1/4	針留右 1/4組	1
69		B1402-528-GAR	NEEDLE CLAMP ASM., RIGHT	針留右組	1
70		B1402-528-HAR-A	NEEDLE CLAMP ASM. 5/16	針留右 5/16組	1
71		B1402-528-KAR-A	NEEDLE CLAMP ASM. 3/8	針留右 3/8組	1
72		B1402-528-LAR	NEEDLE CLAMP ASM., RIGHT 1/2"	針留右 1/2組	1
73		B1402-528-MAR	NEEDLE CLAMP ASM., RIGHT 5/8"	針留右 5/8組	1
74		B1402-528-NAR	NEEDLE CLAMP ASM., RIGHT 3/4"	針留右 3/4組	1
75		B1402-528-PAR	NEEDLE CLAMP ASM. RIGHT 7/8"	針留(右)組 7/8	1
76		B1402-528-QAR	NEEDLE CLAMP ASM., RIGHT 1"	針留右 1組	1
77		B1402-526-BA0-A	NEEDLE CLAMP ASM. 1/8"	針留 1/8組	1
78		B1402-526-CA0-A	NEEDLE CLAMP ASM. 5/32"	針留 5/32組	1
79		B1402-526-DAL-A	NEEDLE CLAMP LEFT ASM. 3/16"	針留左 3/16組	1
80		102-28559	NEEDLE CLAMP ASM. LEFT 7/32	針留左組 7/32	1
81		B1402-526-FAL-A	NEEDLE CLAMP LEFT ASM. 1/4	針留左 1/4組	1
82		B1402-526-GAL-A	NEEDLE CLAMP LEFT ASM. 9/32"	針留左 9/32組	1
83		B1402-526-HAL-A	NEEDLE CLAMP LEFT ASM. 5/16"	針留左 5/16組	1
84		B1402-526-KAL-A	NEEDLE CLAMP LEFT ASM. 3/8"	針留左 3/8組	1
85		B1402-526-LAL-A	NEEDLE CLAMP LEFT ASM.	針留左 1/2組	1
86		102-28856	NEEDLE CLAMP ASM. LEFT 5/8	針留左組 5/8	1
87		102-28955	NEEDLE CLAMP ASM. LEFT 3/4	針留左組 3/4	1
88		102-29151	NEEDLE CLAMP ASM. LEFT 1"	針留左組 1	1
89		B1402-526-DAR-A	NEEDLE CLAMP RIGHT ASM. 3/16"	針留右 3/16組	1
90		102-28567	NEEDLE CLAMP ASM. RIGHT 7/32	針留右組 7/32	1
91		B1402-526-FAR-A	NEEDLE CLAMP RIGHT ASM. 1/4	針留右 1/4組	1
92		B1402-526-GAR-A	NEEDLE CLAMP RIGHT ASM. 9/32"	針留右 9/32組	1
93		B1402-526-HAR-A	NEEDLE CLAMP RIGHT ASM. 5/16"	針留右 5/16組	1
94		B1402-526-KAR-A	NEEDLE CLAMP RIGHT ASM. 3/8"	針留右 3/8組	1
95		B1402-526-LAR-A	NEEDLE CLAMP RIGHT ASM.	針留右 1/2組	1
96		102-28864	NEEDLE CLAMP ASM. RIGHT 5/8	針留右組 5/8	1
97		102-28963	NEEDLE CLAMP ASM. RIGHT 3/4	針留右組 3/4	1
98		102-29169	NEEDLE CLAMP ASM. RIGHT 1"	針留右組 1	1
99		400-25247	ASSY_SLIDE_PLATE-L-A	糸切り滑り板-左-A-組	1
100		400-25248	ASSY_SLIDE_PLATE-L-B	糸切り滑り板-左-B-組	1
101		400-25249	ASSY_SLIDE_PLATE-L-C	糸切り滑り板-左-C-組	1
102		400-25235	ASSY_SLIDE_PLATE-R-A	糸切り滑り板-右-A-組	1
103		400-25236	ASSY_SLIDE_PLATE-R-B	糸切り滑り板-右-B-組	1
104		400-25239	ASSY_SLIDE_PLATE-R-C	糸切り滑り板-右-C-組	1
105		400-51633	ASSY_SLIDE_PLATE_L	はね上げ式滑り板組	1
106		400-45729	ASSY_SIDE_PLATE-L-B	滑り板左組	1
107		400-45730	ASSY_SIDE_PLATE-L-C	滑り板左組	1
108		400-42880	ASSY_SLIDE_PLATE_F	滑り板前糸切り付き組	1
109	#02	402-29461	ASSY_PRESSER_FOOT_G3/16	スィブルガイド押え3/16"	1
110	#02	402-29459	ASSY_PRESSER_FOOT_G_1/4	スィブルガイド押えG(組) 1/4"	1

NOTE(注記)

#01...EDGE 3mm
#02...EDGE 2mm

コバ 3mm
コバ 2mm

NUMERICAL INDEX OF PARTS

索引

PART NO 品番	PAGE 頁	REF NO	PART NO 品番	PAGE 頁	REF NO	PART NO 品番	PAGE 頁	REF NO	PART NO 品番	PAGE 頁	REF NO
A4078-009-000	32	49	B1402-526-LAL-A	52	177	B1402-528-KAR-A	50	45	B1613-512-H0H	56	64
A4078-009-000	34	107	B1402-526-LAL-A	56	9	B1402-528-KAR-A	52	135	B1613-512-K0H	46	68
			B1402-526-LAL-A	60	85	B1402-528-KAR-A	56	41	B1613-512-K0H	50	154
BP-3000001-0R	22	17	B1402-526-LAR-A	50	97	B1402-528-KAR-A	60	71	B1613-512-K0H	54	8
BP-3000001-0R	32	1	B1402-526-LAR-A	52	187	B1402-528-LAL	50	35	B1613-512-K0H	56	65
BP-3000001-0R	32	2	B1402-526-LAR-A	56	19	B1402-528-LAL	52	125	B1613-512-L0H	46	70
BP-3000001-0R	32	3	B1402-526-LAR-A	60	95	B1402-528-LAL	56	31	B1613-512-L0H	50	155
BP-3000001-0R	32	40	B1402-528-BA0-A	50	27	B1402-528-LAL	60	61	B1613-512-L0H	54	10
BP-3000001-0R	32	54	B1402-528-BA0-A	52	117	B1402-528-LAR	50	46	B1613-512-L0H	56	66
BP-3000001-0R	32	65	B1402-528-BA0-A	56	23	B1402-528-LAR	52	136	B1613-512-M0H	46	71
BP-3000001-0R	32	68	B1402-528-BA0-A	60	53	B1402-528-LAR	56	42	B1613-512-M0H	50	156
BP-3000001-0R	32	96	B1402-528-CA0-A	50	28	B1402-528-LAR	60	72	B1613-512-M0H	54	11
BP-3000001-0R	32	97	B1402-528-CA0-A	52	118	B1402-528-MAL	50	36	B1613-512-M0H	56	67
BP-3000001-0R	32	98	B1402-528-CA0-A	56	24	B1402-528-MAL	52	126	B1613-512-N0H	46	72
BP-3000001-0R	34	1	B1402-528-CA0-A	60	54	B1402-528-MAL	56	32	B1613-512-N0H	50	157
BP-3000001-0R	34	2	B1402-528-DAL-A	50	3	B1402-528-MAL	60	62	B1613-512-N0H	54	12
BP-3000001-0R	34	3	B1402-528-DAL-A	50	29	B1402-528-MAR	50	47	B1613-512-N0H	56	68
BP-3000001-0R	34	40	B1402-528-DAL-A	52	95	B1402-528-MAR	52	137	B1613-512-P0H	46	73
BP-3000001-0R	34	54	B1402-528-DAL-A	52	119	B1402-528-MAR	56	43	B1613-512-P0H	50	158
BP-3000001-0R	34	65	B1402-528-DAL-A	56	25	B1402-528-MAR	60	73	B1613-512-P0H	54	13
BP-3000001-0R	34	68	B1402-528-DAL-A	60	55	B1402-528-NAL	50	37	B1613-512-P0H	56	69
BP-3000001-0R	34	84	B1402-528-DAR-A	50	16	B1402-528-NAL	52	127	B1613-512-Q0H	46	74
BP-3000001-0R	34	85	B1402-528-DAR-A	50	40	B1402-528-NAL	56	33	B1613-512-Q0H	50	159
BP-3000001-0R	34	96	B1402-528-DAR-A	52	107	B1402-528-NAL	60	63	B1613-512-Q0H	54	14
B1104-051-000	2	26	B1402-528-DAR-A	52	130	B1402-528-NAR	50	48	B1613-512-Q0H	56	70
B1116-210-D00	37	9	B1402-528-DAR-A	56	36	B1402-528-NAR	52	138	B1613-512-R0H	46	75
B1402-526-BA0-A	50	79	B1402-528-DAR-A	60	66	B1402-528-NAR	56	44	B1613-512-R0H	54	15
B1402-526-BA0-A	52	169	B1402-528-EAL	50	4	B1402-528-NAR	60	74	B1613-512-S0H	46	76
B1402-526-BA0-A	56	1	B1402-528-EAL	50	30	B1402-528-PAL	50	38	B1613-512-S0H	54	16
B1402-526-BA0-A	60	77	B1402-528-EAL	52	96	B1402-528-PAL	52	128	B1613-512-T0H	46	77
B1402-526-CA0-A	50	80	B1402-528-EAL	52	120	B1402-528-PAL	56	34	B1613-512-T0H	54	17
B1402-526-CA0-A	52	170	B1402-528-EAL	56	26	B1402-528-PAL	60	64	B1613-512-U0H	46	78
B1402-526-CA0-A	56	2	B1402-528-EAL	60	56	B1402-528-PAR	50	49	B1613-512-U0H	54	18
B1402-526-CA0-A	60	78	B1402-528-EAR	50	17	B1402-528-PAR	52	139	B1636-581-B00	22	33
B1402-526-DAL-A	50	81	B1402-528-EAR	50	41	B1402-528-PAR	56	45	B1653-470-000	22	24
B1402-526-DAL-A	52	171	B1402-528-EAR	52	108	B1402-528-PAR	60	75	B1705-850-000	8	68
B1402-526-DAL-A	56	3	B1402-528-EAR	52	131	B1402-528-QAL	50	39	B1821-051-000	16	72
B1402-526-DAL-A	60	79	B1402-528-EAR	56	37	B1402-528-QAL	52	129	B1821-051-000	18	10
B1402-526-DAR-A	50	91	B1402-528-EAR	60	67	B1402-528-QAL	56	35	B1822-051-000	16	85
B1402-526-DAR-A	52	181	B1402-528-FAL-A	8	84	B1402-528-QAL	60	65	B1823-051-000	16	20
B1402-526-DAR-A	56	13	B1402-528-FAL-A	50	5	B1402-528-QAR	50	50	B1823-051-000	18	17
B1402-526-DAR-A	60	89	B1402-528-FAL-A	50	31	B1402-528-QAR	52	140	B1834-512-000	32	72
B1402-526-FAL-A	50	83	B1402-528-FAL-A	52	97	B1402-528-QAR	56	46	B1834-512-000	34	72
B1402-526-FAL-A	52	173	B1402-528-FAL-A	52	121	B1402-528-QAR	60	76	B3111-126-000	12	33
B1402-526-FAL-A	56	5	B1402-528-FAL-A	56	27	B1425-526-000	8	34	B3112-704-000	10	21
B1402-526-FAL-A	60	81	B1402-528-FAL-A	60	57	B1438-512-B00	6	9	B3112-704-000	14	21
B1402-526-FAR-A	50	93	B1402-528-FAR-A	8	86	B1438-512-B00	8	51	B3114-232-000	10	20
B1402-526-FAR-A	52	183	B1402-528-FAR-A	50	18	B1449-526-000	14	43	B3114-232-000	14	20
B1402-526-FAR-A	56	15	B1402-528-FAR-A	50	42	B1505-227-T00-A	24	36	B3115-552-000	12	32
B1402-526-FAR-A	60	91	B1402-528-FAR-A	52	109	B1521-555-000	24	2	B3118-552-F00	12	45
B1402-526-GAL-A	50	84	B1402-528-FAR-A	52	132	B1613-512-B0H	46	61	B3118-552-I00	12	46
B1402-526-GAL-A	52	174	B1402-528-FAR-A	56	38	B1613-512-B0H	54	1	B3120-125-000	12	34
B1402-526-GAL-A	56	6	B1402-528-FAR-A	60	68	B1613-512-C0H	46	62	B3126-012-000	10	17
B1402-526-GAL-A	60	82	B1402-528-GAL	50	32	B1613-512-C0H	50	148	B3126-012-000	14	17
B1402-526-GAR-A	50	94	B1402-528-GAL	52	122	B1613-512-C0H	54	2	B3129-012-A00	10	19
B1402-526-GAR-A	52	184	B1402-528-GAL	56	28	B1613-512-C0H	56	59	B3129-012-A00	12	17
B1402-526-GAR-A	56	16	B1402-528-GAL	60	58	B1613-512-D0H	46	63	B3129-012-A00	14	19
B1402-526-GAR-A	60	92	B1402-528-GAR	50	43	B1613-512-D0H	50	149	B3132-552-000	12	38
B1402-526-HAL-A	50	85	B1402-528-GAR	52	133	B1613-512-D0H	54	3	B3137-527-0A0	10	5
B1402-526-HAL-A	52	175	B1402-528-GAR	56	39	B1613-512-D0H	56	60	B3137-527-0A0	14	5
B1402-526-HAL-A	56	7	B1402-528-GAR	60	69	B1613-512-E0H	46	64	B3138-527-000	10	9
B1402-526-HAL-A	60	83	B1402-528-HAL-A	50	33	B1613-512-E0H	50	150	B3138-527-000	14	9
B1402-526-HAR-A	50	95	B1402-528-HAL-A	52	123	B1613-512-E0H	54	4	B3139-527-000	10	7
B1402-526-HAR-A	52	185	B1402-528-HAL-A	56	29	B1613-512-E0H	56	61	B3139-527-000	14	7
B1402-526-HAR-A	56	17	B1402-528-HAL-A	60	59	B1613-512-F0H	46	65	B3141-527-000	10	12
B1402-526-HAR-A	60	93	B1402-528-HAR-A	50	44	B1613-512-F0H	50	151	B3141-527-000	14	12
B1402-526-KAL-A	50	86	B1402-528-HAR-A	52	134	B1613-512-F0H	54	5	B3142-527-000	10	6
B1402-526-KAL-A	52	176	B1402-528-HAR-A	56	40	B1613-512-F0H	56	62	B3142-527-000	14	6
B1402-526-KAL-A	56	8	B1402-528-HAR-A	60	70	B1613-512-G0H	46	66	B3143-527-000	10	14
B1402-526-KAL-A	60	84	B1402-528-KAL-A	50	8	B1613-512-G0H	50	152	B3143-527-000	14	14
B1402-526-KAR-A	50	96	B1402-528-KAL-A	50	34	B1613-512-G0H	54	6	B3214-047-000	12	8
B1402-526-KAR-A	52	186	B1402-528-KAL-A	52	124	B1613-512-G0H	56	63	B3517-009-000	32	43
B1402-526-KAR-A	56	18	B1402-528-KAL-A	56	30	B1613-512-H0H	46	67	B3517-009-000	34	43
B1402-526-KAR-A	60	94	B1402-528-KAL-A	60	60	B1613-512-H0H	50	153	B3525-357-000	32	9
B1402-526-LAL-A	50	87	B1402-528-KAR-A	50	21	B1613-512-H0H	54	7	B3525-357-000	32	58

NUMERICAL INDEX OF PARTS

索引

PART NO 品番	PAGE 頁	REF NO	PART NO 品番	PAGE 頁	REF NO	PART NO 品番	PAGE 頁	REF NO	PART NO 品番	PAGE 頁	REF NO
B3525-357-000	34	9	NM-6040002-SC	40	27	SD-0800352-SP	38	14	SM-6050800-SP	22	93
B3525-357-000	34	58	NM-6040003-SC	14	75	SD-0900356-TP	24	15	SM-6050802-TP	30	26
B3561-771-000	34	102	NM-6050001-SD	14	70	SD-0900426-TP	22	4	SM-6051002-TP	4	49
B8228-125-000	32	18	NM-6050001-SD	36	44	SD-0900706-TP	22	55	SM-6051002-TP	6	21
B8228-125-000	34	18	NM-6050001-SE	40	28	SK-3412000-SC	36	12	SM-6051002-TP	28	50
B9101-490-000	42	8	NM-6050001-SP	22	28	SL-4030631-SC	30	3	SM-6051202-TP	14	51
B9117-051-000	16	21	NM-6050001-SP	28	13	SL-4030641-SE	30	18	SM-6051202-TP	26	34
B9117-051-000	42	20	NM-6060001-CP	6	45	SL-6052592-TN	4	30	SM-6051202-TP	26	37
B9117-563-000	18	18	NM-6060001-CP	8	95	SL-6061692-TN	2	48	SM-6051202-TP	32	8
B9117-563-000	42	38	NM-6060001-CP	14	66	SM-0050801-SC	36	37	SM-6051202-TP	34	8
B9121-012-0A0	42	21	NM-6060001-CP	22	54	SM-1030601-SN	26	41	SM-6051400-SP	22	41
			NM-6060001-SE	37	5	SM-1030601-SN	26	44	SM-6051600-SP	6	28
CM-2001001-01	2	69	NM-6060003-SC	26	18	SM-1040750-TP	2	21	SM-6051600-SP	8	81
CM-2001001-02	2	68	NS-6080210-SP	12	22	SM-1040750-TP	2	25	SM-6051600-SP	22	6
CM-2002002-01	2	52	NS-6090310-SP	30	22	SM-1040750-TP	2	30	SM-6051600-SP	22	52
CM-2002002-02	2	53	NS-6110310-SP	10	30	SM-2040750-TP	2	32	SM-6051600-SP	22	74
CM-3002000-01	2	49	NS-6110310-SP	12	23	SM-4021201-SC	28	44	SM-6051850-TP	22	83
CM-3002000-03	2	70	NS-6110310-SP	14	30	SM-40405C5-SP	32	6	SM-6052002-TP	20	51
CM-3004009-01	14	67	NS-6110310-SP	30	9	SM-40405C5-SP	34	6	SM-6052502-TP	26	62
CM-3004009-02	14	52	NS-6110310-SP	32	99	SM-4040601-SC	26	5	SM-6060800-SP	2	12
CM-3011001-01	2	56	NS-6110310-SP	34	48	SM-4040655-SP	22	21	SM-6060800-SP	24	39
CM-3011001-02	2	55	NS-6110420-SP	16	19	SM-4040655-SP	24	44	SM-6060802-TP	6	46
CM-3013000-01	2	7	NS-6110420-SP	18	16	SM-4040655-SP	32	21	SM-6060802-TP	8	96
CM-6001002-01	42	30	NS-6150310-SP	38	5	SM-4040655-SP	32	23	SM-6061150-TP	4	20
CQ-2020000-00	4	3	NS-6150440-SP	38	11	SM-4040655-SP	34	21	SM-6061200-SP	26	28
CQ-2020000-00	4	5	NS-6620310-SP	24	27	SM-4040655-SP	34	23	SM-6061202-TP	28	24
CQ-2020000-00	16	18				SM-4040855-SP	14	49	SM-6062500-SP	20	31
CQ-2020000-00	16	81	RC-0370411-KP	30	27	SM-4040855-SP	22	31	SM-6062502-TP	6	24
CQ-2020000-00	18	14	RC-0650811-KP	26	3	SM-4040855-SP	24	47	SM-6062502-TP	8	76
CQ-2020000-00	18	15	RE-0400000-K0	28	23	SM-4041055-SP	6	35	SM-6063002-TP	28	29
CQ-2520000-00	4	7	RE-0500000-K0	24	10	SM-4041201-SC	40	24	SM-6063750-SP	20	24
CQ-2520000-00	6	36	RE-0500000-K0	24	13	SM-4041601-SN	12	49	SM-6750690-TP	22	25
CQ-2520000-00	8	70	RE-0500000-K0	36	31	SM-4042501-SC	40	26	SM-6850400-SP	26	53
CQ-3030000-00	4	12	RE-0500000-K0	38	18	SM-4050655-SP	22	85	SM-7050850-TP	22	48
CQ-3030000-00	34	97	RE-0600000-K0	26	11	SM-4050655-SP	32	57	SM-7050850-TP	22	60
CS-087101B-SH	6	42	RE-0700000-K0	14	56	SM-4050655-SP	34	57	SM-7050850-TP	22	95
CS-087101B-SH	8	92	RE-0700000-K0	38	13	SM-4050855-SP	2	4	SM-8030312-TP	26	54
CS-0871019-SH	6	43	RE-0800000-K0	38	20	SM-4050855-SP	2	6	SM-8031612-TP	22	77
CS-0871019-SH	8	93	RE-0900000-K0	22	13	SM-4050855-SP	12	47	SM-8040412-TP	2	23
			RE-1000000-K0	37	13	SM-4050855-SP	14	58	SM-8040412-TP	14	68
D2112-555-B00	2	3	RO-0360802-00	10	40	SM-4050855-SP	20	28	SM-8040412-TP	22	23
D2464-555-B00	28	22	RO-0360802-00	14	40	SM-4050855-SP	20	34	SM-8040412-TP	22	76
D3128-555-D00	12	36	RO-0371801-00	24	3	SM-4050855-SP	26	14	SM-8040412-TP	36	36
D3129-555-D00	12	37	RO-0371801-00	32	62	SM-4050855-SP	26	26	SM-8040612-TP	22	38
D3159-555-B00	24	26	RO-0371801-00	34	62	SM-4050855-SP	30	20	SM-8040802-TP	14	74
D3164-555-B00	24	45	RO-0442401-00	20	17	SM-4050855-SP	32	88	SM-8050412-TP	2	19
			RO-0481901-00	32	20	SM-4050855-SP	32	94	SM-8050412-TP	22	46
EA-9500B01-00	26	59	RO-0481901-00	32	86	SM-4050855-SP	34	88	SM-8050502-TP	36	35
EA-9500B01-00	26	63	RO-0481901-00	34	20	SM-4050855-SP	34	94	SM-80506A2-TP	22	11
EA-9500B01-00	28	10	RO-0481901-00	34	86	SM-4051001-SN	10	43	SM-80506A2-TP	22	14
EA-9500B01-00	28	45	RO-0922702-00	22	78	SM-4051001-SN	14	48	SM-8050612-TP	12	20
EA-9500B01-00	32	91	RO-1952401-00	32	11	SM-4051055-SP	2	67	SM-8050812-TP	24	18
EA-9500B01-00	34	91	RO-1952401-00	32	42	SM-4051255-SP	2	1	SM-8051002-TP	20	20
EA-9500B02-00	32	74	RO-1952401-00	34	11	SM-4051255-SP	22	27	SM-8051610-SP	4	28
EA-9500B02-00	32	92	RO-1952401-00	34	42	SM-4051405-SE	40	25	SM-8060550-TP	16	34
EA-9500B02-00	34	74	RO-2573501-00	20	42	SM-4051601-SC	36	4	SM-8060550-TP	18	28
EA-9500B02-00	34	92				SM-4052501-SN	10	42	SM-8060552-TP	4	14
			SB-1170001-00	4	47	SM-4052501-SN	14	47	SM-8060552-TP	22	82
GAK-33027000	38	7	SB-1200025-00	4	37	SM-4055501-SC	32	79	SM-8060610-TP	20	37
			SB-3095301-0A	18	30	SM-4055501-SC	34	79	SM-8060612-TP	4	15
HK-0346101-40	28	14	SB-3095301-0B	18	31	SM-4062001-SC	36	3	SM-8060612-TP	20	5
HK-0346400-0B	28	19	SB-3095301-0C	18	32	SM-5040655-SN	36	34	SM-8060612-TP	20	41
			SB-3095301-0D	18	33	SM-6030672-TP	22	34	SM-80608A2-TP	4	25
MDP-500B0902	42	10	SD-0470316-TP	10	27	SM-6040602-TP	24	7	SM-80608A2-TP	4	38
MDP-500B1002	42	11	SD-0470316-TP	12	3	SM-6040650-TP	32	63	SM-80608A2-TP	20	38
MDP-500B1400	6	3	SD-0470316-TP	14	27	SM-6040650-TP	32	73	SM-80608A2-TP	20	39
MDP-500B1400	8	4	SD-0500301-SP	30	23	SM-6040650-TP	34	63	SM-80608A2-TP	22	29
MDP-500B1402	42	12	SD-0601171-SP	14	42	SM-6040650-TP	34	103	SM-80608A2-TP	22	44
MDP-500B2100	6	4	SD-0640247-TP	14	60	SM-6040655-TP	2	31	SM-80608A2-TP	26	61
MDP-500B2100	8	5	SD-0640357-TP	24	14	SM-6041002-TP	22	92	SM-8061212-TP	14	65
MDP-500B2102	42	13	SD-0640752-TP	14	53	SM-6041802-TP	32	71	SM-8061550-TP	4	22
			SD-0650321-TP	30	4	SM-6041802-TP	34	71	SM-8063012-TR	37	6
NM-6030001-SC	26	7	SD-0700328-TP	28	34	SM-6050450-TP	14	73	SM-8081652-TP	4	17
NM-6030001-SN	22	79	SD-0700336-TP	26	75	SM-6050650-TP	28	35	SM-9040603-SC	2	28
NM-6040001-SP	22	69	SD-0700346-TP	26	65	SM-6050800-SP	22	1	SM-9040603-SC	28	12

NUMERICAL INDEX OF PARTS

索引

PART NO 品番	PAGE 頁	REF NO	PART NO 品番	PAGE 頁	REF NO	PART NO 品番	PAGE 頁	REF NO	PART NO 品番	PAGE 頁	REF NO
SM-9050850-SP	26	21	TA-1250406-R0	2	10	101-12902	16	28	101-49151	46	136
SM-9050850-SP	26	31	TA-1250406-R0	2	11	101-12902	16	54	101-49151	48	49
SM-9051203-CP	26	57	TA-1250406-R0	2	73	101-12902	16	59	101-49151	54	51
SM-9061203-SE	37	20	TA-1250705-R0	2	62	101-19204	28	36	101-49151	58	33
SM-9061853-SR	37	14	TA-1470704-R0	2	57	101-24204	10	28	101-49250	46	137
SQ-0000401-MZ	32	12	TA-1600406-R0	2	16	101-24204	14	28	101-49250	48	50
SQ-0000401-MZ	32	60	TA-1650406-R0	2	59	101-24303	10	29	101-49250	54	52
SQ-0000401-MZ	34	12				101-24303	14	29	101-49250	58	34
SQ-0000401-MZ	34	60	WP-0350516-SD	12	27	101-26803	32	51	101-49359	46	138
SQ-0000451-MZ	32	27	WP-0371016-SD	16	80	101-26803	34	51	101-49359	48	51
SQ-0000451-MZ	34	27	WP-0371016-SD	18	13	101-47551	46	125	101-49359	54	53
SQ-2050453-MZ	20	29	WP-0371016-SD	30	30	101-47551	48	36	101-49359	58	35
SQ-2050453-MZ	20	45	WP-0430800-SD	32	70	101-47551	54	35	102-09203	30	31
SQ-2060443-SD	32	25	WP-0430800-SD	34	70	101-47551	58	17	102-09500	30	32
SQ-2060443-SD	34	25	WP-0450000-SD	8	18	101-47650	46	126	102-09807	30	33
SQ-2060451-MZ	20	35	WP-0450801-SP	14	44	101-47650	48	37	102-09906	30	34
SS-1090520-TP	26	47	WP-0450801-SP	28	49	101-47650	54	36	102-10805	16	82
SS-4090415-SP	8	28	WP-0501016-SC	36	13	101-47650	58	18	102-10805	42	19
SS-4090715-SP	8	16	WP-0501016-SD	4	50	101-47759	46	127	102-28559	50	82
SS-4090715-SP	8	37	WP-0501016-SD	10	37	101-47759	48	38	102-28559	52	172
SS-4110515-SP	28	47	WP-0501016-SD	14	37	101-47759	54	37	102-28559	56	4
SS-4110615-SP	10	36	WP-0501016-SD	28	16	101-47759	58	19	102-28559	60	80
SS-4110615-SP	14	36	WP-0501016-SD	28	20	101-47858	46	172	102-28567	50	92
SS-4110715-SP	24	29	WP-0520656-SA	22	16	101-47858	48	164	102-28567	52	182
SS-4111215-SP	24	31	WP-0520656-SA	32	78	101-47858	54	38	102-28567	56	14
SS-5090420-SP	10	39	WP-0520656-SA	34	78	101-47858	58	20	102-28567	60	90
SS-5090420-SP	14	39	WP-0531000-SC	42	3	101-47957	46	128	102-28856	50	88
SS-5091020-SP	12	21	WP-0531000-SD	26	22	101-47957	48	39	102-28856	52	178
SS-6060510-TP	8	22	WP-0531000-SD	26	32	101-47957	54	39	102-28856	56	10
SS-6080340-SP	8	63	WP-0531000-SD	26	66	101-47957	58	21	102-28856	60	86
SS-6080410-SP	8	27	WP-0531000-SD	30	35	101-48054	6	18	102-28864	50	98
SS-6090520-SP	12	25	WP-0531000-SD	32	80	101-48054	46	173	102-28864	52	188
SS-6090580-TP	26	48	WP-0531000-SD	34	80	101-48054	48	165	102-28864	56	20
SS-6090810-TP	16	79	WP-0531001-SC	36	6	101-48054	54	40	102-28864	60	96
SS-6090810-TP	18	12	WP-0550800-SP	6	22	101-48054	58	22	102-28955	50	89
SS-6121860-SP	22	19	WP-0550800-SP	28	51	101-48153	46	129	102-28955	52	179
SS-6153040-SP	20	23	WP-0550800-SP	32	95	101-48153	48	40	102-28955	56	11
SS-6560150-SH	16	17	WP-0550800-SP	34	95	101-48153	54	41	102-28955	60	87
SS-6560150-SH	16	47	WP-0600816-SP	28	31	101-48153	58	23	102-28963	50	99
SS-7060310-SP	8	72	WP-0621016-SD	28	26	101-48252	46	174	102-28963	52	189
SS-7090510-SP	10	24	WP-0621036-SP	38	10	101-48252	48	41	102-28963	56	21
SS-7090510-SP	14	24	WP-0621046-SP	20	25	101-48252	54	42	102-28963	60	97
SS-7090610-SP	30	29	WP-0621046-SP	26	17	101-48252	58	24	102-29151	50	90
SS-7090910-TP	24	43	WP-0641600-SC	36	7	101-48351	46	175	102-29151	52	180
SS-7110710-SP	8	19	WP-0651646-SC	42	16	101-48351	48	166	102-29151	56	12
SS-7110710-SP	28	15	WP-1021016-SD	38	12	101-48351	54	43	102-29151	60	88
SS-7110740-TP	28	11	WS-0410002-KP	30	21	101-48351	58	25	102-29169	50	100
SS-7121410-TP	38	6	WS-0451040-KP	28	48	101-48450	46	130	102-29169	52	190
SS-8080660-TP	6	17	WS-0510002-KN	40	5	101-48450	48	42	102-29169	56	22
SS-8080660-TP	6	19	WS-0521010-KN	36	5	101-48450	54	44	102-29169	60	98
SS-8080660-TP	8	36	WS-0610002-KP	28	30	101-48450	58	26	103-91852	44	50
SS-8080660-TP	8	43	WS-0631510-KP	28	25	101-48559	46	131	103-92058	44	51
SS-8080660-TP	8	85				101-48559	48	43	103-92256	44	52
SS-8080660-TP	8	87	101-09809	18	4	101-48559	54	45	103-92751	44	53
SS-8090670-SP	12	19	101-09908	20	21	101-48559	58	27	103-93056	44	54
SS-8090670-SP	12	39	101-10500	16	13	101-48658	46	132	106-97506	10	35
SS-8110410-TP	2	76	101-10500	16	32	101-48658	48	44	106-97506	14	35
SS-8150822-TP	6	44	101-10500	16	45	101-48658	54	46	106-97605	10	3
SS-8150822-TP	8	94	101-10500	16	64	101-48658	58	28	106-97605	14	3
SS-9110460-CP	14	62	101-10609	16	33	101-48757	46	133	107-41106	10	31
SS-9111010-SP	28	21	101-10609	16	65	101-48757	48	45	107-41106	14	31
ST-4030651-SN	36	27	101-11003	18	6	101-48757	54	47	110-02904	8	1
			101-11102	18	7	101-48757	58	29	110-15906	16	7
TA-0290301-M0	20	19	101-11201	18	3	101-48856	46	134	110-15906	16	26
TA-0290301-M0	20	30	101-11508	16	83	101-48856	48	46	110-15906	16	52
TA-0370301-R0	4	33	101-11508	42	18	101-48856	54	48	110-15906	16	69
TA-0370301-R0	6	29	101-12407	20	22	101-48856	58	30	110-15906	18	36
TA-0370301-R0	8	33	101-12506	18	5	101-48955	46	176	110-15906	18	42
TA-0490601-R0	4	42	101-12605	16	38	101-48955	48	47	110-45101	10	32
TA-0500301-R0	4	32	101-12704	16	39	101-48955	54	49	110-45101	14	32
TA-0750404-R0	4	1	101-12803	16	16	101-48955	58	31	110-72402	10	34
TA-0800504-R0	2	9	101-12803	16	31	101-49052	46	135	110-72402	12	6
TA-0950806-R0	2	58	101-12803	16	48	101-49052	48	48	110-72402	14	34
TA-1030402-R0	2	71	101-12803	16	60	101-49052	54	50	113-05901	26	27
TA-1050504-R0	2	72	101-12902	16	12	101-49052	58	32	119-57008	10	22

NUMERICAL INDEX OF PARTS

索引

PART NO 品番	PAGE 頁	REF NO	PART NO 品番	PAGE 頁	REF NO	PART NO 品番	PAGE 頁	REF NO	PART NO 品番	PAGE 頁	REF NO
119-57008	14	22	226-17708	14	11	226-30404	50	124	226-41450	44	26
122-10803	34	101	226-17807	10	13	226-30503	46	29	226-41450	48	123
131-38201	12	35	226-17807	14	13	226-30503	50	125	226-41450	50	181
131-70105	37	15	226-17906	10	18	226-30602	46	30	226-41450	52	61
131-71004	37	16	226-17906	14	18	226-30602	50	126	226-41658	44	27
133-19405	22	73	226-18201	10	15	226-30800	46	31	226-41658	48	124
			226-18201	14	15	226-30800	50	127	226-41658	50	182
225-29473	12	9	226-18300	10	16	226-30909	46	32	226-41658	52	62
226-00555	2	37	226-18300	14	16	226-30909	50	128	226-41757	44	28
226-00555	44	75	226-18706	10	4	226-31006	46	33	226-41757	48	125
226-00555	50	120	226-18706	14	4	226-31006	50	129	226-41757	50	183
226-00555	54	86	226-18805	10	8	226-31105	46	34	226-41757	52	63
226-00555	56	52	226-18805	14	8	226-31303	46	35	226-41856	44	29
226-00654	44	76	226-18904	10	25	226-31303	50	130	226-41856	48	126
226-00654	50	121	226-18904	10	26	226-31402	46	36	226-41955	44	30
226-00654	54	87	226-18904	14	25	226-31402	50	131	226-41955	48	127
226-00654	56	53	226-18904	14	26	226-31501	46	37	226-42052	44	31
226-00753	44	77	226-19100	2	8	226-31501	50	132	226-42052	48	160
226-00753	50	122	226-22401	4	10	226-31709	46	38	226-42151	44	32
226-00753	54	88	226-25008	46	139	226-31709	50	133	226-42151	48	161
226-00753	56	54	226-25107	46	140	226-31808	46	39	226-47051	44	63
226-00852	44	78	226-25107	50	101	226-31808	50	134	226-47150	44	64
226-00852	54	89	226-25206	46	141	226-31907	46	40	226-47259	44	66
226-01058	2	33	226-25206	50	102	226-32004	46	41	226-47358	44	67
226-01058	44	71	226-25305	46	142	226-32103	46	42	226-47457	44	69
226-01058	50	117	226-25305	50	104	226-32202	46	43	226-47556	44	70
226-01058	54	82	226-25404	46	144	226-37557	44	1	226-53802	16	84
226-01058	56	49	226-25404	50	106	226-37656	44	2	226-53802	42	23
226-01157	44	72	226-25503	2	35	226-37755	44	3	226-56003	22	86
226-01157	50	118	226-25503	46	145	226-37854	44	4	226-57209	30	5
226-01157	54	83	226-25503	50	107	226-38050	44	5	226-57308	30	8
226-01157	56	50	226-25602	46	147	226-38258	44	6	226-81209	8	2
226-01256	44	73	226-25602	50	109	226-38357	44	7	226-81407	8	24
226-01256	50	119	226-25701	46	148	226-38456	44	8	226-81506	8	25
226-01256	54	84	226-25701	50	110	226-38753	44	9	226-81712	8	8
226-01256	56	51	226-25800	46	149	226-38951	44	10	226-81803	8	15
226-01355	44	74	226-25800	50	111	226-39157	44	11	226-81951	8	10
226-01355	54	85	226-25909	46	150	226-39256	44	12	226-82058	8	11
226-03708	2	44	226-26006	46	151	226-39355	44	13	226-82157	8	12
226-03708	34	73	226-26006	50	112	226-39454	44	14	226-82256	8	13
226-05307	4	2	226-26105	46	152	226-40353	44	17	226-82355	8	14
226-06206	6	5	226-26105	50	113	226-40353	48	114	226-82504	8	83
226-06206	8	47	226-26204	46	153	226-40353	50	173	226-82702	8	7
226-06305	6	6	226-26204	50	114	226-40353	52	53	226-83304	8	57
226-06305	8	48	226-26303	46	154	226-40452	44	18	226-83403	8	61
226-06404	6	12	226-26303	50	115	226-40452	48	115	226-83601	8	69
226-06404	8	54	226-26402	46	155	226-40452	50	174	226-83809	8	59
226-06800	6	2	226-26402	50	116	226-40452	52	54	226-83908	8	65
226-07600	6	7	226-26501	46	156	226-40551	24	42	226-84005	8	66
226-07600	8	49	226-26600	46	157	226-40551	44	19	226-84104	8	62
226-07709	6	8	226-26709	46	158	226-40551	48	116	226-84203	8	64
226-07709	8	50	226-26808	46	159	226-40551	50	175	226-85200	8	31
226-07808	6	10	226-27152	44	57	226-40551	52	55	226-85200	8	40
226-07808	8	52	226-27350	44	58	226-40759	44	20	226-85408	8	32
226-07907	6	11	226-27459	44	59	226-40759	48	117	226-85408	8	41
226-07907	8	53	226-27558	44	60	226-40759	50	176	226-85705	8	77
226-12105	16	30	226-27657	44	61	226-40759	52	56	226-85804	8	21
226-12105	16	62	226-27756	44	62	226-40858	44	21	226-85903	8	17
226-12204	16	67	226-28002	46	160	226-40858	48	118	226-86000	8	20
226-12303	16	10	226-28002	54	73	226-40858	50	177	226-86109	8	23
226-12303	16	27	226-28101	46	161	226-40858	52	57	226-87008	14	61
226-12303	16	53	226-28101	54	74	226-40957	44	22	226-87107	14	59
226-12303	16	58	226-28200	46	162	226-40957	48	119	226-87503	14	54
226-12402	16	23	226-28200	54	75	226-40957	50	178	226-87602	14	57
226-12402	16	63	226-28309	46	163	226-40957	52	58	226-87701	14	55
226-12709	16	15	226-28309	54	76	226-41054	44	23	226-88105	16	4
226-12907	16	14	226-28408	46	164	226-41054	48	120	226-88105	16	42
226-12907	16	46	226-28408	54	77	226-41252	44	24	226-88154	16	41
226-14002	16	35	226-28507	46	165	226-41252	48	121	226-88204	16	6
226-14101	16	36	226-28507	54	78	226-41252	50	179	226-88204	16	44
226-14200	16	37	226-28606	46	166	226-41252	52	59	226-88402	16	5
226-15702	14	64	226-28606	54	79	226-41351	44	25	226-88402	16	43
226-17609	10	10	226-30206	46	27	226-41351	48	122	228-10907	4	8
226-17609	14	10	226-30206	50	123	226-41351	50	180	228-13000	18	9
226-17708	10	11	226-30404	46	28	226-41351	52	60	228-13109	18	8

NUMERICAL INDEX OF PARTS

索引

PART NO 品番	PAGE 頁	REF NO	PART NO 品番	PAGE 頁	REF NO	PART NO 品番	PAGE 頁	REF NO	PART NO 品番	PAGE 頁	REF NO
228-16557	44	34	229-21209	12	12	236-28902	34	53	400-12085	16	68
228-16557	48	129	229-21308	36	40	236-29306	32	45	400-12404	26	58
228-16557	50	185	229-21407	12	14	236-29306	34	45	400-12487	26	46
228-16557	52	65	229-21407	36	41	236-29405	32	7	400-12488	26	45
228-16557	54	55	229-21506	12	15	236-29405	32	34	400-12489	26	55
228-16557	56	83	229-21506	36	42	236-29405	34	7	400-12492	26	39
228-16557	58	66	229-21605	12	16	236-29405	34	34	400-12495	26	50
228-16557	60	40	229-21704	36	43	236-29405	34	100	400-12496	26	56
228-16656	44	35	229-21803	12	18	236-29504	32	64	400-12497	26	78
228-16656	48	130	229-24708	32	41	236-29504	34	64	400-12500	26	71
228-16656	50	186	229-24708	34	41	236-30007	32	31	400-12503	26	77
228-16656	52	66	229-26000	42	25	236-30007	32	50	400-12504	26	29
228-16656	54	56	229-26208	42	27	236-30007	32	52	400-12505	26	19
228-16656	56	84	229-26356	42	29	236-30007	32	66	400-12505	26	30
228-16656	58	67	229-26505	42	28	236-30007	32	67	400-12506	26	20
228-16656	60	41	229-31604	42	2	236-30007	34	31	400-13061	20	6
228-16755	44	36	229-32107	37	4	236-30007	34	46	400-13316	26	60
228-16755	48	131	229-32206	37	8	236-30007	34	47	400-13362	22	64
228-16755	50	187	229-32404	37	11	236-30007	34	50	400-13509	32	81
228-16755	52	67	229-32453	37	10	236-30007	34	52	400-13509	34	81
228-16755	54	57	229-32800	42	5	236-30007	34	66	400-14844	26	35
228-16755	56	85	229-33105	42	6	236-30007	34	67	400-15144	8	71
228-16755	58	68	229-33204	42	7	236-30106	32	4	400-15669	26	24
228-16755	60	42	229-33303	42	34	236-30106	32	5	400-15699	12	28
228-16854	44	37	229-33600	36	11	236-30106	32	16	400-17361	26	13
228-16854	48	132	229-33659	36	9	236-30106	32	35	400-17362	26	25
228-16854	50	188	229-33758	36	10	236-30106	32	38	400-17399	26	8
228-16854	52	68	229-34202	37	21	236-30106	34	4	400-17400	26	12
228-16854	54	58	229-34251	37	17	236-30106	34	5	400-17401	26	15
228-16854	56	86	229-34301	37	22	236-30106	34	16	400-17402	26	16
228-16854	58	69	229-34400	37	23	236-30106	34	35	400-17403	26	23
228-16854	60	43	229-34509	37	18	236-30106	34	38	400-20454	4	26
228-16953	44	38	229-34608	37	19	236-30106	34	98	400-20455	4	27
228-16953	48	133	229-34707	37	12	236-30403	32	77	400-21726	26	69
228-16953	50	189	229-44508	24	51	236-30403	34	77	400-21883	26	40
228-16953	52	69	229-45307	12	11	236-30502	32	76	400-21898	26	43
228-16953	54	59	229-45505	12	7	236-30502	34	76	400-21899	26	42
228-16953	56	87	229-48558	26	10	236-30601	32	33	400-22589	20	26
228-16953	58	70	229-52501	22	84	236-30601	34	33	400-22590	20	27
228-16953	60	44	229-55504	30	2	236-30601	34	99	400-22678	4	6
228-17050	44	39	229-55900	30	10	236-30650	32	36	400-23568	6	32
228-17050	48	134	229-56007	30	11	236-30650	34	36	400-23568	8	73
228-17050	50	190	229-56205	30	7	236-31708	28	3	400-24064	8	67
228-17050	52	70	229-57104	30	13	236-31807	28	4	400-24093	4	4
228-17050	54	60	229-57203	30	19	236-31906	28	5	400-24436	4	18
228-17050	56	88	229-58003	42	26	236-32102	28	8	400-24473	8	58
228-17050	58	71	229-58052	42	24	236-38109	28	39	400-25191	37	7
228-17050	60	45	229-91400	38	8	236-38208	28	41	400-25235	2	38
228-17159	44	41	232-03300	12	44	236-38307	28	40	400-25235	48	149
228-17159	48	136	232-04506	6	13	236-38406	28	42	400-25235	52	194
228-17159	50	191	232-04506	8	44	262-30409	32	69	400-25235	58	86
228-17159	52	71	232-04605	6	14	262-30409	34	69	400-25235	60	102
228-17159	54	62	232-04605	8	45	262-61503	36	28	400-25236	48	150
228-17159	56	89	232-04704	6	15				400-25236	52	195
228-17159	58	73	232-04704	8	46	400-04171	4	16	400-25236	58	87
228-17159	60	46	232-04803	32	48	400-04749	32	28	400-25236	60	103
228-19809	18	21	232-04803	32	84	400-04749	34	28	400-25239	48	151
228-19809	42	40	232-04803	34	105	400-06323	42	9	400-25239	52	196
228-27257	18	39	232-04803	34	109	400-09196	30	6	400-25239	58	88
228-44450	44	55	232-05107	46	95	400-09222	12	26	400-25239	60	104
228-44559	44	56	232-05305	46	96	400-10417	4	40	400-25240	48	152
228-45200	46	167	232-05503	46	97	400-10417	4	44	400-25240	58	89
228-45408	46	168	232-06709	2	75	400-10434	26	9	400-25247	2	34
228-45606	46	169	232-06709	44	84	400-10470	4	9	400-25247	48	145
228-88507	20	43	235-42418	26	6	400-11906	22	32	400-25247	52	191
228-91204	36	32	236-01057	2	5	400-11926	22	68	400-25247	58	82
229-01805	2	29	236-09001	24	41	400-11932	22	37	400-25247	60	99
229-07406	24	28	236-09209	24	33	400-11934	22	36	400-25248	48	146
229-07604	24	34	236-09605	24	6	400-11935	22	7	400-25248	52	192
229-07703	24	35	236-18804	20	7	400-11939	22	43	400-25248	58	83
229-07802	24	1	236-26005	12	13	400-11946	22	35	400-25248	60	100
229-08008	24	9	236-26005	12	31	400-11947	20	44	400-25249	48	147
229-11804	22	15	236-28803	32	100	400-12085	16	9	400-25249	52	193
229-12109	22	42	236-28803	34	49	400-12085	16	25	400-25249	58	84
229-20706	2	42	236-28902	32	53	400-12085	16	51	400-25249	60	101

NUMERICAL INDEX OF PARTS

索引

PART NO 品番	PAGE 頁	REF NO	PART NO 品番	PAGE 頁	REF NO	PART NO 品番	PAGE 頁	REF NO	PART NO 品番	PAGE 頁	REF NO
400-25250	48	148	400-25794	50	145	400-25823	48	75	400-26037	48	25
400-25250	58	85	400-25795	46	55	400-25824	48	76	400-26039	46	113
400-25315	22	8	400-25795	50	146	400-25825	52	22	400-26041	48	158
400-25316	22	65	400-25796	46	56	400-25825	48	77	400-26041	46	114
400-25485	48	2	400-25796	50	147	400-25826	52	23	400-26041	48	26
400-25485	52	79	400-25797	46	57	400-25826	48	78	400-26043	46	115
400-25485	58	2	400-25798	46	58	400-25827	52	24	400-26043	48	27
400-25485	60	26	400-25799	46	59	400-25827	48	79	400-26045	46	116
400-25490	48	3	400-25800	46	60	400-25827	52	25	400-26045	48	28
400-25490	52	80	400-25801	46	79	400-25828	48	80	400-26047	46	117
400-25491	48	5	400-25801	50	160	400-25828	52	26	400-26047	48	29
400-25491	52	82	400-25801	54	19	400-25829	48	81	400-26049	46	118
400-25491	58	4	400-25801	56	71	400-25830	48	82	400-26049	48	30
400-25491	60	28	400-25802	46	80	400-25831	48	98	400-26051	46	119
400-25492	2	36	400-25802	50	161	400-25831	52	40	400-26051	48	31
400-25492	48	6	400-25802	54	20	400-25831	58	51	400-26053	46	120
400-25492	52	83	400-25802	56	72	400-25831	60	14	400-26053	48	159
400-25493	48	8	400-25803	46	81	400-25832	48	99	400-26055	46	121
400-25493	52	85	400-25803	50	162	400-25832	52	41	400-26055	48	32
400-25493	58	6	400-25803	54	21	400-25832	58	52	400-26057	46	122
400-25493	60	30	400-25803	56	73	400-25832	60	15	400-26057	48	33
400-25494	48	9	400-25804	46	82	400-25833	48	100	400-26059	46	123
400-25494	52	86	400-25804	50	163	400-25833	52	42	400-26059	48	34
400-25494	58	7	400-25804	54	22	400-25833	58	53	400-26061	46	124
400-25494	60	31	400-25804	56	74	400-25833	60	16	400-26061	48	35
400-25495	48	10	400-25805	46	83	400-25834	48	101	400-26063	50	56
400-25495	52	87	400-25805	50	164	400-25834	52	43	400-26063	52	146
400-25495	58	8	400-25805	54	23	400-25834	58	54	400-26065	50	57
400-25495	60	32	400-25805	56	75	400-25834	60	17	400-26065	52	147
400-25496	48	11	400-25806	46	84	400-25835	48	102	400-26067	50	58
400-25496	58	9	400-25806	50	165	400-25835	52	44	400-26067	52	148
400-25498	48	12	400-25806	54	24	400-25835	58	55	400-26069	50	59
400-25498	52	88	400-25806	56	76	400-25835	60	18	400-26069	52	149
400-25498	58	10	400-25807	46	85	400-25836	48	103	400-26070	50	60
400-25498	60	33	400-25807	54	25	400-25836	52	45	400-26070	52	150
400-25499	48	13	400-25808	46	86	400-25836	58	56	400-26072	50	61
400-25499	52	89	400-25808	50	166	400-25836	60	19	400-26072	52	151
400-25499	58	11	400-25808	54	26	400-25837	48	104	400-26074	50	62
400-25499	60	34	400-25808	56	77	400-25837	58	57	400-26074	52	152
400-25500	48	14	400-25809	46	87	400-25838	48	105	400-26076	50	63
400-25500	52	90	400-25809	50	167	400-25838	52	46	400-26076	52	153
400-25500	58	12	400-25809	54	27	400-25838	58	58	400-26078	50	64
400-25500	60	35	400-25809	56	78	400-25838	60	20	400-26078	52	154
400-25502	48	15	400-25810	46	88	400-25839	48	106	400-26080	50	65
400-25502	52	91	400-25810	50	168	400-25839	52	47	400-26080	52	155
400-25502	58	13	400-25810	54	28	400-25839	58	59	400-26082	50	66
400-25502	60	36	400-25810	56	79	400-25839	60	21	400-26082	52	156
400-25503	48	16	400-25811	46	89	400-25840	48	107	400-26084	50	68
400-25503	52	92	400-25811	50	169	400-25840	52	48	400-26084	52	158
400-25503	58	14	400-25811	54	29	400-25840	58	60	400-26086	50	69
400-25503	60	37	400-25811	56	80	400-25840	60	22	400-26086	52	159
400-25504	48	17	400-25812	46	90	400-25841	48	108	400-26088	50	70
400-25504	58	15	400-25812	50	170	400-25841	52	49	400-26088	52	160
400-25505	48	18	400-25812	54	30	400-25841	58	61	400-26090	50	71
400-25505	58	16	400-25812	56	81	400-25841	60	23	400-26090	52	161
400-25784	46	44	400-25813	46	91	400-25842	48	109	400-26091	50	72
400-25784	50	136	400-25813	54	31	400-25842	52	50	400-26091	52	162
400-25785	46	45	400-25814	46	92	400-25842	58	62	400-26093	50	73
400-25785	50	137	400-25814	54	32	400-25842	60	24	400-26093	52	163
400-25786	46	46	400-25815	46	93	400-25843	48	110	400-26095	50	74
400-25786	50	138	400-25815	54	33	400-25843	58	63	400-26095	52	164
400-25787	46	47	400-25816	46	94	400-25844	48	111	400-26097	50	75
400-25787	50	139	400-25816	54	34	400-25844	58	64	400-26097	52	165
400-25788	46	48	400-25817	48	68	400-26027	46	107	400-26099	50	76
400-25788	50	140	400-25817	52	15	400-26027	48	20	400-26099	52	166
400-25789	46	49	400-25818	48	69	400-26029	46	108	400-26101	50	77
400-25789	50	141	400-25818	52	16	400-26029	48	21	400-26101	52	167
400-25790	46	50	400-25819	48	70	400-26031	46	109	400-26103	50	78
400-25790	50	142	400-25819	52	17	400-26031	48	22	400-26103	52	168
400-25791	46	51	400-25820	48	72	400-26033	46	110	400-26402	8	3
400-25792	46	52	400-25820	52	19	400-26033	48	23	400-26673	22	12
400-25792	50	143	400-25821	48	73	400-26035	6	16	400-26715	48	71
400-25793	46	53	400-25821	52	20	400-26035	46	111	400-26715	52	18
400-25793	50	144	400-25822	48	74	400-26035	48	24	400-26811	2	60
400-25794	46	54	400-25822	52	21	400-26037	46	112	400-26909	26	70

NUMERICAL INDEX OF PARTS

索引

PART NO 品番	PAGE 頁	REF NO	PART NO 品番	PAGE 頁	REF NO	PART NO 品番	PAGE 頁	REF NO	PART NO 品番	PAGE 頁	REF NO
400-26920	4	31	400-31351	20	4	400-33949	58	76	400-35877	50	55
400-26981	8	39	400-31352	26	33	400-33949	60	49	400-35877	52	145
400-26982	8	30	400-31862	6	34	400-33951	44	45	400-35878	50	67
400-26983	8	29	400-31864	4	13	400-33951	48	140	400-35878	52	157
400-26984	8	38	400-32107	37	1	400-33951	50	195	400-35881	48	1
400-28116	4	36	400-32124	6	26	400-33951	52	75	400-35881	52	78
400-28117	4	19	400-32124	8	79	400-33951	54	66	400-35881	58	1
400-28200	8	82	400-32142	4	34	400-33951	56	93	400-35881	60	25
400-28245	2	13	400-32147	8	55	400-33951	58	77	400-35883	46	15
400-28250	12	4	400-32268	22	45	400-33951	60	50	400-35884	46	16
400-28268	24	17	400-32269	22	10	400-33953	44	46	400-35885	46	17
400-28269	24	40	400-32272	24	38	400-33953	48	141	400-35886	46	18
400-28271	20	1	400-32293	22	22	400-33953	54	67	400-35887	46	19
400-28274	22	57	400-32327	14	50	400-33953	58	78	400-35888	46	20
400-28276	22	59	400-32405	32	55	400-33955	44	47	400-35890	48	67
400-28276	22	94	400-32406	32	56	400-33955	48	142	400-35890	52	14
400-28277	22	49	400-32707	12	1	400-33955	54	68	400-35891	48	84
400-28279	22	39	400-32709	12	2	400-33955	58	79	400-35891	52	28
400-28280	22	63	400-32804	32	44	400-33957	44	48	400-35891	58	37
400-28284	22	3	400-32804	34	44	400-33957	48	162	400-35891	60	2
400-28286	22	9	400-32896	2	43	400-33957	54	69	400-35892	48	86
400-28287	22	70	400-32987	4	21	400-33959	44	49	400-35892	52	30
400-28291	22	66	400-33160	26	51	400-33959	48	163	400-35892	58	39
400-28293	22	2	400-33337	26	38	400-33959	54	70	400-35892	60	4
400-28294	22	67	400-33434	24	24	400-34267	36	8	400-35893	48	89
400-28485	20	8	400-33435	24	25	400-34660	12	43	400-35893	52	33
400-28486	20	12	400-33563	46	21	400-34675	2	61	400-35893	58	42
400-28487	20	9	400-33564	46	22	400-34840	12	24	400-35893	60	7
400-28488	20	13	400-33565	46	23	400-34853	37	3	400-35894	48	90
400-28495	20	32	400-33566	46	24	400-34969	20	10	400-35894	52	34
400-28496	20	33	400-33567	46	25	400-34970	20	14	400-35894	58	43
400-28545	24	12	400-33568	46	26	400-34971	20	11	400-35894	60	8
400-28546	24	20	400-33668	22	80	400-34972	20	15	400-35895	48	92
400-28547	24	37	400-33669	6	23	400-35151	24	11	400-35895	52	36
400-28641	14	63	400-33669	8	75	400-35180	2	51	400-35895	58	45
400-28652	4	41	400-33714	46	1	400-35181	24	16	400-35895	60	10
400-28666	6	20	400-33715	46	2	400-35264	32	87	400-35896	44	15
400-28679	8	60	400-33716	46	3	400-35264	34	87	400-35896	48	112
400-28706	2	45	400-33718	46	4	400-35277	28	33	400-35896	50	171
400-28730	2	27	400-33720	46	5	400-35278	28	32	400-35896	52	51
400-28731	2	46	400-33722	46	6	400-35298	24	21	400-35896	60	38
400-28766	2	2	400-33723	46	7	400-35394	24	4	400-35897	44	16
400-28778	37	2	400-33724	46	8	400-35704	22	50	400-35897	48	113
400-28797	30	24	400-33727	46	9	400-35761	50	1	400-35897	50	172
400-28799	30	25	400-33729	46	10	400-35761	52	93	400-35897	52	52
400-28843	14	69	400-33731	46	11	400-35762	50	2	400-36167	32	39
400-28844	14	71	400-33732	46	12	400-35762	52	94	400-36167	34	39
400-28852	22	51	400-33733	46	13	400-35765	50	6	400-36221	38	2
400-28853	6	27	400-33734	46	14	400-35765	52	98	400-36222	38	3
400-28853	8	80	400-33941	44	40	400-35766	50	7	400-36223	38	9
400-28854	22	5	400-33941	48	135	400-35766	52	99	400-36333	32	61
400-28855	22	72	400-33941	54	61	400-35768	50	9	400-36333	34	61
400-29048	4	35	400-33941	58	72	400-35768	52	100	400-36360	28	18
400-29075	32	17	400-33945	44	42	400-35769	50	10	400-36428	42	32
400-29075	34	17	400-33945	48	137	400-35769	52	101	400-36433	22	18
400-29078	2	54	400-33945	50	192	400-35770	50	11	400-36446	26	36
400-29347	2	22	400-33945	52	72	400-35770	52	102	400-36679	22	56
400-29561	8	35	400-33945	54	63	400-35771	50	14	400-36682	16	57
400-29562	8	42	400-33945	56	90	400-35771	52	105	400-36683	16	56
400-29570	20	18	400-33945	58	74	400-35772	50	15	400-36685	16	40
400-29641	2	17	400-33945	60	47	400-35772	52	106	400-36686	16	29
400-29964	4	11	400-33947	44	43	400-35775	50	19	400-36686	16	71
400-29972	2	18	400-33947	48	138	400-35775	52	110	400-36687	16	11
400-30027	8	88	400-33947	50	193	400-35776	50	20	400-36687	16	55
400-30037	6	30	400-33947	52	73	400-35776	52	111	400-36687	16	70
400-30038	6	38	400-33947	54	64	400-35778	50	22	400-36688	16	61
400-30298	2	14	400-33947	56	91	400-35778	52	112	400-36689	16	8
400-30299	2	15	400-33947	58	75	400-35779	50	23	400-36689	16	24
400-30768	42	31	400-33947	60	48	400-35779	52	113	400-36689	16	50
400-30856	28	27	400-33949	44	44	400-35780	50	24	400-36689	16	66
400-30954	38	17	400-33949	48	139	400-35780	52	114	400-37008	36	45
400-30962	38	4	400-33949	50	194	400-35828	24	22	400-39391	16	49
400-31348	22	26	400-33949	52	74	400-35873	42	33	400-39625	32	85
400-31349	22	40	400-33949	54	65	400-35875	46	106	400-39625	34	108
400-31350	22	75	400-33949	56	92	400-35875	48	19	400-39629	8	9

NUMERICAL INDEX OF PARTS

索引

PART NO 品番	PAGE 頁	REF NO	PART NO 品番	PAGE 頁	REF NO	PART NO 品番	PAGE 頁	REF NO	PART NO 品番	PAGE 頁	REF NO
400-39824	30	28	400-51633	56	55	400-71911	48	83	400-91193	14	46
400-40302	6	37	400-51633	58	90	400-71911	52	27	400-91194	12	48
400-40809	32	75	400-51633	60	105	400-71911	58	36	400-91195	32	19
400-40809	34	75	400-52366	12	5	400-71911	60	1	400-91195	34	19
400-40924	22	87	400-53231	24	19	400-71912	48	91	400-91196	32	26
400-40963	22	88	400-53371	18	29	400-71912	52	35	400-91196	34	26
400-41578	32	82	400-53705	48	97	400-71912	58	44	400-91198	32	89
400-41578	34	82	400-53705	52	39	400-71912	60	9	400-91198	34	89
400-41579	32	83	400-53705	58	50	400-71913	48	93	400-91199	32	90
400-41579	34	83	400-53705	60	13	400-71913	52	37	400-91199	34	90
400-42121	16	1	400-55358	18	20	400-71913	58	46	400-91200	32	15
400-42141	20	16	400-55358	42	39	400-71913	60	11	400-91200	34	15
400-42151	30	17	400-55883	38	1	400-71914	48	94	400-91202	32	14
400-42874	2	40	400-56385	38	21	400-71914	52	38	400-91202	34	14
400-42874	44	83	400-56438	38	22	400-71914	58	47	400-91203	32	24
400-42874	50	54	400-56698	12	10	400-71914	60	12	400-91203	34	24
400-42874	54	94	400-56705	42	4	400-71915	48	95	400-91204	32	30
400-42874	56	58	400-57361	18	11	400-71915	58	48	400-91204	34	30
400-42880	2	39	400-57398	24	5	400-71916	48	96	400-91205	32	22
400-42880	48	157	400-59036	8	56	400-71916	58	49	400-91205	34	22
400-42880	52	144	400-59504	38	16	400-71917	50	12	400-91206	14	72
400-42880	58	94	400-59505	38	19	400-71917	52	103	400-91208	28	1
400-42880	60	108	400-59786	18	40	400-71919	50	25	400-91209	28	2
400-43322	4	46	400-59787	18	41	400-71919	52	115	400-91210	28	37
400-43333	18	34	400-60689	12	29	400-71921	50	13	400-91211	28	17
400-43334	18	35	400-60693	12	41	400-71921	52	104	400-91212	36	38
400-43335	18	37	400-60840	12	42	400-71923	50	26	400-91227	4	29
400-43336	18	38	400-61270	48	52	400-71923	52	116	400-91238	32	29
400-43921	20	46	400-61270	52	1	400-72338	50	103	400-91238	34	29
400-43922	20	48	400-61271	48	53	400-72896	26	68	400-91241	36	39
400-43923	20	47	400-61271	52	2	400-75311	46	69	400-91246	28	38
400-43924	20	49	400-61272	48	54	400-75311	54	9	400-91256	28	7
400-44393	26	52	400-61272	52	3	400-76708	26	76	400-91257	28	6
400-45729	44	80	400-61273	48	55	400-76709	26	64	400-91258	10	33
400-45729	48	154	400-61273	52	4	400-79641	16	86	400-91259	10	23
400-45729	50	52	400-61274	48	56	400-80006	12	30	400-91259	14	23
400-45729	52	142	400-61274	52	5	400-83824	10	38	400-91265	14	33
400-45729	54	91	400-61275	48	57	400-83824	14	38	400-91266	14	41
400-45729	56	56	400-61275	52	6	400-84142	2	24	400-91267	14	45
400-45729	58	91	400-61276	48	58	400-84419	24	32	400-91282	42	1
400-45729	60	106	400-61276	52	7	400-84941	24	23	400-91286	28	46
400-45730	44	81	400-61277	48	59	400-85717	24	49	400-92944	42	14
400-45730	48	155	400-61277	52	8	400-85773	24	48	400-93056	42	15
400-45730	50	53	400-61278	48	60	400-85784	40	13	400-93057	42	17
400-45730	52	143	400-61278	52	9	400-85785	40	7	400-93523	28	9
400-45730	54	92	400-61279	48	61	400-85788	40	17	400-94315	22	90
400-45730	56	57	400-61279	52	10	400-85789	40	16	400-94316	22	91
400-45730	58	92	400-61280	48	62	400-85790	40	15	400-94318	22	61
400-45730	60	107	400-61280	52	11	400-85791	40	14	400-94770	10	2
400-45731	44	82	400-61281	48	63	400-85792	40	8	400-94771	14	2
400-45731	48	156	400-61281	52	12	400-85793	40	6	400-94772	2	63
400-45731	54	93	400-61282	48	64	400-85794	40	3	400-94772	46	146
400-45731	58	93	400-61282	52	13	400-85795	40	4	400-94772	50	108
400-49219	12	40	400-61283	48	65	400-85796	40	21	400-94772	54	81
400-50003	18	1	400-61284	48	66	400-86678	30	14	400-94772	56	48
400-50009	48	85	400-62249	46	102	400-86679	30	15	400-94773	2	74
400-50009	52	29	400-62251	46	103	400-89557	36	1	400-94773	48	7
400-50009	58	38	400-62252	46	104	400-89558	36	2	400-94773	52	84
400-50009	60	3	400-62253	46	105	400-91143	16	22	400-94773	58	5
400-50010	48	87	400-62254	46	98	400-91144	16	3	400-94773	60	29
400-50010	52	31	400-62256	46	99	400-91179	2	20	400-94774	46	171
400-50010	58	40	400-62257	46	100	400-91180	4	24	400-94774	50	198
400-50010	60	5	400-62258	46	101	400-91181	4	23	400-94774	54	96
400-50011	48	88	400-65721	26	2	400-91182	2	47	400-94774	56	97
400-50011	52	32	400-65722	26	67	400-91183	2	50	400-94776	44	68
400-50011	58	41	400-66128	26	1	400-91184	2	64	400-94776	48	144
400-50011	60	6	400-67594	22	58	400-91185	2	65	400-94776	50	135
400-50314	24	46	400-71909	44	33	400-91186	2	66	400-94776	52	77
400-50584	22	47	400-71909	48	128	400-91187	22	62	400-94776	54	72
400-51384	24	8	400-71909	50	184	400-91188	22	20	400-94776	56	95
400-51633	44	79	400-71909	52	64	400-91189	22	53	400-94776	58	81
400-51633	48	153	400-71909	54	54	400-91190	22	30	400-94776	60	52
400-51633	50	51	400-71909	56	82	400-91191	10	1	400-95142	22	81
400-51633	52	141	400-71909	58	65	400-91192	14	1	400-95222	8	26
400-51633	54	90	400-71909	60	39	400-91193	10	41	400-95288	46	143

NUMERICAL INDEX OF PARTS

索引

PART NO 品番	PAGE 頁	REF NO	PART NO 品番	PAGE 頁	REF NO	PART NO 品番	PAGE 頁	REF NO	PART NO 品番	PAGE 頁	REF NO
400-95288	50	105	401-51856	16	76						
400-95288	54	80	401-51857	16	77						
400-95288	56	47	401-51858	16	78						
400-95289	48	4	401-51866	20	36						
400-95289	52	81	401-53307	18	22						
400-95289	58	3	401-53308	18	23						
400-95289	60	27	401-53309	18	24						
400-95291	46	170	401-53310	18	25						
400-95291	50	197	401-53311	18	26						
400-95291	54	95	401-53312	18	27						
400-95291	56	96	401-53313	20	50						
400-95293	44	65	401-60015	32	13						
400-95293	48	143	401-60015	34	13						
400-95293	50	196	401-60332	32	37						
400-95293	52	76	401-60332	34	37						
400-95293	54	71	401-60401	32	32						
400-95293	56	94	401-60401	34	32						
400-95293	58	80	401-65109	32	93						
400-95293	60	51	401-65109	34	93						
400-96206	22	89	401-66315	8	6						
400-96325	40	22	401-66870	36	33						
400-96326	40	23	401-66872	36	26						
400-96327	40	20	401-66881	36	29						
400-96939	2	41	401-66885	36	19						
400-96975	30	1	401-66886	36	16						
400-97210	32	10	401-66887	36	30						
400-97210	32	59	401-66888	36	21						
400-97210	34	10	401-66894	36	17						
400-97210	34	59	401-91115	36	25						
400-97211	40	1	402-11878	30	12						
400-98038	4	48	402-21500	6	33						
400-98612	28	43	402-21500	8	74						
400-98762	26	72	402-29459	44	86						
400-98763	26	73	402-29459	48	168						
400-98764	26	74	402-29459	50	200						
400-98905	4	45	402-29459	52	198						
401-00131	28	28	402-29459	54	98						
401-00900	30	16	402-29459	56	99						
401-01423	38	15	402-29459	58	96						
401-02087	42	22	402-29459	60	110						
401-02831	24	50	402-29461	44	85						
401-04434	20	2	402-29461	48	167						
401-04435	20	3	402-29461	50	199						
401-04436	16	2	402-29461	52	197						
401-04436	18	2	402-29461	54	97						
401-06574	40	19	402-29461	56	98						
401-06575	40	2	402-29461	58	95						
401-06576	40	11	402-29461	60	109						
401-06579	40	12	402-35203	18	19						
401-06580	40	10	402-35203	42	37						
401-06583	40	9	402-36398	6	31						
401-08582	26	4	402-36399	6	1						
401-09091	22	71	402-55442	24	30						
401-09415	26	49	402-58716	16	87						
401-20727	42	35	402-81941	36	24						
401-20728	42	36	402-81942	36	23						
401-36258	2	77	402-81957	36	15						
401-42681	4	51	402-81959	36	22						
401-42685	4	39	402-81969	36	18						
401-43358	6	25	402-82051	36	20						
401-43358	8	78	402-82052	36	46						
401-43359	6	39	402-82075	36	14						
401-43359	8	89	402-98217	40	18						
401-43360	6	40	403-00491	32	47						
401-43360	8	90	403-00491	34	106						
401-43361	6	41	403-00891	32	46						
401-43361	8	91	403-00891	34	104						
401-50029	4	43									
401-50033	20	40									
401-50036	4	52									
401-51208	34	56									
401-51209	34	55									
401-51853	16	73									
401-51854	16	74									
401-51855	16	75									