

ENGLISH

**LBH-1790 / IP-310
INSTRUCTION MANUAL**

CONTENTS

1. NAME OF EACH SECTION OF THE OPERATION PANEL.....	4
1-1 Body.....	4
1-2 Buttons to be used in common.....	6
2. BASIC OPERATION OF THE SEWING MACHINE.....	7
3. LCD DISPLAY SECTION AT THE TIME OF INDEPENDENT SEWING	9
3-1 Data input screen	9
3-2 Sewing screen	12
4. HOW TO USE THE PEDAL	15
4-1 Setting procedure of the pedal type	15
4-2 Explanation of pedal motion	17
5. INPUTTING THE PRESSER TYPE	18
5-1 Setting procedure of the presser type.....	18
5-2 Table of presser type.....	19
6. PERFORMING PATTERN NO. SELECTION.....	20
6-1 Selection from the data input screen	20
6-2 Selection by means of DIRECT button.....	21
7. NAMING THE PATTERN	22
8. PERFORMING SEWING SHAPE SELECTION.....	23
9. CHANGING NEEDLE THREAD TENSION	25
10. PERFORMING RE-SEWING	27
10-1 To continue performing sewing from some point in sewing.....	28
10-2 To perform sewing from the start	28
11. WINDING BOBBIN THREAD.....	29
12. USING COUNTER	30
12-1 Setting procedure of the counter.....	30
12-2 Count-up releasing procedure	33
13. PERFORMING NEW REGISTRATION OF THE PATTERN	34
14. SEWING SHAPE LIST.....	36
15. CHANGING SEWING DATA.....	37
15-1 Initial sewing data at the time of your purchase	37
15-2 Changing procedure of sewing data	38
15-3 Sewing data list	40
16. SETTING PROCEDURE OF SEWING DATA WITH/WITHOUT EDIT.....	50
17. COPYING SEWING PATTERN.....	51
18. REGISTERING THE PATTERN TO DIRECT BUTTON.....	53
18-1 How to register	53
18-2 Register state at the time of your purchase.....	54
19. REGISTERING SEWING DATA TO CUSTOMIZE BUTTON.....	55
19-1 How to register	55

19-2 Register state at the time of your purchase.....	56
20. CHANGING SEWING MODE.....	57
21. LCD DISPLAY SECTION AT THE TIME OF CONTINUOUS STITCHING	58
21-1 Data input screen	58
21-2 Sewing screen	60
22. PERFORMING CONTINUOUS STITCHING.....	63
22-1 Selection of the continuous stitching data.....	63
22-2 Editing procedure of the continuous stitching data	64
23. LCD DISPLAY SECTION AT THE TIME OF CYCLE STITCHING	67
23-1 Data input screen	67
23-2 Sewing screen	69
24. PERFORMING CYCLE STITCHING.....	72
24-1 Selection of the cycle data	72
24-2 Editing procedure of the cycle data.....	73
25. PERFORMING CHANGE OF DISPLAY OF SEWING PRODUCT.....	75
26. CHANGING MEMORY SWITCH DATA	77
26-1 Changing procedure of memory switch data	77
26-2 Memory switch data list.....	79
27. EXPLANATION OF PLURAL MOTIONS OF KNIFE.....	86
28. ERROR CODE LIST	89
29. USING COMMUNICATION FUNCTION	98
29-1 Handling possible data	98
29-2 Performing communication by using the media	100
29-3 Performing communication by using RS-232C	103
29-4 Take-in of the data	104
30. INFORMATION FUNCTION.....	107
30-1 Observing the maintenance and inspection information	108
30-2 Inputting the inspection time	111
30-3 Releasing procedure of the warning	113
30-4 Observing the production control information.....	114
30-4-1 When displaying from the information screen.....	114
30-4-2 When displaying from the sewing screen	116
30-5 Performing setting of the production control information.....	117
30-6 Observing the working measurement information	121
31. TRIAL SEWING FUNCTION.....	125
31-1 Performing trial sewing.....	125
31-2 Vector parameter list.....	128
31-3 Thread tension value display color list	129
32. PERFORMING KEY LOCK.....	130
33. DISPLAYING VERSION INFORMATION.....	132
34. USING CHECK PROGRAM.....	133
34-1 Displaying the check program screen.....	133

34-2 Performing needle thread trimmer origin adjustment	135
34-3 Performing bobbin thread trimmer origin adjustment.....	136
34-4 Performing sensor check	137
34-5 Performing LCD check.....	139
34-6 Performing touch panel compensation.....	140
35. COMMUNICATION SCREEN OF MAINTENANCE PERSONNEL LEVEL.....	143
35-1 Data which are possible to be handled	143
35-2 Displaying maintenance personnel level	144
36. INFORMATION SCREEN OF THE MAINTENANCE PERSONNEL LEVEL.....	145
36-1 Display of error record.....	145
36-2 Display of the cumulative working information.....	147

1. NAME OF EACH SECTION OF THE OPERATION PANEL

1-1 Body



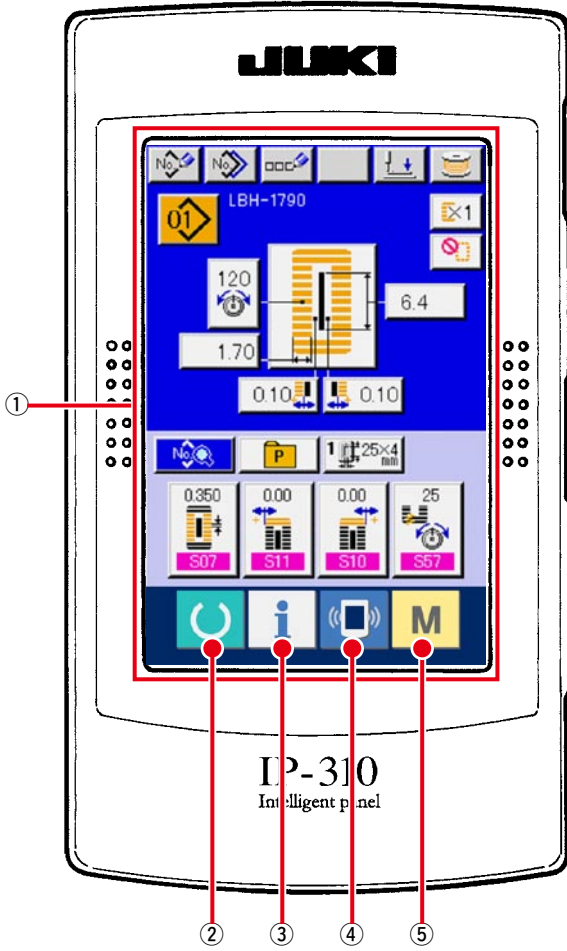

(Front)

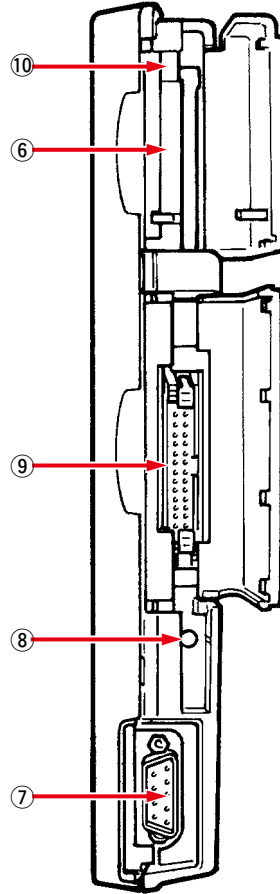

(Right side)











① Touch panel • LCD display section

- ②  READY key → Changeover of the data input screen and the sewing screen can be performed.
- ③  INFORMATION key → Changeover of the data input screen and the information screen can be performed.
- ④  COMMUNICATION key → Changeover of the data input screen and the communication screen can be performed.
- ⑤  MODE key → Changeover of the data input screen and the mode changeover screen which performs various detail settings can be performed.
- ⑥ MEDIA slot → MEDIA slot (use it with lid closed.)
- ⑦ CONNECTOR for RS-232C communication
- ⑧ VARIABLE RESISTOR for adjusting contrast of colored LCD screen → Contrast of the screen can be adjusted. Adjust it as you like.
- ⑨ CONNECTOR for external input
- ⑩ MEDIA take-out lever

1-2 Buttons to be used in common

The buttons which perform common operations in each screen of IP-310 are as follows :

	CANCEL button	→ This button closes the pop-up screen. In case of the data change screen, the data being changed can be cancelled.
	ENTER button	→ This button determines the changed data.
	UP SCROLL button	→ This button scrolls the button or the display in the upward direction.
	DOWN SCROLL button	→ This button scrolls the button or the display in the downward direction.
	RESET button	→ This button performs the release of error.
	NUMERAL INPUT button	→ This button displays ten keys and input of numerals can be performed.
	SEWING DATA DISPLAY button	→ This button displays the sewing data list corresponding to the pattern No. being selected. → Refer to 15. CHANGING SEWING DATA, p.37 .
	CHARACTER INPUT button	→ This button displays the character input screen. → Refer to 7. NAMING THE PATTERN, p.22 .
	PRESSER DOWN button	→ This button lowers the presser and displays the presser down screen. To raise the presser, press PRESSER UP button displayed in the presser down screen.
	BOBBIN WINDER button	→ This button performs bobbin thread winding. → Refer to 11. WINDING BOBBIN THREAD, p.29 .

2. BASIC OPERATION OF THE SEWING MACHINE

① Turn ON the power switch.

First, check that the presser type (A) which has been set is the same as that of the presser actually mounted. For checking and setting procedures, refer to [5. INPUTTING THE PRESSER TYPE, p.18.](#)

② Select the pattern No. you desire to sew.

When the power is turned ON, the data input screen is displayed. Pattern No. button (B) which is selected at present is displayed in the upper section of the screen. Press the button to select the pattern No. For selecting procedure of the pattern No., refer to [6. PERFORMING PATTERN NO. SELECTION, p.20.](#)

When you purchase the sewing machine, Pattern Nos. 1 to 10 described in [15-1. Initial sewing data at the time of your purchase have been registered, p.37.](#)

Select the pattern No. you desire to sew from among these numbers. (The No. to which the pattern has not been registered is not displayed.)

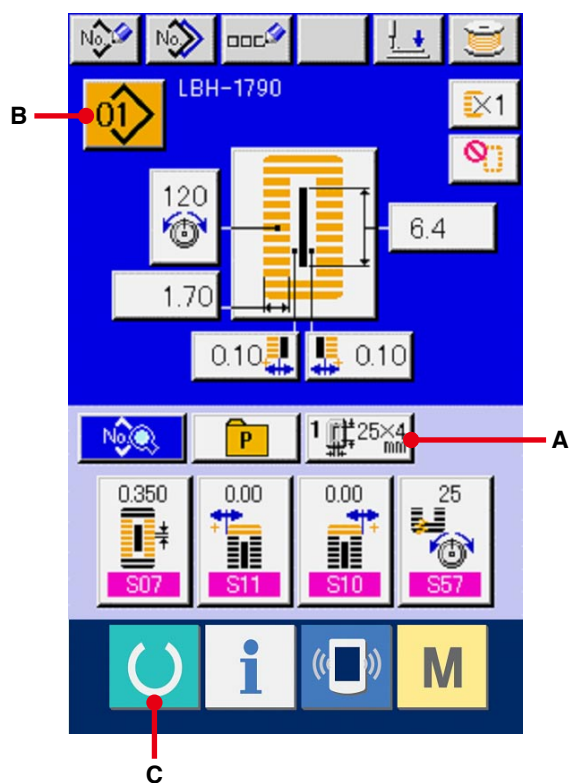

* For the detailed explanation of this screen, see [3. LCD DISPLAY SECTION AT THE TIME OF INDEPENDENT SEWING, p.9.](#)

③ **Set the sewing machine to sewing possible state.**

Press READY key  (C), and POWER OFF PROHIBITION screen is displayed. Make preparations for sewing while this screen is displayed. When the sewing is in a possible state, the back-light of LCD display changes to green color.

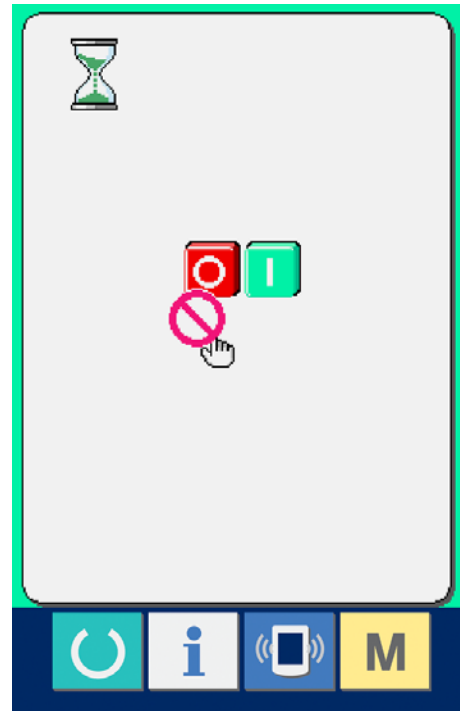

④ **Start sewing.**

Set the sewing product to the presser portion, operate the pedal to start the sewing machine, and sewing starts.

→ Refer to [4. HOW TO USE THE PEDAL, p.15.](#)

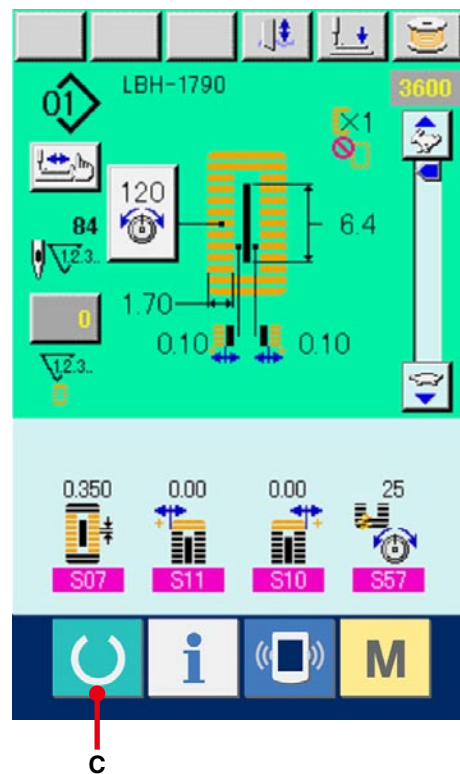

※ For the detailed explanation of this screen, refer to [3. LCD DISPLAY SECTION AT THE TIME OF INDEPENDENT SEWING, p.9.](#)

3. LCD DISPLAY SECTION AT THE TIME OF INDEPENDENT SEWING

3-1 Data input screen

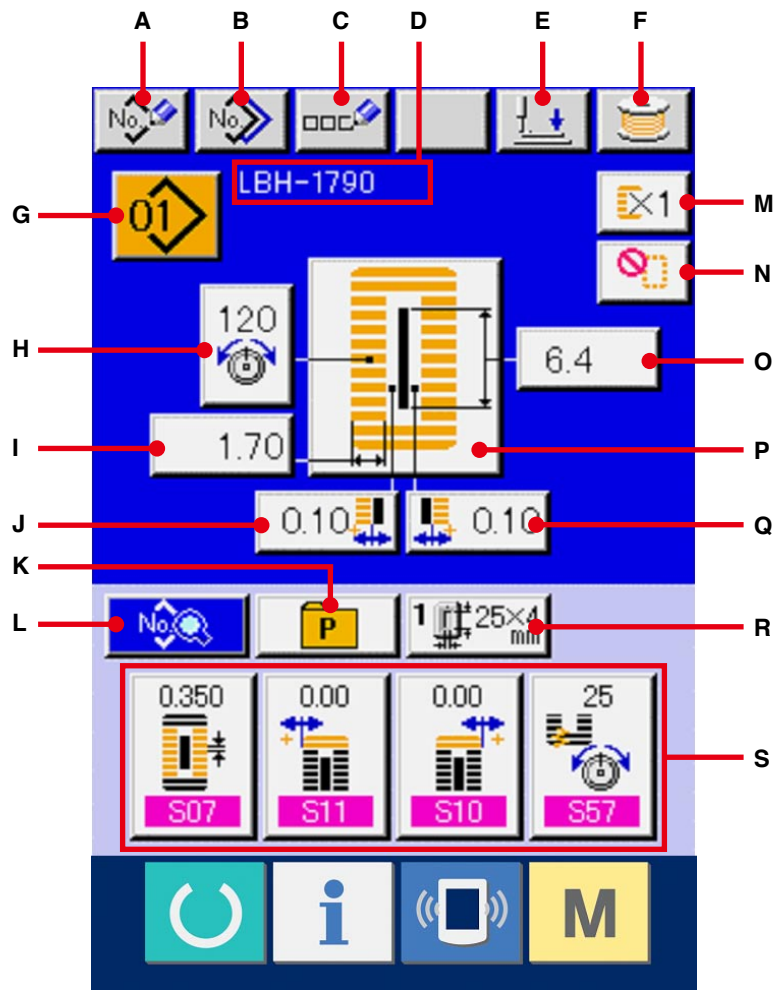

	Button and display	Description
A	PATTERN NEW REGISTER button	Pattern No. new register screen is displayed. → Refer to 13. PERFORMING NEW REGISTER OF SEWING PATTERN, p.34.
B	PATTERN COPY button	Sewing data copy screen is displayed. → Refer to 17. COPYING SEWING PATTERN, p.51.
C	PATTERN NAME SETTING button	Sewing pattern name input screen is displayed. → Refer to 7. NAMING THE PATTERN, p.22.
D	PATTERN NAME display	Name which has been inputted to the sewing pattern being selected is displayed.
E	PRESSER DOWN button	Presser down screen is displayed and the needle moves to the right side. To raise the presser, press the presser up button displayed in the presser down screen. * When performing threading in this state, turn OFF the power before performing.
F	BOBBIN WINDER button	Bobbin thread can be wound. → Refer to 11. WINDING BOBBIN THREAD, p.29.
G	PATTERN SELECTION button	Pattern No. being selected at present is displayed on this button and when the button is pressed, the pattern No. change screen is displayed. → Refer to 6. PERFORMING PATTERN NO. SELECTION, p.20.
H	NEEDLE THREAD TENSION SETTING button	Needle thread tension value which is set to the pattern data being selected at present is displayed on this button and when the button is pressed, the needle thread tension change screen is displayed. → Refer to 9. CHANGING NEEDLE THREAD TENSION, p.25.
I	OVEREDGING WIDTH, LEFT SETTING button	Overedging width, left which is set to the pattern data being selected at present is displayed on this button and when the button is pressed, the overedging width, left change screen is displayed.
J	KNIFE GROOVE WIDTH, LEFT SETTING button	Knife groove width, left which is set to the pattern data being selected at present is displayed on this button and when the button is pressed, the knife groove width, left change screen is displayed.
K	DIRECT SELECTION button	When this button is pressed, the screen of pattern No. list registered to the direct selection button is displayed.

	Button and display	Description
L	SEWING DATA CHANGE button	Sewing data list screen is displayed. → Refer to 15. CHANGING SEWING DATA, p.37.
M	WITH/WITHOUT DOUBLE STITCHING SETTING button	With/without double stitching which is set to the pattern data being selected at present is displayed on this button and when the button is pressed the with/without double stitching change screen is displayed.
N	NUMBER OF TIMES OF BASTING SETTING button	Number of times of basting which is set to the pattern data being selected at present is displayed on this button and when the button is pressed, the number of times of basting change screen is displayed.
O	CLOTH CUTTING LENGTH SETTING button	Cloth cutting length which is set to the pattern data being selected at present is displayed on this button and when the button is pressed, the cloth cutting length change screen is displayed.
P	SEWING SHAPE SELECTION button	Sewing shape which is set to the pattern data being selected at present is displayed on this button and when the button is pressed, the sewing shape change screen is displayed. → Refer to 8. PERFORMING SEWING SHAPE SELECTION, p.23.
Q	KNIFE GROOVE WIDTH, RIGHT SETTING button	Knife groove width, right which is set to the pattern data being selected at present is displayed on this button and when the button is pressed, the knife groove width, right change screen is displayed.
R	PRESSER TYPE SELECTION button	Presser type being selected at present is displayed on this button and when the button is pressed, the presser type change screen is displayed. → Refer to 5. INPUTTING PRESSER TYPE, p.18.
S	CUSTOMIZE button	Sewing data which are more frequently used can be laid out to four buttons. When this button is pressed, the laid-out sewing data change screen is displayed. → Refer to 19. REGISTERING SEWING DATA TO CUSTOMIZE BUTTON, p.55.

3-2 Sewing screen

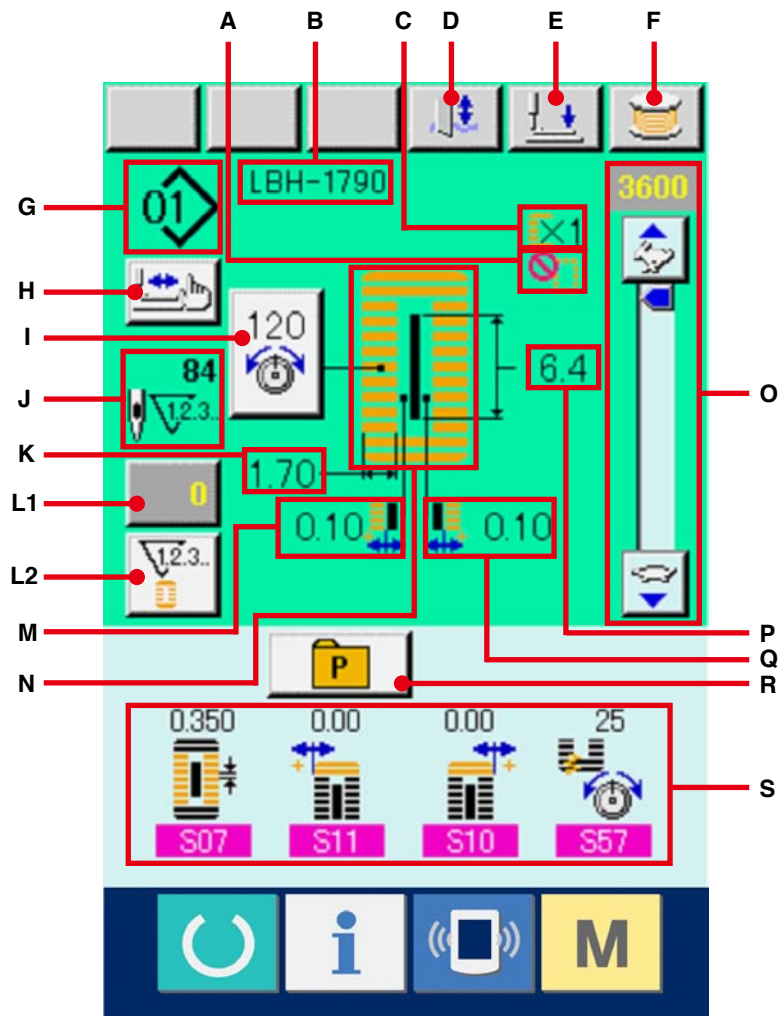

	Button and display	Description
A	NUMBER OF TIMES OF BASTING display	Number of times of basting which is set to the pattern data during sewing is displayed.
B	PATTERN NAME display	Pattern name which is set to the pattern data during sewing is displayed.
C	WITH/WITHOUT DOUBLE STITCHING display	With/without double stitching which is set to the pattern data during sewing is displayed.
D	KNIFE CANCEL button	Every time this button is pressed, dropping of knife and non-dropping of knife can be changed over alternately.
E	PRESSER DOWN button	Presser can be lowered and the knife down screen is displayed. To raise the presser, press the presser up button displayed in the presser down screen. * When performing threading in this state, turn OFF the power before performing.
F	BOBBIN WINDER button	Bobbin thread can be wound. → Refer to 11. WINDING BOBBIN THREAD, p.29 .
G	PATTERN NO. display	Pattern No. during sewing is displayed.
H	STEP STITCHING button	When this button is pressed, the screen of step stitching to check needle entry point and to perform re-sewing is displayed. → Refer to 10. PERFORMING RE-SEWING, p.27 .
I	NEEDLE THREAD TENSION button	Needle thread tension which is set to the pattern data during sewing is displayed, and when this button is pressed, the needle thread tension change screen is displayed. → Refer to 9. CHANGING NEEDLE THREAD TENSION, p.25 .
J	NUMBER OF TOTAL STITCHES display	Number of total stitches of the pattern data during sewing is displayed.
K	OVEREDGING WIDTH, LEFT display	Overedging width, left which is set to the pattern during sewing is displayed.
L1	COUNTER VALUE CHANGE button	Existing counter value is displayed on this button. When the button is pressed, the counter value change screen is displayed. → Refer to 12. USING COUNTER, p. 30 .
L2	COUNTER CHANGE OVER button	Display of sewing counter/No. of pcs. counter can be changed over. → Refer to 12. USING COUNTER, p. 30 .

	Button and display	Description
M	KNIFE GROOVE WIDTH, LEFT display	Knife groove width, left which is set to the pattern during sewing is displayed.
N	SEWING SHAPE display	Sewing shape of the pattern data during sewing is displayed.
O	SPEED variable resistor	Number of rotation of sewing machine can be changed.
P	CLOTH CUTTING LENGTH display	Cloth cutting length which is set to the pattern data during sewing is displayed.
Q	KNIFE GROOVE WIDTH, RIGHT display	Knife groove width, right which is set to the pattern during sewing is displayed.
R	DIRECT SELECTION button	When this button is pressed, the screen of pattern No. list registered to the direct selection button is displayed. Pattern No. during sewing is displayed. ※ At the time of your purchase, the button is set to non-display setting. When you desire to make it display, set <u>K18 Display/non-display setting of direct button to the display state</u> . → Refer to 26. CHANGING MEMORY SWITCH DATA, p.77 .
S	CUSTOMIZE display	Sewing data value which is laid out to the customize button is displayed.

4. HOW TO USE THE PEDAL

This sewing machine can be used by selecting the pedal operating procedure from among 3 types described later. Select the operating procedure you desire for working efficiency and use the sewing machine.

4-1 Setting procedure of the pedal type

① **Call the pedal type setting parameter.**

Hold pressing switch **M** (A) for 6 seconds

and memory switch (level 2) button  (B) is

displayed on the screen. When this button is pressed, the memory switch (level 2) list screen is displayed.

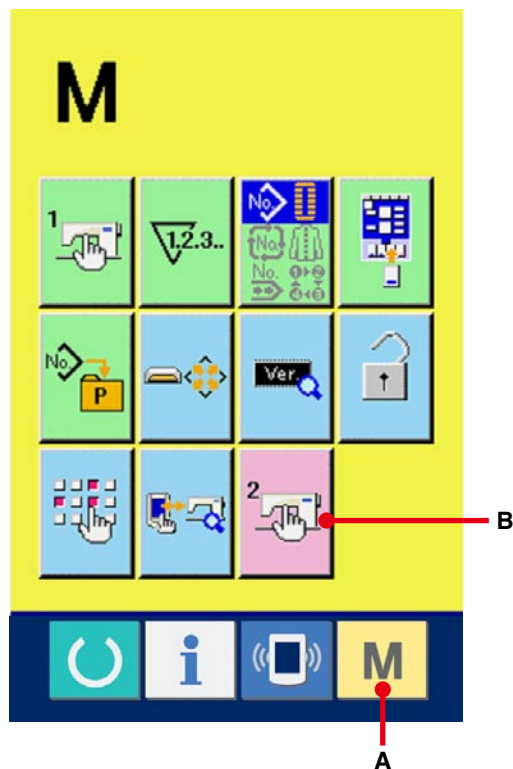

Press button K01  (C) of the pedal type

selection parameter on the memory switch (level 2) list screen and the pedal type change screen is displayed.

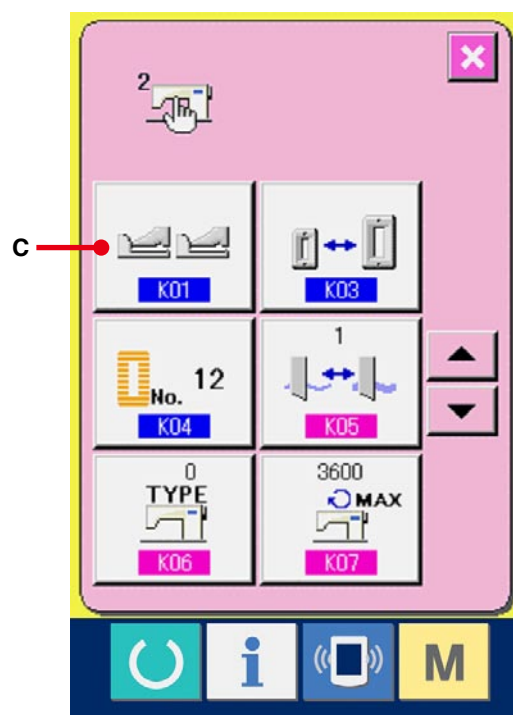

② **Select the pedal type.**

Three kinds of pedal type buttons (D to F) are displayed on the pedal type change screen.

Select the pedal type you desire and press ENTER button  (G). Close the pop-up

and display screen ①. When switch **M** (A) is pressed further, the screen returns to the data edit screen.

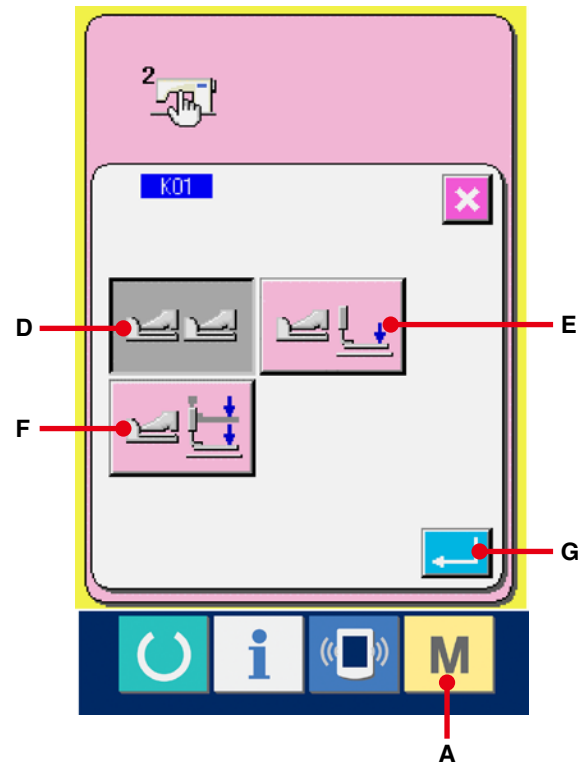

D : 2-pedal



E : 1-pedal (Without intermediate position)



F : 1-pedal (With intermediate position)

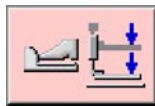

4-2 Explanation of pedal motion

2-pedal type	1-pedal (Without intermediate position)	1-pedal (With intermediate position)
INITIAL POSITION Presser : <u>Intermediate position ②</u> or <u>Sewing position ③</u>	INITIAL POSITION Presser : <u>Maximum position ①</u>	INITIAL POSITION Presser : <u>Maximum position ①</u>
1) SETTING OF SEWING PRODUCT Presser goes up as high as the pedal toe down amount of the left side pedal.	1) SETTING OF SEWING PRODUCT 2) CONFIRMATION OF SETTING OF SEWING PRODUCT Presser comes down to <u>Cloth setting position ③</u> when the first step of the right side pedal is depressed.	1) SETTING OF SEWING PRODUCT 2) CONFIRMATION OF SETTING OF SEWING PRODUCT Presser comes down to <u>Intermediate position ②</u> when the first step of the right side pedal is depressed.
2) START OF SEWING Sewing starts when the right side pedal is depressed.	3) START OF SEWING Sewing starts when the second step of the right side pedal is depressed.	3) CONFIRMATION OF START OF SEWING Presser comes down to <u>Cloth setting position ③</u> when the second step of the right side pedal is depressed.
3) END OF SEWING Presser automatically goes up to <u>Intermediate position ②</u> .	4) END OF SEWING Presser automatically goes up to <u>Maximum position ①</u> .	4) START OF SEWING Sewing starts when the third step of the right side pedal is depressed.
		5) END OF SEWING Presser automatically goes up to <u>Maximum position ①</u> .

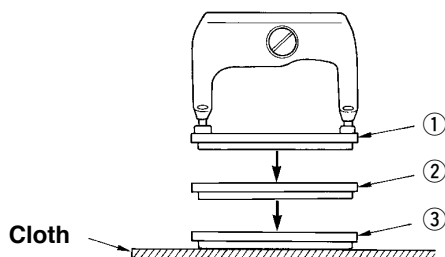

※ Height of the respective positions of ① to ③ described on the left side can be set or changed by the memory switches.

→ [26. METHOD OF CHANGING MEMORY SWITCH DATA, p.77.](#)

● Pedal switch setting

Attach or remove the screw shown in the figure according to the setting of the memory switch.

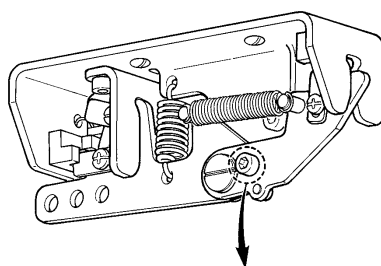

2-pedal type

1-pedal (Without intermediate position)

Remove the screw.



1-pedal (With intermediate position)

Attach the screw.



5. INPUTTING THE PRESSER TYPE

5-1 Setting procedure of the presser type

① **Display the data input screen.**

Only in case of the data input screen (blue), the contents of setting can be changed. In case of the sewing screen (green), press READY key  and display the data input screen.

② **Call the presser type selection screen.**

Press PRESSER TYPE SELECTION button

 (A) and the presser type selection screen is displayed.

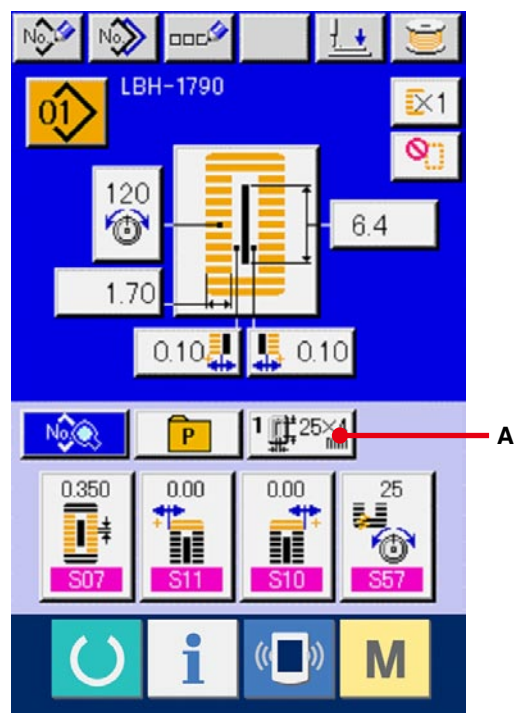

③ **Select the presser type.**

Press button (B) of the presser type mounted on the sewing machine. The button pressed is shown in reverse video. Set the presser type referring to Table of presser type described later.



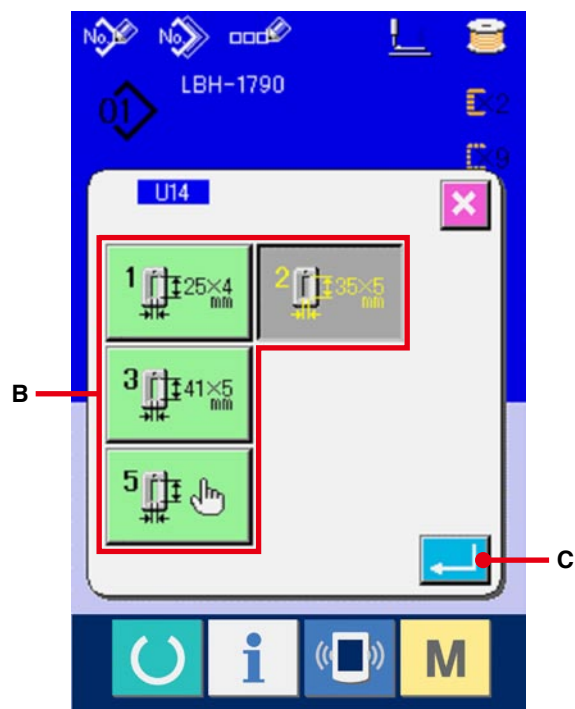

④ **Determine the presser type.**

Press ENTER button  (C) and the presser type change screen is closed. Then the change has been finished.

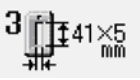

5-2 Table of presser type

Make the number in the frame of engraved part number of presser foot correspond to the type of presser.

	Type	Part No. of presser foot
	Type 1	B 1 5 1 1 7 7 1 0 0 0 *
	Type 2	B 1 5 1 1 7 7 2 0 0 0 *
	Type 3	B 1 5 1 1 7 7 3 0 0 0 *
	Type 5	-

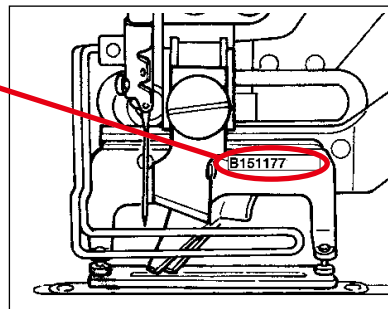

- ※ Set type 5 when using the presser foot other than type 1 to 3. Change **U15** Presser size width and **U16** Presser size length of the memory switch (level 1) to adjust to the presser to be used.
→ Refer to [26. CHANGING MEMORY SWITCH DATA, p.77](#).
- ※ When using type 5 with stitch width of 6 mm or more and 41 mm or more in length, it is necessary to replace components such as presser arm, feed plate, etc.

6. PERFORMING PATTERN NO. SELECTION

6-1 Selection from the data input screen

① **Display the data input screen.**

Only in case of the data input screen (blue), the contents of setting can be changed. In case of the sewing screen (green), press READY key  and display the data input screen.

② **Call the PATTERN NO. SELECTION screen.**

Press PATTERN NO. SELECTION button  (A) and the pattern No. selection screen is displayed. Pattern No. which is selected at present and the contents are displayed in the upper part of the screen and the list of the pattern No. buttons which have been registered is displayed in the lower part.

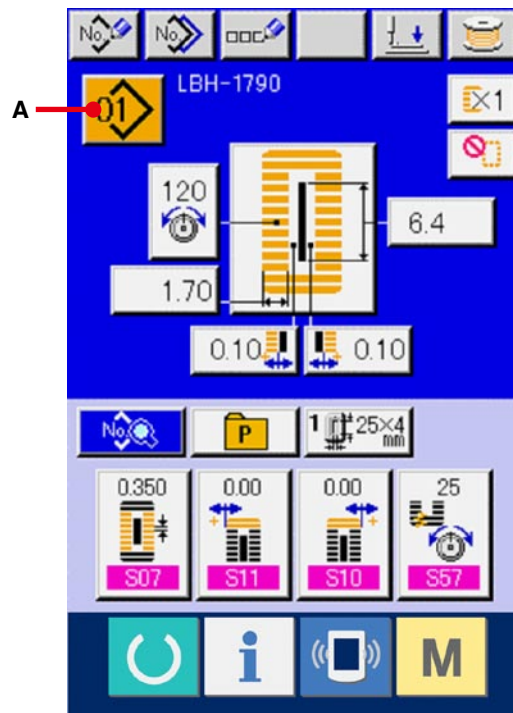

③ **Select the pattern No.**

When UP or DOWN SCROLL button  (B) is pressed, the pattern No. buttons (C) which have been registered are changed over in order. The contents of the sewing data inputted in the pattern No. are displayed in the button. Here, press the pattern No. button (C) you desire to select.

④ **Determine the pattern No.**

Press ENTER button  (D), and the pattern No. selection screen is closed. Then the selection has been finished.

※ When you desire to delete the registered pattern, press DELETE button  (E).

However, the pattern which is registered to continuous stitching and cycle stitching cannot be deleted.

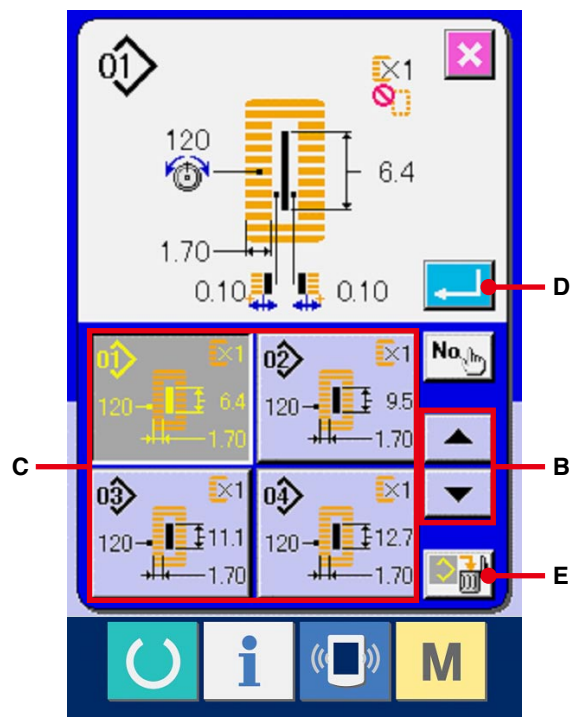

6-2 Selection by means of DIRECT button

This sewing machine can register the pattern No. you desire to DIRECT button.

When the pattern has been registered, the pattern selection can be simply performed only by pressing the button.

→ Refer to [18. REGISTERING THE PATTERN TO DIRECT BUTTON, p.53](#).

① Display the direct button selection screen.

Press DIRECT button  (A) in the data input screen (blue) and display the DIRECT button selection screen.

※ When the display is selected with the display/non-display of the direct button of the memory switch (level 2)  DIRECT button can be used even in the sewing screen.

→ Refer to [26. CHANGING MEMORY SWITCH DATA, p.77](#).

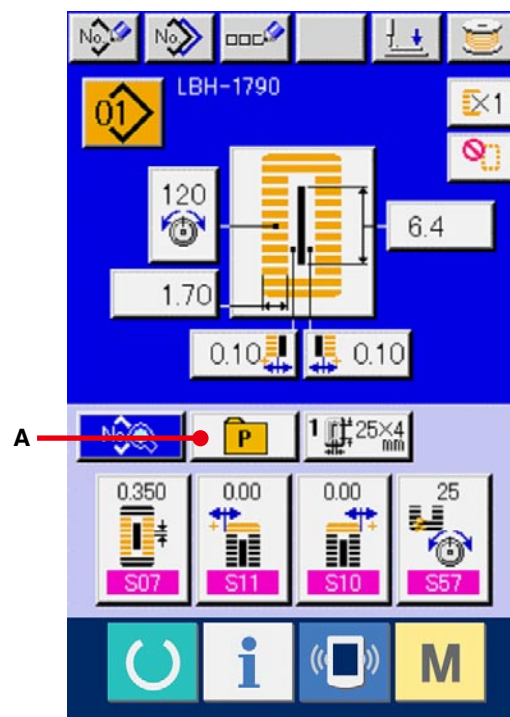

② Select the pattern No.

The pattern Nos. which have been registered to DIRECT button can be selected. Press the PATTERN NO. button (B) you desire to select and the direct button selection screen is closed. Then the selected pattern No. is displayed.

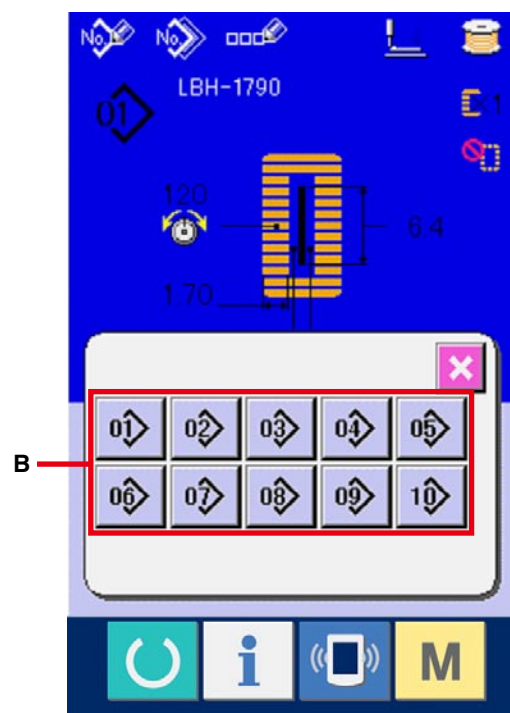

7. NAMING THE PATTERN

As many as 14 characters can be inputted to the patterns respectively.

① Display the data input screen.



Only in case of the data input screen (blue), input of the pattern name can be performed. In case of the sewing screen (green), press READY switch  and display the data input screen (blue).

② Call the character input screen.

Press CHARACTER INPUT button  (A) and the character input screen is displayed.

③ Input the character.

Press the character button (B) you desire to input, and input of the character can be performed.

Characters (A to Z and 0 to 9) and symbols (+, -, /, #, ...) can be inputted. As many as 14 characters can be inputted. The cursor can travel with CURSOR LEFT TRAVEL button  (C) and CURSOR RIGHT TRAVEL button  (D).

When you desire to delete the inputted character, adjust the cursor to the position of the character you desire to delete and press DELETE button  (E).

④ Finish inputting the character.

Press ENTER button  (F) and inputting the character is finished. After the finish, the inputted character is displayed in the upper part of the data input screen (blue).

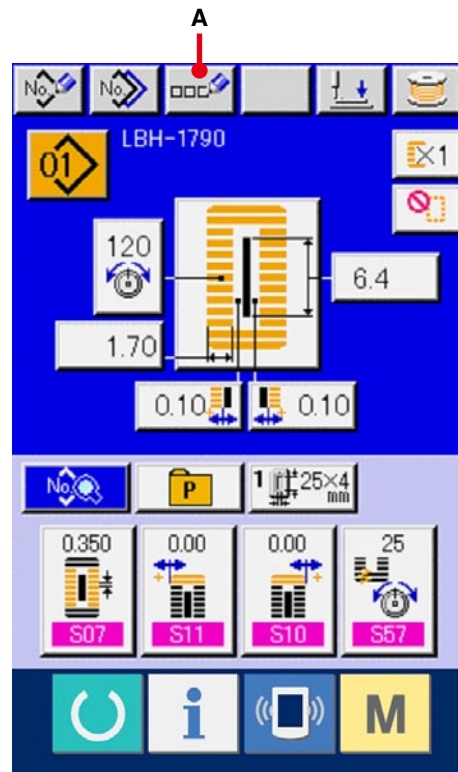

8. PERFORMING SEWING SHAPE SELECTION

① Display the data input screen.

Only in case of the data input screen (blue), the selection of sewing shape can be performed. In case of the sewing screen (green), press READY switch  and display the data input screen (blue).

② Call the sewing shape selection screen.

Press SEWING SHAPE button  (A) and the sewing shape selection screen is displayed.

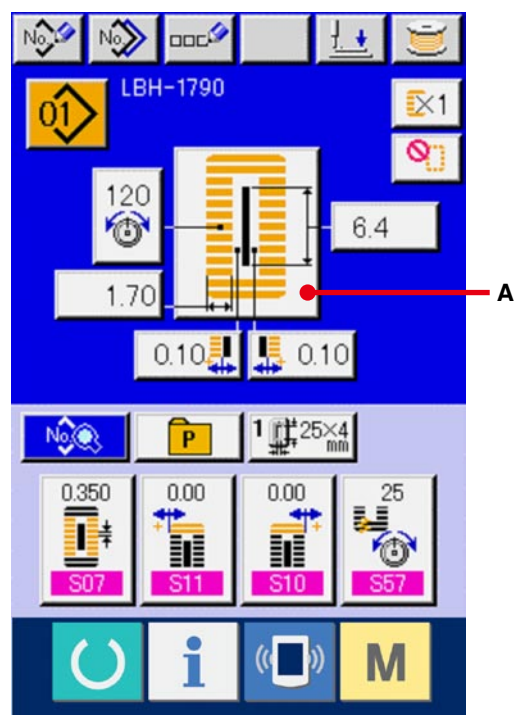

③ Select the 1st bar-tacking section.

Select the shape you desire to sew from among 5 kinds of the 1st bar-tacking shape buttons (B). When it is selected, the total sewing shape in which the selected 1st bar-tacking is used is displayed.

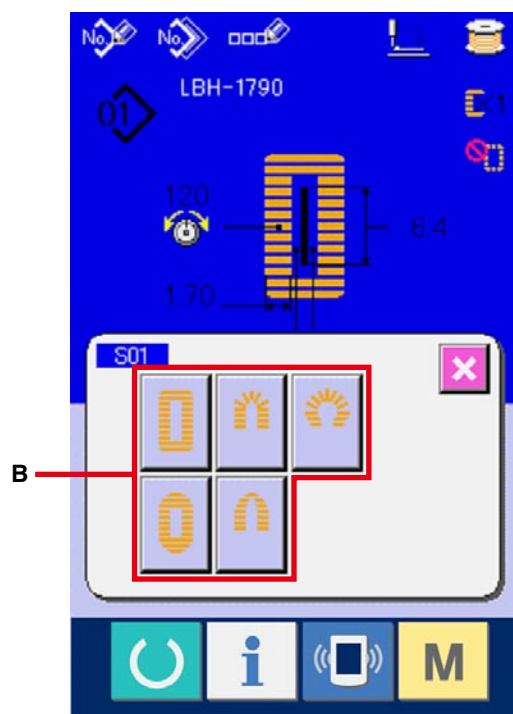

④ **Select the sewing shape.**

Select SEWING SHAPE button (C) you desire to sew.

⑤ **Finish the sewing shape selection.**

Press ENTER button  (D) to finish the shape selection and the selected sewing shape is displayed in the data input screen (blue).

Note) The number of sewing shapes to be displayed changes according to the level selected in the sewing shape selection level of memory DIP switch (level 2)  .

→ Refer to [26. CHANGING MEMORY SWITCH DATA, p.77.](#)

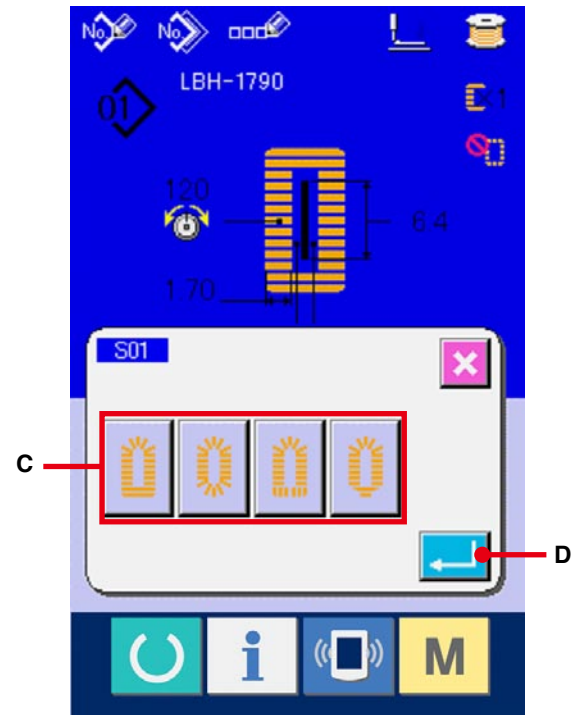

9. CHANGING NEEDLE THREAD TENSION

① Display the data input screen.

Only in case of the data input screen (blue), needle thread tension can be changed. In case of the sewing screen (green), press READY switch  and display the data input screen (blue).

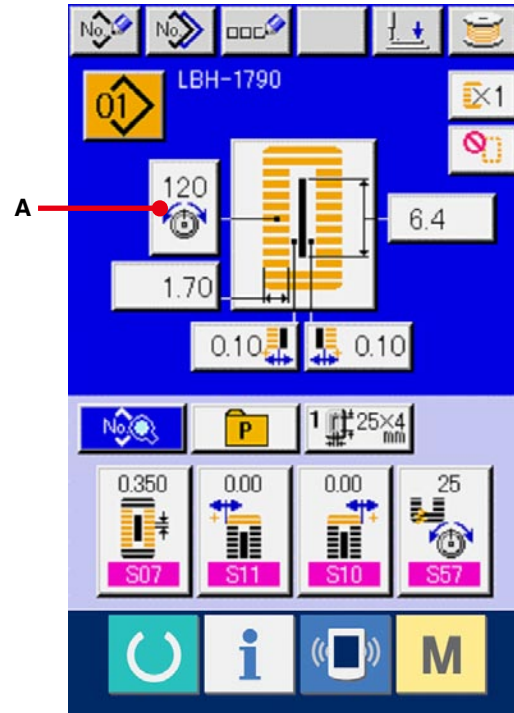

② Call the needle thread tension change screen.

Press NEEDLE THREAD TENSION button  (A) and the needle thread tension change screen is displayed.



③ Change the needle thread tension.

Needle thread tension at the parallel section and that at the bar-tacking section can be changed in the needle thread tension change screen.

Change the tension value with UP button  (B) or DOWN button  (C) corresponding to the respective sections.

④ Finish the change of needle thread tension.

Press CANCEL button  (D) and the needle thread tension change screen is closed. Then the change has been finished.

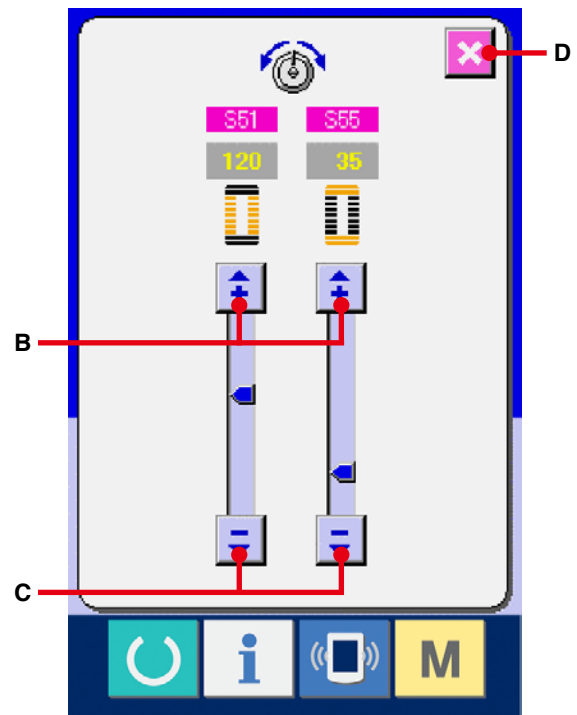

※ For the tension other than that at parallel section and at bar-tacking section, refer to [15. CHANGING SEWING DATA, p.37](#) and [26. CHANGING MEMORY SWITCH DATA, p.77](#).

Set value of tension at ① parallel section and ② bar-tacking section

	Set value on panel			
		⊖	Initial value	⊕
Purl stitch	① Parallel section tension	Crest is lowered.	120	Crest is raised.
	② Bar-tacking tension	Thread tension is decreased.	35	Thread tension is increased.
Whip stitch	① Parallel section tension	Thread tension is decreased.	60	Thread tension is increased.
	② Bar-tacking tension	Thread tension is decreased.	60	Thread tension is increased.

In case of the radial eyelet shape, set the bar-tacking tension first to approximately 120 and make the balance of stitches.

Purl stitch and Whip stitch

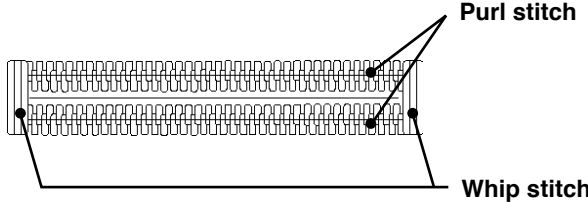
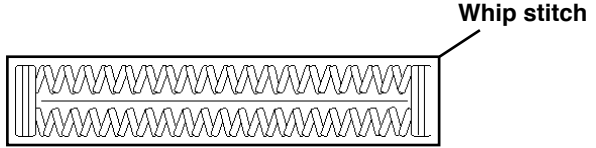
	<p>Purl stitch When applying higher tension to the needle thread to permit it to pass straight through fabric, the purl stitch is formed by the bobbin thread which is pulled over from both sides to the center line.</p>
	<p>Whip stitch The whip stitch is formed in zigzag showing the needle thread only on top of fabric, and the bobbin thread on the bottom.</p>

10. PERFORMING RE-SEWING

When STOP switch (A) is pressed during sewing, the sewing machine interrupts sewing and stops. At this time, the error screen is displayed to inform that the STOP switch is pressed.

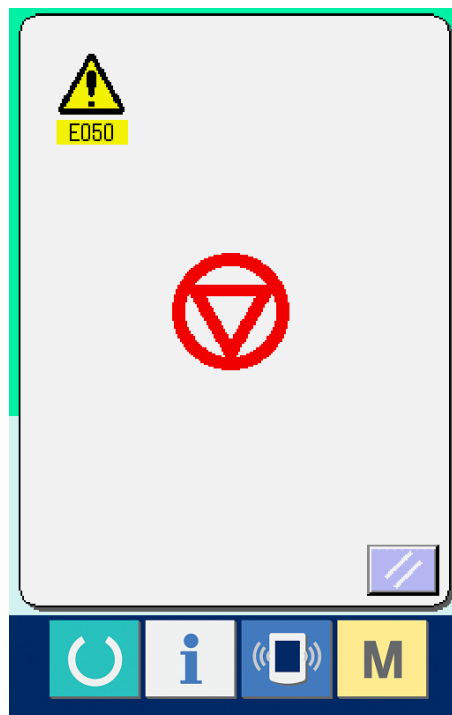
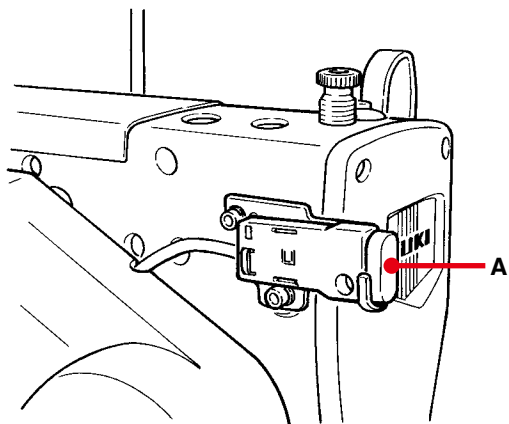

10-1 To continue performing sewing from some point in sewing

① Release the error.

Press RESET button  (B) to release the error. Then the step motion screen is displayed.

② Return the presser.

Press BACKWARD button (C), and the presser returns stitch by stitch.

Press FORWARD key (D), and the presser advances stitch by stitch. Return the presser to the re-sewing position.

③ Start sewing again.

Depress the right side pedal and sewing starts again.

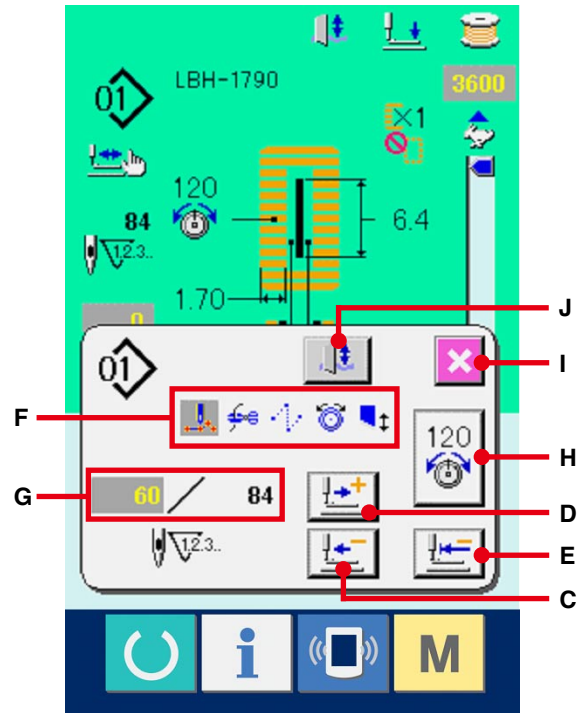



10-2 To perform sewing from the start

① Release the error.

Press RESET button  (B) to release the error. Then the step motion screen is displayed.

② Return the sewing product to the setting position.

Press INITIAL POSITION TRAVEL button  (E) and the presser returns to the sewing product setting position (start position).

Press CANCEL button  (I) to close the pop-up and the presser returns to the sewing product setting position (start position).

③ Start the sewing.

When the right pedal is depressed, sewing starts again.

* In case of the continuous stitching, (E) moves to the sewing start position of the shape during sewing and when it is pressed subsequently, it moves to the sewing start position of the previous shape.

* The existing sewing commands are shown in reverse video in section (F). The kinds of commands are 5 kinds below.

 : Sewing command

 : Thread trimming command

 : Jump feed

 : Thread tension

 : Knife drive

* The existing number of stitches/number of total stitches are displayed in section (G).

* Thread tension value is displayed in section (H). When thread tension command is inputted in the needle entry point by means of the external input device, the button is displayed and thread tension can be changed.

* Knife can be cancelled with (J).

11. WINDING BOBBIN THREAD

① Set the bobbin.

Fit a bobbin fully onto the bobbin winder shaft. Then push the bobbin thread guide in the direction of the arrow mark.

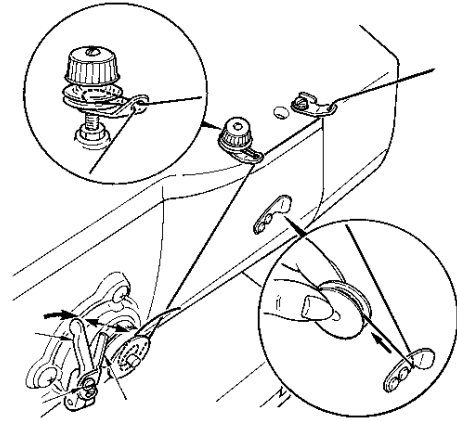

② Display the bobbin winding screen.

Press BOBBIN WINDER button  (A) in the data input screen (blue) or the sewing screen (green) and the bobbin winding screen is displayed.

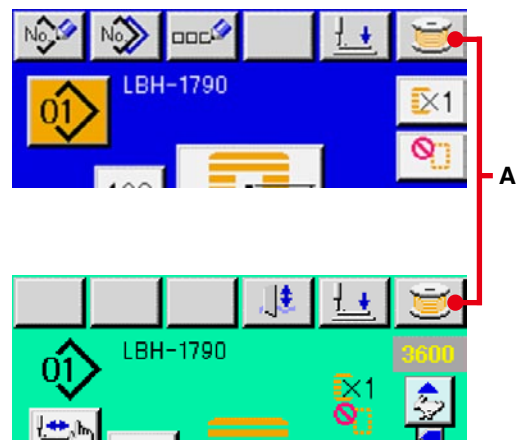

③ Start bobbin winding.

Depress the start pedal, and the sewing machine rotates and starts winding bobbin thread.

④ Stop the sewing machine.

Press STOP button  (B) and the sewing machine stops and returns to the normal mode. Or, depress the start pedal twice during winding bobbin and the sewing machine stops while the bobbin thread winding mode stays as it is. Depress the start pedal again and the bobbin winding starts again. Use this way when winding bobbin thread around plural bobbins.

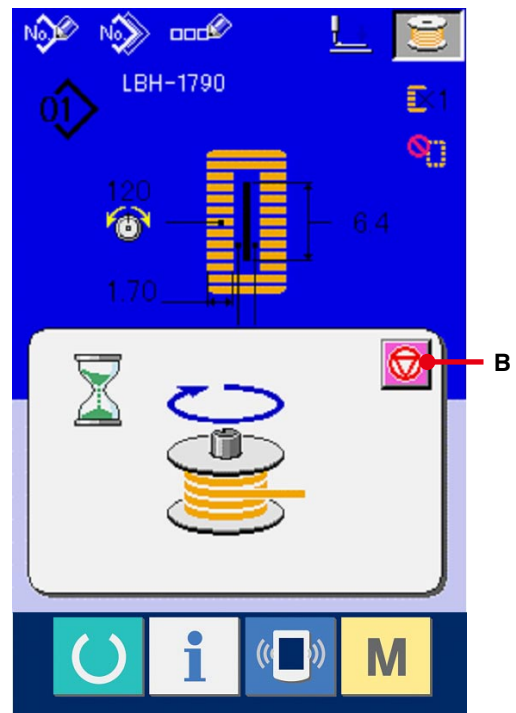

When winding the bobbin thread in the state that sewing is not performed, remove the needle thread from the thread path of thread take-up and remove the bobbin from the hook.

12. USING COUNTER

12-1 Setting procedure of the counter

① Display the counter setting screen.

Press **M** switch and the COUNTER SETTING button  (A) is displayed on the screen. When this button is pressed, the counter setting screen is displayed.

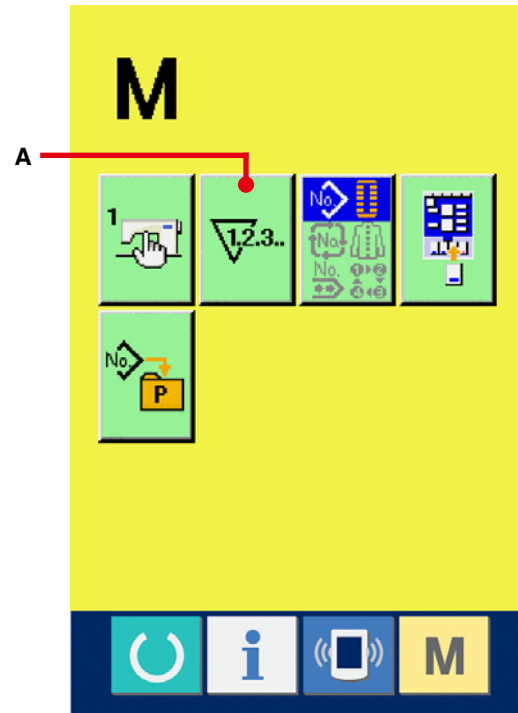

② Selection of kinds of counters

This sewing machine has two kinds of counters, i.e., sewing counter and No. of pcs. counter.

Press SEWING COUNTER KIND SELECTION button

button  (B) or NO. OF PCS. KIND SELECTION button

button  (C) to display the counter kind selection screen. The kinds of the respective counters can be set separately.

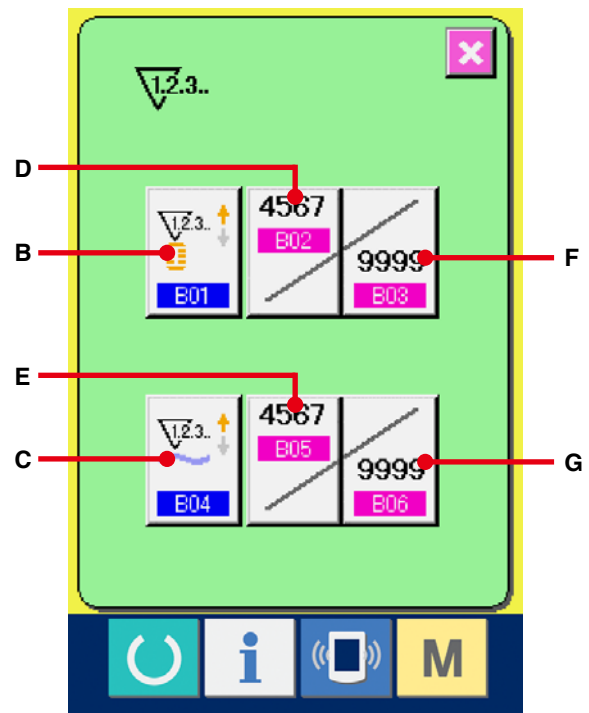

[Sewing counter]

UP counter  :

Every time the sewing of one shape is performed, the existing value is counted up. When the existing value is equal to the set value, the count-up screen is displayed.

DOWN counter  :

Every time the sewing of one shape is performed, the existing value is counted down. When the existing value is reached to "0", the count-up screen is displayed.

Counter not used 

[No. of pcs. counter]

UP counter  :

Every time one cycle or one continuous stitching is performed, the existing value is counted up. When the existing value is equal to the set value, the count-up screen is displayed.



DOWN counter  :

Every time one cycle or one continuous stitching is performed, the existing value is counted down. When the existing value is reached to "0", the count-up screen is displayed.

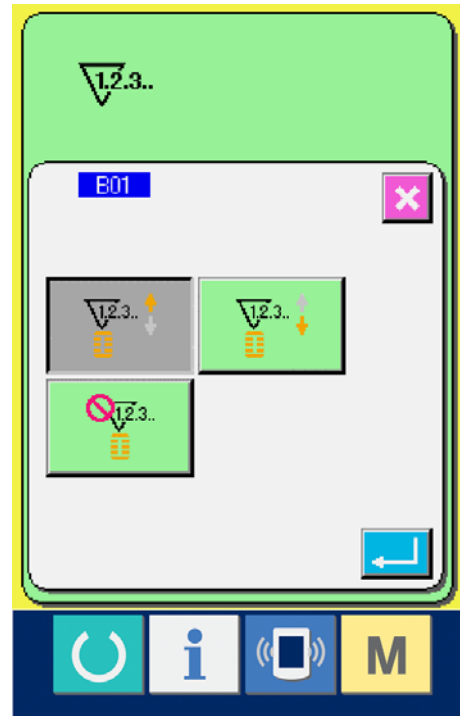
Counter not used 





③ Change of counter set value

In case of the sewing counter, press button  (F) and in case of the No. of pcs. counter, press button  (G) and the set value input screen is displayed.

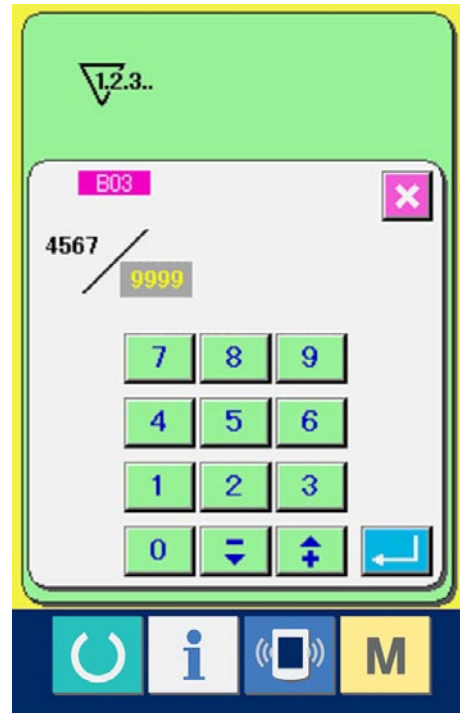
Here, input the set value. (See p.30.)



④ Change of counter existing value

In case of the sewing counter, press button  (D) and in case of the No. of pcs. counter, press button  (E) and the existing value input screen is displayed.

Here, input the existing value. (See p.30.)

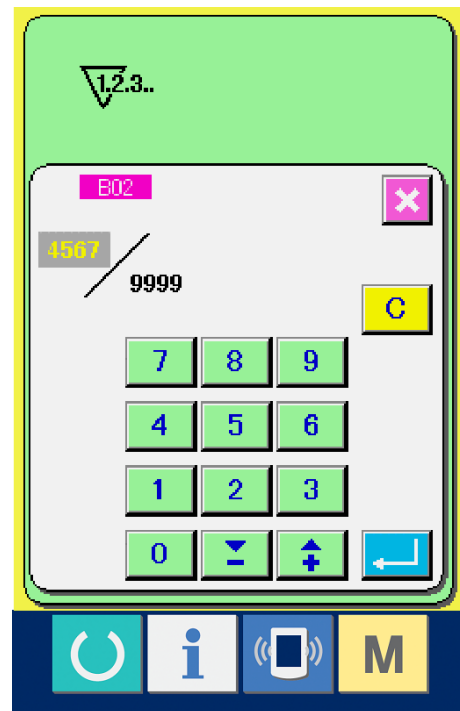

12-2 Count-up releasing procedure

When count-up condition is reached during sewing work, the count-up screen is displayed and the buzzer beeps. Press CLEAR button **C** (H) to reset the counter and the screen returns to the sewing screen. Then the counter starts counting again.

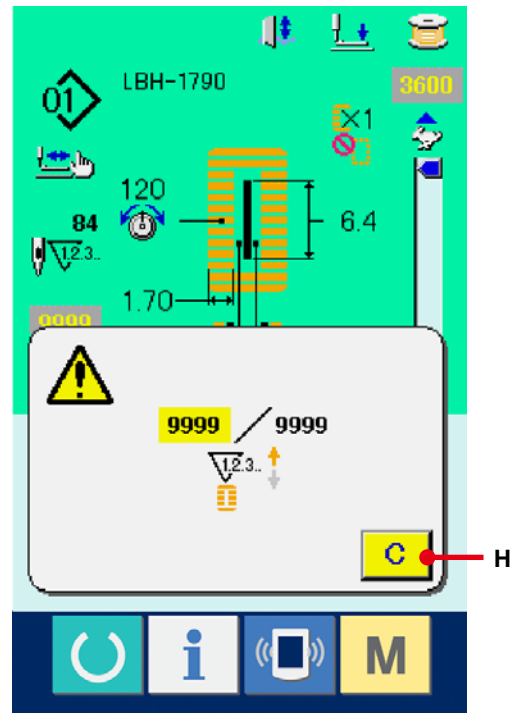

13. PERFORMING NEW REGISTRATION OF THE PATTERN

① **Display the data input screen.**

Only in case of the data input screen (blue), new registration of the pattern can be performed. In case of the sewing screen (green), press READY switch  and display the data input screen (blue).

② **Call the pattern new registration screen.**

Press NEW REGISTRATION button  (A) and the pattern new registration screen is displayed.

③ **Input the pattern No.**

Input the pattern No. you desire to newly register with the ten keys (B). When the pattern No. which has been already registered is inputted, the sewing shape which has been registered is displayed in the upper part of the screen. Select the pattern No. which is not displayed and has not been registered. New registration to the pattern No. which has been already registered is prohibited.

It is possible to retrieve the pattern No. which has not been registered with the - • + button 

 (C • D).

④ **Determine pattern No.**

Press ENTER button  (E) to determine the pattern NO. to be newly registered and the screen of 1st bar-tacking shape list is displayed.

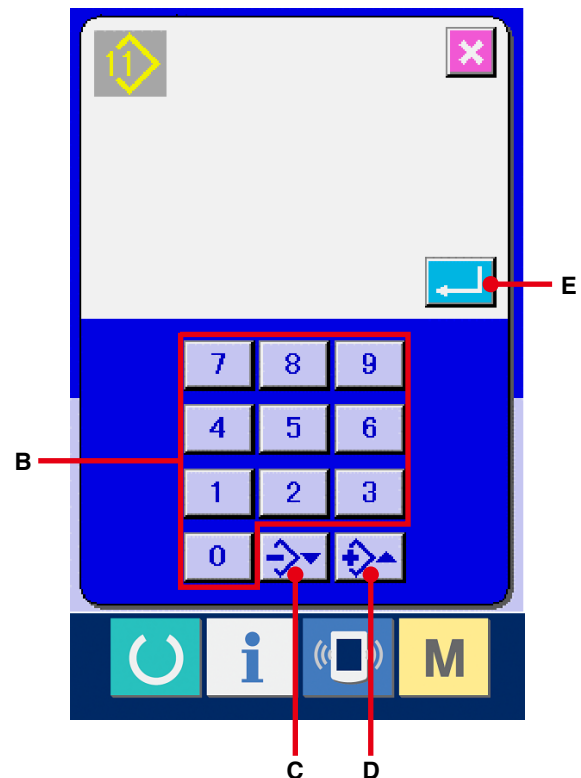
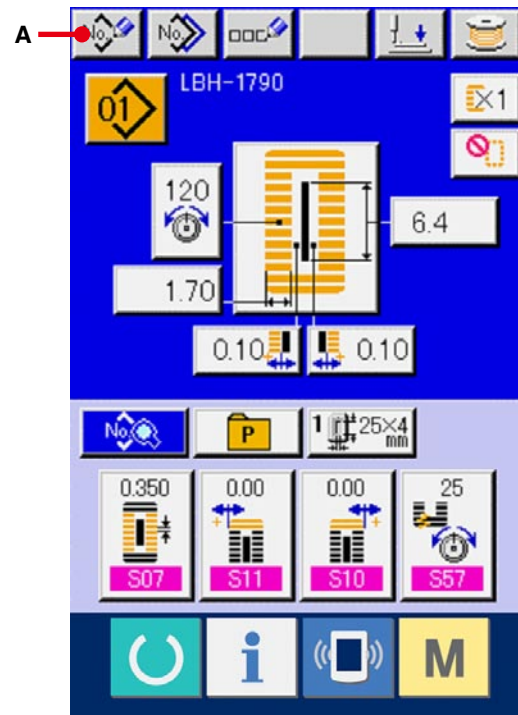

⑤ **Select the 1st bar-tacking shape.**

Select the shape you desire to sew from among 5 kinds of the 1st bar-tacking shape buttons (F).

When it is selected, the total sewing shape in which the 1st bar-tacking shape is used is displayed.

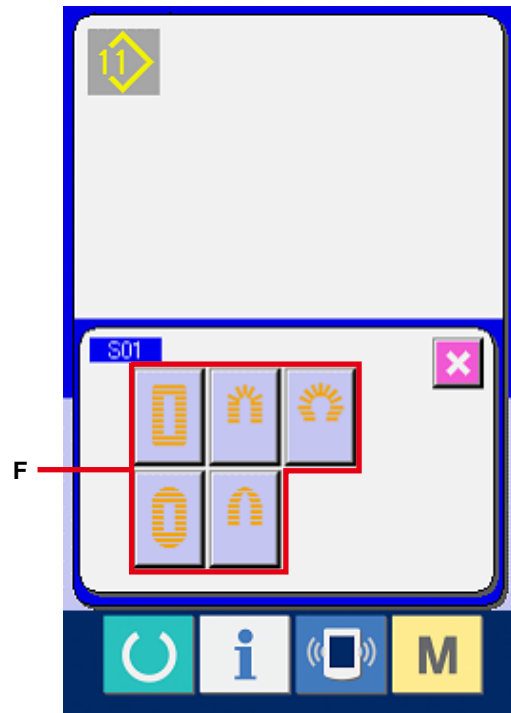

⑥ **Select the sewing shape.**

Select SEWING SHAPE button (G) you desire to sew.

⑦ **Finish the selection of sewing shape.**





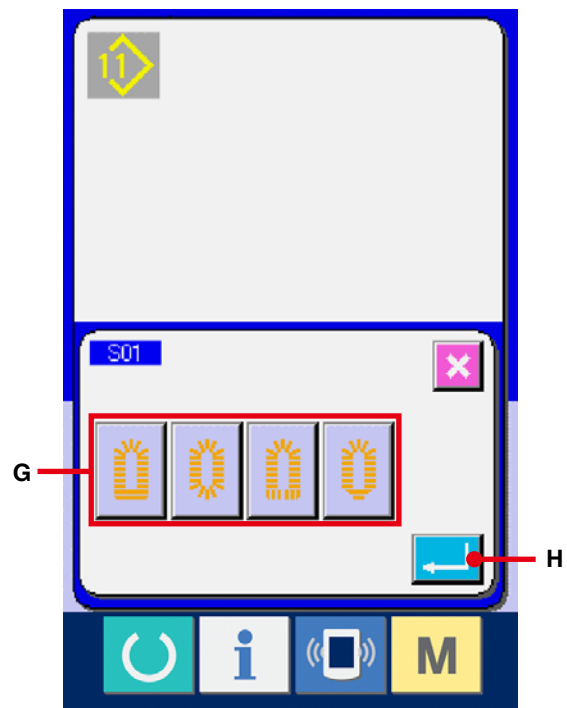

























Press ENTER button  (H) to finish the selection of the shape. Then the sewing shape which has been selected is displayed in the data input screen (blue). The initial value of sewing data is inputted according to the selected sewing shape.

Note) Number of sewing shapes to be displayed changes according to the level selected in the sewing shape selection level of memory DIP switch (level 2) **K04** .

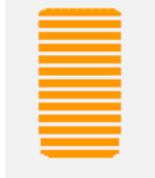

→ Refer to [26. CHANGING MEMORY SWITCH DATA, p.77.](#)

14. SEWING SHAPE LIST

1) Square type 	2) Round type 	3) Radial square type 	4) Radial type 	5) Radial straight bar-tacking type 
6) Radial taper bar-tacking type 	7) Eyelet square type 	8) Eyelet radial type 	9) Eyelet straight bar-tacking type 	10) Eyelet taper bar-tacking type 
11) Semilunar type 	12) Round square type 	13) Semilunar square type 	14) Semilunar straight bar-tacking type 	15) Semilunar taper bar-tacking type 
16) Eyelet semilunar type 	17) Eyelet round type 	18) Square radial type 	19) Square semilunar type 	20) Square round type 
21) Square straight bar-tacking type 	22) Square taper bar-tacking type 	23) Radial semilunar type 	24) Radial round type 	25) Semilunar radial type 
26) Semilunar round type 	27) Bar-tacking type 	28) Bar-tacking, right cut 	29) Bar-tacking, left cut 	30) Bar-tacking, center cut 

15. CHANGING SEWING DATA

15-1 Initial sewing data at the time of your purchase

Patterns from 1 to 10 have been already registered at the time of your purchase. The initial values of the square type shape which are different in the cloth cutting length only have been inputted in the sewing data.

→ For the initial values of the square type shape, refer to “13. INITIAL VALUE DATA FOR EACH SHAPE TABLE” in the Instruction Manual supplied with the device.

Pattern No.	Cloth cutting length S02
1	6.40 mm (1/4")
2	9.50 mm (3/8")
3	11.10 mm (7/16")
4	12.70 mm (1/2")
5	14.30 mm (9/16")
6	15.90 mm (5/8")
7	17.50 mm (11/16")
8	19.10 mm (3/4")
9	22.20 mm (7/8")
10	25.40 mm (1")

15-2 Changing procedure of sewing data

① Display the data input screen.

Only in case of the data input screen (blue), change of the sewing data can be performed.

In case of the sewing screen (green), press

READY switch  and display the data input screen (blue).

② Call the sewing data screen.

Press SEWING DATA button  (A) and the sewing data screen is displayed.

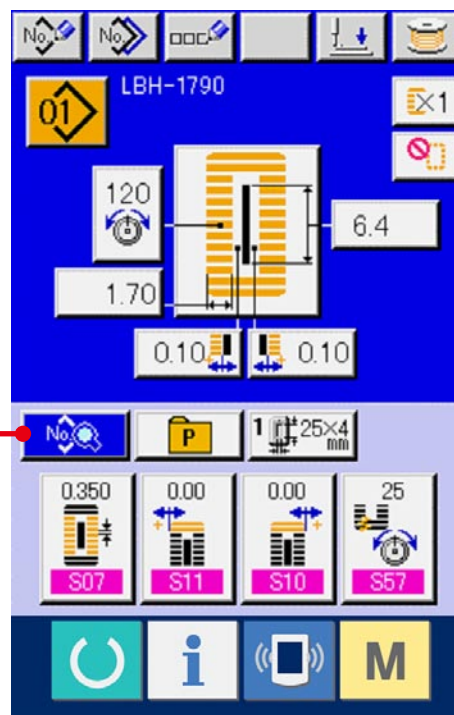

③ Select the sewing data to be changed.

Press UP/DOWN SCROLL button  (B) and select SEWING DATA ITEM button (C) you desire to change. Data item not used according to the shape and data item which is set to without function are not displayed. So, be careful.

→ Refer to [16. SETTING PROCEDURE OF SEWING DATA WITH/WITHOUT EDIT, p.50.](#)

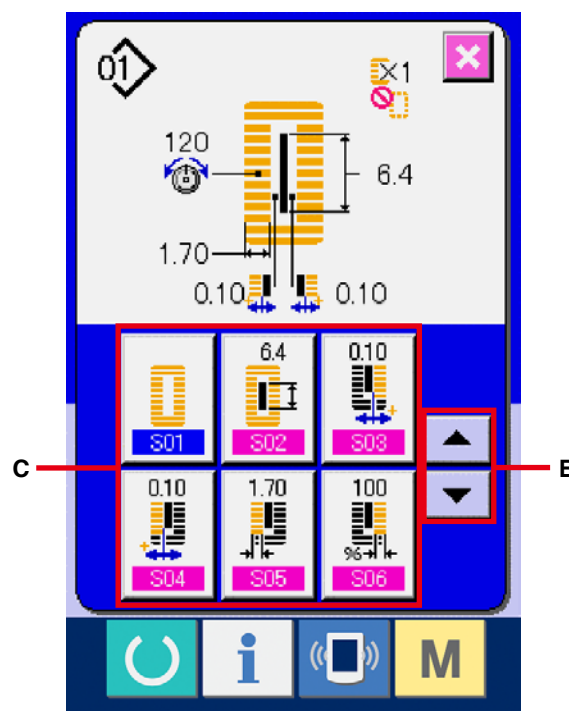

④ **Change the data.**

For the sewing data, there are the data item to change the numeral and data item to select the pictograph. No. in pink color such as **S02** is put on the data item to change the numeral and the set value can be changed with the +/- button which is displayed in the change screen. No. in blue color such as **S20** is put on the data item to select the pictograph and the pictograph which is displayed in the change screen can be selected. For the details of the sewing data, refer to [15-3 Sewing data list, p.40](#).

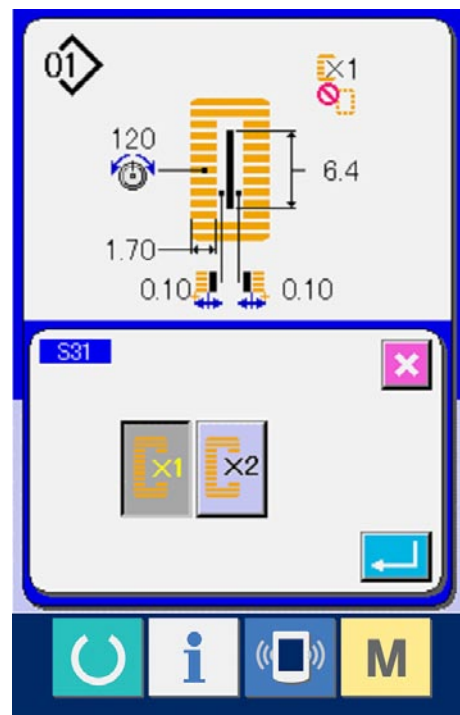
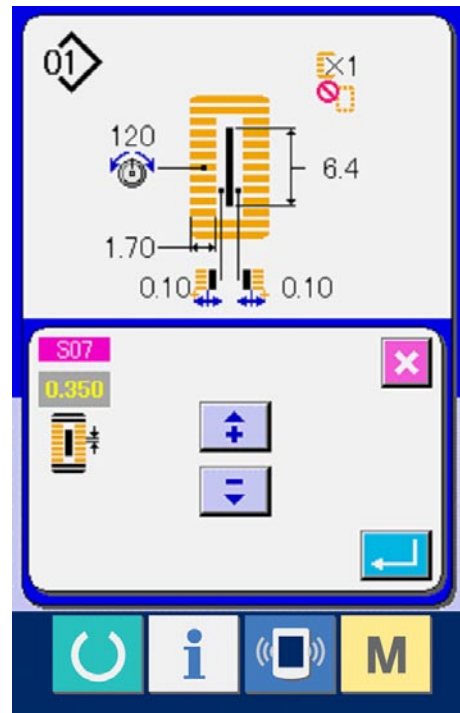



15-3 Sewing data list

Sewing data are those that can be inputted to 99 patterns from pattern 1 to 99 and can be inputted to each pattern.

The sewing machine has been set in the state that the data which is necessary to set "With/ without edit" cannot be set at the time of your purchase. Change over the function to "With edit" if necessary for use.

→ Refer to [16. SETTING PROCEDURE OF SEWING DATA WITH/WITHOUT EDIT, p.50.](#)

No.	Item	Setting range	Edit unit	Remarks
S01	<p>Sewing shape</p> <p>This item selects the shape from among the sewing shapes of 30 different kinds which the sewing machine has.</p> <p>→ Refer to 14. SEWING SHAPE LIST, p.36.</p>  <p>※ Only 12 kinds of standard sewing shapes can be selected at the time of your purchase. When increasing the kinds of shapes, perform setting of K04 Sewing shape selection level of memory switch data.</p> <p>→ Refer to 26-2 Memory switch list, p.79.</p>	1 to 30	1	---
S02	<p>Cloth cut length</p> <p>This item sets the length of cloth that is cut by cloth cutting knife. However, in case of bar-tack shape (Nos. 27, 28, 29 and 30 of S01), sewing length is set.</p>  <p>By making effective U19 Function of plural motions of cloth cutting knife of memory switch data, make the plural motions of knife by the knife size set in the item U18 Cloth cutting knife size, and the sewing product is cut.</p> <p>→ Refer to 26-2 Memory switch data list, p.79.</p>	3.0 to 120.0	0.1mm	---
S03	<p>Knife groove width, right</p> <p>This item sets the clearance between cloth cutting knife and right parallel section.</p> 	-2.00 to 2.00	0.05mm	---















(Remarks)









※ 1 : Displayed according to the shape.







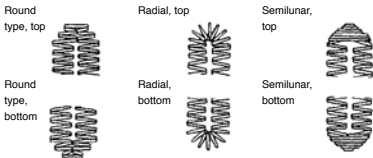





※ 2 : Displayed when it is set to with edit.

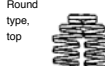
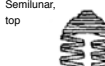

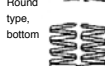
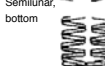
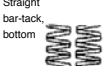







Refer to [16. SETTING PROCEDURE OF SEWING DATA WITH/WITHOUT EDIT, p.50.](#)





※ 3 : Displayed when the function is selected.

No.	Item	Setting range	Edit unit	Remarks
S04	Knife groove width, left This item sets the clearance between cloth cutting knife and left parallel section. 	-2.00 to 2.00	0.05mm	---
S05	Overedging width, left This item sets the overedging width of left parallel section. 	0.10 to 5.00	0.05mm	---
S06	Ratio of right and left shapes This item sets enlargement/reduction ratio of right side shape making the knife position as the center. 	50 to 150	1%	---
S07	Pitch at parallel section This item sets sewing pitch of left and right parallel sections. 	0.200 to 2.500	0.025mm	---
S08	2nd bar-tacking length This item sets length of bar-tacking on the front side.  Square type, bottom  Straight bar-tack, bottom  Flow, bottom 	0.2 to 5.0	0.1mm	---
S09	1st bar-tacking length This item sets length of bar-tacking on the rear side.  Square type, top 	0.2 to 5.0	0.1mm	---
S10	Compensation of bar-tacking width, right This item adjusts left side outer shape of bar-tacking section in terms of overedging section. Both 1st and 2nd bar-tacking can be compensated.  Straight bar-tack, bottom  Square type, top  Square type, bottom 	-1.00 to 1.00	0.05mm	---
S11	Compensation of bar-tacking width, left This item adjusts left side outer shape of bar-tacking in terms of overedging section. 	-1.00 to 1.00	0.05mm	---









No.	Item	Setting range	Edit unit	Remarks
S12	Flow bar-tacking offset, left This item sets length to form bar-tacking section of flow bar-tacking shape. 	0.00 to 3.00	0.05mm	※1
S13	Flow bar-tacking offset, right This item sets length to form bar-tacking section of flow bar-tacking shape. 	0.00 to 3.00	0.05mm	※1
S14	Eyelet shape length This item sets upper side length from center of eyelet of eyelet shape. 	1.0 to 10.0	1	※1
S15	Number of stitches of eyelet shape This item sets number of stitches in the upper 90° of eyelet shape. 	1 to 8	0.1mm	※1
S16	Eyelet width This item sets crosswise size of the inside of eyelet shape. Actual needle entry point is the dimension to which S04 Knife groove width, left is added. 	1.0 to 10.0	0.1mm	※1
S17	Eyelet length This item sets lengthwise size of the inside of eyelet shape. 	1.0 to 10.0	0.1mm	※1
S18	Round type shape length This item sets upper side length from the center of round type shape.  	1.0 to 5.0	0.1mm	※1
S19	Number of stitches of radial shape This item sets number of stitches in the upper 90° of radial shape. 	1 to 8	1	※1









No.	Item	Setting range	Edit unit	Remarks
S20	<p>Reinforcement of radial shape This item sets with / without reinforcement stitching of radial shape.</p> <p> : With  : Without</p>	---	---	※1, ※2
S21	<p>Pitch at bar-tacking section This item sets sewing pitch of bar-tacking section.</p> <p></p> <p>  Square type, top  Round type, top  Semilunar, top  Square type, bottom  Round type, bottom  Semilunar, bottom  Straight bar-tack, bottom  Flow, bottom </p>	0.100 to 2.500	0.025mm	---
S22	<p>1st clearance This item sets the clearance between 1st bar-tacking and knife groove. This item is applied to all shapes.</p> <p></p>	0.0 to 4.0	0.1mm	---
S23	<p>2nd clearance This item sets the clearance between 2nd bar-tacking and knife groove. This item is applied to all shapes.</p> <p></p>	0.0 to 4.0	0.1mm	---
S31	<p>Single/double stitching This item selects single or double stitching.</p> <p> X1 : Single stitching  X2 : Double stitching</p>	---	---	---





No.	Item	Setting range	Edit unit	Remarks
S32	Double stitching cross selection This item selects overlapped stitching or cross stitching at the needle entry of parallel section when setting double stitching.  : Overlapped stitching  : Cross stitching	---	---	※3
S33	Compensation of double stitching width This item sets amount to narrow overedging width of 1st cycle when setting double stitching. 	0.0 to 2.0	0.1mm	※3
S34	Number of times of basting This item sets number of times of basting.  : Without basting  : 1 to 9 times	0 to 9	1	※3
S35	Basting pitch This item sets pitch at the time of performing basting. 	1.0 to 5.0	0.1mm	※3
S36	Rolling length of basting This item sets rolling length of needle thread when performing basting. 	2.0 to 20.0	0.1mm	※3
S37	Rolling pitch of basting This item sets rolling pitch of needle thread when performing basting. 	0.2 to 5.0	0.1mm	※3
S38	Rolling width of basting This item sets rolling width of needle thread when performing basting. 	0.0 to 4.0	0.1mm	※3
S39	Lengthwise compensation of needle entry of basting This item sets the amount to move needle entry position back and forth when performing basting more than two cycles. 	0.0 to 2.5	0.1mm	※2, ※3

No.	Item	Setting range	Edit unit	Remarks
S40	<p>Crosswise compensation of needle entry of basting</p> <p>This item sets the amount to move needle entry position to the right or left when performing basting more than two cycles.</p> 	0.1 to 1.0	0.1mm	※3
S41	<p>Compensation of left side position of basting</p> <p>This item sets the amount to move the sewing reference position of basting from the center of left overedging to the right or left.</p> 	-2.0 to 2.0	0.1mm	※2, ※3
S42	<p>Compensation of right side position of basting</p> <p>This item sets the amount to move the sewing reference position of basting from the center of right overedging to the right or left.</p> 	-2.0 to 2.0	0.1mm	※2, ※3
S44	<p>Speed setting of basting</p> <p>This item sets speed of basting.</p> 	400 to 4200	100rpm	※3

No.	Item	Setting range	Edit unit	Remarks
S51	Left parallel section tension This item sets needle thread tension at left parallel section.	0 to 200	1	---
S52	Right parallel section tension This item sets needle thread tension at right parallel section.	0 to 200	1	※2
S53	Left parallel section tension (1st cycle of double stitching) This item sets needle thread tension at left parallel section of 1st cycle at the time of double stitching.	0 to 200	1	※2, ※3
S54	Right parallel section tension (1st cycle of double stitching) This item sets needle thread tension at right parallel section of 1st cycle at the time of double stitching.	0 to 200	1	※2, ※3
S55	Tension at 1st bar-tacking section This item sets needle thread tension at 1st bar-tacking section.	0 to 200	1	---
S56	Tension at 2nd bar-tacking section This item sets needle thread tension at 2nd bar-tacking section.	0 to 200	1	※2
S57	Setting of needle thread tension at the start of sewing This item sets needle thread tension of tie stitching at the start of sewing.	0 to 200	1	---
S58	Setting of needle thread tension of basting This item sets needle thread tension of basting.	0 to 200	1	※3

No.	Item	Setting range	Edit unit	Remarks
S59	ACT timing adjustment at the start of 1st bar-tacking This item adjusts needle thread tension output start timing at 1st bar-tacking section. 	-5 to 5	1 stitch	※2
S60	ACT timing adjustment at the start of right overedging This item adjusts needle thread tension output start timing at right overedging section. 	-5 to 5	1 stitch	※2
S61	ACT timing adjustment at the start of 2nd bar-tacking This item adjusts needle thread tension output start timing at 2nd bar-tacking section. 	-5 to 5	1 stitch	※2
S62	Number of stitches of tie stitching at the start of sewing This item sets number of stitches of tie stitching at the start of sewing. 	0 to 8	1 stitch	---
S63	Sewing pitch of tie stitching at the start of sewing This item sets sewing pitch of tie stitching at the start of sewing. 	0.00 to 0.70	0.05mm	※2
S64	Tie stitching width at the start of sewing This item sets tie stitching width at the start of sewing. 	0.0 to 3.0	0.1mm	---
S65	Lengthwise compensation of tie stitching at the start of sewing This item sets start position of tie stitching in lengthwise direction at the start of sewing. 	0.0 to 5.0	0.1mm	※2
S66	Crosswise compensation of tie stitching at the start of sewing This item sets start position of tie stitching in crosswise direction at the start of sewing. 	0.0 to 2.0	0.1mm	※2

No.	Item	Setting range	Edit unit	Remarks
S67	Tie stitching width at the end of sewing This item sets tie stitching width at the end of sewing. 	0.1 to 1.5	0.1mm	---
S68	Number of stitches of tie stitching at the end of sewing This item sets number of stitches of tie stitching at the end of sewing. 	0 to 8	1 stitch	---
S69	Lengthwise compensation of tie stitching at the end of sewing This item sets start position of tie stitching in lengthwise direction at the end of sewing. 	0.0 to 5.0	0.1mm	*2
S70	Crosswise compensation of tie stitching at the end of sewing This item sets start position of tie stitching in crosswise direction at the end of sewing. 	0.0 to 2.0	0.1mm	*2
S81	Knife motion This item sets "With/without motion" of normal cloth cutting knife.  : Normal knife motion Off  : Normal knife motion ON	---	---	---
S83	Knife motion at 1st cycle of double stitching This item sets "With/without motion" of cloth cutting knife at 1st cycle when double stitching is performed.  : Normal knife motion Off  : Normal knife motion ON	---	---	*2, *3
S84	Maximum speed limitation This item sets max. number of revolutions of the sewing machine. The maximum value of data edit is equal to the number of revolutions of K07 Maximum speed limitation of the memory switch data. → Refer to 26-2 Memory switch data list, p.79 . 	400 to 4200	100rpm	---

No.	Item	Setting range	Edit unit	Remarks
S86	<p>Pitch of going</p> <p>This item sets sewing pitch of going side of bar-tacking shape (Shape Nos. 27, 28, 29 and 30 of S01).</p> 	0.200 to 2.500	0.025mm	---
S87	<p>Width of going</p> <p>This item sets width of going side of bar-tacking shape (Shape Nos. 27, 28, 29 and 30 of S01).</p> 	0.10 to 10.00	0.05mm	---
S88	<p>Pitch of returning</p> <p>This item sets sewing pitch of returning side of bar-tacking shape (Shape Nos. 27, 28, 29 and 30 of S01).</p> 	0.200 to 2.500	0.025mm	---
S89	<p>Width of returning</p> <p>This item sets width of returning side of bar-tacking shape (Shape Nos. 27, 28, 29 and 30 of S01).</p> 	0.10 to 10.00	0.05mm	---

16. SETTING PROCEDURE OF SEWING DATA WITH/WITHOUT EDIT

① Display the sewing data with/without edit setting screen.

When continuing pressing **M** switch for three seconds, the sewing data with/without edit setting button  (A) is displayed on the screen. When this button is pressed, the sewing data with/without edit setting screen is displayed.

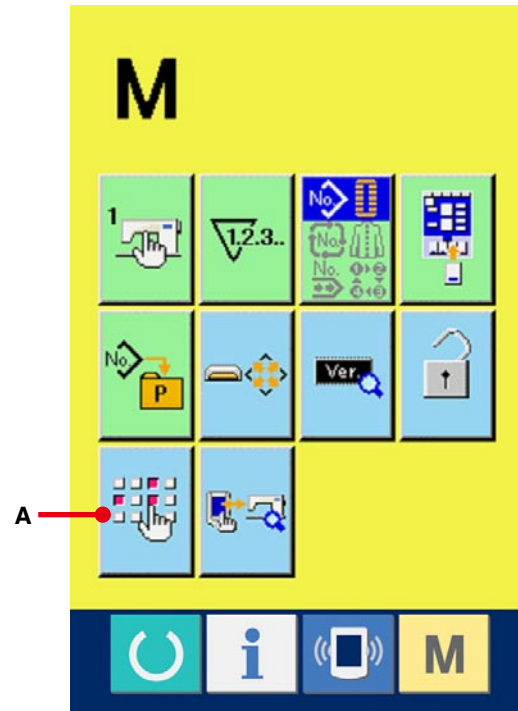

② Select the sewing data with/without edit.

The list of data item buttons (B) which are possible to set the data with/without edit among the sewing data is displayed. When the button is pressed, reverse display/normal display changes over alternately.

When you desire to set "With edit", set the reverse display. When you desire to set "Without edit", set the normal display.

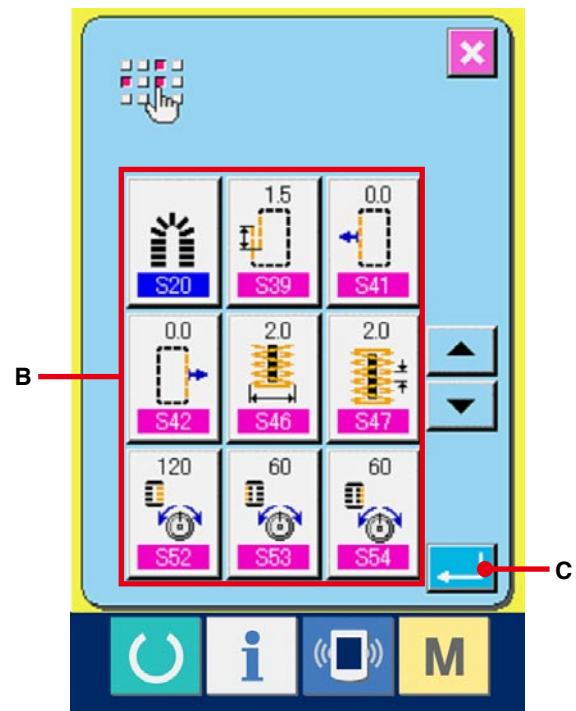

③ Determine the sewing data with/without edit.

When ENTER button  (C) is pressed, the state of with/without edit of the sewing data item which has been set is determined.

17. COPYING SEWING PATTERN

The sewing data of the pattern No. which has been already registered can be copied to the pattern No. which has not been registered. Overwriting copy of the pattern is prohibited. When you desire to overwrite, perform it after erasing the pattern once.

→ Refer to [6. PERFORMING PATTERN NO. SELECTION](#), p.20.

① Display the data input screen.

Only in case of the data input screen (blue), copying is possible. In case of the sewing screen (green), press READY switch  and display the data input screen (blue).

② Call the pattern copy screen.

When pattern copy button  (A) is pressed, the pattern copy (copy source selection) screen is displayed.

③ Select the pattern No. of copy source.

Select the pattern No. of copy source from the list of pattern buttons (B).

Then press copy destination input button 

(C) and the copy destination input screen is displayed.

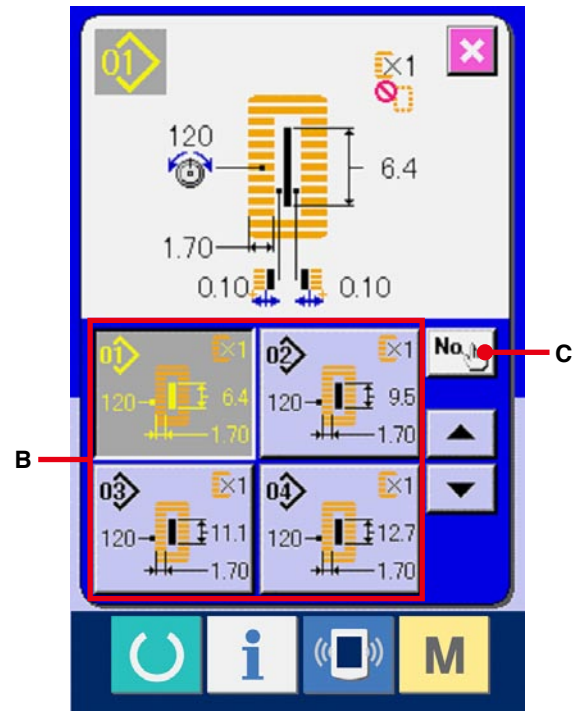
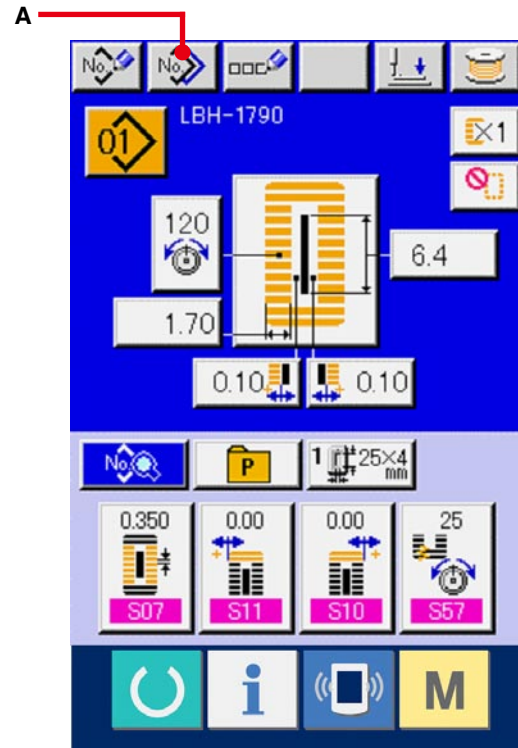

④ **Input the pattern No. of copy destination.**

Input the pattern No. of copy destination with ten keys (D). It is possible to retrieve the pattern No. which is not used with - and + buttons (E・F). (E・F).

⑤ **Start copying.**

Press ENTER button (G) and copying starts.

Pattern No. which has been copied in the selected state returns to the pattern copy (copy source selection) screen after approximately two seconds.

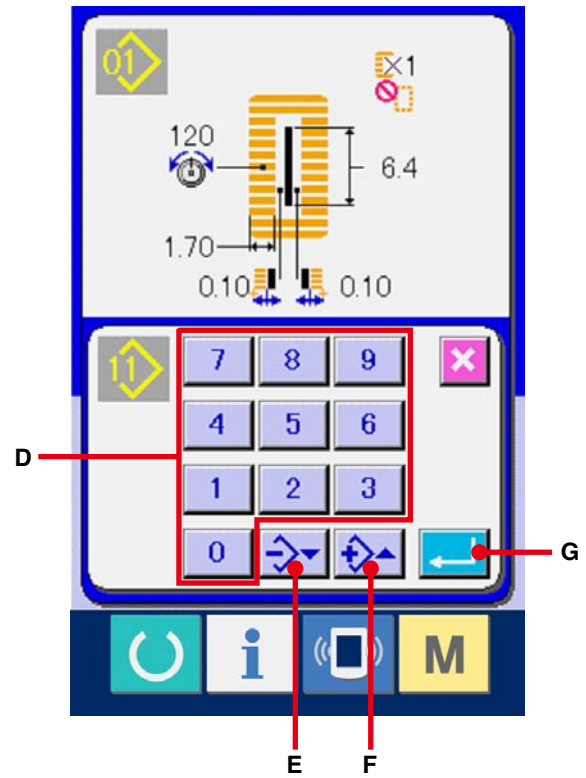

※1 Cycle data and continuous stitching data can be copied by the same method.

※2 When deletion is performed in case the remaining pattern No. which has been registered is one, pattern deletion error (Error code 402) is displayed.

※3 When trying to perform copying to the pattern No. which has been already registered, copy disapproval error (Error code 401) is displayed.

18. REGISTERING THE PATTERN TO DIRECT BUTTON

Register the pattern Nos. which are frequently used with the direct buttons for use.

Once the patterns are registered, the pattern selection can be performed with ease by pressing only the button.

18-1 How to register

① Display the direct pattern register screen.

When **M** switch is pressed, direct pattern register button  (A) is displayed on the screen.

When this button is pressed, the direct pattern register screen is displayed.

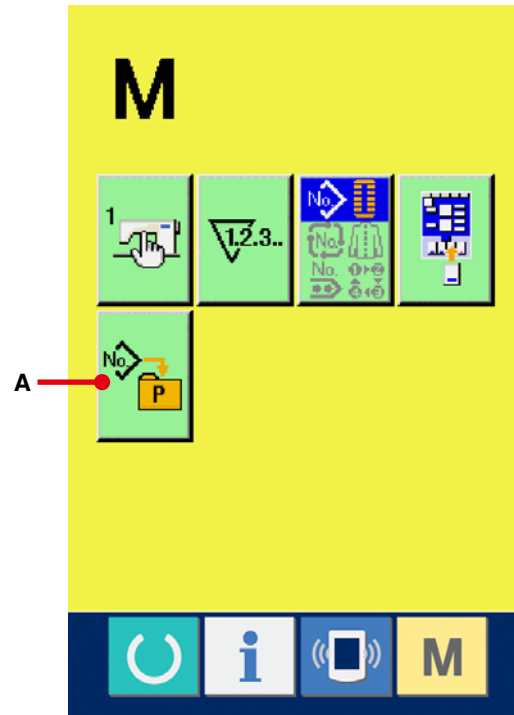

② Select the button to be registered.

Direct patterns can be registered up to 10 patterns.

10 direct buttons (B) are displayed on the screen.

When the button located on the position you desire to register is pressed, the pattern No. list screen is displayed.

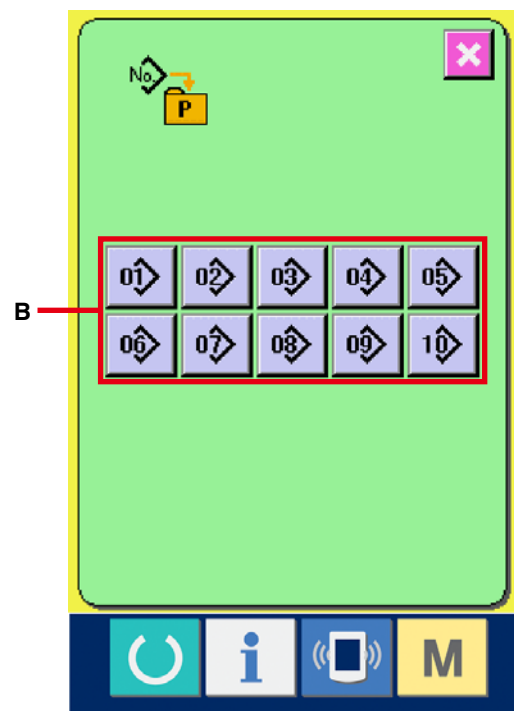

③ **Select the pattern No. to be registered.**

Select the pattern No. you desire to register from among pattern No. buttons (C). When the selected button is pressed twice, the selection is released.

④ **Register the direct pattern.**

When ENTER button  (D) is pressed, the register of direct pattern is finished and the direct pattern No. register screen is displayed.

The registered pattern No. is displayed on the direct button.

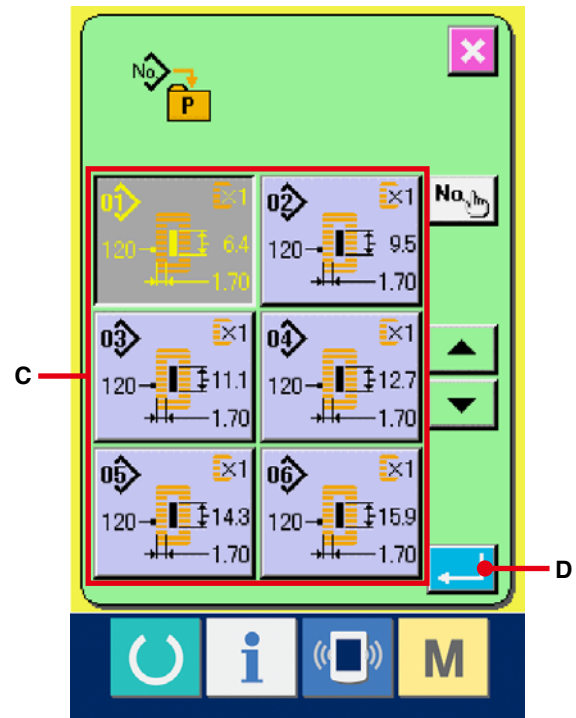

18-2 Register state at the time of your purchase

Pattern Nos. 1 to 10 have been registered at the time of your purchase.

19. REGISTERING SEWING DATA TO CUSTOMIZE BUTTON

Register parameters which are frequently used to CUSTOMIZE button and use them.

Screen of the change of parameters which have been registered can be displayed by pressing only CUSTOMIZE button in the data input screen.

19-1 How to register

① Display the customize pattern register screen.

When **M** switch is pressed, the customize

pattern register button  (A) is displayed on the screen.

When this button is pressed, the customize pattern register screen is displayed.

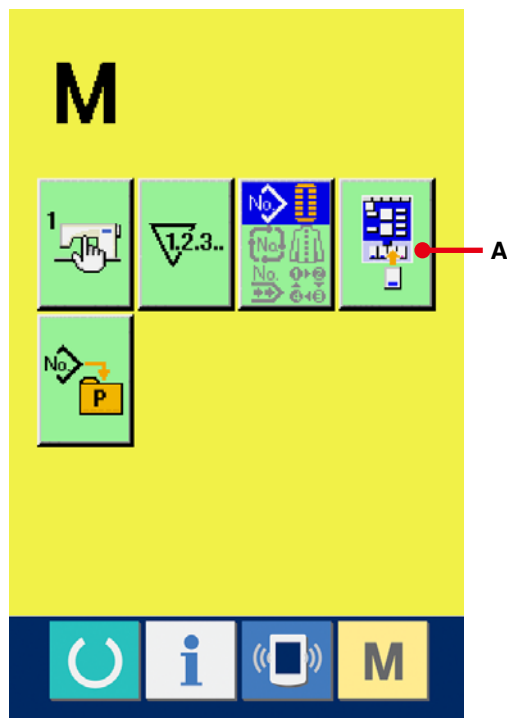

② Select the button to be registered.

The customize buttons can be registered up to four buttons. Four customize register buttons (B) are displayed on the screen. When the button located on the position you desire to register is pressed, the sewing data list screen is displayed.

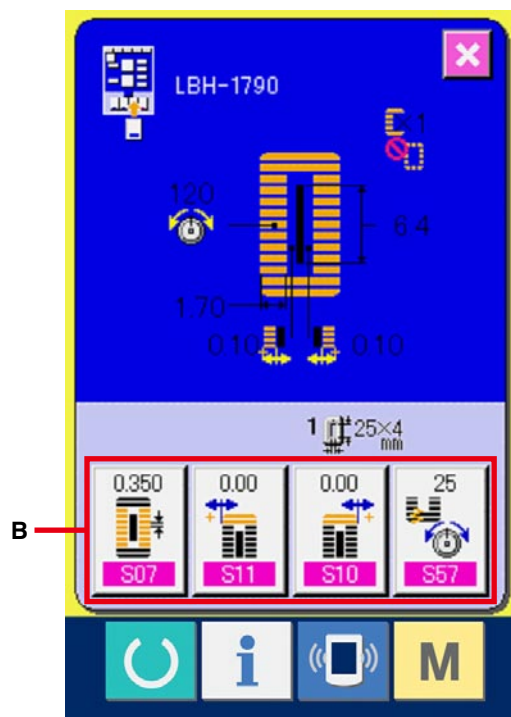

③ **Select the sewing data to be registered.**

Select the sewing data you desire to register with the sewing data buttons (C). When the selected button is pressed twice, the selection is released.



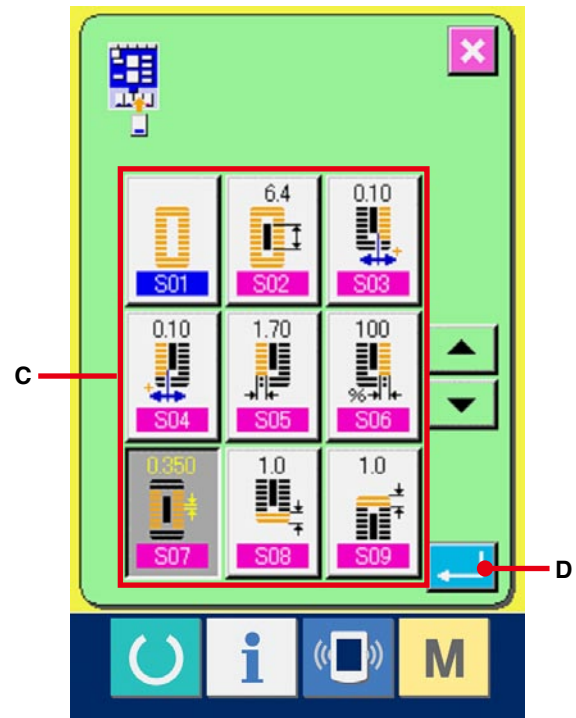

④ **Register to the customize button.**

When ENTER button  (D) is pressed, register to the customize button is finished and the customize button register screen is displayed. The registered sewing data is displayed on the customize button.



19-2 Register state at the time of your purchase

The following items have been registered in order at the time of your purchase.

-  **S07** Pitch at parallel section
-  **S11** Compensation of bar-tacking width, left
-  **S10** Compensation of bar-tacking width, right
-  **S57** Setting of needle thread tension at the start of sewing





20. CHANGING SEWING MODE

① Display the sewing mode selection screen.

When **M** switch is pressed, the sewing mode selection button  (A) is displayed on the screen. When this button is pressed, the sewing mode selection screen is displayed.

※ Image of the button of the sewing mode selection button changes according to the sewing mode which is selected at present.

When independent sewing is selected : 

When cycle stitching is selected : 

When continuous stitching is selected : 

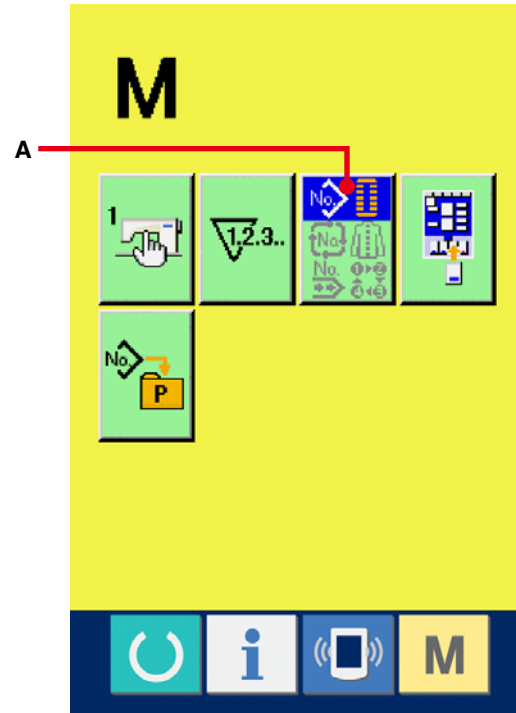

② Select the sewing mode.

Select the sewing mode you desire to sew.

Independent sewing button (B) : 

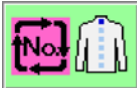
Cycle stitching button (C) : 

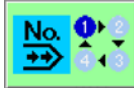
Continuous stitching button (D) : 

③ Determine the sewing mode.

When ENTER button  (E) is pressed, change of the sewing mode is finished. When **M** switch is pressed, the data input screen of the selected sewing mode is displayed.

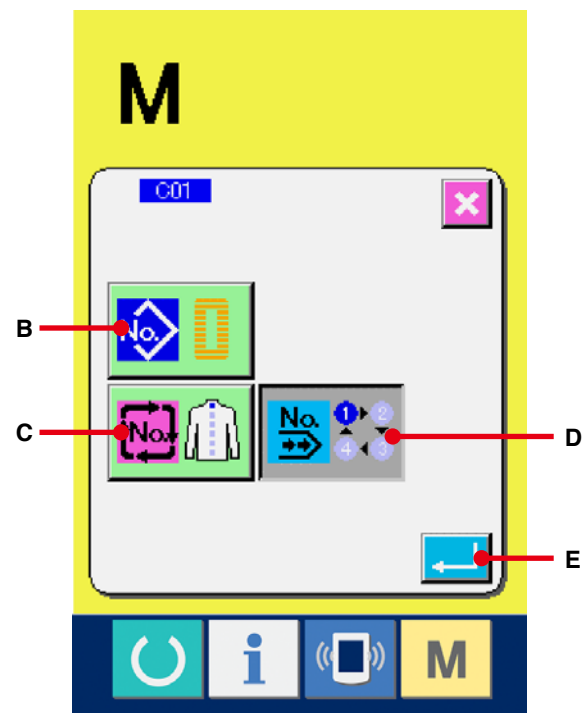

21. LCD DISPLAY SECTION AT THE TIME OF CONTINUOUS STITCHING

This sewing machine can perform the continuous stitching that continuously sew the plural sewing pattern data without lifting the presser.

It is possible to install a long presser of as long as 120 mm size and to automatically sew up to as many as 6 shapes in the presser.

In addition, it is possible to register as many as 20 data. Register or copy the data to fill the need for use.

→ Refer to [13. PERFORMING NEW REGISTRATION OF PATTERN, p.34](#) and [17. COPYING SEWING PATTERN, p.51](#).

※ It is necessary to change the components from the state at the time of your purchase according to the setting conditions.

21-1 Data input screen

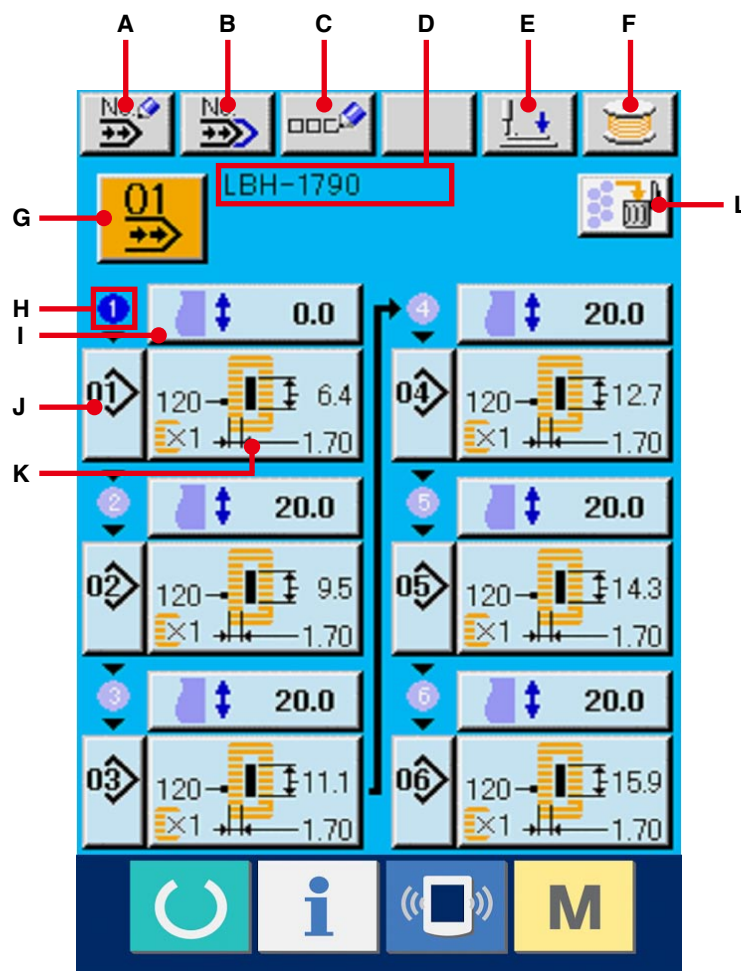

	Button and display	Description
A	CONTINUOUS STITCHING DATA NEW REGISTER button	Continuous stitching data new register screen is displayed.
B	CONTINUOUS STITCHING DATA COPY button	Continuous stitching data copy screen is displayed.
C	DATA NAME INPUT button	Continuous stitching data name input screen is displayed. → Refer to 7. NAMING THE PATTERN, p.22.
D	DATA NAME display	Name inputted in continuous stitching data No. which is being selected is displayed.
E	PRESSER DOWN button	Presser down screen is displayed and the needle moves to the right side. To raise the presser, press the presser up button displayed in the presser down screen. * When performing threading in this state, turn OFF the power before performing.
F	BOBBIN WINDER button	Bobbin thread can be wound. → Refer to 11. WINDING BOBBIN THREAD, p.29.
G	CONTINUOUS STITCHING DATA NO. SELECTION button	Continuous stitching data No. which is being selected at present is displayed in the button. When it is pressed, continuous stitching data No. selection screen is displayed.
H	SEWING ORDER	Sewing order of continuous stitching data which have been inputted is displayed.
I	FEED AMOUNT INPUT button	Cloth feed amount before sewing is displayed. When the button is pressed, feed amount input screen is displayed.
J	PATTERN NO. SELECTION button	Pattern No. which has been inputted is displayed. When the button is pressed, pattern No. list screen is displayed and pattern No. selection can be performed.
K	SEWING DATA EDIT button	Sewing data information such as pattern No., shape, cloth cutting length, etc. which have been inputted is displayed
L	ALL DELETE button	Contents inputted to continuous stitching data which is being selected are deleted.

* Number of patterns only to which buttons H to K and displays have been inputted is displayed.

21-2 Sewing screen

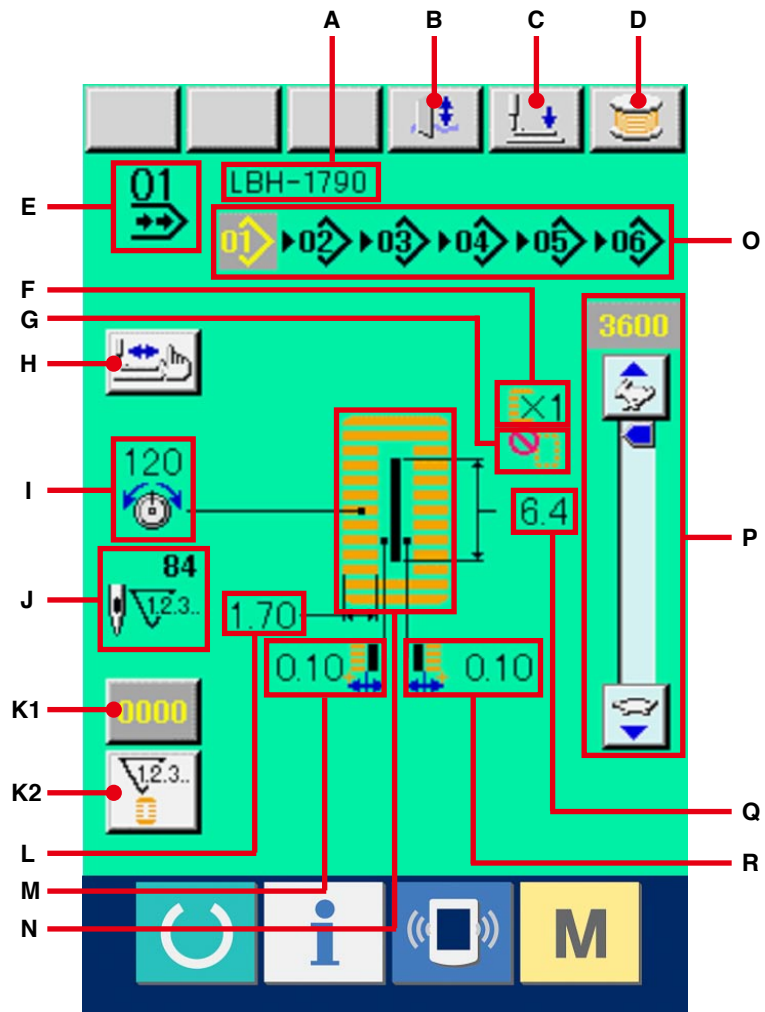

	Button and display	Description
A	CONTINUOUS STITCHING DATA NAME display	Name inputted to continuous stitching data during sewing is displayed.
B	KNIFE CANCEL button	Every time the button is pressed, dropping/non-dropping knife is changed over alternately.
C	PRESSER DOWN button	Presser can be lowered and the knife down screen is displayed. To raise the presser, press the presser up button displayed in the presser down screen. * When performing threading in this state, turn OFF the power before performing.
D	BOBBIN WINDER button	Bobbin thread can be wound. → Refer to 11. WINDING BOBBIN THREAD, p.29 .
E	CONTINUOUS STITCHING PATTERN NO. display	Continuous stitching data No. during sewing is displayed.
F	WITH/WITHOUT DOUBLE STITCHING display	With/without double stitching which is set to the pattern data during sewing is displayed.
G	NUMBER OF TIMES OF BASTING display	Number of times of basting which is set to the pattern data during sewing is displayed.
H	STEP STITCHING button	When the button is pressed, the step stitching screen to check the needle entry point and to perform re-sewing is displayed. → Refer to 10. PERFORMING RE-SEWING, p.27 .
I	NEEDLE THREAD TENSION CHANGE button display	Needle thread tension which is set to the pattern data during sewing is displayed.
J	NUMBER OF TOTAL STITCHES display	Number of total stitches of the continuous stitching data during sewing is displayed.
K1	COUNTER VALUE CHANGE button	Existing counter value is displayed on this button. When the button is pressed, the counter value change screen is displayed. → Refer to 12. USING COUNTER, p. 30 .
K2	COUNTER CHANGE OVER button	Display of sewing counter/No. of pcs. counter can be changed over. → Refer to 12. USING COUNTER, p. 30 .
L	OVEREDGING WIDTH, LEFT button	Overedging width, left which is set to the pattern data during sewing is displayed.
M	KNIFE GROOVE WIDTH, LEFT display	Knife groove width, left which is set to the pattern data during sewing is displayed.
N	SEWING SHAPE display	Sewing shape during sewing is displayed.

	Button and display	Description
O	PATTERN NO. display	Pattern No. inputted to continuous stitching data during sewing is displayed. Pattern NO. being sewn at present is displayed in reverse video.
P	SPEED variable resistor	Number of rotation of sewing machine can be changed. The number of rotation which is set is displayed.
Q	CLOTH CUTTING LENGTH display	Cloth cutting length which is set to the pattern data during sewing is displayed.
R	KNIFE GROOVE WIDTH, RIGHT display	Knife groove width, right which is set to the pattern data during sewing is displayed.

22. PERFORMING CONTINUOUS STITCHING

First, change the sewing mode to the continuous stitching before performing setting.

→ Refer to [20. CHANGING SEWING MODE, p.57](#).

22-1 Selection of the continuous stitching data

① Display the data input screen.

Only in case of the data input screen (light blue), it is possible to select continuous stitching data No. In case of the sewing screen (green), press READY  switch and display the data input screen (light blue).

② Call the continuous stitching data No. selection screen.

When continuous stitching data No. selection button  (A) is pressed, the continuous stitching data No. selection screen is displayed. Continuous stitching data No. selected at present and the contents are displayed in the upper part of the screen and other continuous stitching data No. buttons which have been registered are displayed in the lower part of the screen.

③ Select the continuous stitching data No.

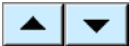
When UP/DOWN SCROLL button  is pressed, the registered continuous stitching data No. buttons change over in order. Contents registered to the continuous stitching data are displayed in the buttons. Here, press the continuous stitching data button (B) you desire to select.

④ Determine the continuous stitching data No.

When ENTER button  (C) is pressed, the continuous stitching data No. selection screen is closed and the selection has been finished.

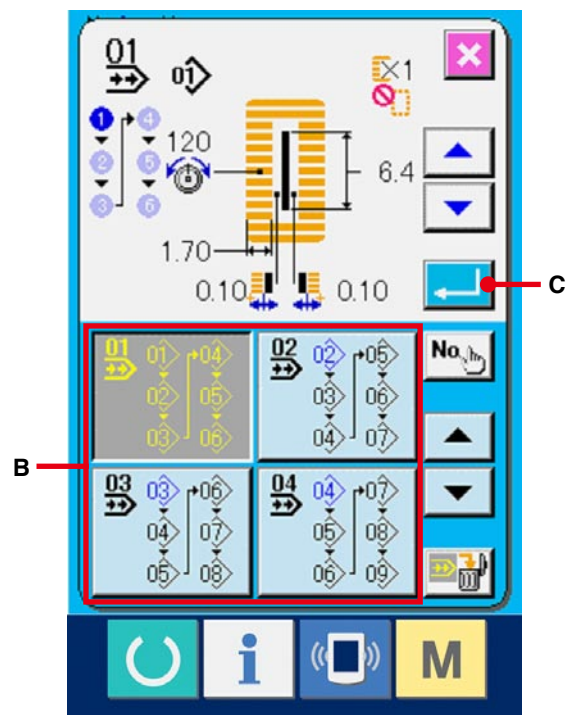
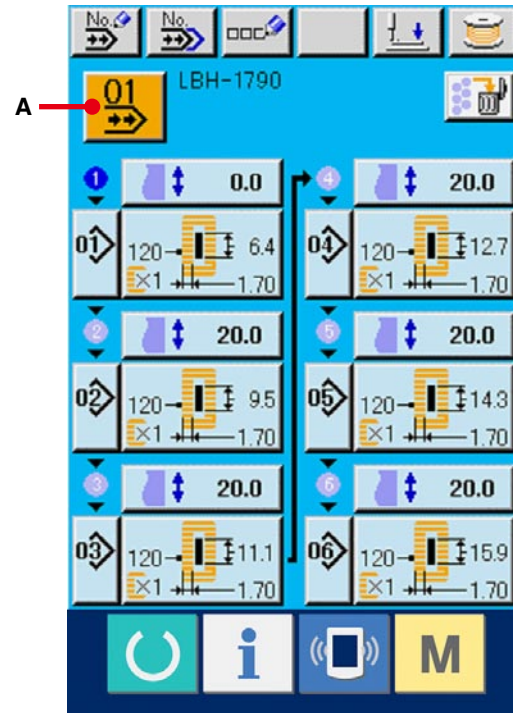

22-2 Editing procedure of the continuous stitching data

① Display the data input screen.

Only in case of the data input screen (light blue), it is possible to change the continuous stitching data. In case of the sewing screen (green), press READY switch  and display the data input screen (light blue).

After the screen is displayed, select the continuous stitching data No. you desire to edit referring to [22-1 Selection of the continuous stitching data, p.63](#). Continuous stitching data No. 1 only has been registered at the time of your purchase. However, pattern No. has not been inputted and the screen is displayed as shown in the figure on the right side.

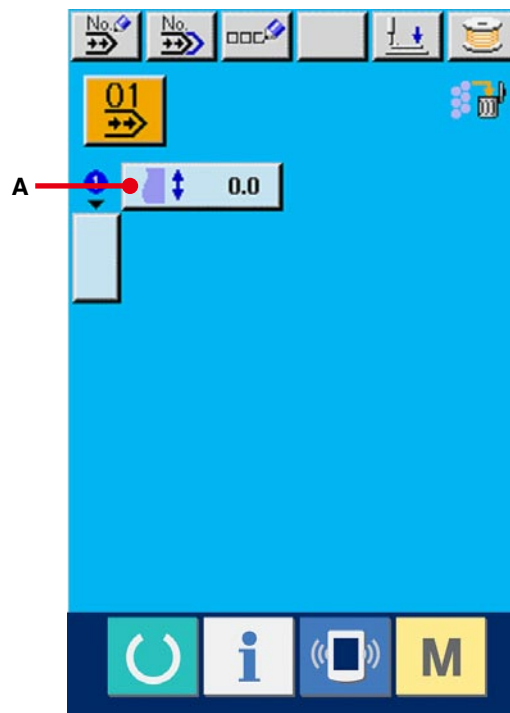

② Display the feed amount input screen.

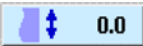
When FEED AMOUNT button  (A) is pressed, the feed amount input screen is displayed.

③ Input the feed amount.

Input the feed amount with plus/minus buttons



④ Determine the feed amount.

When ENTER button  (C) is pressed, the feed amount input screen is closed and input has been completed.

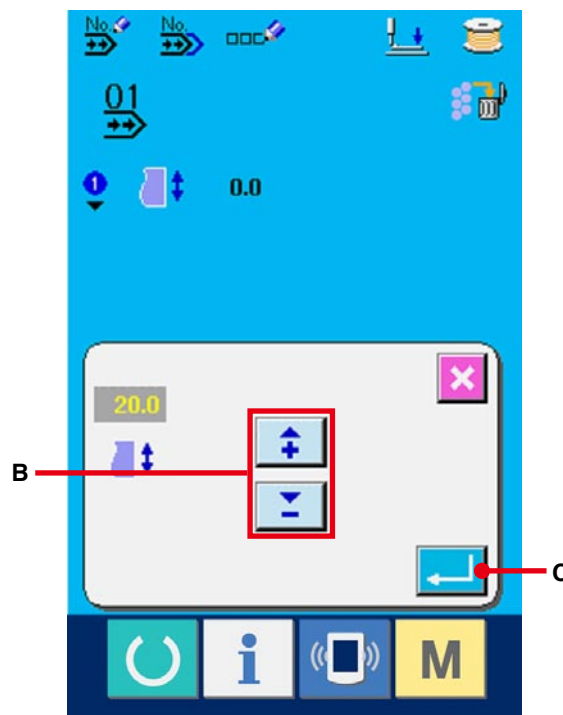

⑤ **Call the pattern No. selection screen.**

Press button  (D) displayed under the sewing order display. Pattern No. to sew first selection screen is displayed.

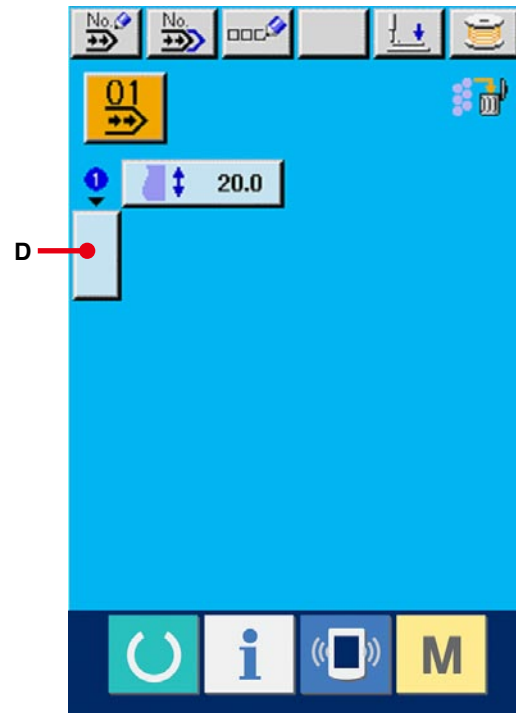

⑥ **Select the pattern No.**

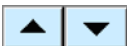
When UP/DOWN SCROLL button  is pressed, the registered pattern No. buttons (E) change over in order. Contents of sewing data are displayed in the buttons. Here, press the pattern No. button you desire to select.

⑦ **Determine the pattern No.**

When ENTER button  (F) is pressed, the continuous stitching data No. selection screen is closed and the selection has been completed.

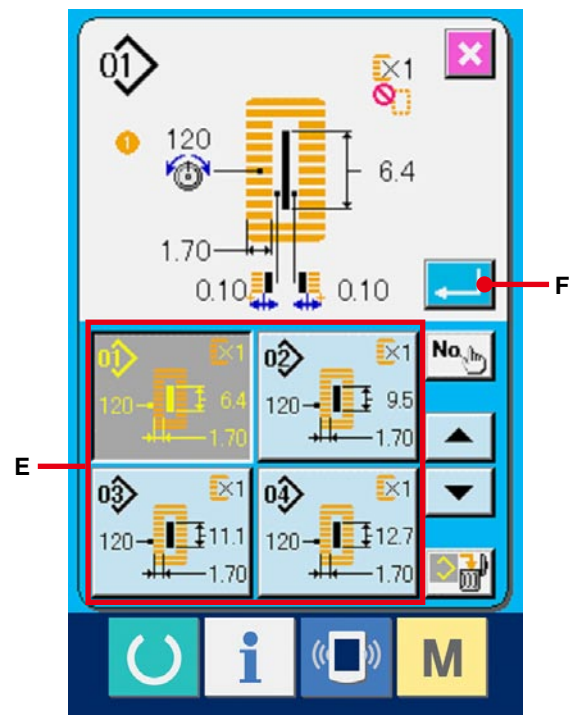

⑧ **Edit the sewing data of pattern inputted to continuous stitching data.**

When the pattern No. is selected, the sewing data button  (G) displayed the contents of the sewing data inputted to the selected pattern No. is displayed. When the button is pressed, the sewing data input screen is displayed.

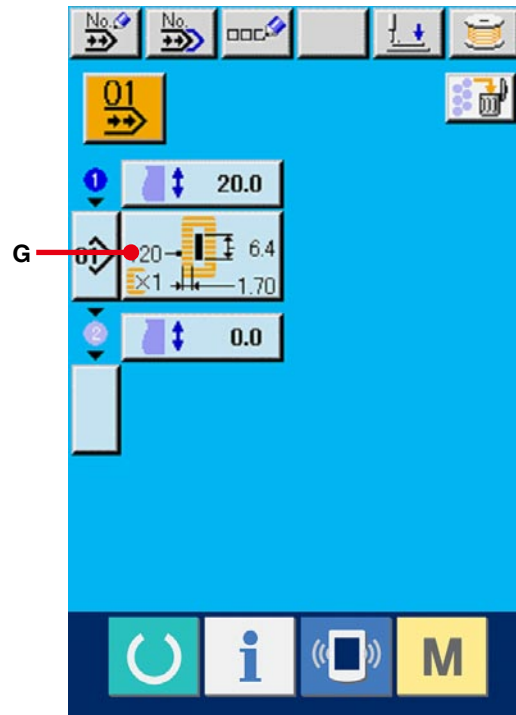

⑨ **Select the sewing data to be changed.**

Press UP/DOWN SCROOLI button  (H) and select the data item button (I) you desire to change. Data items which are not used according to the shapes and those which have been set to "Without function" are not displayed. So, be careful.

⑩ **Change the data.**

There are data items to change numerals and those to select pictographs in the sewing data. No. in pink color such as **S02** is put on the data items to change numerals and the set value can be changed with +/- button displayed in the change screen. No. in blue color such as **S20** is put on the data items to select pictographs and the pictographs displayed in the change screen can be selected. For the details of the sewing data, refer to [15-3 Sewing data list, p.40](#). Repeat steps ② through ⑩ and edit the data.

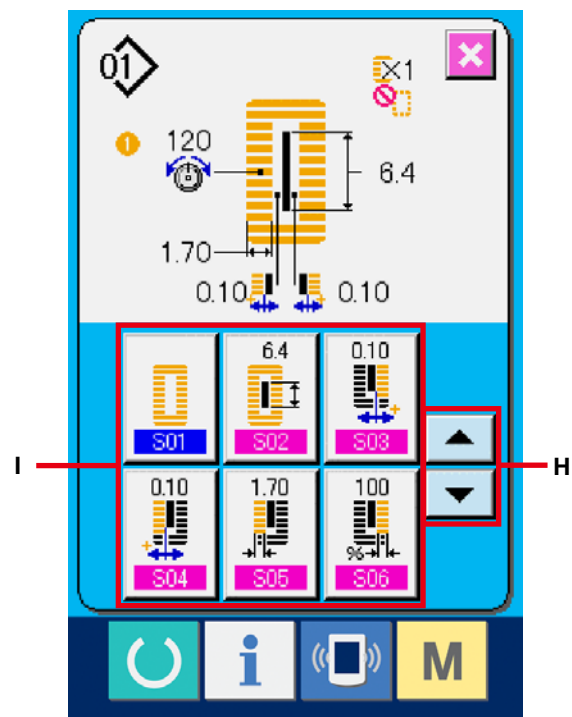

※ Now, input has been completed. However, for the continuous stitching, enter all data within the range of the presser size. When the data is outside the range, error is displayed. Be sure to correctly input the presser size.

→ Refer to [5. INPUTTING PRESSER TYPE, p.18](#).

23. LCD DISPLAY SECTION AT THE TIME OF CYCLE STITCHING

This sewing machine can sew the plural sewing pattern data in order in cycle.

As many as 30 patterns can be inputted. Use this function when sewing plural different button holes on the sewing product. In addition, as many as 20 cycles can be registered. Use this function for new creation or copying in case of need.

→ Refer to [13. PERFORMING NEW REGISTRATION OF PATTERN, p.34](#) and [17. COPYING SEWING PATTERN, p.51](#).

23-1 Data input screen

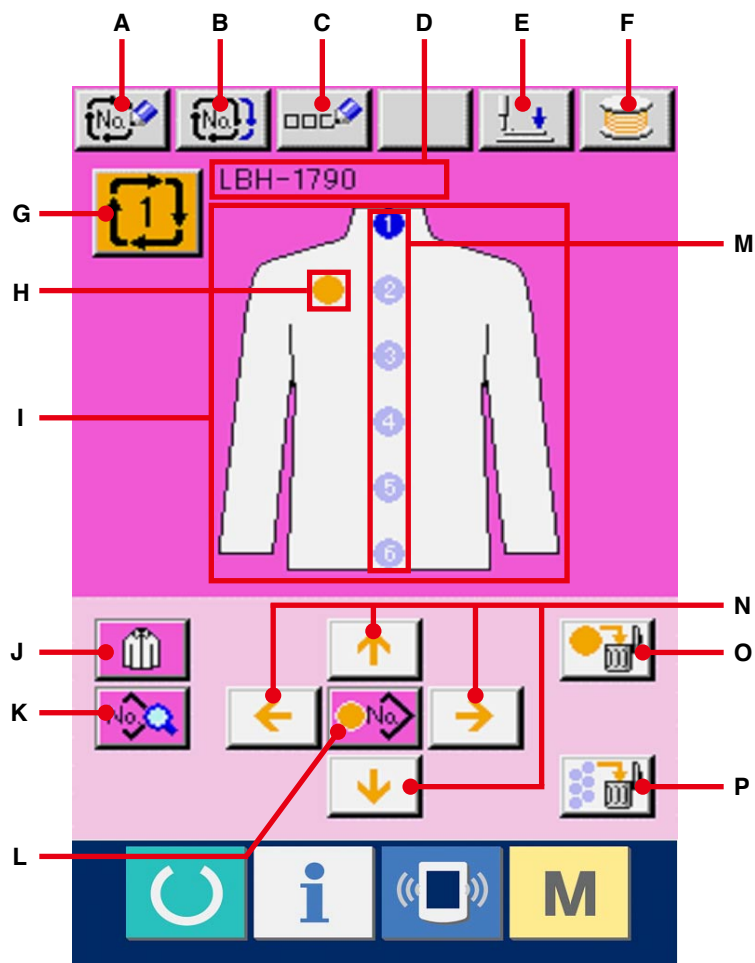

	Button and display	Description
A	CYCLE DATA NEW REGISTER button	Cycle data No. new register screen is displayed.
B	CYCLE DATA COPY button	Cycle pattern No. copy screen is displayed.
C	CYCLE DATA NAME INPUT button	Cycle data name input screen is displayed. → Refer to 7. NAMING THE PATTERN, p.22.
D	CYCLE DATA NAME display	Name inputted in cycle data which is being selected is displayed.
E	PRESSER DOWN button	Presser down screen is displayed and the needle moves to the right side. To raise the presser, press the presser up button displayed in the presser down screen. * When performing threading in this state, turn OFF the power before performing.
F	BOBBIN WINDER	Bobbin thread can be wound. → Refer to 11. WINDING BOBBIN THREAD, p.29.
G	CYCLE DATA NO. SELECTION button	Cycle data No. which is being selected is displayed in the button. When the button is pressed, cycle data No. change screen is displayed.
H	CURSOR display	Cursor can move on sewing product with ARROW MARK button (N) and can designate the position on sewing product to input pattern data.
I	SEWING PRODUCT display	Image of sewing product is displayed.
J	SEWING PRODUCT SELECTION button	Image of sewing product (I) selection screen is displayed.
K	SEWING DATA CHANGE button	Sewing data of pattern data inputted in the position of cursor change screen is displayed.
L	PATTERN SELECTION button	When the button is pressed, pattern No. change screen is displayed. In addition, pattern No. can be inputted in the position of cursor.
M	SEWING ORDER display	Sewing order of inputted pattern data is displayed. When the screen is changed over to the sewing screen, pattern to be sewn first is displayed in blue color.
N	ARROW MARK button	Position of cursor (H) can be moved.
O	PATTERN SEPARATE DELETE button	Release of input of pattern data registered in the position of cursor can be performed.
P	PATTERN ALL DELETE button	Release of input of all pattern data inputted in cycle data which is being selected can be performed.

23-2 Sewing screen

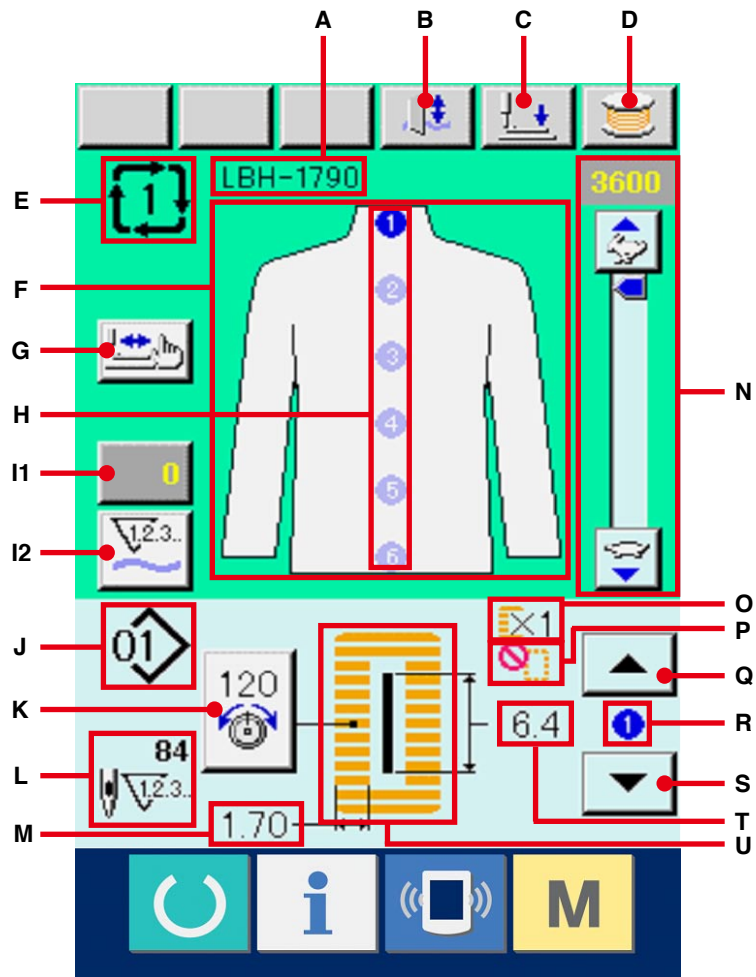

	Button and display	Description
A	CYCLE DATA NAME display	Name inputted in cycle data during sewing is displayed.
B	KNIFE CANCEL button	Every time the button is pressed, dropping/non-dropping knife is changed over alternately.
C	PRESSER DOWN button	Presser can be lowered and the knife down screen is displayed. To raise the presser, press the presser up button displayed in the presser down screen. * When performing threading in this state, turn OFF the power before performing.
D	BOBBIN WINDER button	Bobbin thread can be wound. → Refer to 11. WINDING BOBBIN THREAD, p.29.
E	CYCLE DATA NO. display	Cycle data No. during sewing is displayed.
F	SEWING PRODUCT display	Image of sewing product is displayed.
G	STEP STITCHING button	When the button is pressed, the step stitching screen to check the needle entry point and to perform re-sewing is displayed. → Refer to 10. PERFORMING RE-SEWING, p.27.
H	SEWUNG ORDER display	Sewing order of inputted pattern data is displayed. Pattern data during sewing is displayed in blue color.
I1	COUNTER VALUE CHANGE button	Existing counter value is displayed on this button. When the button is pressed, the counter value change screen is displayed. → Refer to 12. USING COUNTER, p. 30.
I2	COUNTER CHANGE OVER button	Display of sewing counter/No. of pcs. counter can be changed over. → Refer to 12. USING COUNTER, p. 30.
J	PATTERN NO. display	Pattern No. during sewing is displayed.
K	NEEDLE THREAD TENSION CHANGE button	Needle thread tension inputted in the pattern data during sewing is displayed. When the button is pressed, the needle thread tension change screen is displayed.
L	NUMBER OF TOTAL STITCHES display	Number of total stitches of the pattern data during sewing is displayed.
M	OVEREDGING WIDTH, LEFT display	Overedging width, left which is set to the pattern data during sewing is displayed.
N	SPEED variable resistor	Number of rotation of the sewing machine can be changed.
O	WITH/WITHOUT DOUBLE STITCHING display	With/without double stitching which is set to the pattern data during sewing is displayed.
P	NUMBER OF TIMES OF DOUBLE STITCHING display	Number of times of basting which is set to the pattern data during sewing is displayed.

	Button and display	Description
Q	SEWING ORDER RETURN button	Sewing order to be sewn next is returned by one.
R	SEWING ORDER DURING SEWING display	Sewing order of pattern data during sewing is displayed.
S	SEWING ORDER ADVANCE button	Sewing order to be sewn next is advanced by one.
T	CLOTH CUTTING LENGTH display	Cloth cutting length which is set to the pattern data during sewing is displayed.
U	SEWING SHAPE display	Sewing shape of the pattern data during sewing is displayed.

24. PERFORMING CYCLE STITCHING

First, change the sewing mode to the cycle stitching before performing setting.

→ Refer to [20. CHANGING SEWING MODE, p.57.](#)

24-1 Selection of the cycle data

① Selection of the cycle data

Display the data input screen.

Only in case of the data input screen (pink), it is possible to select the cycle data No. In case of the sewing screen (green), press READY switch



and display the data input screen (pink).

② Call the cycle data No. selection screen.

When cycle data No. button (A) is pressed, the cycle data selection screen is displayed.

Cycle data No. which is selected at present and the contents are displayed in the upper part of the screen and other cycle data No. buttons which have been registered are displayed in the lower part of the screen.

③ Select the cycle data No.

When UP/DOWN button is pressed, the registered cycle data No. buttons (B) are changed over in order. Contents of cycle data are displayed in the buttons. Here, press the cycle data button (B) you desire to select.

④ Determine the cycle data No.

When ENTER button (C) is pressed, the cycle data No. selection screen is closed and the selection has been completed.

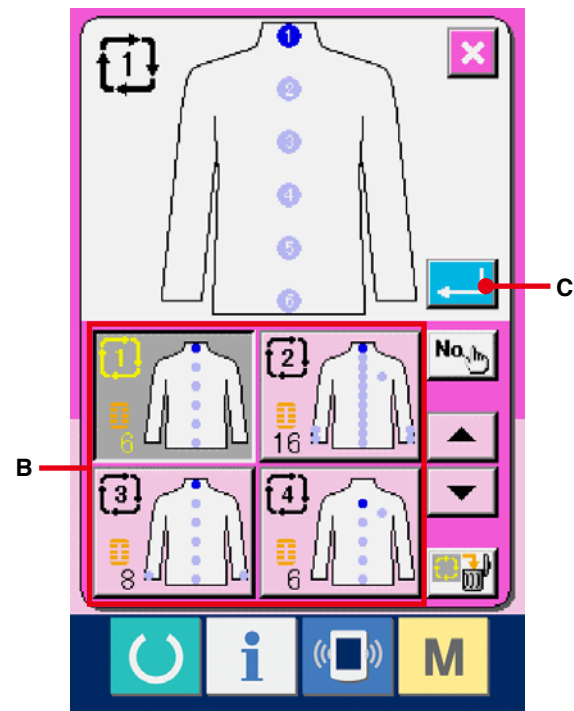

24-2 Editing procedure of the cycle data

① Display the data input screen.

Only in case of the data input screen (pink), it is possible to input the cycle data. In case of the sewing screen (green), press READY switch  and display the data input screen (pink).

② Move the cursor to the position you desire.

Move cursor (B) to the position you desire with arrow mark button (A), press pattern No. selection button (C), and call the pattern No. selection screen.

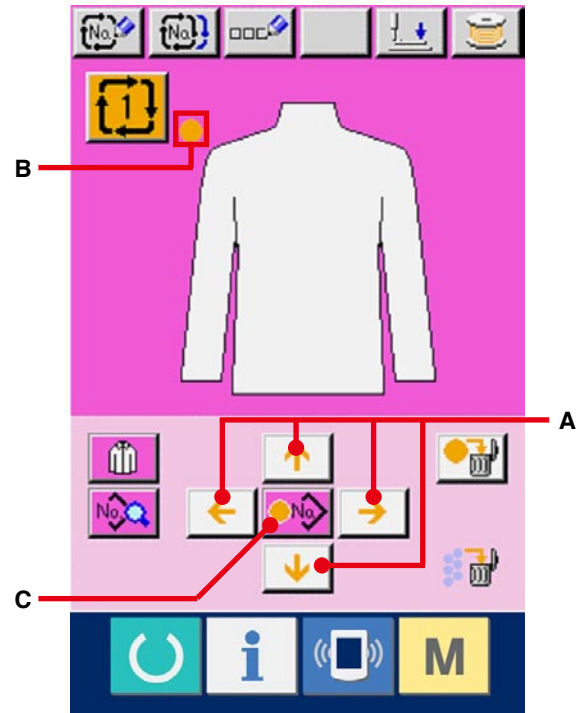

③ Select the pattern No.

When UP/DOWN SCROLL button  (D) is pressed, the registered pattern No. buttons (E) are changed over in order. Contents of the pattern data are displayed in the buttons. Here, press the pattern No. button you desire to select.

④ Determine the pattern No.

When ENTER button  (F) is pressed, the pattern No. selection screen is closed and the selection has been completed.

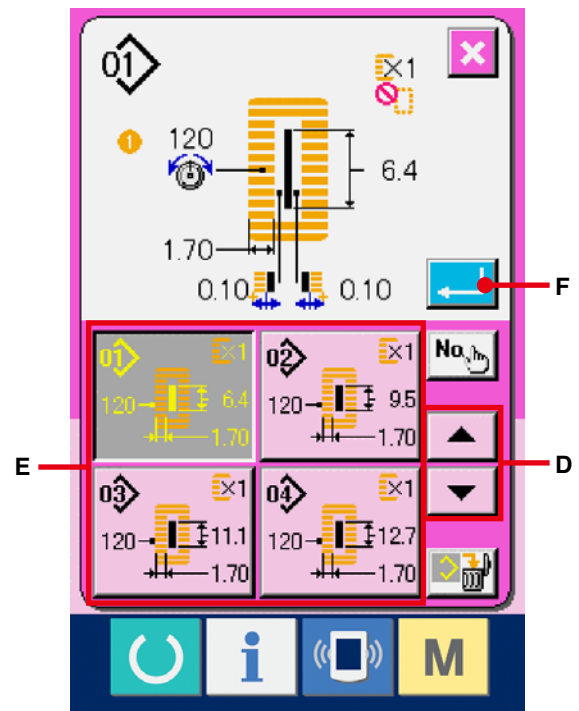

⑤ **Edit the sewing data of pattern inputted in cycle data.**

When the pattern data is inputted in the designated position, the inputted order is displayed on the screen as the sewing order.

Adjust the cursor to the position where the sewing order is displayed and press sewing data button  (G). Then sewing data input screen is displayed.

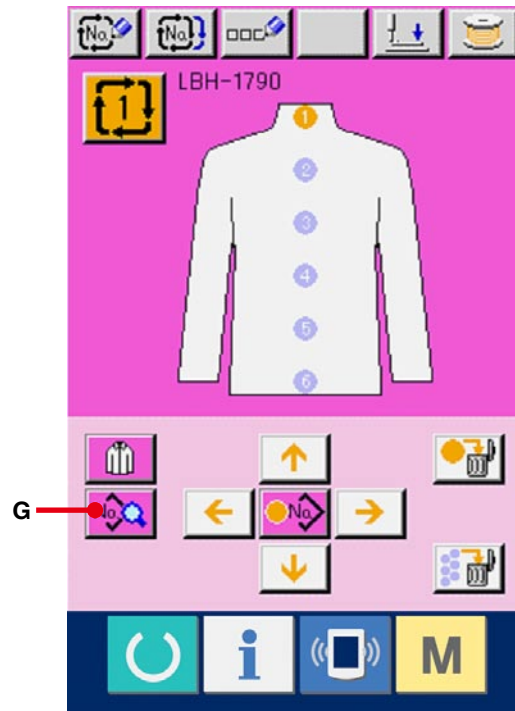

⑥ **Select the sewing data to be changed.**

Press scroll UP/DOWN button  (H) and select the data item button (I) you desire to change. Data items which are not used according to the shape and data items which have been set to Without function are not displayed. So, be careful.

⑦ **Change the data.**

There are data items to change numerals and those to select pictographs in the sewing data. No. in pink color such as **S02** is put on the data items to change numerals and the set value can be changed with buttons displayed in the change screen. No. in blue color such as **S20** is put on the data items to select pictographs and the pictographs displayed in the change screen can be selected.

→ For the details of sewing data, refer to [15-3 Sewing data list, p.40](#).

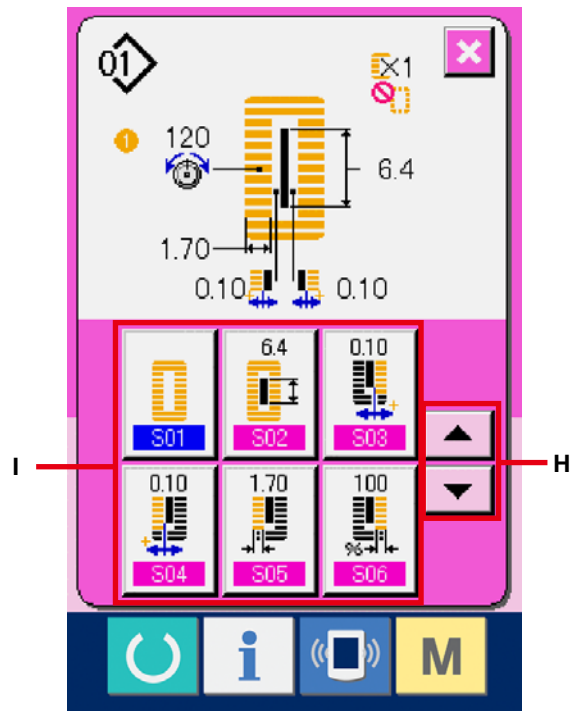

25. PERFORMING CHANGE OF DISPLAY OF SEWING PRODUCT

The picture displayed in the center of the screen can be changed.

① Display the data input screen.

Only in case of the data input screen (pink), it is possible to change the sewing product. In case of the sewing screen (green), press READY switch

 and display the data input screen.

② Call the sewing product selection screen.

When the sewing product selection button 

(A) is pressed, the sewing product selection screen is displayed.

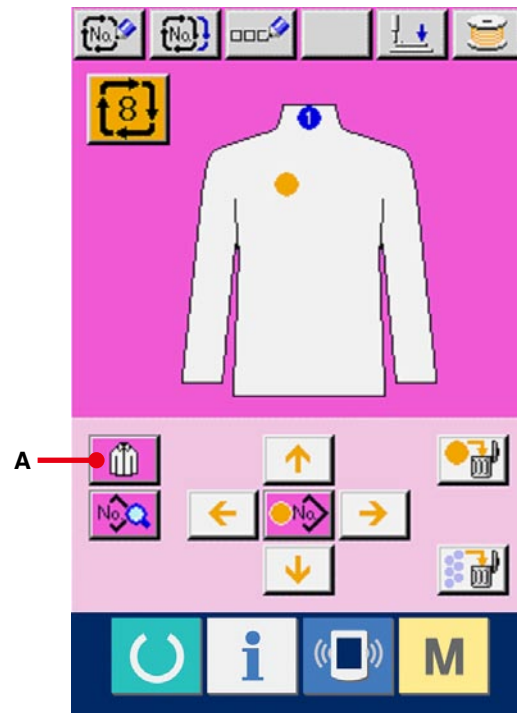

③ Select the image of sewing product to be displayed.

Select the sewing product button (B) you desire to display.

④ Determine the image of the sewing product to be displayed.

When ENTER button  (C) is pressed, the selection is determined and the data input screen is displayed.

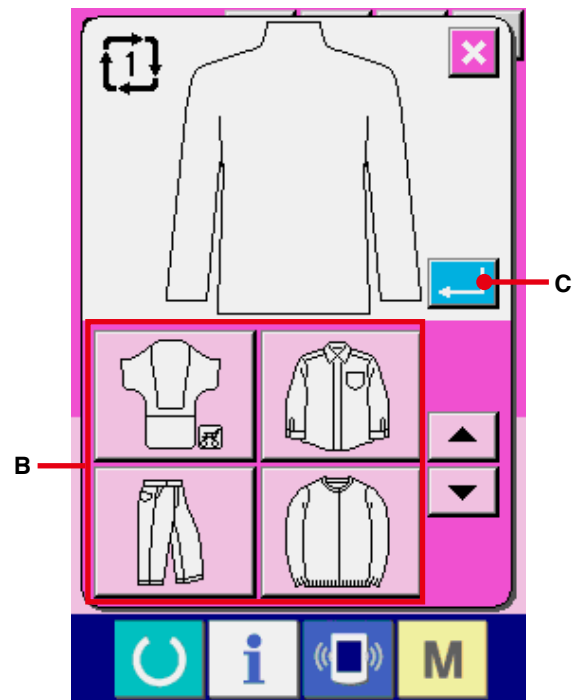

⑤ **Image of the selected sewing product is displayed.**

The image of selected sewing product is displayed in the data input screen. Position and number of pieces in which pattern data is inputted are not changed to those before the change of image of sewing product.

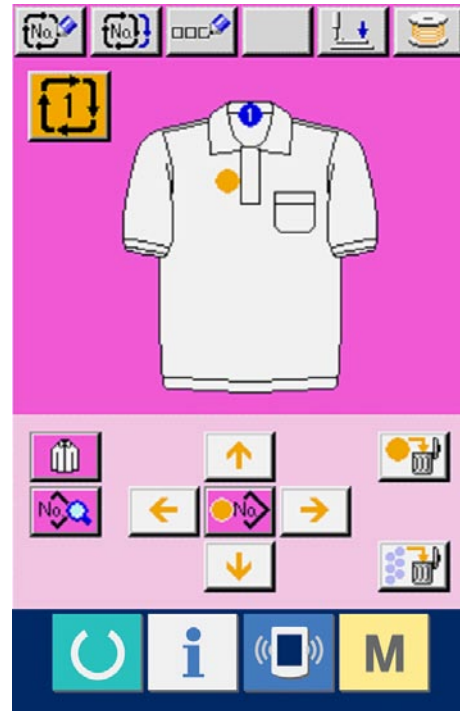

26. CHANGING MEMORY SWITCH DATA

26-1 Changing procedure of memory switch data

① **Display the memory switch data list screen.**

When **M** switch is pressed, memory switch button  (A) is displayed on the screen. When this button is pressed, the memory switch data list screen is displayed.

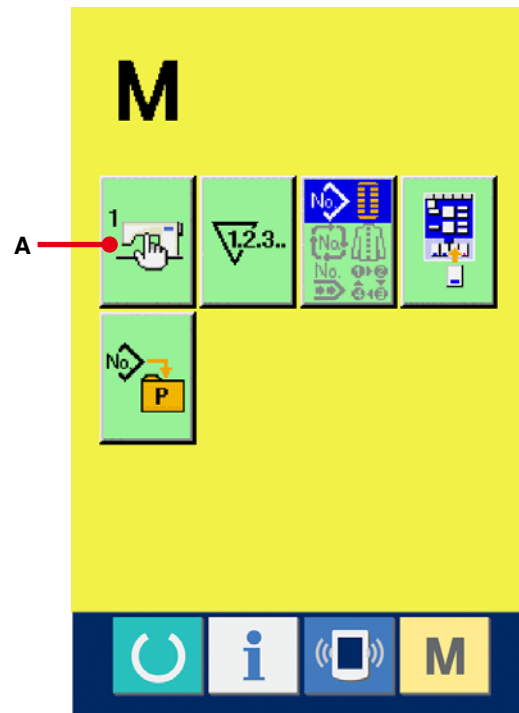

② **Select the memory switch button you desire to change.**

Press UP/DOWN SCROLL button  (B) and select the data item button (C) you desire to change.

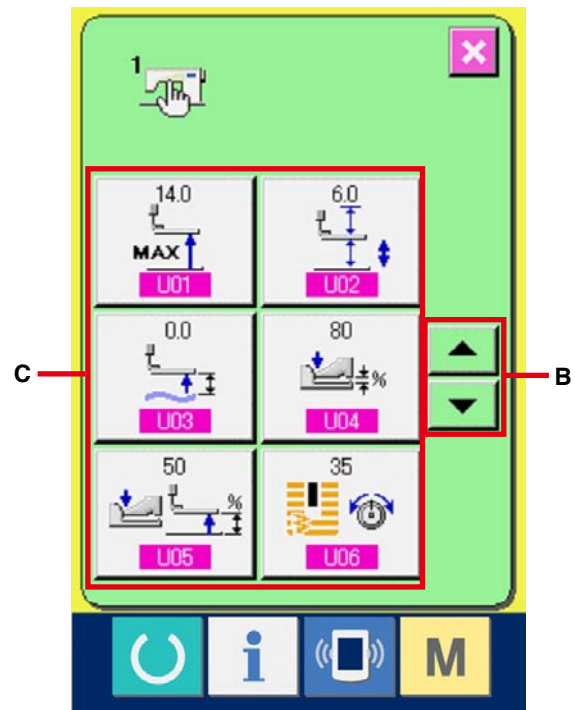

③ **Change the memory switch data.**

There are data items to change numerals and those to select pictographs in the memory switch data. No. in pink color such as **U01** is put on the data items to change numerals and the set value can be changed with buttons displayed in the change screen. No. in blue color such as **U19** is put on the data items to select pictographs and the pictographs displayed in the change screen can be selected.

→ For the details of memory switch data, refer to [26-2 Memory switch data list, p.79.](#)

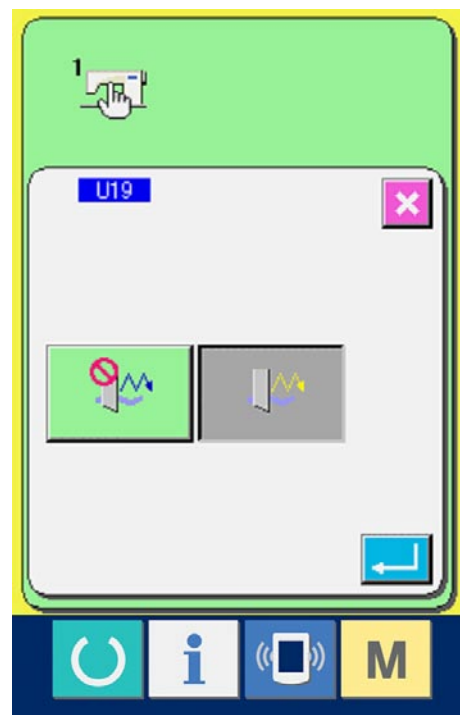
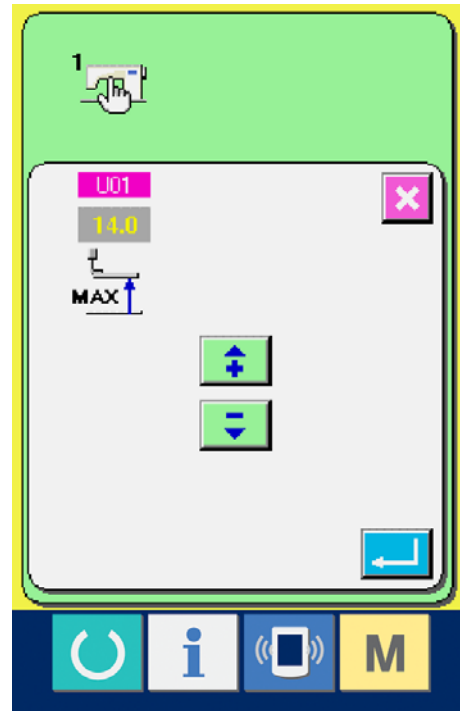







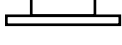







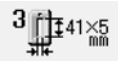



26-2 Memory switch data list

① Level 1

Memory switch data (level 1) are the motion data that the sewing machine has in common and the data that operate on all sewing patterns in common.

	Item	Setting range	Edit unit	Initial display
U01	Presser lifter maximum position Height of maximum position of pedal operation is set.	0 to 17.0	0.1mm	14.0mm
U02	Presser lifter intermediate position Height of intermediate position of pedal operation is set.	0 to 14.0	0.1mm	6.0mm
U03	Presser lifter cloth setting position Height of cloth setting position of pedal operation is set.	0 to 14.0	0.1mm	0.0mm
U04	Pedal toe down position of 2-pedal (%) Operation feeling at the time of 2-pedal is set. For the details, refer to the item below.	5 to 95	1%	80%
U05	Lifting position of presser foot of 2-pedal Operation feeling at the time of 2-pedal is set. <div style="display: flex; justify-content: space-around; align-items: center;"> <div style="text-align: center;"> <p>Pedal toe down amount</p>  <p>U04 Pedal toe down position of 2-pedal(%)</p> </div> <div style="text-align: center;"> <p>Presser lifting amount</p>  <p>U05 Lifting position of presser foot of 2-pedal (%)</p> </div> </div>	5 to 95	1%	50%
U06	Needle thread tension at sewing end setting	0 to 200	1	50
U07	Needle thread tension at thread trimming	0 to 200	1	35
U08	Needle thread tension of basting for sewing together setting	0 to 200	1	60





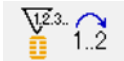





	Item	Setting range	Edit unit	Initial display
U09	Soft-start speed setting 1st stitch 	400 to 4200	100rpm	800rpm
U10	Soft-start speed setting 2st stitch 	400 to 4200	100rpm	800rpm
U11	Soft-start speed setting 3st stitch 	400 to 4200	100rpm	2000rpm
U12	Soft-start speed setting 4st stitch 	5 to 95	100rpm	3000rpm
U13	Soft-start speed setting 5st stitch 	5 to 95	100rpm	4000rpm
U14	Kind of presser Set the kind of the presser. Refer to 5. INPUTTING THE PRESSER TYPE.P.18    	---	---	Type 1
U15	Presser size width (Type 5) When type 5 of U14 Kind of presser is set, input the width of the presser. 	3.0 to 10.0	0.1mm	3.0mm

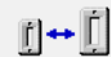









	Item	Setting range	Edit unit	Initial display
U16	Presser size length (Type 5) When type 5 of U14 Kind of presser is set, input the length of the presser. 	10.0 to 120.0	0.5mm	10.0mm
U17	Sewing start position (Feed direction) Sewing start position in terms of presser is set. Set this item when starting position is desired to be shifted due to overlapped section or the like. 	2.5 to 110.0	0.1mm	2.5mm
U18	Cloth cutting knife size Input knife size used. 	3.0 to 32.0	0.1mm	32.0mm
U19	Function of plural motions of cloth cutting knife Ineffective/effective  : Ineffective  : Effective	---	---	Ineffective
U20	Function of thread breakage detection Ineffective/effective  : Ineffective  : Effective	---	---	Effective
U21	Selection of presser position at the time of ON of READY key (Up/Down) Presser foot position when READY key is pressed is set.  : Presser up  : Presser down	---	---	Presser UP
U22	Selection of presser position at the time of completion of 1-cycle (Up/Down) Presser foot position when 1-cycle is completed is set.  : Presser up  : Presser down	---	---	Presser UP
U23	Needle thread trimming release motion start distance Distance from start of sewing to start of trimmer release motion of needle thread trimmer motor is inputted. 	0 to 15.0	0.1mm	1.0mm







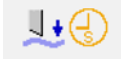

	Item	Setting range	Edit unit	Initial display
U24	Bobbin thread trimming release motion start distance Distance from start of sewing to start of trimmer release motion of bobbin thread trimmer motor is inputted. 	0 to 15.0	0.1mm	1.5mm
U25	Counter updating unit Unit to update sewing counter is set. 	1 to 30	1	1

② Level 2

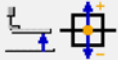
Memory switch data (level 2) can be edited when pressing MODE switch for as long as 6 seconds.

	Item	Setting range	Edit unit	Initial display
K01	<p>Pedal selection Pedal type is set. → 4. HOW TO USE THE PEDAL, p.15.</p>  : 2-pedal  : 1-pedal (Without intermediate position)  : 1-pedal (With intermediate position)	---	---	2-pedal
K03	<p>Function of prohibition of selection of kind of presser Permitted/Prohibited Prohibition of change of U14 Kind of presser is set.</p>  : Change permitted  : Change prohibited	---	---	Change permitted
K04	<p>Selection of machine type Type of sewing machine head is set.</p>  : 12 shapes  : 20 shapes  : 30 shapes	---	---	12 shapes
K05	<p>Cloth cutting knife power Output power of cloth cutting knife is set.</p> 0 : Min. power → 3 : Max. power 	0 to 3	1	1
K06	<p>Selection of machine type Type of sewing machine head is set.</p> 0 : Standard type  1 : Dry head type	0 to 1	1	0 (Standard type)
K07	<p>Max. speed limitation speed setting Max. speed of sewing machine can be limited. When K06 Selection of machine type is set to dry head type, max. speed is automatically limited to 3,300 rpm.</p> 	400 to 4200	100rpm	3600rpm

	Item	Setting range	Edit unit	Initial display
K08	Compensation of unsteady needle thread tension Output value of needle thread tension is wholly offset and compensated. 	-30 to 30	1	0
K09	Output time of needle thread tension changed value When data related to needle thread tension is changed, the changed value is output as long as the set-up time.  : Without output  : Output of set-up time	0 to 20	1s	Without output
K10	Function of origin retrieval each time Origin retrieval is performed after completion of sewing.  : Without  : After end of cycle  : After end of sewing	---	---	Without
K11	Needle up by reverse run Effective/ Ineffective When U01 Presser lifter maximum position is set to 14.0 mm or more, motion of needle up by reverse run is automatically performed and the machine stops. Prohibition of the motion can be set.  : Needle up by reverse run prohibited  : Needle up by reverse run permitted	---	---	Permitted
K12	Knife solenoid lowering time setting 	25 to 100	5ms	35
K13	Knife solenoid lifting time setting 	5 to 100	5ms	15

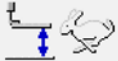
	Item	Setting range	Edit unit	Initial display
K14	KNIFE CYLINDER LOWERING TIME (OPTIONAL) 	5 to 300	5ms	70
K15	Y-feed motor origin compensation 	-120 to 400	1 pulse (0.025 mm)	0
K16	Needle-rocking motor origin compensation 	-10 to 10	1 pulse (0.05 mm)	0
K17	Presser lifter motor origin compensation 	-100 to 10	1 pulse (0.05 mm)	0
K18	Display/Non-display of direct button  : Display  : Non-display	---	---	Non-display
K19	Thread trimming on the way in continuous stitching Permitted/ Prohibited. In case of prohibited, jump feed setting becomes invalid, and the registered pattern is sewn at the same position. Then multi-sewing is possible.  : Permitted  : Prohibit	---	---	Permitted
K20	Changeover of cloth cutting knife return power This item sets output power at the time of returning the cloth cutting knife. 	0 to 3	1	0
K21	Release amount of bobbin thread trimmer at the start of sewing This item sets the amount of releasing the bobbin thread trimmer at the start of sewing. 	1 to 15	1 pulse	8
K22	Presser lifter speed selection 	1 to 3	1	1

27. EXPLANATION OF PLURAL MOTIONS OF KNIFE

This sewing machine can automatically actuate the knife plural times and sew a buttonhole larger than the size of knife by setting the size of knife attached from the operation panel. Set and use this function when sewing various sewing shapes without replacing the knife.

① Display the memory switch list screen.

When **M** switch is pressed, memory switch

button  (A) is displayed on the screen.

When this button is pressed, the memory switch list screen is displayed.

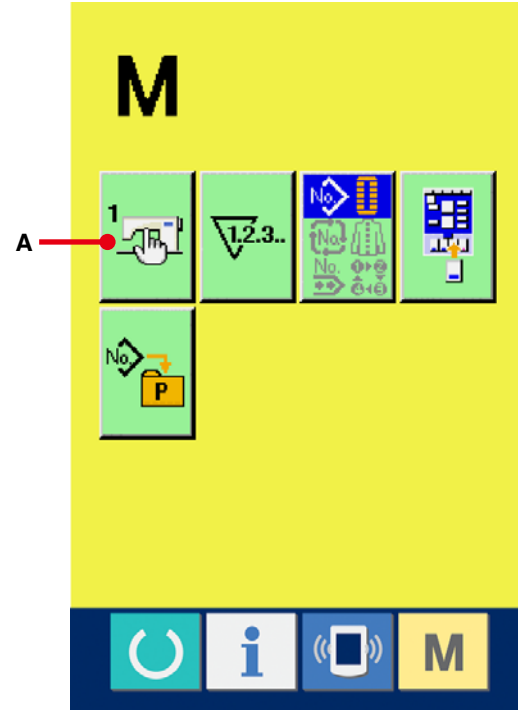

② Select **U18** Cloth cutting knife size button.

Press UP/DOWN SCROLL button  (B)

and select **U18** Cloth cutting knife size button

 (C). The cloth cutting knife size input screen is displayed.

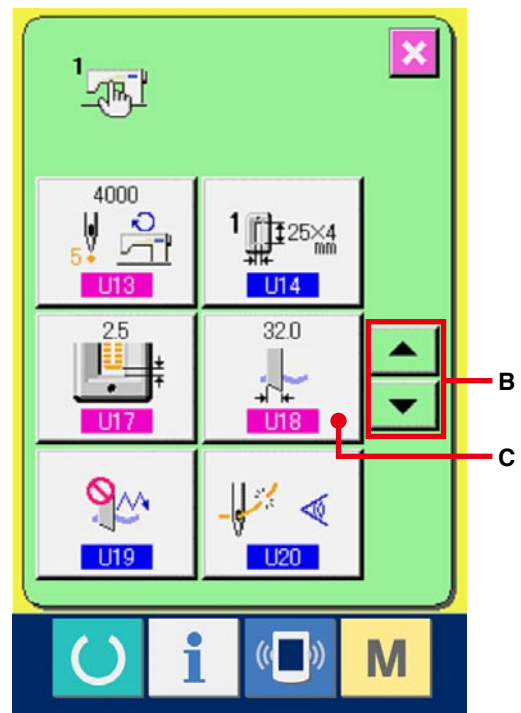

③ **Input the cloth cutting knife size.**

Press plus/minus buttons  (D) and input the size of knife attached.

④ **Determine the cloth cutting knife size.**

When ENTER button  (E) is pressed, the cloth cutting knife size input screen is closed and the input has been completed. Then the screen returns to the memory switch list screen.

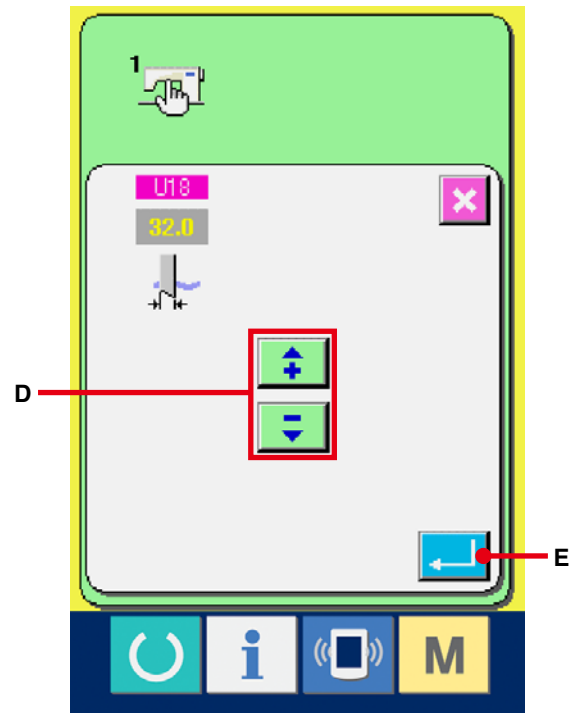

⑤ **Select U19 Function of plural motions of cloth cutting knife button.**

Press UP/DOWN SCROOL button and select U19 Function of plural motions of cloth cutting knife button  (F). The function of plural motions of cloth cutting knife selection screen is displayed.

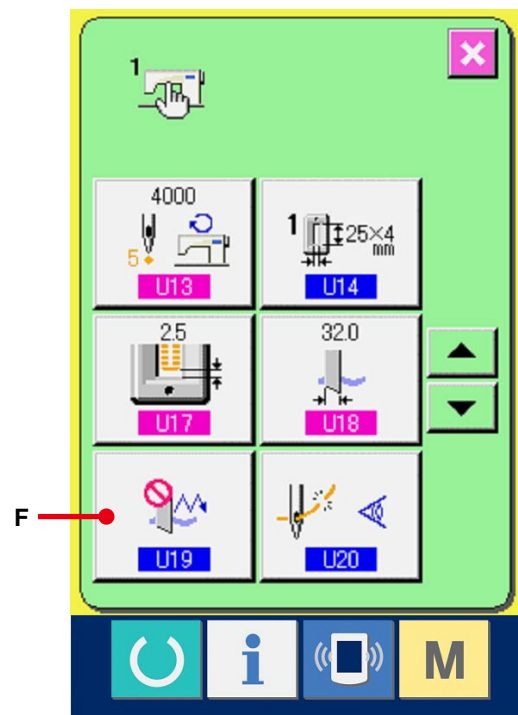

⑥ **Make effective the function of plural motions of cloth cutting knife.**

Select the effective button (G).

⑦ **Determine the function of plural motions of cloth cutting knife.**

When ENTER button  (H) is pressed, the function of plural motions of cloth cutting knife screen is closed and the selection of the function of plural motions of cloth cutting knife has been completed.

Then the screen returns to the memory switch list screen.

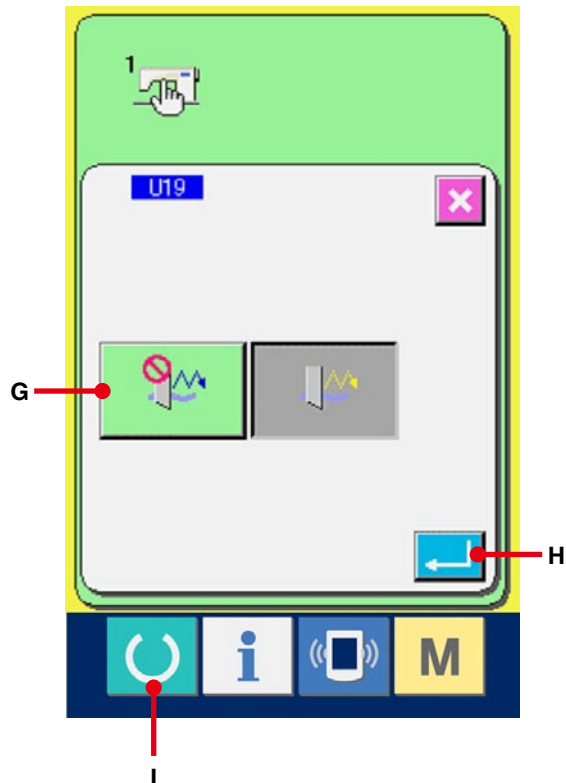

⑧ **Perform sewing.**







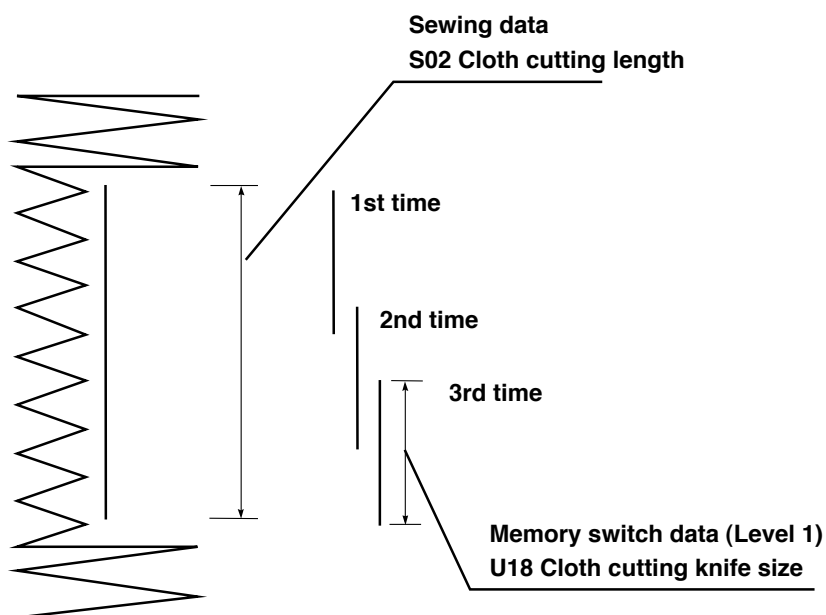

When READY switch  (I) is pressed, the sewing screen (green) is displayed. At this time, when









S02 Cloth cut length is set to larger than **U18** Cloth cutting knife size which has been set in step ③, the sewing machine automatically actuates plural motions of knife and performs sewing.



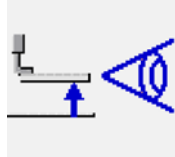

※ When you desire to sew the hole shape smaller than the size of knife attached, error 489 appears.





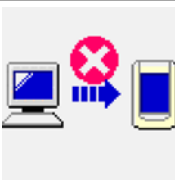
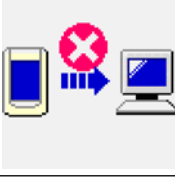
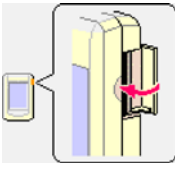
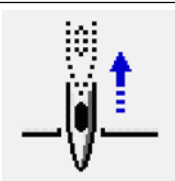

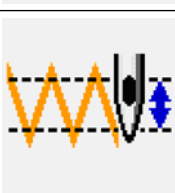

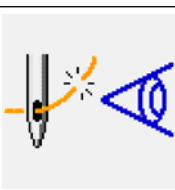



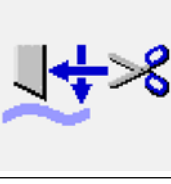

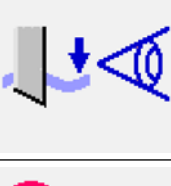

28. ERROR CODE LIST



Error code		Description of error	How to recover	Place of recovery
E001		Contact of initialization of EEP-ROM of MAIN CONTROL p.c.b. When data is not written in EEP-ROM or data is broken, data is automatically initialized and the initialization is informed.	Turn OFF the power.	
E007		Main shaft motor-lock When large needle resistance sewing product is sewn	Turn OFF the power.	
E011		External media not inserted External media is not inserted.	Possible to re-enter after reset	
E012		Read error Data read from external media cannot be performed.	Possible to re-start after reset.	Previous screen
E013		Write error Data write from external media cannot be performed.	Possible to re-start after reset.	Previous screen
E014		Write protect External media is in the write prohibition state	Possible to re-start after reset.	Previous screen
E015		Format error Format cannot be performed.	Possible to re-start after reset.	Previous screen
E016		External media capacity over Capacity of external media is short.	Possible to re-start after reset.	Previous screen

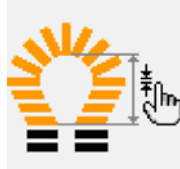
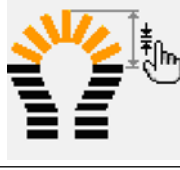

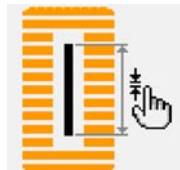
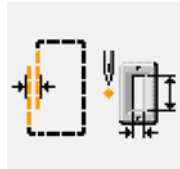
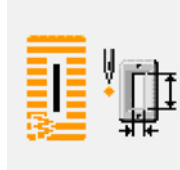
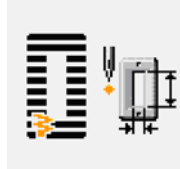
Error code		Description of error	How to recover	Place of recovery
E017		EEP-ROM capacity over Capacity of EEPROM is short.	Possible to re-start after reset.	Previous screen
E018		Type of EEPROM is different. When the mounted EEPROM is different in type.	Possible to re-start after reset.	Previous screen
E019		File size over File is too large.	Possible to re-start after reset.	Previous screen
E022		File No. error Designated file is not in server or Media.	Possible to re-start after reset.	Previous screen
E023		Detection of step-out of presser lifting motor When step-out of motor is detected at the time when presser lifting motor passes origin sensor or starts operation.	Possible to re-start after reset.	Data input screen
E024		Pattern data size over When sewing cannot be performed since total size of continuous stitching data or size of downloaded data is too large.	Possible to re-start after reset.	Data input screen
E025		Detection of step-out of needle thread trimmer motor When step-out of motor is detected at the time when needle thread trimmer motor passes origin sensor or starts operation.	Possible to re-start after reset.	Data input screen
E026		Detection of step-out of bobbin thread trimmer motor When step-out of motor is detected at the time when bobbin thread trimmer motor passes origin sensor or starts operation.	Possible to re-start after reset.	Data input screen

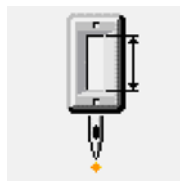

Error code		Description of error	How to recover	Place of recovery
E027		Read error Data read from server cannot be performed.	Possible to re-start after reset.	Previous screen
E028		Write error Data write from server cannot be performed.	Possible to re-start after reset.	Previous screen
E029		Lid of Media slot is open.	Possible to re-start after reset.	Previous screen
E030		Needle bar upper position failure When needle does not stop at UP position even with needle. UP operation at the time of starting sewing machine.	Possible to re-start after reset.	Previous screen
E042		Operation error peration of sewing data cannot be performed.	Possible to re-start after reset.	Previous screen
E043		Enlarging error Sewing pitch exceeds 5 mm.	Possible to re-start after reset.	Data input screen
E050		Stop switch When stop switch is pressed during machine running.	Possible to re-start after reset.	Step screen
E052		Thread breakage detection error When thread breakage has occurred during machine running.	Possible to re-start after reset.	Step screen

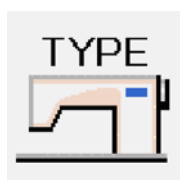
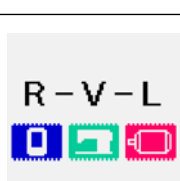
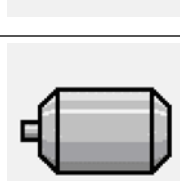
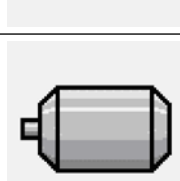

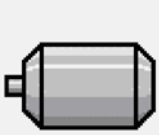
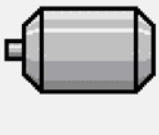
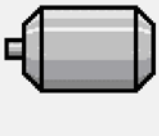
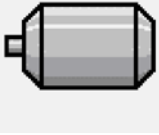
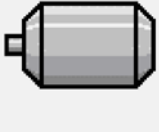
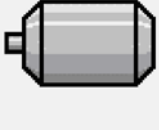

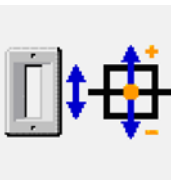
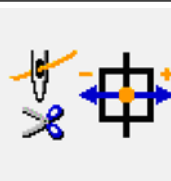
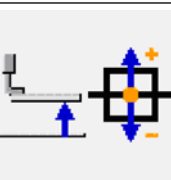
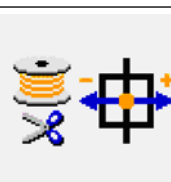

Error code		Description of error	How to recover	Place of recovery
E061		Memory switch data error When memory switch data is broken or revision is old.	Turn OFF the power.	
E062		Sewing data error When sewing data is broken or revision is old.	Turn OFF the power.	
E099		Interference of knife lowering command with thread trimming motion When inserting position of knife command is improper and knife command interferes with thread trimming motion in case of motion from external data.	Possible to re-start after reset.	Data input screen
E302		Confirmation of tilt of machine head When tilt of machine head sensor is OFF.	Possible to re-start after reset.	Data input screen
E303		Main shaft semilunar plate sensor error Semilunar plate of sewing machine motor is abnormal.	Turn OFF the power.	
E304		Cloth cutting knife sensor error When knife is held lowered or sensor is not OFF when knife is lowered.	Turn OFF the power.	
E401		Copy disapproval error When trying to perform copying to the pattern No. which has been registered.  : In case of continuous stitching  : In case of cycle stitching	Possible to re-start after pressing cancel button.	Pattern list screen
E402		Pattern deletion error When trying to perform deletion in case the remaining pattern No. which has been registered is only one.  : In case of continuous stitching  : In case of cycle stitching	Possible to re-start after pressing cancel button.	Pattern list screen

Error code		Description of error	How to recover	Place of recovery
E486		Eyelet knife length error When the shape is not formed since the eyelet knife length is too short in case of eyelet shape.	Possible to re-start after reset.	Sewing data input screen S17
E487		Eyelet shape length error Eyelet shape length is too short to form the shape in case of eyelet shape.	Possible to re-start after reset.	Sewing data input screen S14
E488		Flow bar-tacking compensation error When bar-tacking length is too short to form the shape in case of flow bar-tacking shape.	Possible to re-start after reset.	Sewing data input screen S08
E489		Knife size error (at the time of plural motions of knife) When knife size is larger than cloth cutting knife size.	Possible to re-start after reset.	Sewing data input screen S02
E492		Presser size over of basting When stitching data of basting exceeds presser size.	Possible to re-start after reset.	Sewing data input screen S40
E493		Presser size over of tie stitching at sewing end When stitching data of tie stitching at sewing end exceeds presser size.	Possible to re-start after reset.	Sewing data input screen S67
E494		Presser size over of tie stitching at sewing start When stitching data of tie stitching at sewing start exceeds presser size.	Possible to re-start after reset.	Sewing data input screen S64
E495		Presser size error (Width direction : right only) When stitching data exceeds the size of right only of width direction of presser.	Possible to re-start after reset.	Sewing data input screen S03 S06

Error code		Description of error	How to recover	Place of recovery
E496		Presser size error (Width direction : left only) When stitching data exceeds the size of left only of width direction of presser.	Possible to re-start after reset.	Sewing data input screen
E497		Presser size error (Length direction : front) When stitching data exceeds the size of front of length direction of presser.	Possible to re-start after reset.	Sewing data input screen
E498		Presser size error (Width direction : right and left) When stitching data exceeds the size of both right and left of width direction of presser.	Possible to re-start after reset.	Sewing data input screen S05
E499		Presser size error (Length direction : rear) When stitching data exceeds the size of rear of length direction of presser.	Possible to re-start after reset.	Sewing data input screen S02
E703		Panel is connected to the machine other than supposed. (Machine type error) When machine type code of system is improper in case of initial communication.	Possible to rewrite program after pressing down communication switch.	Communication screen
E704		Nonagreement of system version When version of system software is improper in case of initial communication.	Possible to rewrite program after pressing down communication switch.	Communication screen
E730		Main shaft motor encoder defectiveness or phase-out When encoder of sewing machine motor is abnormal.	Turn OFF the power.	
E731		Main motor hole sensor defectiveness or position sensor defectiveness When hole sensor or position sensor of sewing machine is defective.	Turn OFF the power.	

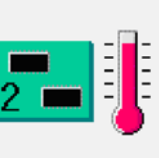
Error code		Description of error	How to recover	Place of recovery
E733		Reverse rotation of main shaft motor When sewing machine motor rotates in reverse direction.	Turn OFF the power.	
E801		Phase-lack of power When phase-lack of input power occurs.	Turn OFF the power.	
E802		Power instantaneous cut detection When input power is instantaneously OFF.	Turn OFF the power.	
E811		Overvoltage When input voltage is 280V or more.	Turn OFF the power.	
E813		Low voltage When input voltage is 150V or less.	Turn OFF the power.	
E901		Abnormality of main shaft motor IPM When IPM of servo control p.c.b. is abnormal.	Turn OFF the power.	
E902		Overcurrent of main shaft motor When current flows excessively to sewing machine motor.	Turn OFF the power.	
E903		Abnormality of stepping motor power When stepping motor power of servo control p.c.b. fluctuates $\pm 15\%$ or more.	Turn OFF the power.	

Error code		Description of error	How to recover	Place of recovery
E904		Abnormality of solenoid power When solenoid power of servo control p.c.b. fluctuates $\pm 15\%$ or more.	Turn OFF the power.	
E905		Abnormality of temperature of heat sink for servo control p.c.b. When temperature of heat sink of servo control p.c.b. is 85°C or more.	Turn OFF the power.	
E907		Zigzag width motor origin retrieval error When origin sensor signal is not inputted at the time of origin retrieval motion.	Turn OFF the power.	
E908		Y-feed motor origin retrieval error When origin sensor signal is not inputted at the time of origin retrieval motion.	Turn OFF the power.	
E909		Needle thread trimmer motor origin retrieval error When origin sensor signal is not inputted at the time of origin retrieval motion.	Turn OFF the power.	
E910		Presser motor origin retrieval error When origin sensor signal is not inputted at the time of origin retrieval motion.	Turn OFF the power.	
E911		Bobbin thread trimmer motor origin retrieval error When origin sensor signal is not inputted at the time of origin retrieval motion.	Turn OFF the power.	

Error code		Description of error	How to recover	Place of recovery
E915		Abnormality of communication between operation panel and main CPU When abnormality occurs in data communication.	Turn OFF the power.	
E916		Abnormality of communication between main CPU and main shaft CPU When abnormality occurs in data communication.	Turn OFF the power.	
E917		Failure of communication between operation panel and personal computer When abnormality occurs in data communication.	Turn OFF the power.	
E918		Abnormality of temperature of heat sink for main control p.c.b. When temperature of heat sink of main control p.c.b. is 85°C or more.	Turn OFF the power.	
E943		Defectiveness of EEPROM of main control p.c.b. When data writing to EEPROM is not performed.	Turn OFF the power.	
E946		Defectiveness of writing to EEPROM of head relay p.c.b. When data writing to EEPROM is not performed.	Turn OFF the power.	
E948		Abnormality of F ROM. When deletion or writing of F ROM is not performed at the time of downloading program.	Turn OFF the power.	
E999		When cloth cutting knife does not return When cloth cutting knife does not return after the lapse of predetermined time.	Turn OFF the power.	

29. USING COMMUNICATION FUNCTION



Communication function can download the sewing data created with other sewing machine, creation of sewing data and sewing data created by editing device PM-1 to the sewing machine. In addition, the function can upload the aforementioned data to the media or personal computer.

Media and RS-232C port are prepared as the vehicle to communicate.

※ However, SU-1 (data server utility) is necessary to perform download/upload from the personal computer.

29-1 Handling possible data

Handling possible sewing data are two kinds below. The respective data formats are as described below.

Data name		Extension	Description of data
Vector format data		VD00 xxx. VDT	Data of the needle entry point created with PM-1. Format of the data which can be used in common among JUKI sewing machines.
Parameter data		LBH00 xxx. EPD	Format of the data of sewing proper to LBH such as sewing shape, cloth cutting length, overedging width, etc. created with the sewing machine.

xxx : file NO.

In case of saving the data in the Media, save the data in the state of directory structure below.

When the data are not saved in the correct folder, reading of file cannot be performed.

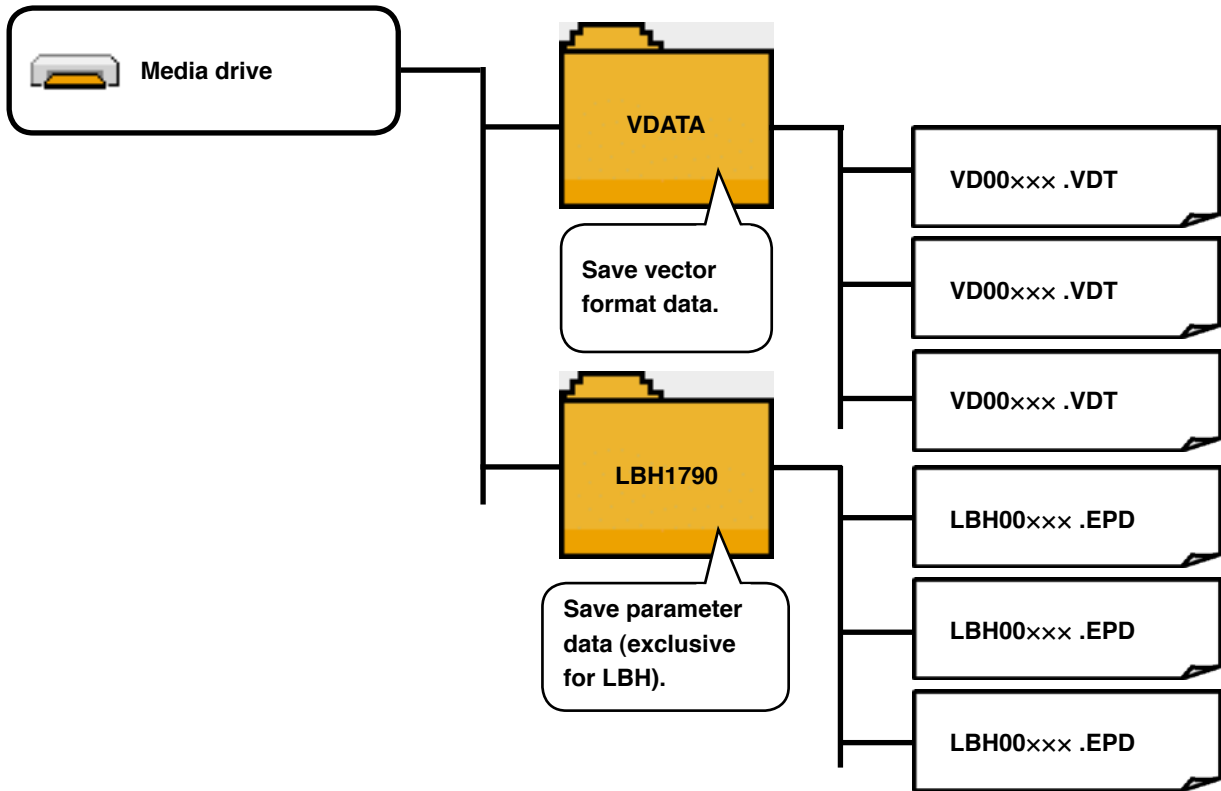

※ There is beforehand the PROG folder in the Media purchased from our company. Do not delete it.

29-2 Performing communication by using the media

1) Inserting direction of the media

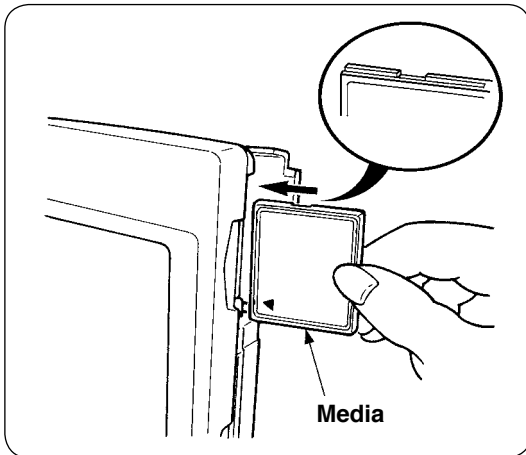

- ① Turn the label side of the CompactFlash (TM) to this side (place the notch of the edge to the rear.) and insert the part that has a small hole into the panel.



1. If the inserting direction of the media is wrong, panel and media may be damaged.
2. Do not insert anything other than CompactFlash (TM).
3. IP-310 is adaptable to CompactFlash (TM) of 2GB or less.
4. IP-310 is adaptable to the format FAT16 of CompactFlash (TM). It is not adaptable to FAT32.
5. Be sure to use the CompactFlash (TM) formatted with IP-310. For formatting procedure of CompactFlash (TM), see [“29-2-3\) Performing format”, p.101.](#)

- ② After setting the media, close the cover. By closing the cover it is possible to access.
If the media and the cover come in contact with each other, and the cover fails to close, make sure of the matters below.
 - Media is securely pushed to the rear ?
 - Inserting direction of the media is proper ?

2) Removing procedure of the media

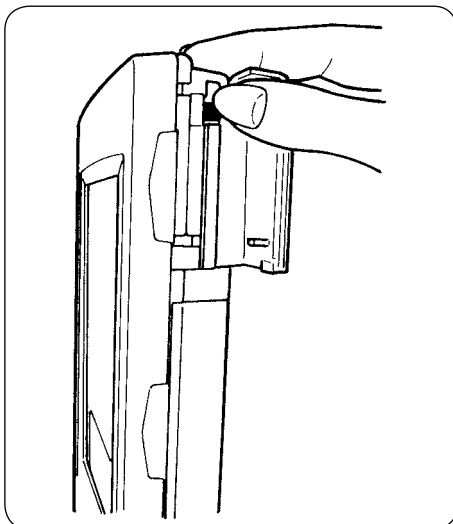

- ① Hold the panel by hand, open the cover, and press the media removing lever. The media is ejected.



If the lever is strongly pressed, the media protrudes and falls. As a result, it may be damaged.

- ② Draw out the media as it is, and removing is completed.

Cautions when using the CompactFlash (TM) :



- Do not wet it or touch it with wet hands. Fire or electric shock may be caused.
- Do not bend it or apply strong force or shock to it.
- Never perform disassembling or remodeling of it.
- Do not make the contact part of it come in contact with the metal. Data may disappear.
- Avoid storing or using it at the places below.

Place of high temperature and humidity / Place of dew condensation /

Place of much waste and dust / Place where static electricity or electrical noise is apt to occur

3) Performing format

In case of re-formatting the Media, be sure to perform it with IP-310. The Media formatted with the personal computer cannot be read with IP-310.

① Display the media format screen.

When **M** switch is held pressed for three seconds, media format button  (A) is displayed on the screen. When this button is pressed, the media format screen is displayed.

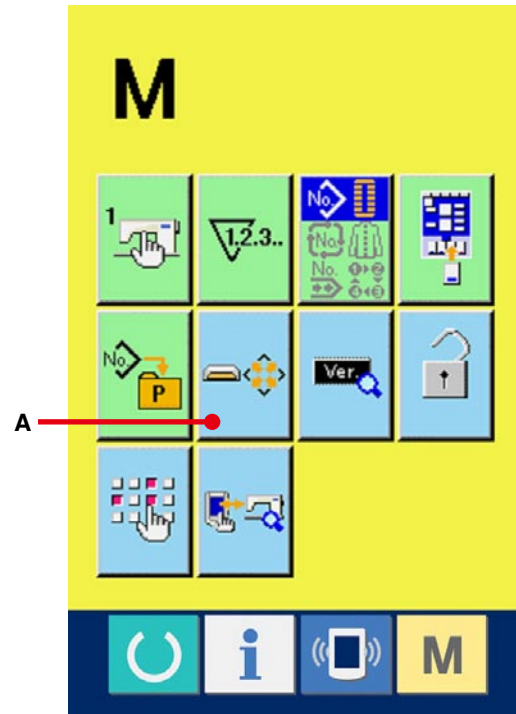

① Start formatting of the Media.

Set the media you desire to format to the media slot, close the cover, press ENTER button  (B) and formatting starts.

Save necessary data in the media to the other vehicle before formatting. When formatting is performed, the inside data are deleted.

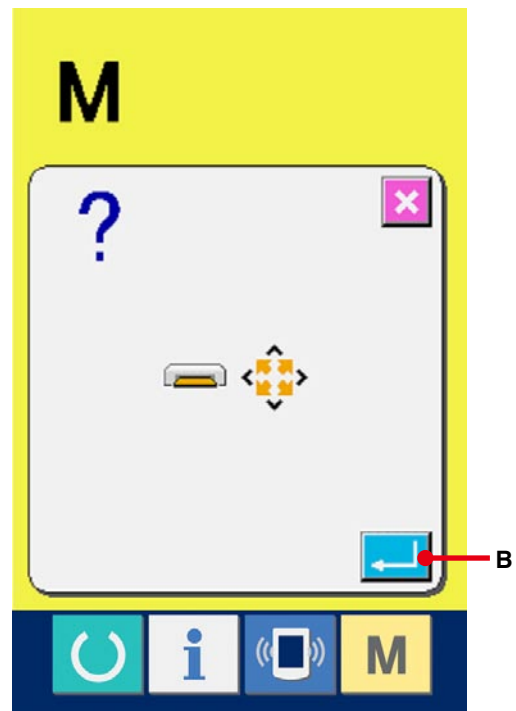

[Prohibition items in handling the media]

- ① Media is a precision electronic instrument. Do not bend it or apply shock to it.
- ② It is recommended to periodically save the data saved in the media to the other vehicle to prepare for accidents.
- ③ When initializing the data, perform it after checking that necessary data do not exist in the card.
- ④ Avoid using or storing the media in a place of high temperature and high humidity.
- ⑤ Avoid using the media near exothermic and combustible articles.
- ⑥ If the contact part of the card becomes dirty, failure of contact will be caused. Do not touch by hand, and control so that dust, oil, or other foreign material does not adhere to it. In addition, the inside element is damaged by static electricity or the like. So, be very careful when handling.
- ⑦ Media has a span of life. Writing and deletion cannot be performed after an extended period of use. In this case, replace it with a new one.

29-3 Performing communication by using RS-232C

[Setting procedure]

It is possible to send and receive the data, by using RS-232C cable, with the personal computer or the like. For the cable to be connected, connect reverse type 9-pin (female) to the operation panel side.

Caution : If the contact part becomes dirty, failure of contact will be caused. Do not touch by hand, and control so that dust, oil or other foreign material does not adhere to it. In addition, the inside element is damaged by static electricity or the like. So, be very careful when handling.

(Setting procedure)

When the lower part of the cover located on the side of the operation panel is opened, there is the connector of 9-pin for RS-232C. Connect the cable there. When the screw for locking is attached to the connector, tighten the screw to prevent it from falling.

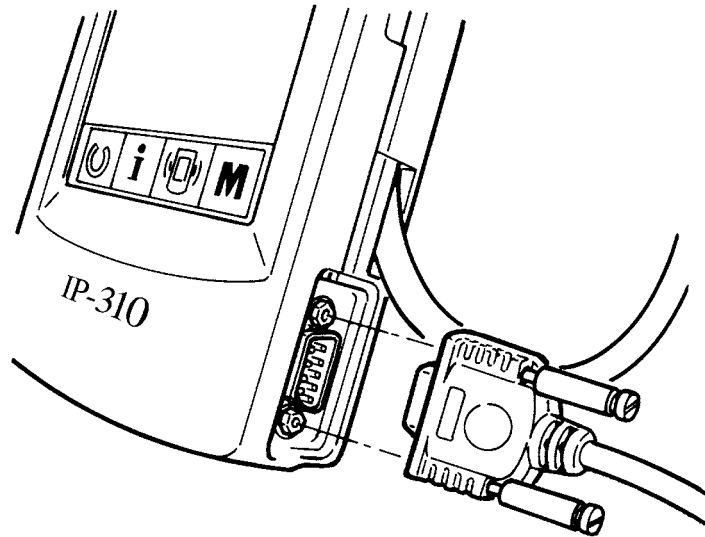

29-4 Take-in of the data

① Display the communication screen.

When communication switch  (A) of switch seat section is pressed in the data input screen, the communication screen is displayed.

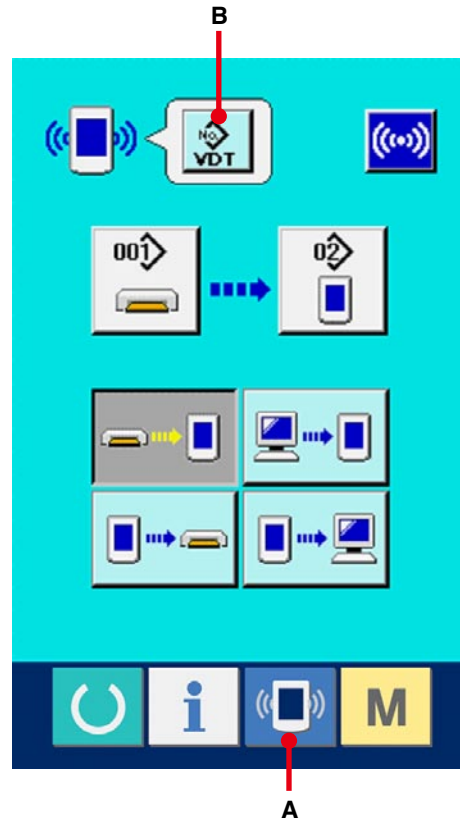

② Select the kind of data.

When data selection button  (B) is pressed, the data selection screen is displayed. Select button (C) of kind of data to be communicated. The selected button is displayed in reverse video.

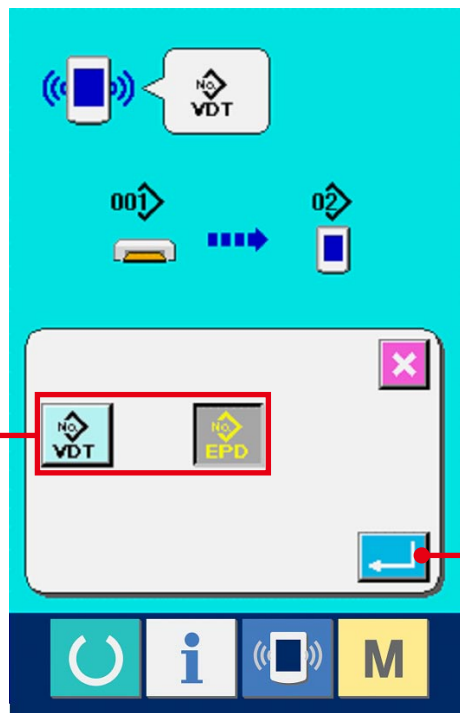

③ Determine the kind of data.

When ENTER button  (D) is pressed, the kind of data selection screen is closed and the selection of the kind of data has been completed.

④ **Select the communication procedure.**

There are four communication procedures as described below.

- (E) Writing data from media to panel
- (F) Writing data from personal computer (server) to panel
- (G) Writing data from panel to media
- (H) Writing data from panel to personal computer (server)

Select the button of communication procedure you desire.

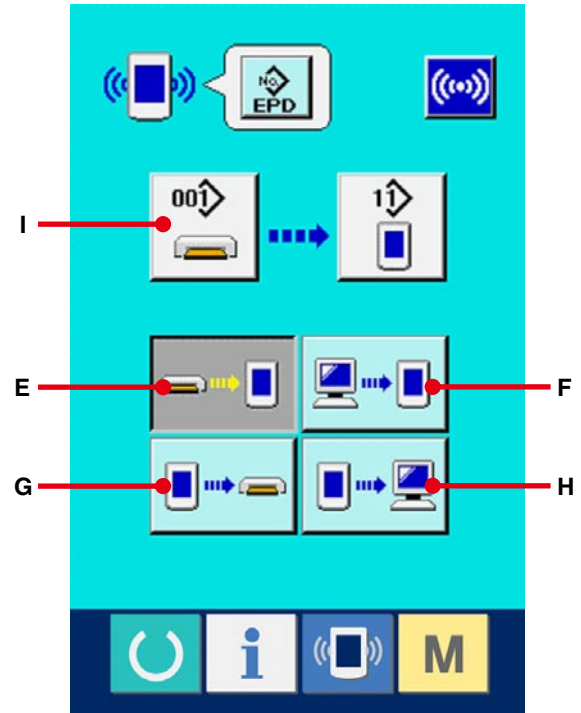

⑤ **Select the data No.**

When  (I) is pressed, the writing file selection screen is displayed.

Input the file No. of the data you desire to write.
For the file No., input the numerals of the part xx x of VD00xxx.vdt of the file name.

Designation of the pattern No. of writing destination can be performed in the same way.
When the writing destination is the panel, pattern Nos. which have not been registered are displayed.

⑥ **Determine the data No.**

When ENTER button  (J) is pressed, the data No. selection screen is closed and the selection of the data No. has been completed.

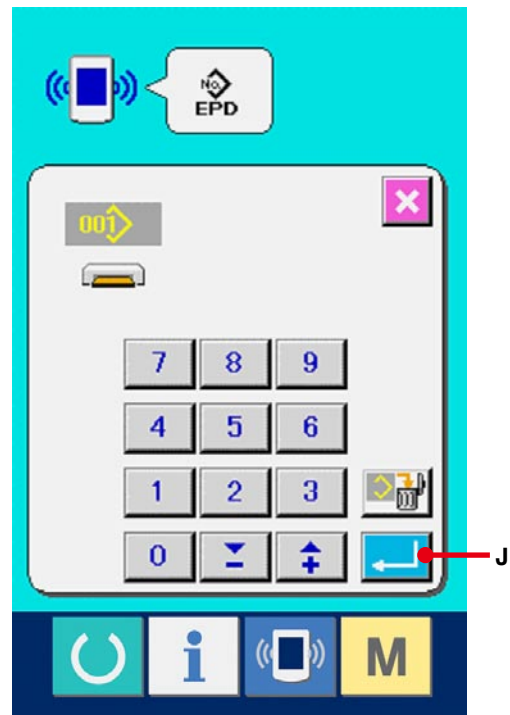

⑦ **Start communication.**

When communication button (K) is pressed, the data communication starts. The communication screen is displayed during communication and the screen returns to the communication screen after the end of communication.

- * Do not open the cover during reading the data.
Data may not be read in.

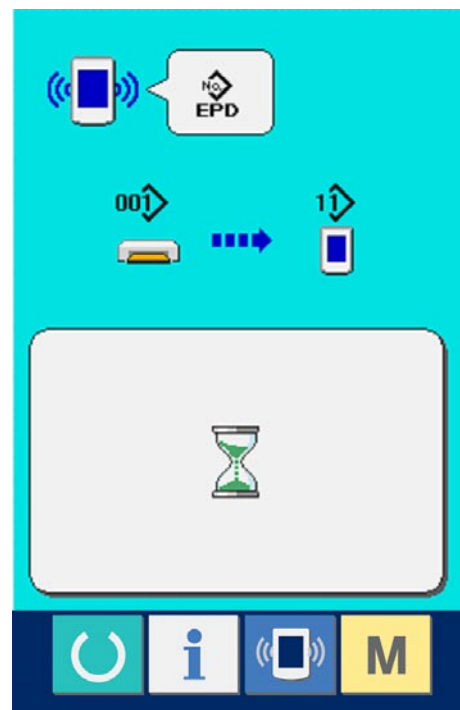
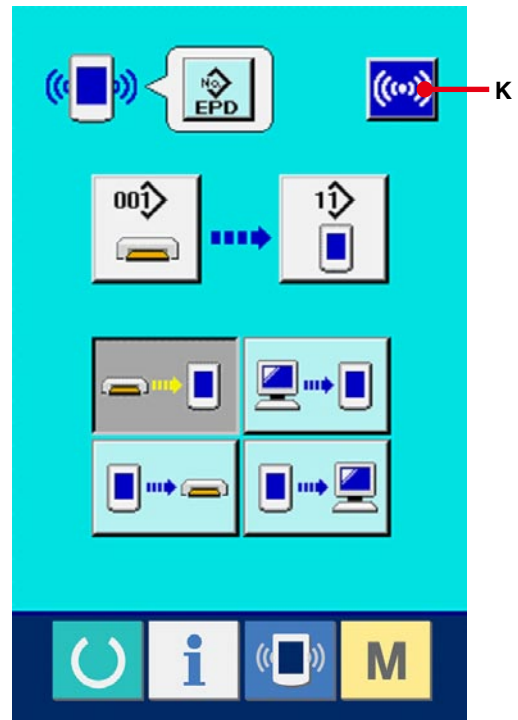

30. INFORMATION FUNCTION

There are three functions below in the information function.

- 1) Oil replacement time, needle replacement time, cleaning time, etc. are designated and the warning notice is performed when the designated time has passed.
→ Refer to [30-1 Observing the maintenance and inspection information, p.108](#) and [30-2 Inputting the maintenance and inspection time, p.111](#).

- 2) Speed can be checked at a glance and the target achieving consciousness as a line or group is increased as well by the function to display the target output and the actual output.
→ Refer to [30-4 Observing the production control information, p.114](#) and [30-5 Performing setting of the production control information, p.117](#).

- 3) Information on machine working ratio, pitch time, machine time and machine speed can be displayed from the working state of the sewing machine.
→ Refer to [30-6 Observing the working measurement information, p.121](#).

In addition, information on plural sewing machines can be controlled by the server when this function is used by connecting SU-1 (sewing machine data server utility) with the sewing machines.

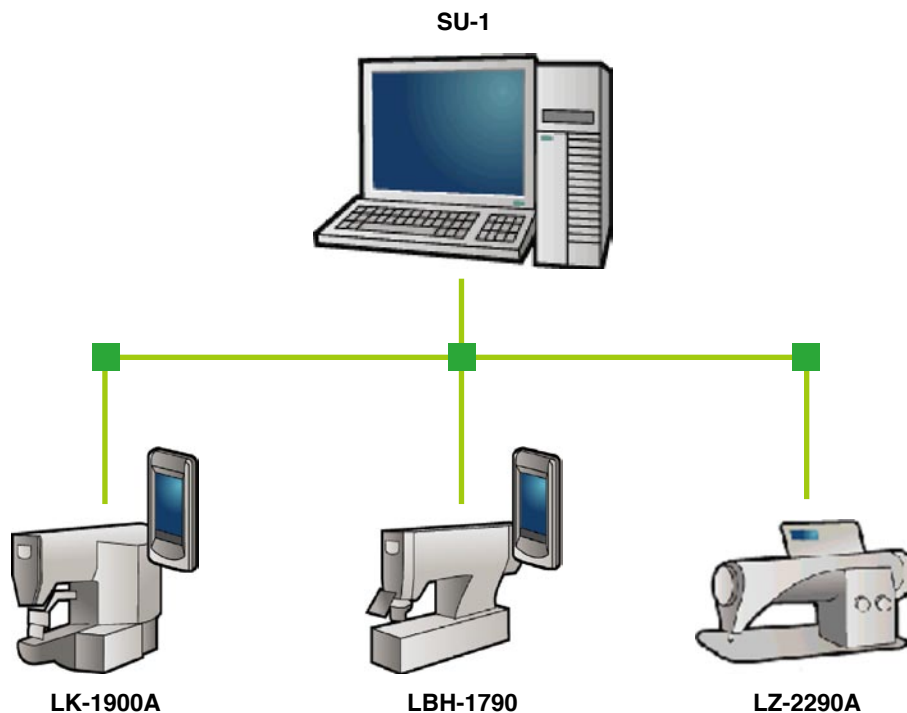

30-1 Observing the maintenance and inspection information

① **Display the information screen.**

When information key  (A) of the switch seat section is pressed in the data input screen, the information screen is displayed.

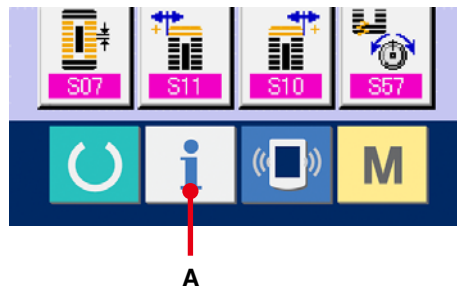

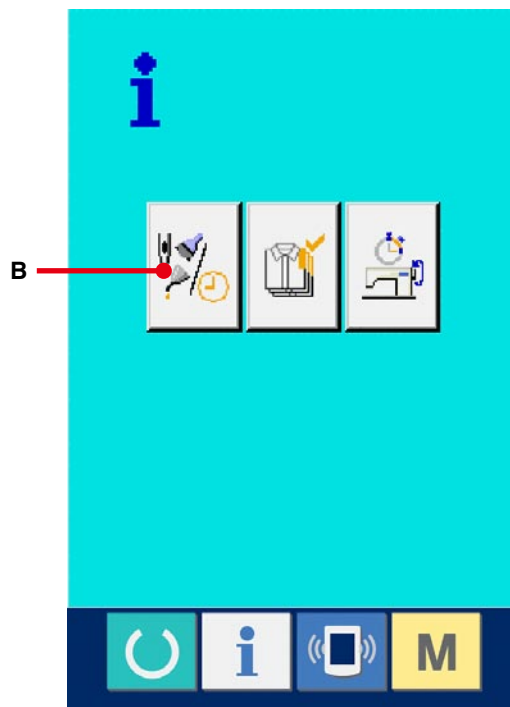

② **Display the maintenance and inspection information screen.**

Press maintenance and inspection informationscreen display button  (B) in the information screen.



Information on the following three items is displayed in the maintenance and inspection information screen.

- Needle replacement :  (1,000 stitches)
- Cleaning time (hour) : 
- Oil replacement time (hour) : 

The interval to inform of the inspection for each item in button (C) is displayed at (D), and remaining time up to the replacement is displayed at (E). In addition, remaining time up to the replacement can be cleared.

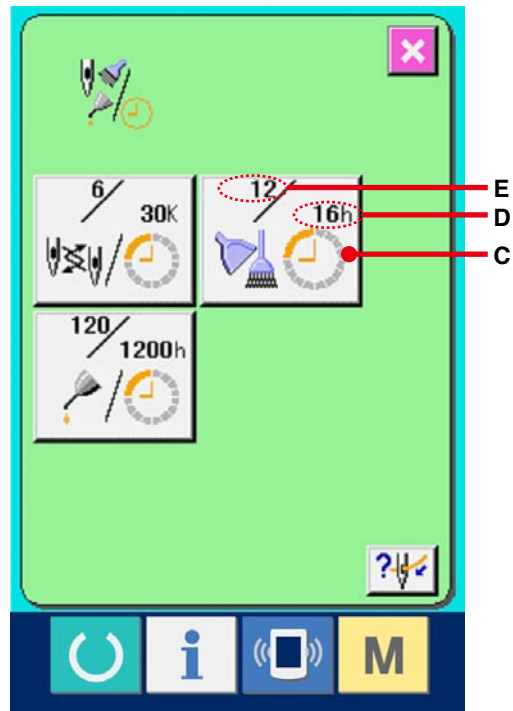

③ **Perform clearing remaining time up to the replacement.**

When button (C) of the item you desire to clear is pressed, the time of replacement clear screen is displayed. When clear button  (F) is pressed, the remaining time up to the replacement is cleared.

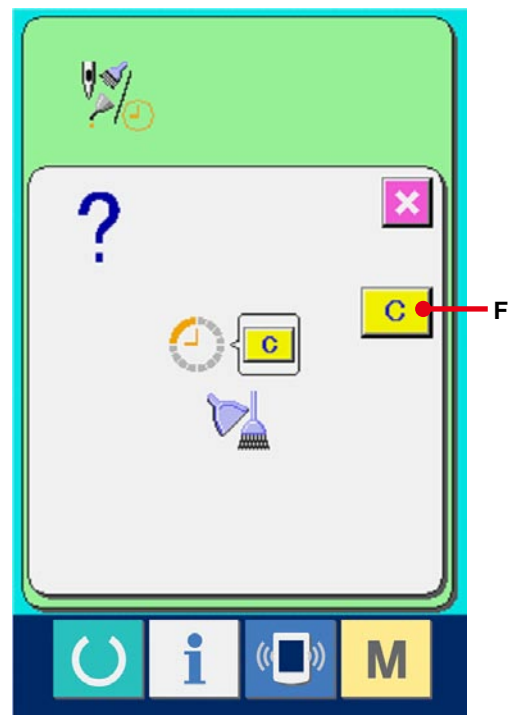

④ **Display the threading diagram.**

When threading button  (G) displayed in the maintenance and inspection screen is pressed, the needle thread threading diagram is displayed. Observe it when performing threading.

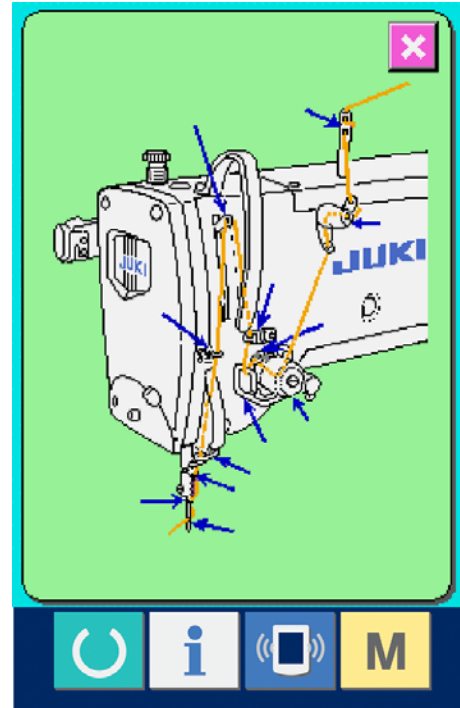

30-2 Inputting the inspection time

① Display the information screen (maintenance personnel level).

When information key  (A) of the switch seat section is pressed in the data input screen for approximately three seconds, information screen (maintenance level) is displayed. In case of the maintenance personnel level, the pictograph located on the upper left side changes from blue to orange, and five buttons are displayed.

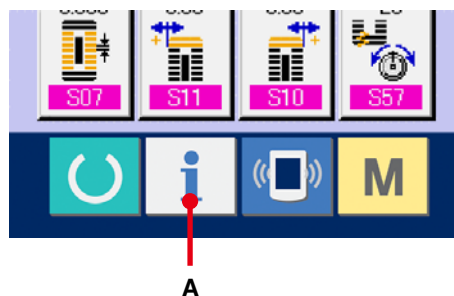

② Display the maintenance and inspection information screen.

Press maintenance and inspection information screen display button  (B) in the information screen.

※ For the two buttons displayed in the bottom stage at the time of the maintenance personnel level, refer to [36. INFORMATION SCREEN OF THE MAINTENANCE PERSONNEL LEVEL, p.145](#).

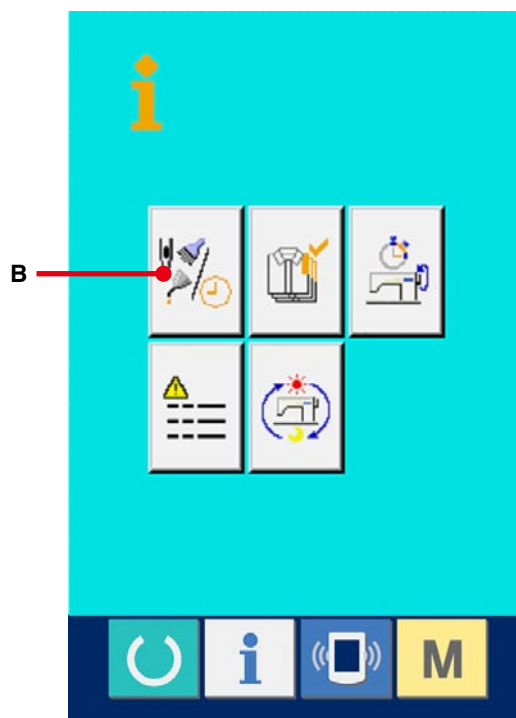

The same information as that in the normal maintenance and inspection information screen is displayed in the maintenance and inspection information screen.

When button (C) of the item you desire to change the inspection time is pressed, the inspection time input screen is displayed.

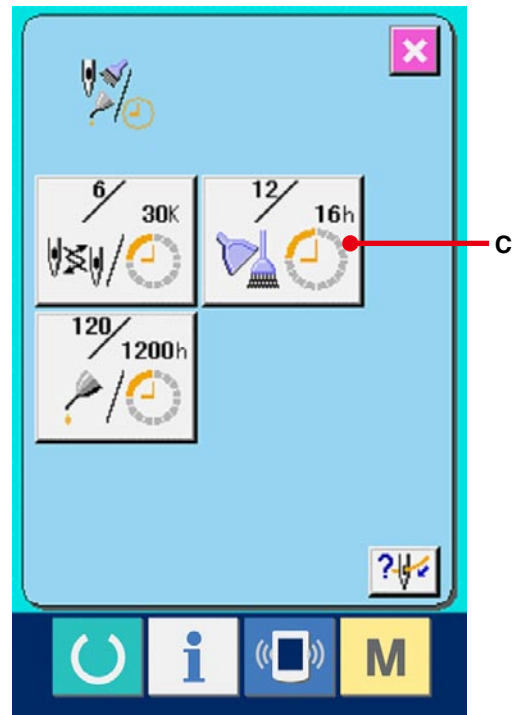

③ Input the inspection time.

Input the inspection time.

When the inspection time is set to "0", the warning function stops.

When clear button **C** (D) is pressed, the value returns to the initial value.

The initial values of the inspection time of respective items are as follows.

- Needle replacement : 0 (1,000 stitches)
- Cleaning time : 0 (hour)
- Oil replacement time : 200 (hour)

When ENTER button  (E) is pressed, the inputted value is determined.

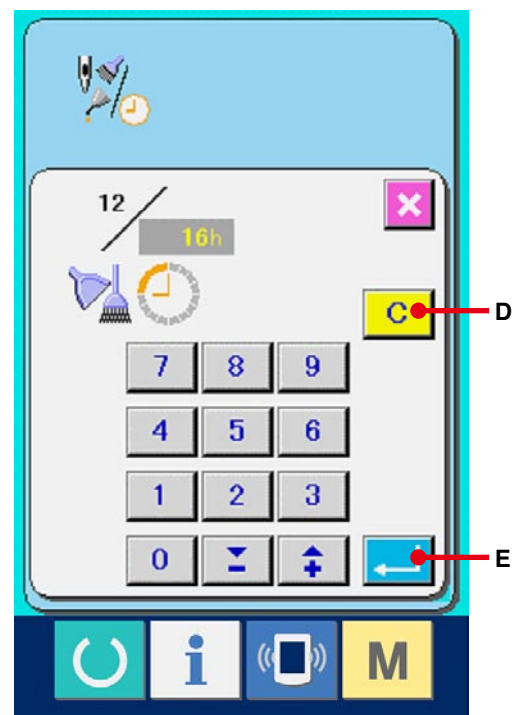

30-3 Releasing procedure of the warning

When the designated inspection time is reached, the warning screen is displayed.

In case of clearing the inspection time, press CLEAR button **C** (F). The inspection time is cleared and the pop-up is closed. In case of not clearing the inspection time, press CANCEL button **X** (G) and close the pop-up. Every time one sewing is completed, the warning screen is displayed until the inspection time is cleared.

Warning Nos. of the respective items are as follows.

- Needle replacement : A201
- Cleaning time : A202
- Oil replacement time : A203

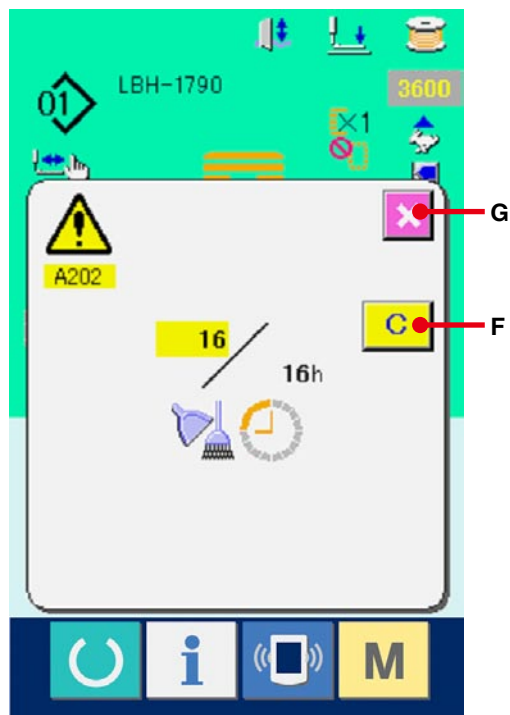

30-4 Observing the production control information

It is possible to designate the start, display the number of pieces of production from the start to the existing time, display the number of pieces of production target, etc. in the production control screen.

There are two kinds of display ways for the production control screen.

30-4-1 When displaying from the information screen

① **Display the information screen.**

When information key  (A) of the switch seat section is pressed in the data input screen, the information screen is displayed.

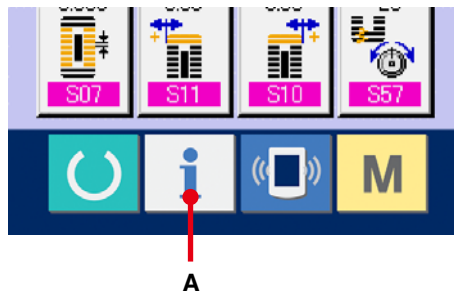

② **Display the production control screen.**

Press production control screen display button  (B) in the information screen. The production control screen is displayed.

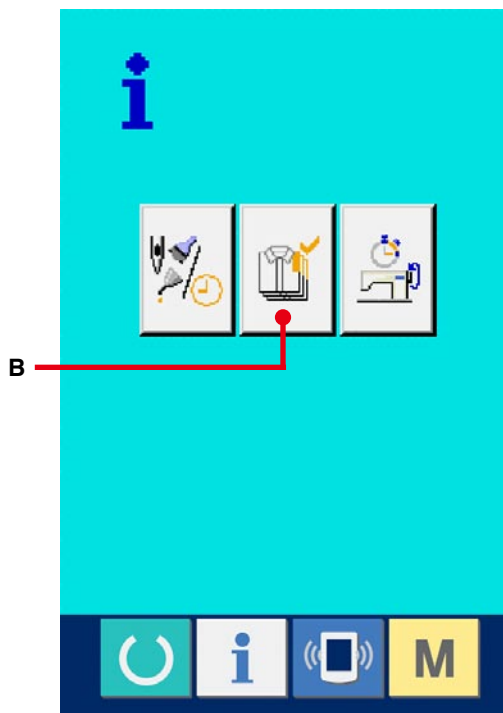

Information on the following 5 items is displayed in the production control screen.

A : Existing target value

Number of pieces of the target of products at the present time is automatically displayed.

B : Actual results value

Number of pieces of the sewn products is automatically displayed.

C : Final target value

Number of pieces of the final target of products is displayed.

Input the number of pieces referring to [30-5 Performing setting of the production control information p.117](#).

D : Pitch time

Time (second) required for one process is displayed.

Input the time (unit : second) referring to [30-5 Performing setting of the production control information, p.117](#).

E : Number of times of thread trimming

Number of times of thread trimming per process is displayed.

Input the number of times referring to [30-5 Performing setting of the production control information, p.117](#).

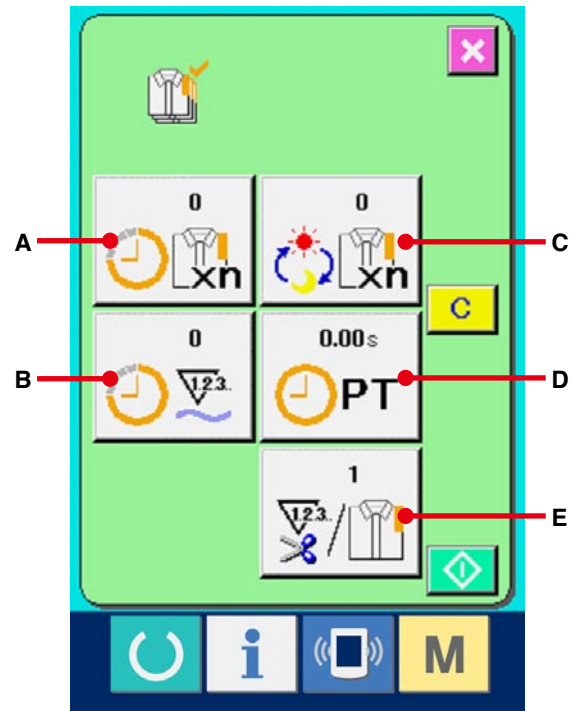

30-4-2 When displaying from the sewing screen

① **Display the sewing screen.**

When READY key  (A) of the switch seat section is pressed in the data input screen, the sewing screen is displayed.

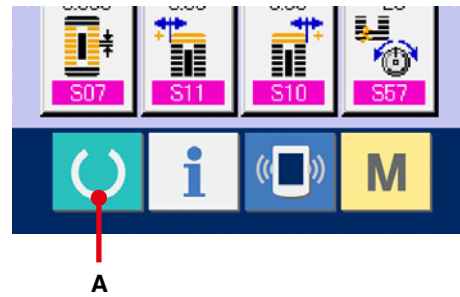

② **Display the production control screen.**

When information key  (B) of the switch seat section is pressed in the sewing screen, the production control screen is displayed.

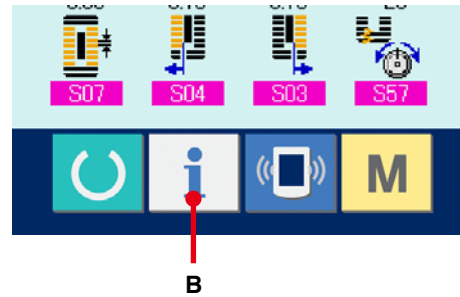

The contents of display and the functions are common to [30-4-1 When displaying from the information screen, p.114](#).

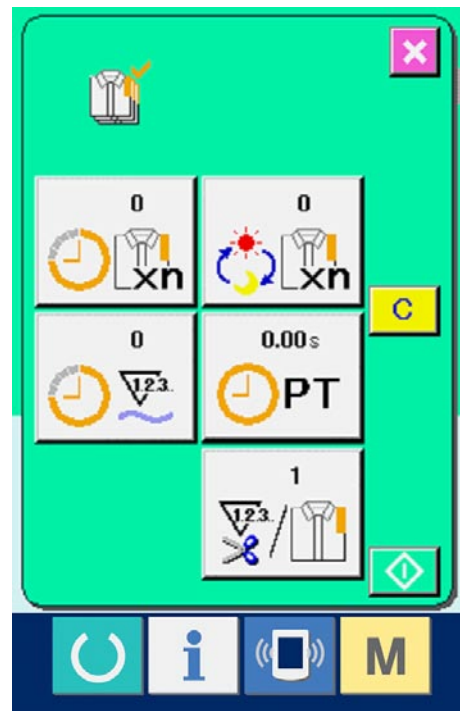

30-5 Performing setting of the production control information

① **Display the production control screen.**

Display the production control screen referring to [30-4 Observing the production control information](#), p.114.

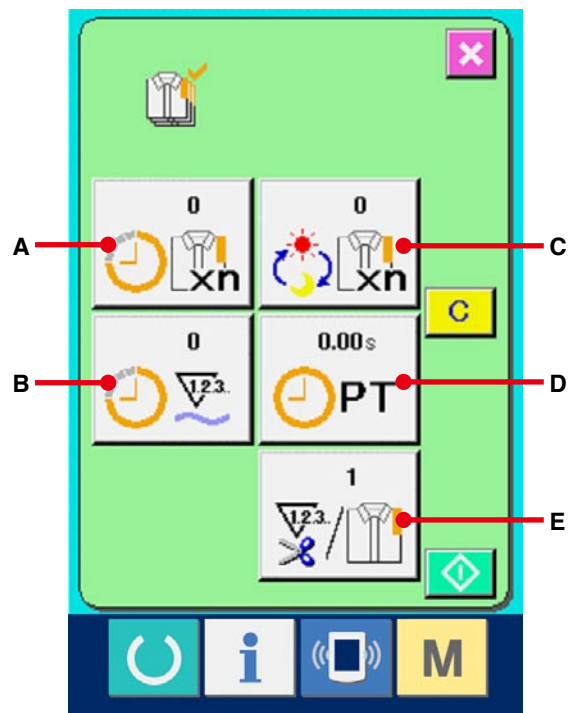

② **Input the final target value.**

First, input the number of pieces of the target of production in the process to which sewing is performed from now on. When final target value button  (C) is pressed, the final target value input screen is displayed.

Input the value you desire with ten keys or UP/DOWN buttons.

After the input, press ENTER button  (F).

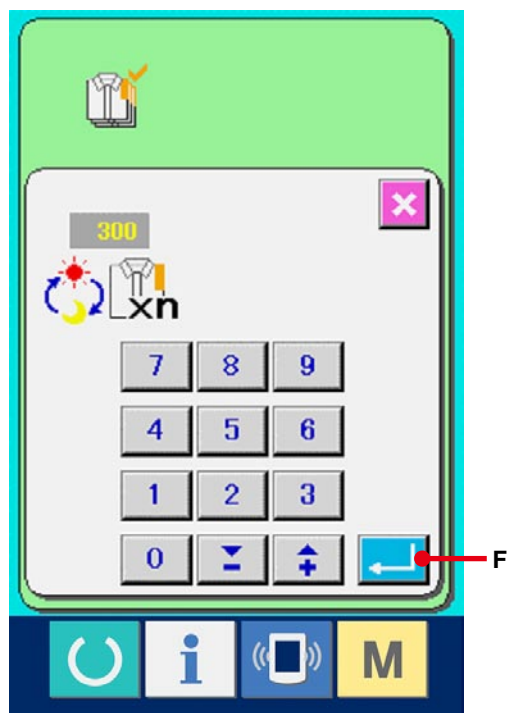

③ **Input the pitch time.**

Next, input the pitch time required for one process.

When pitch time button  (D) in the previous page is pressed, the pitch time input screen is displayed.

Input the value you desire with ten keys or UP/ DOWN buttons.

After the input, press ENTER button  (F).

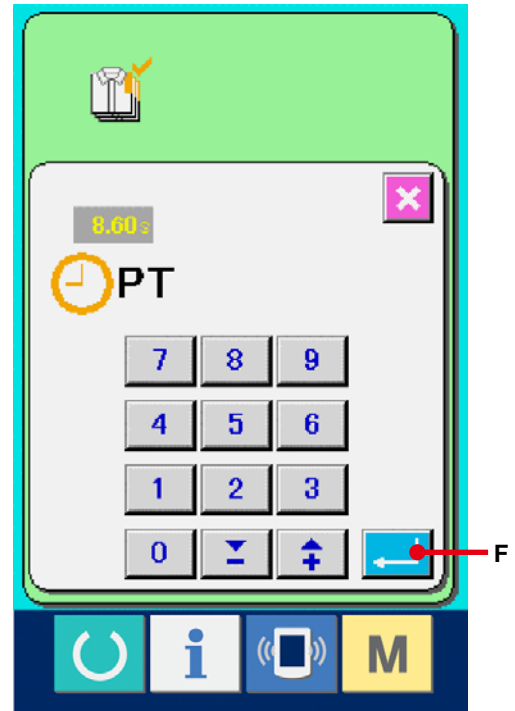

④ **Input the number of times of thread trimming.**

Next, input the number of times of thread trimming per process.

When number of times of thread trimming button  (E) in the previous page is pressed, the number of times of thread trimming input screen is displayed.

Input the value you desire with ten keys or UP/ DOWN buttons.

After the input, press ENTER button  (F).

* When the input value is "0", count of the number of times of thread trimming is not performed. Use this function by connecting the external switch.

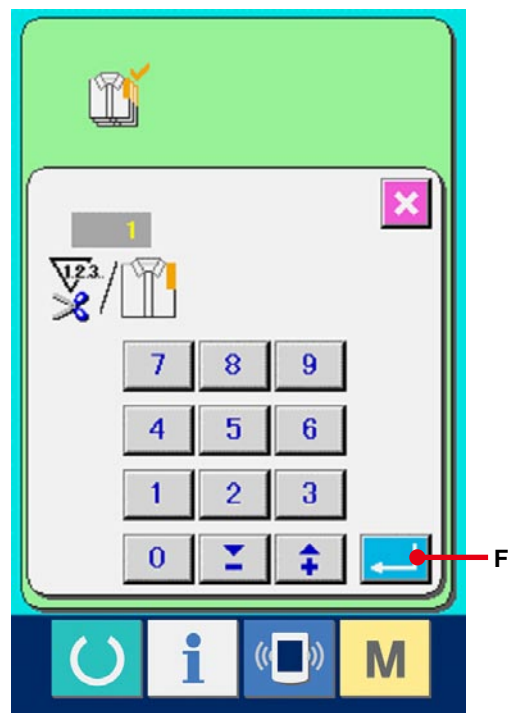

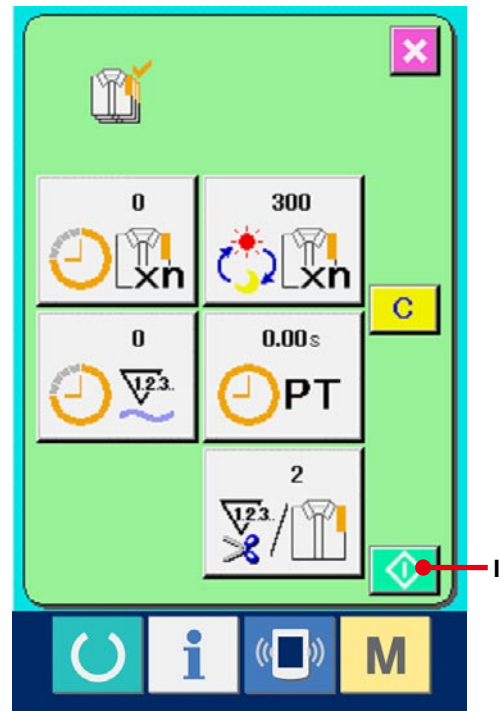

⑤ **Start the count of number of pieces of production.**

When START button  (I) is pressed, the count of number of pieces of production is started.



⑥ **Stop the count.**

Display the production control screen referring to [30-4 Observing the production control information, p.114](#).

When the count is being performed, STOP button  (J) is displayed. When STOP button  (J) is pressed, the count is stopped.

After the stop, START button is displayed at the position of STOP button. When continuing the count, press START button again. The counted value is not cleared until CLEAR button is pressed.

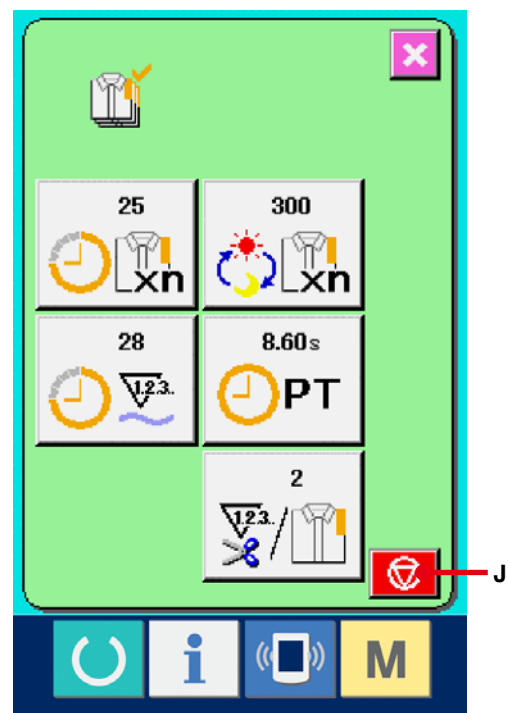

⑦ **Clear the counted value.**

When clearing the counted value, set the count to the stop state and press CLEAR button **C** (K).

The value to be cleared is the present target value (L) and actual results value (M) only.

(Note : CLEAR button is displayed only in case of stop state.)

When CLEAR button is pressed, the clear confirmation screen is displayed.

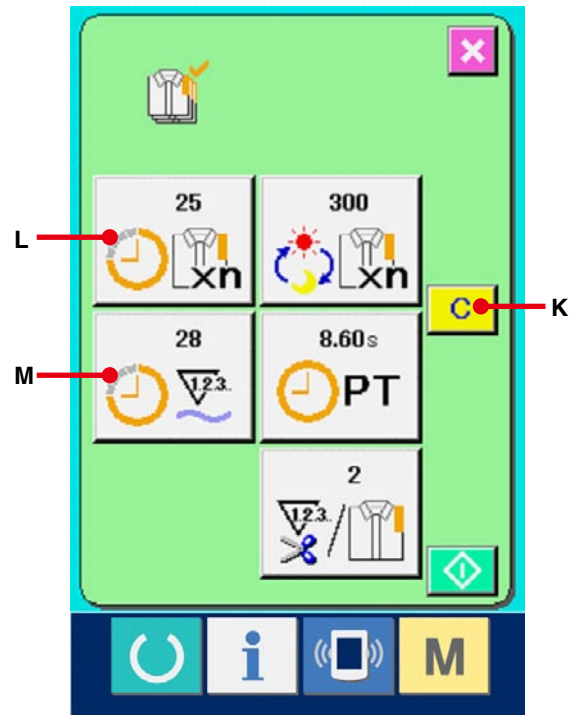

When CLEAR button **C** (N) is pressed in the clear confirmation screen. the counted value is cleared.

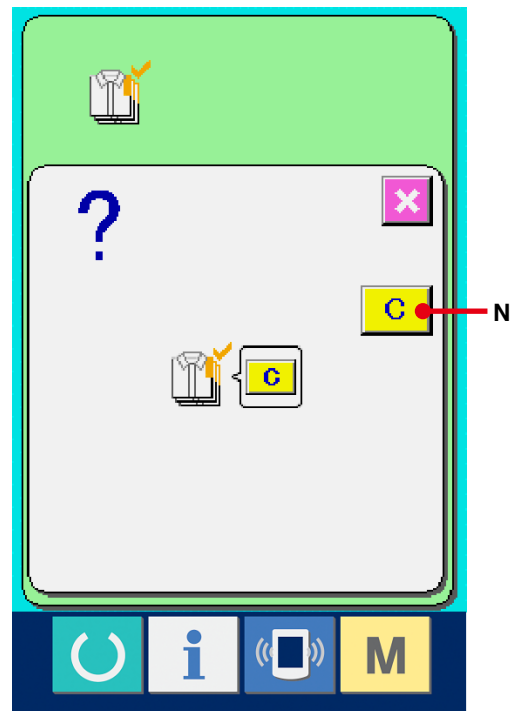

30-6 Observing the working measurement information

① **Display the information screen.**

When information key  (A) of the switch seat section is pressed in the data input screen, the information screen is displayed.

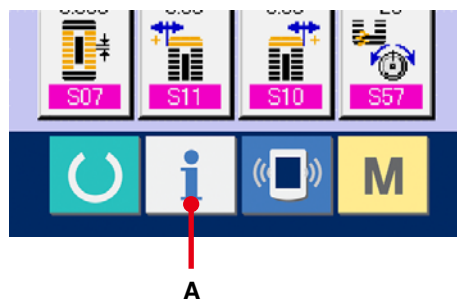

② **Display the working measurement screen.**

Press working measurement screen display button  (B) in the information screen. The working measurement screen is displayed.

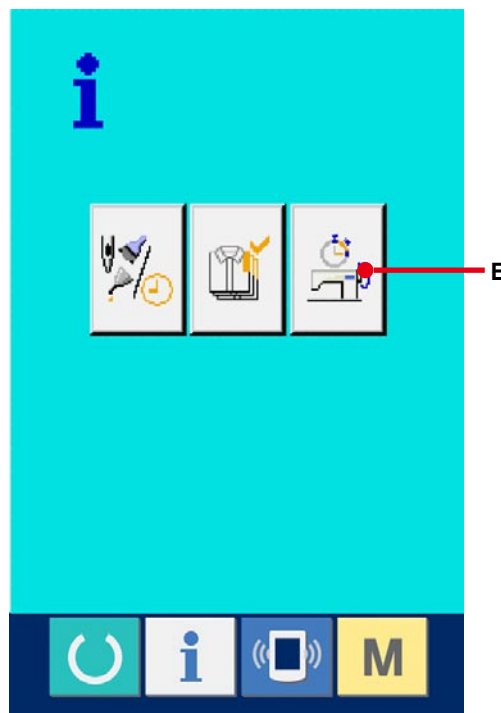

Information on the following 5 items are displayed in the working measurement screen.

- A : The information is automatically displayed from the time of start of measuring the working ratio.
- B : The information is automatically displayed from the time of start of measuring the machine speed.
- C : The information is automatically displayed from the time of start of measuring the pitch time.
- D : The information is automatically displayed from the time of start of measuring the machine time.
- E : Number of times of thread trimming is displayed.
Input the number of times referring to the next ③

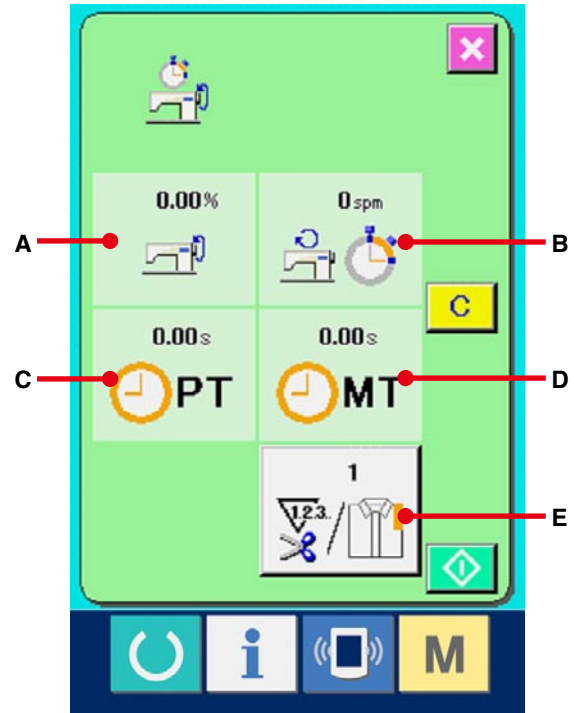

③ **Input the number of times of thread trimming.**

Next, input the number of times of thread trimming per process. When number of times of thread trimming button  (E) in the previous page is pressed, the number of times of thread trimming input screen is displayed.

Input the value you desire with ten keys or UP/DOWN buttons.

After the input, press ENTER button  (F).

- * When the input value is 0, count of the number of times of thread trimming is not performed. Use this function by connecting the external switch.

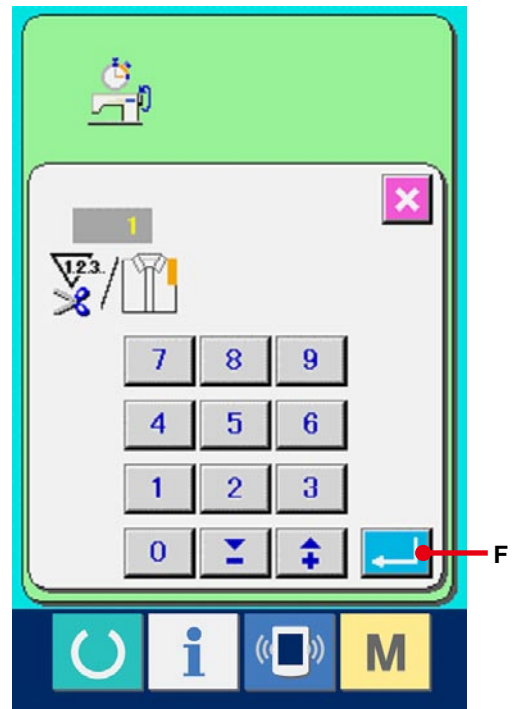

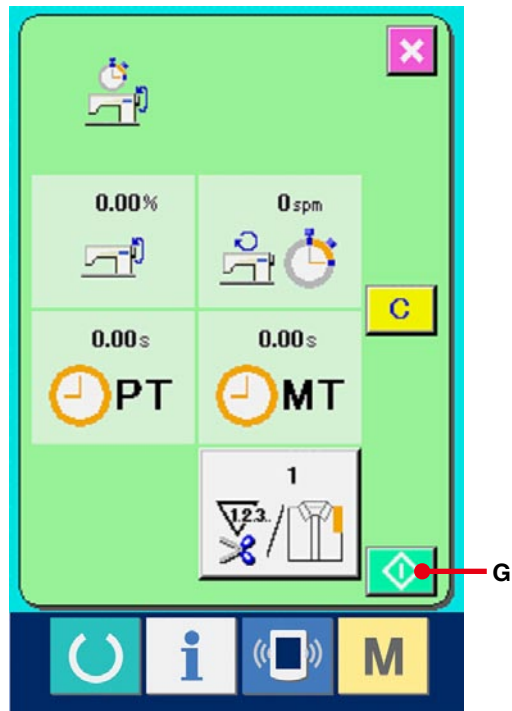

④ **Start the measurement.**

When START button  (G) is pressed, measurement of each data is started.



⑤ **Stop the count.**

Display the working measurement screen referring to ① and ② of [30-6 Observing the working measurement information, p.121](#).

STOP button  (H) is displayed when the measurement is being performed. When STOP button  (H) is pressed, the measurement is stopped.

After the stop, START button is displayed at the position of STOP button. To continue measuring, press START button again. The measured value is not cleared until CLEAR button is pressed.

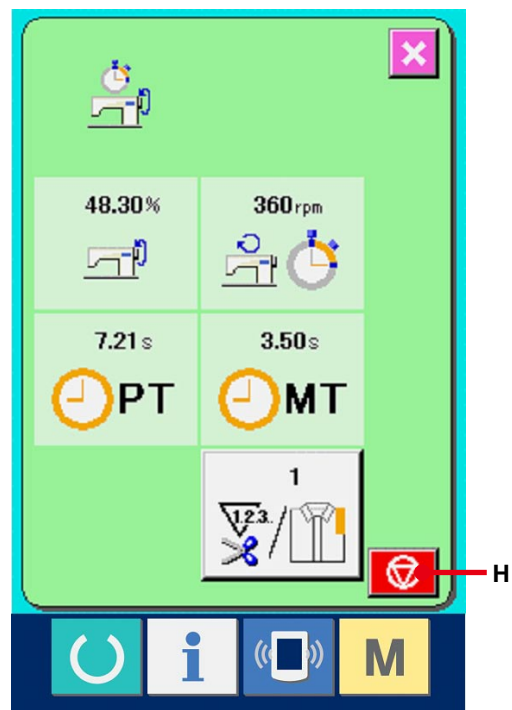

⑥ **Clear the counted value.**

When clearing the counted value, set the count to the stop state and press CLEAR button **C** (I).

(Note : CLEAR button is displayed in case of the stop state only.)

When CLEAR button is pressed, the clear confirmation screen is displayed.

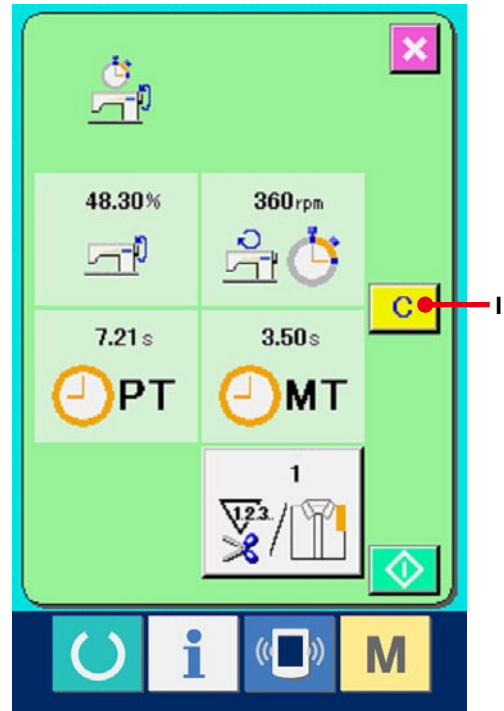

When CLEAR button **C** (J) is pressed in the clear confirmation screen, the counted value is cleared.

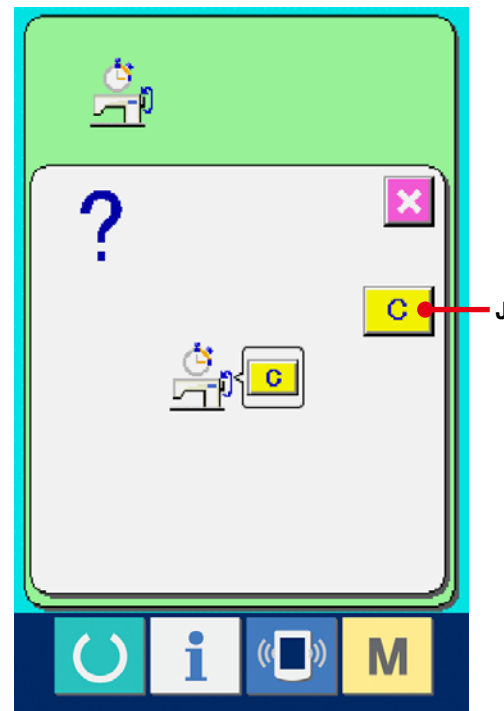

31. TRIAL SEWING FUNCTION

Data created with PM-1 (sewing data creation and edit software) can be sewn on trial by on-line connection of the personal computer with the sewing machine.

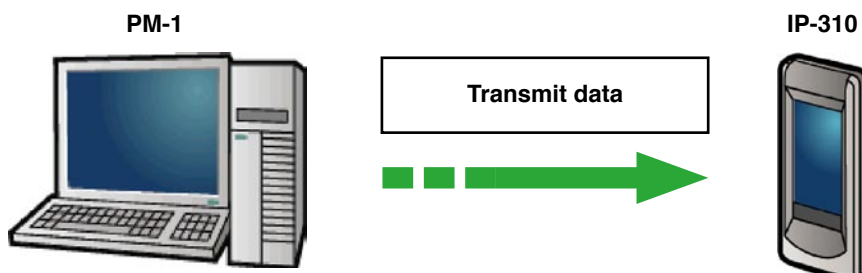

Connect the personal computer with IP-310 and transmit data to the sewing machine after creation of data with PM-1.

When IP-310 becomes the data input screen, automatically the trial sewing screen is displayed. For the operating procedure of PM-1, see HELP of PM-1 or the like.

31-1 Performing trial sewing

① Receive the trial sewing data from PM-1.

When the trial sewing data (vector format data) is transmitted from PM-1, the screen on the right side is displayed, and the needle entry diagram of the transmitted data is displayed in the center of the screen. The display color of the needle entry diagram is different according to the thread tension value. When the number of stitches of the transmitted data is excessive, the needle entry diagram is not displayed.

② Edit the vector parameter.

Sewing can be performed by adding the vector parameter which can be set by the sewing machine to the vector format data transmitted from PM-1.

When sewing data setting button  (A) is pressed, the vector parameter edit screen is displayed. When setting is not performed, the vector parameter becomes the initial value.

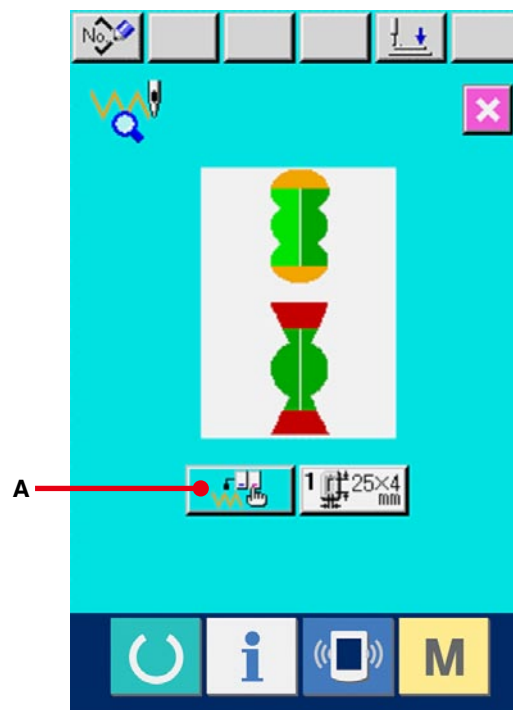

③ **Select the vector parameter to be changed.**

Press UP/DOWN scroll button and select the parameter item you desire to change.

④ **Change the data.**

There are data item to change numerals and that to select pictographs in the sewing data. NO. in pink color such as **S03** is put on the data item to change numerals and the set value can be changed with buttons displayed in the change screen. NO. in blue color such as **S81** is put on the data item to select pictographs and the pictographs displayed in the change screen can be selected. For the details of sewing data, refer to [31-2 Vector parameter list, p.128](#).

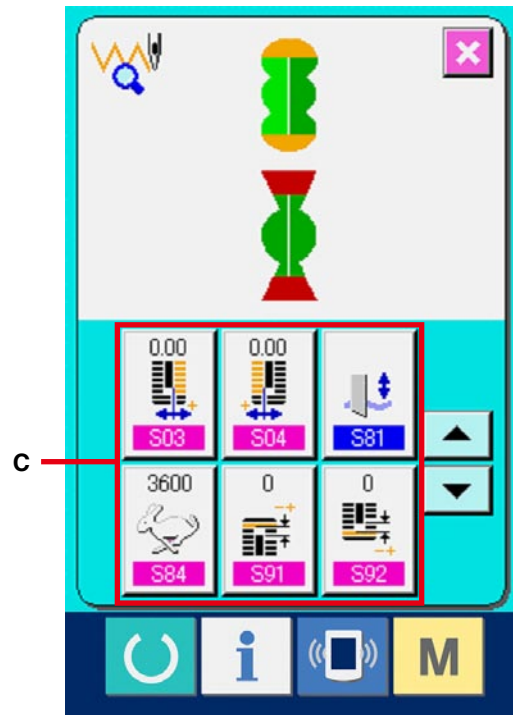

⑤ **Perform trial sewing.**

When READY switch  is pressed, the trial sewing screen is displayed.

Trial sewing can be performed in this state.

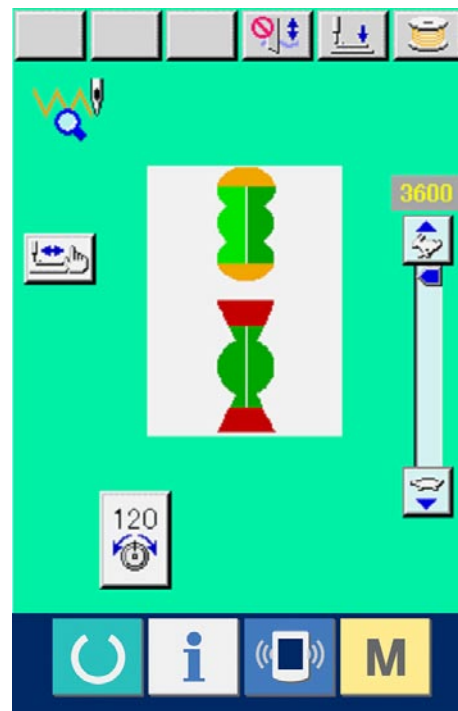

⑥ **Register the data to the pattern.**

When the data which has been sewn on trial is registered to the panel, press REGISTER button



(B) displayed in the trial sewing screen, and

the register screen is displayed.

Input the pattern No. you desire to register with ten keys (E).

⑦ **Determine the register of the data.**

When ENTER button  (F) is pressed, the register screen is closed and the register has been completed.

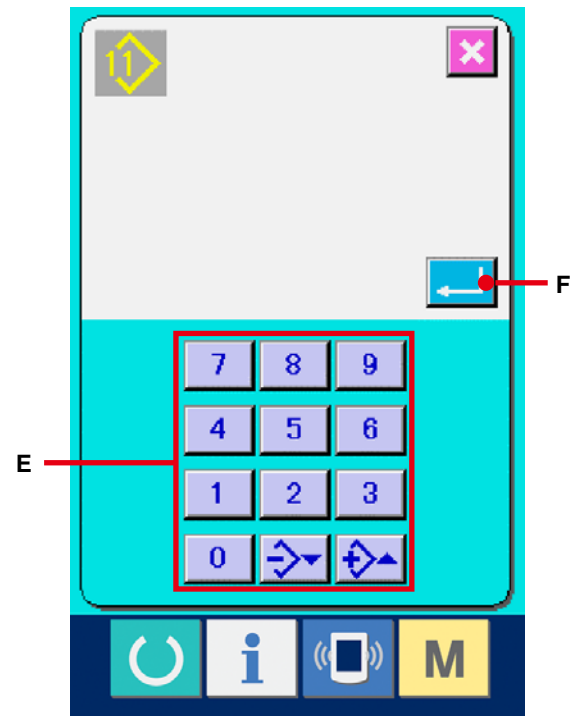

⑧ **Display the data input screen.**

After completion of the register, automatically the data input screen is displayed.

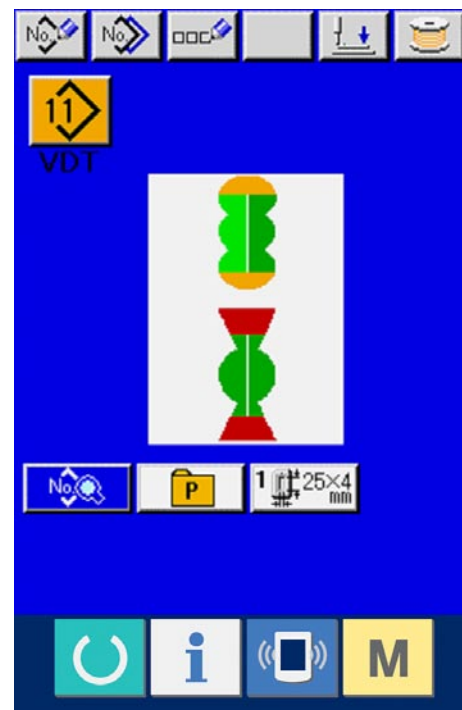











31-2 Vector parameter list

No.	Item		Setting range	Edit unit	Initial display
S03	Knife groove width, right		-2.00 to 2.00	0.05mm	0
S04	Knife groove width, left		-2.00 to 2.00	0.05mm	0
S81	With/without knife		0 to 1	---	0
S84	Max. speed limitation		400 to 4200	100rpm	---
S91	1st clearance compensation		-9 to 9	1 stitch	0
S92	2nd clearance compensation		-9 to 9	1 stitch	0
S93	Increase/decrease ratio (X direction)		20 to 200	1%	100
S94	Increase/decrease ratio (Y direction)		20 to 200	1%	100
S95	ACTIVE tension reference value		0 to 200	1	0

31-3 Thread tension value display color list

Needle entry diagram to be displayed is different according to the thread tension value which is set to the needle entry point. The color displayed according to the thread tension is as described below.

Thread tension value	Display color
0 to 20	 : Gray
21 to 40	 : Purple
41 to 60	 : Blue
61 to 80	 : Light blue
81 to 100	 : Green
101 to 120	 : Yellow green
121 to 140	 : Orange
141 to 160	 : Red
161 to 180	 : Pink
181 to 200	 : Black

32. PERFORMING KEY LOCK

① Display the key lock screen.

Press **M** key for three seconds, and the KEY

LOCK button  (A) is displayed on the screen.

When this button is pressed down, the key lock screen is displayed.

The existing setting state is displayed on the KEY LOCK button.





: State that key lock is not set

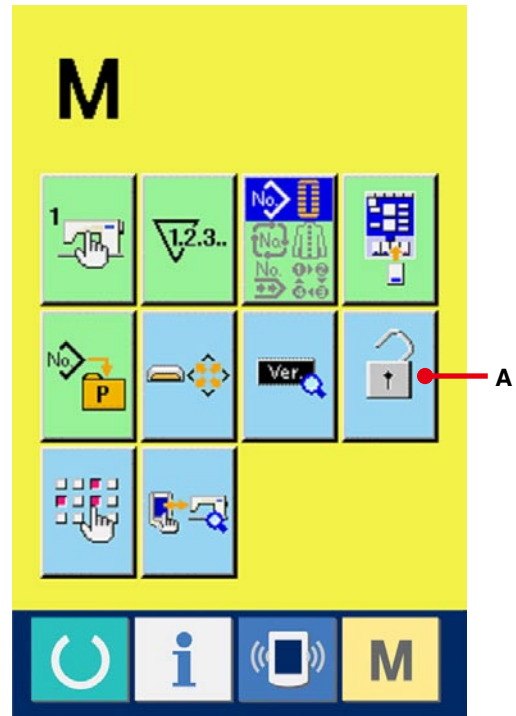

: State that key lock is set



② Select and determine the key lock state.

Select the key lock state button  (B) in the key lock setting screen, and press . Then the key lock setting screen is closed and the key lock state is set.

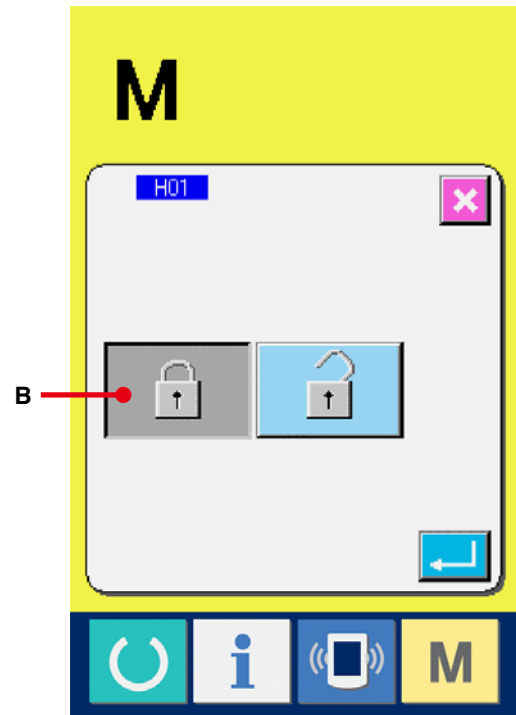

③ **Close the mode screen and display the data input screen.**

When the mode screen is closed and the data input screen is displayed, pictograph (C) showing the key lock state is displayed on the right-hand side of the pattern No. display.

Besides, only the buttons which are possible to be used even in the key lock state are displayed.

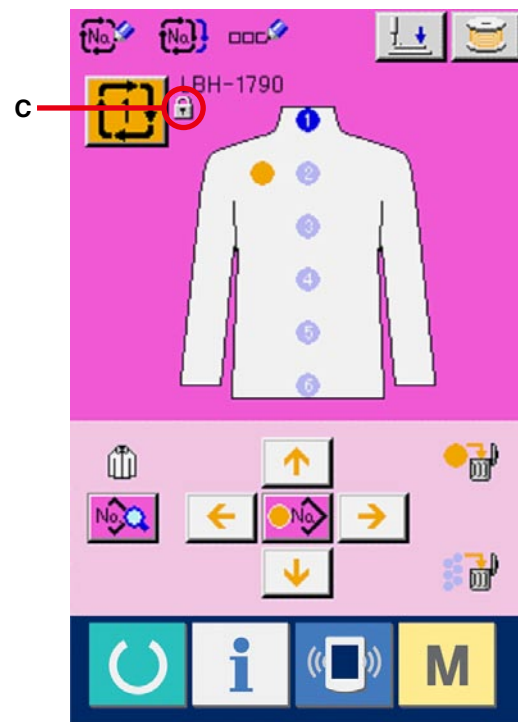

33. DISPLAYING VERSION INFORMATION

① **Display the version information screen.**

Press **M** key for three seconds, and the

VERSION INFORMATION button  (A) is

displayed on the screen. When this button is pressed down, the version information screen is displayed.

The version information on the sewing machine you use is displayed on the version information screen, and it is possible to check it.

B : Version information on panel program

C : Version information on main program

D : Version information on servo program

When CANCEL button  (E) is pressed, the version information screen is closed and the mode screen is displayed.

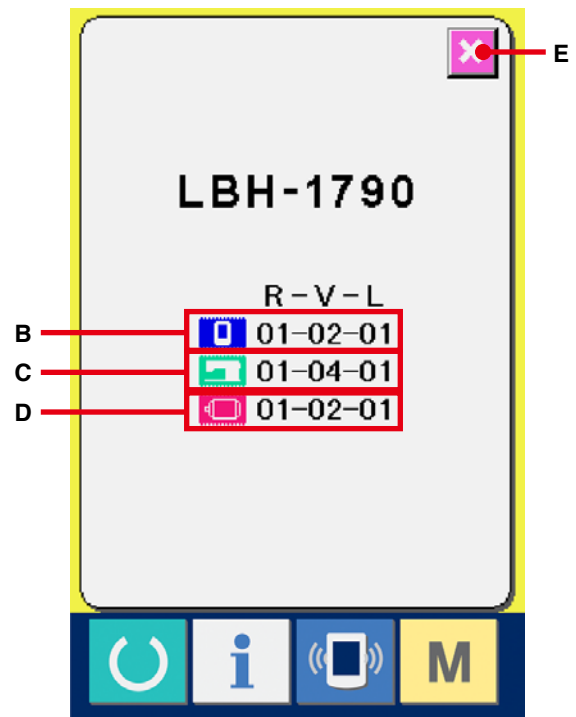
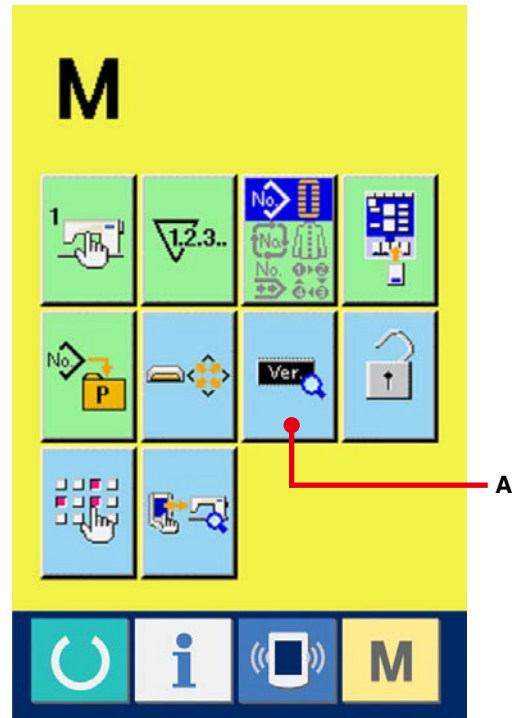

34. USING CHECK PROGRAM

34-1 Displaying the check program screen

Press **M** key for three seconds, and CHECK

PROGRAM button  (A) is displayed on the

screen.

When this button is pressed down, the check program screen is displayed.

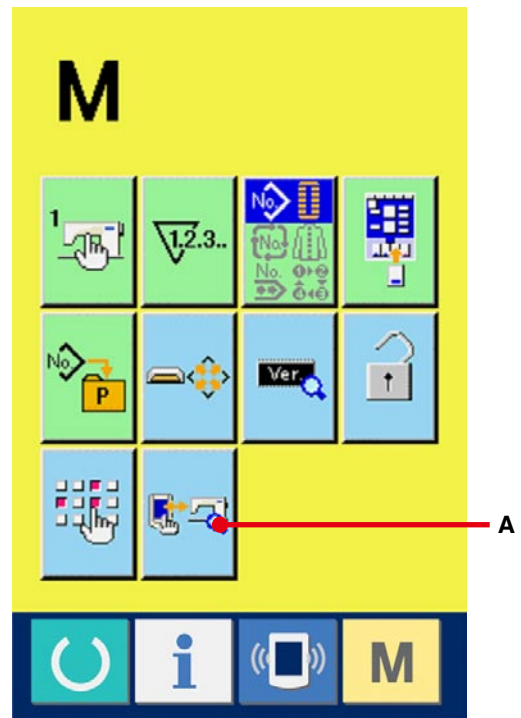

There are 5 items below in the check program.

I01 Needle thread trimmer origin adjustment
→ Refer to [34-2 Performing needle thread trimmer origin adjustment.p.135](#).

I02 Bobbin thread trimmer origin adjustment
→ Refer to [34-3 Performing bobbin thread trimmer origin adjustment.p.136](#).

I03 Sensor check
→ Refer to [34-4 Performing sensor check.p.137](#).

I04 LCD check
→ Refer to [34-5 Performing LCD check.p.139](#).

I05 Touch panel compensation
→ Refer to [34-6 Performing touch panel compensation.p.140](#).

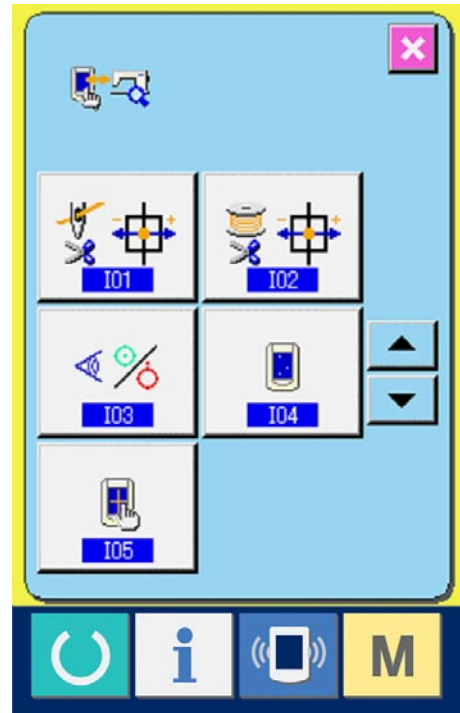

34-2 Performing needle thread trimmer origin adjustment

① Display the needle thread trimmer origin adjustment screen.

When NEEDLE THREAD TRIMMER ORIGIN ADJUSTMENT button  (A) on the check program screen is pressed, the needle thread trimmer origin adjustment screen is displayed.

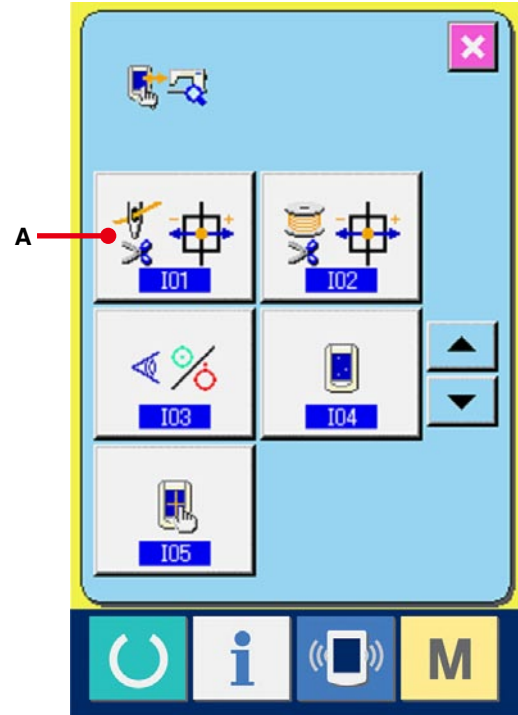

② Perform the needle thread trimmer origin adjustment.



When OPERATION button  (B) is pressed, the needle thread trimmer is actuated to the positions below and the pictograph showing the position is displayed in gray.

C : Thread holding position
(Initial value : 0 pulse)

D : Release position (Initial value : -86 pulses)

E : Waiting position (Initial value : 10 pulses)

F : Thread trimming position
(Initial value : 40 pulses)

Data of the respective positions can be changed with - or + button  or  (G or H).

When ORIGIN RETRIEVAL button  (I) is pressed, the origin retrieval can be performed from any position.

When CANCEL button  (J) is pressed, the contents of change can be memorized in EEPROM of the machine head and the screen returns to the check program screen.

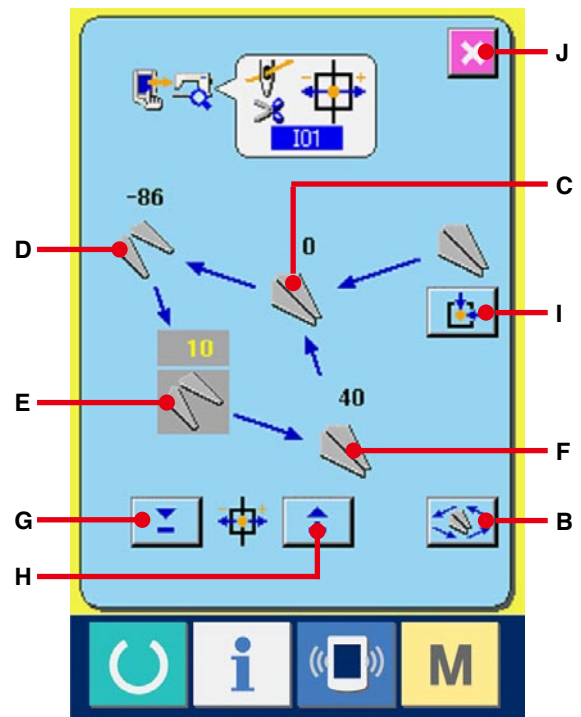

* For the details of adjustment, refer to the Engineer's Manual for LBH-1790.

34-3 Performing bobbin thread trimmer origin adjustment

① **Display the bobbin thread trimmer origin adjustment screen.**

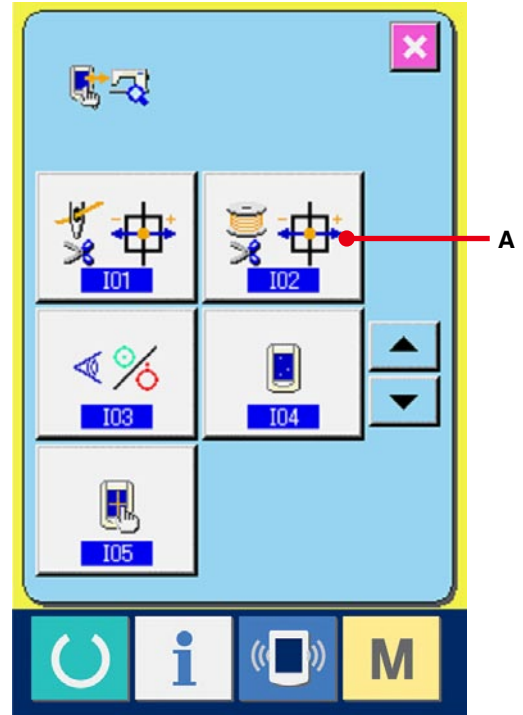

When BOBBIN THREAD TRIMMER ORIGIN ADJUSTMENT button  (A) on the check program screen is pressed, the bobbin thread trimmer adjustment screen is displayed.





② **Perform the bobbin thread trimmer origin adjustment.**

When OPERATION button  (B) is pressed, the bobbin thread trimmer is actuated to the positions below and the pictograph showing the position is displayed in gray.

- C : Release position (Initial value : -22 pulses)
- D : Waiting position (Initial value : 0 pulse)
- E : Thread trimming position (Initial value : 50 pulses)
- F : Thread holding position (Initial value : 0 pulse)

Data of the respective positions can be changed with - or + button  or  (G or H).

When ORIGIN RETRIEVAL button  (I) is pressed, the origin retrieval can be performed from any position.

When CANCEL button  (J) is pressed, the contents of change can be memorized in EEPROM of the machine head and the screen returns to the check program screen.

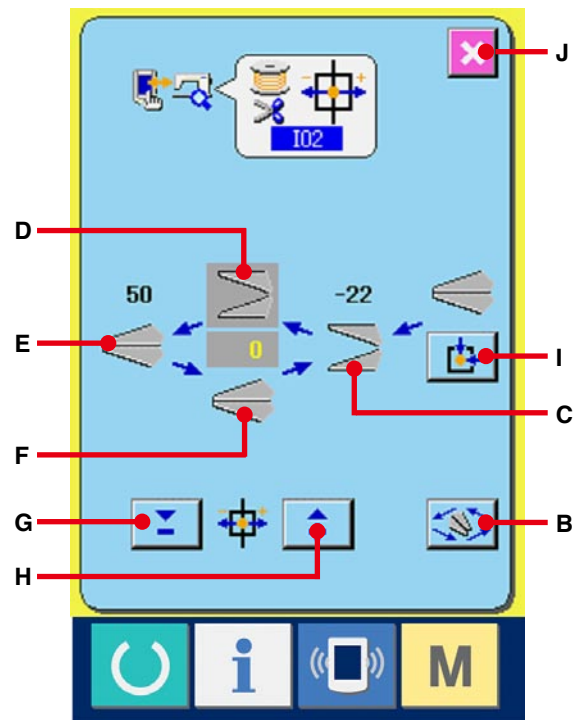

* For the details of adjustment, refer to the Engineer's Manual for LBH-1790.

34-4 Performing sensor check



① **Display the sensor check screen.**

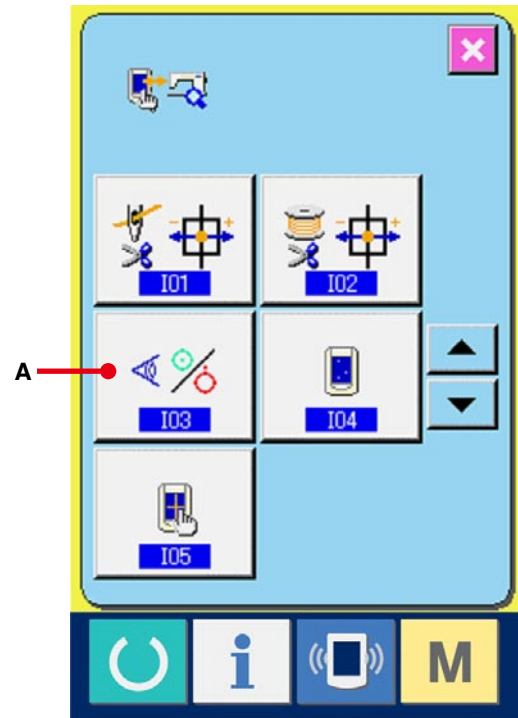

When SENSOR CHECK button  (A) on the check program screen is pressed, the sensor check screen is displayed.



② **Perform the sensor check.**







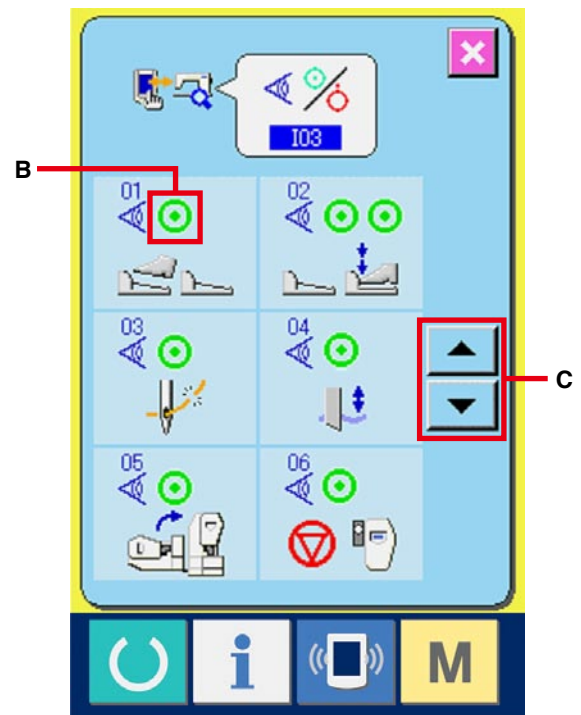







Input status of the various sensors can be checked on the sensor check screen.
 Input status of each sensor is displayed as (B).
 The display of ON status/OFF status is displayed as below.

-  : ON status
-  : OFF status

Press UP or DOWN button  or  (C) and display the sensor which has been checked.

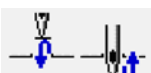

8 kinds of sensors below are displayed.

No.	Pictograph	Description of sensor
01 		Pedal variable resistor
02 		Pedal sensor
03 		Thread breakage detection
04 		Cloth cutting knife sensor
05 		Head tilt sensor
06 		Stop switch
07 		Needle rocking sensor
08 		Sewing machine woodruff plate sensor

34-5 Performing LCD check

① **Display the LCD check screen.**

When LCD CHECK button  (A) on the check program screen is pressed, the LCD check screen is displayed.

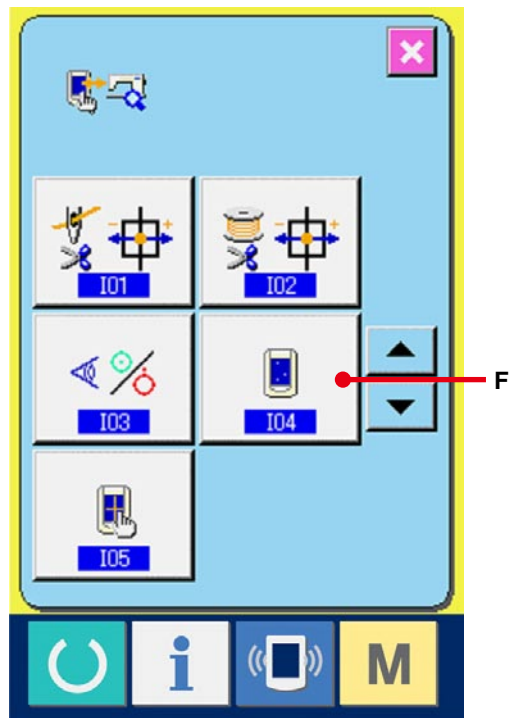

② **Check whether any dot of LCD is omitted.**

The screen of LCD check screen is displayed by one color only. Check in this state whether any dot is omitted or not.

After checking, press a proper place on the screen. The LCD check screen is closed and the check program screen is displayed.



34-6 Performing touch panel compensation

① **Display the touch panel compensation screen.**

When TOUCH PANEL COMPENSATION button



(A) on the check program screen is

pressed, the touch panel compensation screen is displayed.

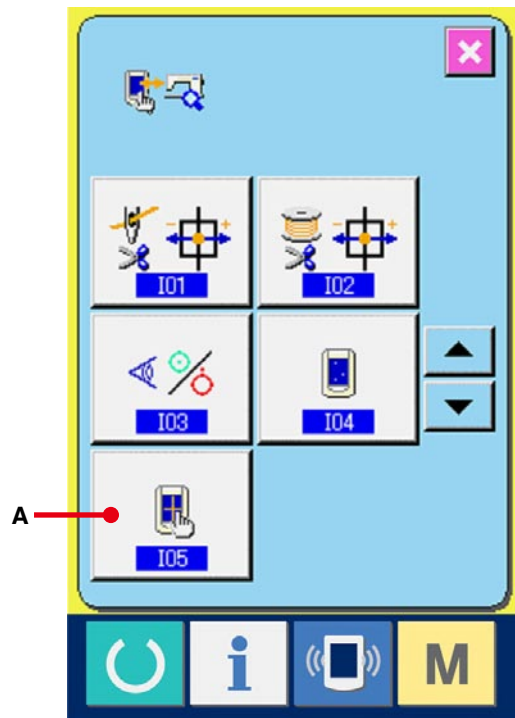

② **Press the lower left position.**

Press red circle (C) located at the lower left position on the screen.

When finishing the compensation, press CANCEL

button (B).

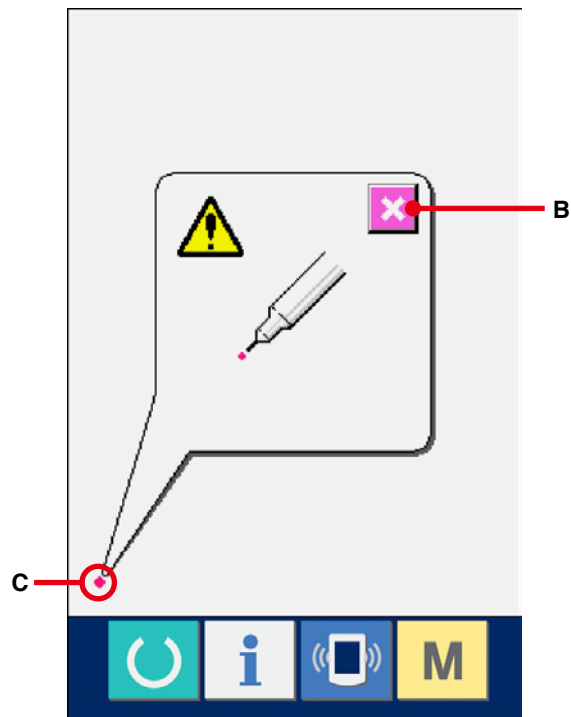

③ **Press the lower right position.**

Press red circle  (D) located at the lower right position on the screen.

When finishing the compensation, press CANCEL button  (B).

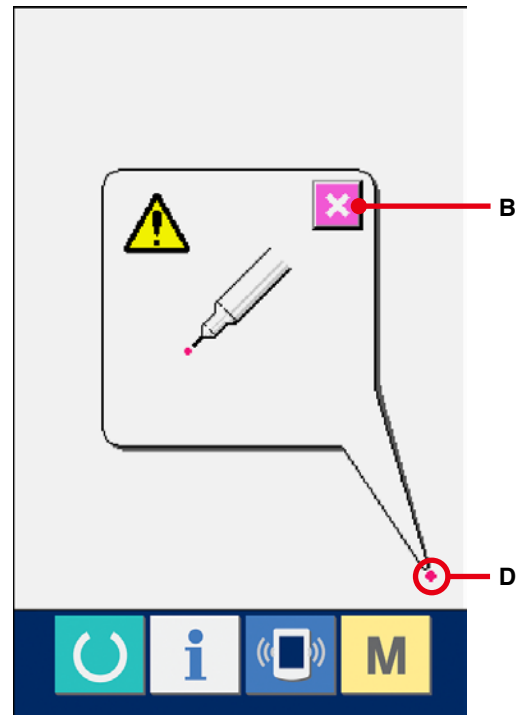

④ **Press the upper left position.**

Press red circle  (E) located at the upper left position on the screen.

When finishing the compensation, press CANCEL button  (B).

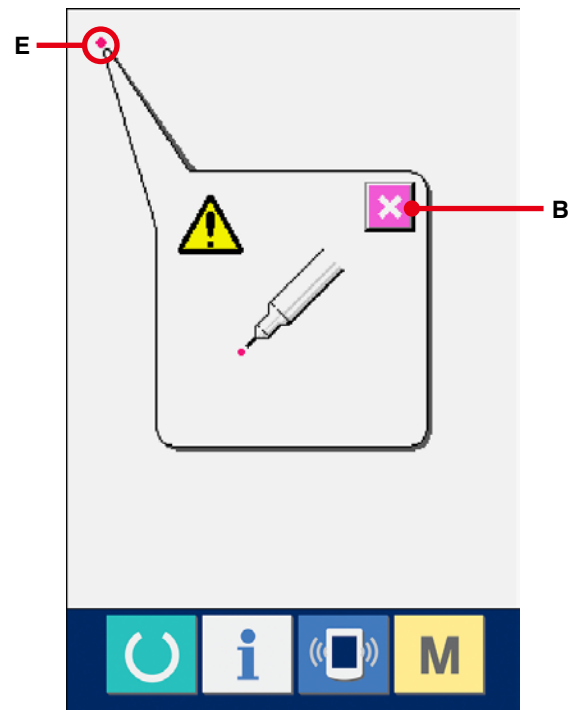

⑤ **Press the upper right position.**

Press red circle  (F) located at the upper right position on the screen.

When finishing the compensation, press CANCEL button  (B).

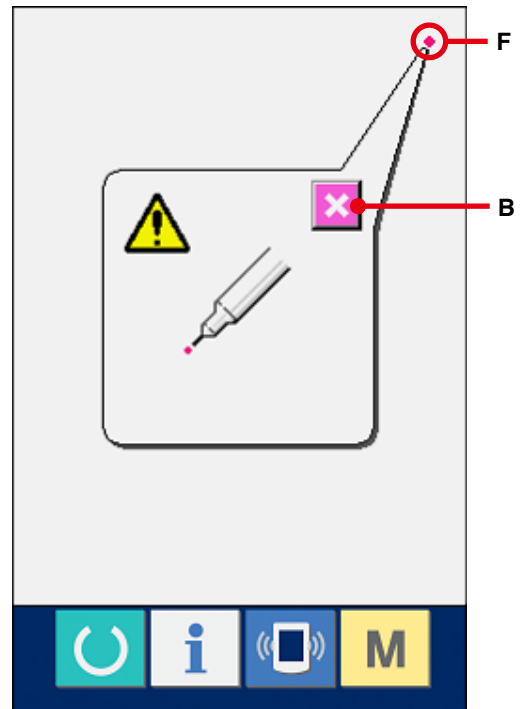

⑥ **Store the data.**

When 4 points have been pressed, the screen showing power-OFF prohibition is displayed since the compensation data are to be stored.

Do not turn OFF the power while this screen is being displayed.

When the power is turned OFF, the compensated data are not stored.

When storing is finished, the check program screen is automatically displayed.

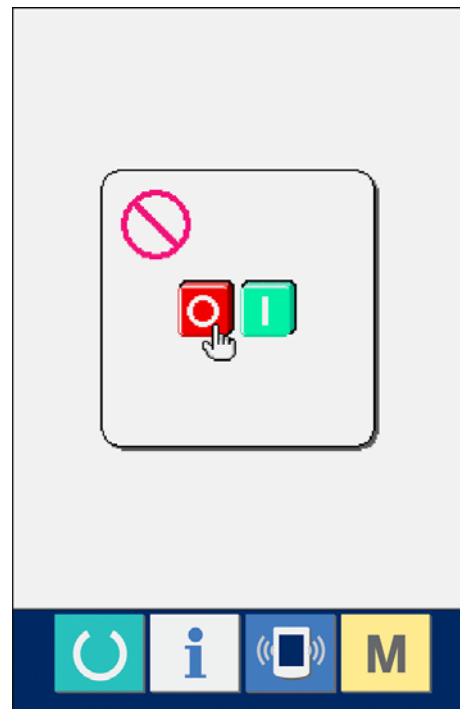





35. COMMUNICATION SCREEN OF MAINTENANCE PERSONNEL LEVEL

For the communication screen, the level which is normally used and the one which is used by the maintenance personnel are different in the kinds of data to be handled.

35-1 Data which are possible to be handled

In case of the maintenance personnel level, it is possible to use 5 different kinds of data in addition to the normal two kinds.

The respective data formats are as below.

Data name		Extension	Description of data
Adjustment data		Model name+00xxx.MSW Example) LBH00001.MSW	Data of memory switches 1 and 2
All sewing machine data		Model name+00xxx.MSP Example) LBH00001.MSP	All data which are held by sewing machine
Panel program data (*)		IP+RVL(6 digits).PRG IM+RVL(6 digits).BHD	Program data and display data of panel
Main program data (*)		MA+RVL(6 digits).PRG	Program data of main
Servo program data (*)		MT+RVL(6 digits).PRG	Program data of servo

xxx: File No.

* For panel program data, main program data and servo program data, refer to the Set-up Manual for IP-310.

35-2 Displaying maintenance personnel level

① Display the communication screen of the maintenance personnel level.

When key  (A) is pressed as long as three seconds, the image located at the upper left position is changed to orange color (B) and the communication screen of the maintenance personnel level is displayed.

For the operating procedure, refer to [29-4 Take-in of the data.p.104](#).

- * When the adjustment data or the all sewing machine data is selected, the display becomes as shown on the right-hand side and it is not necessary to specify No. on the panel side.

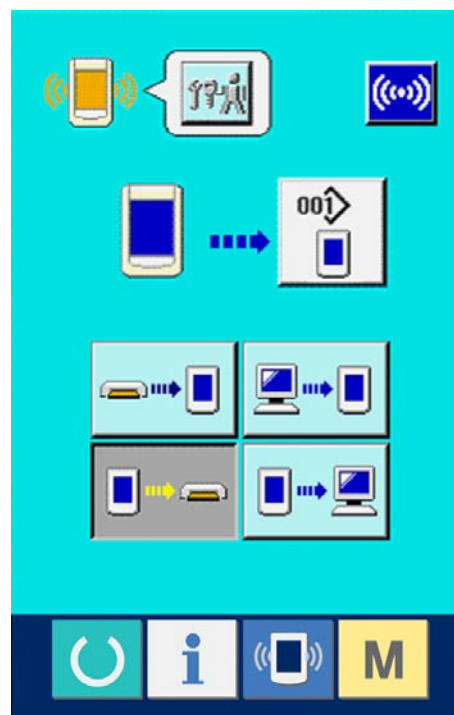

36. INFORMATION SCREEN OF THE MAINTENANCE PERSONNEL LEVEL

36-1 Display of error record

- ① **Display the information screen of the maintenance personnel level.**

When INFORMATION key  (A) of switch seat section is pressed for approximately three seconds in the data input screen, the information screen of the maintenance personnel level is displayed. In case of the maintenance personnel level, the pictograph located at the upper left position changes from blue color to orange color, and 5 buttons are displayed.

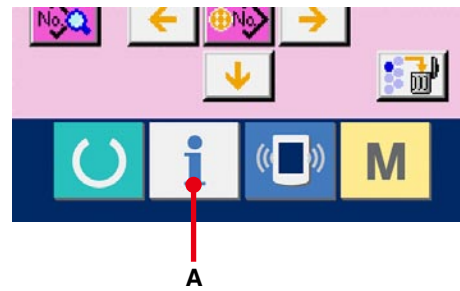

- ② **Display the error record screen.**

Press ERROR RECORD SCREEN DISPLAY button  (B) in the information screen. The error record screen is displayed.

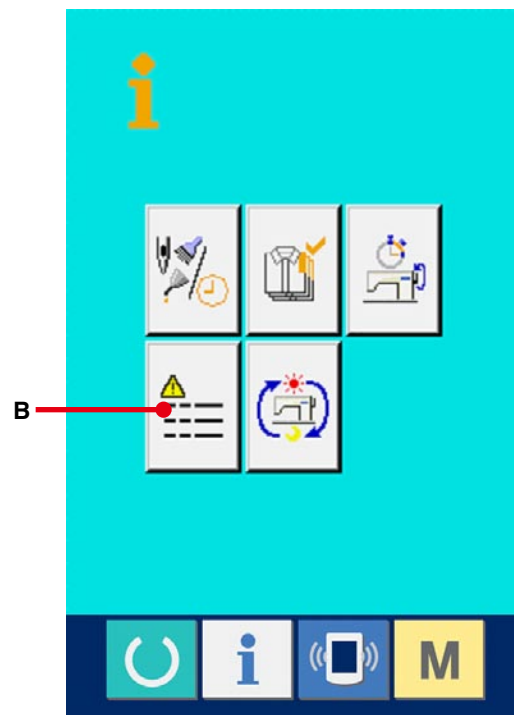

Error record of the sewing machine you use is displayed in the error record screen, and you can check the error.

C : Order that error has occurred.

D : Error code

E : Cumulative current-carrying time (hour) at the time of occurrence of error

When CANCEL button  (G) is pressed, the error record screen is closed and the information screen is displayed.

③ **Display the details of error.**

When you desire to know the details of error, press ERROR button  (F) you desire to know. The error detail screen is displayed.

Pictograph (H) corresponding to the error code is displayed in the error detail screen.

→ Refer to [28. ERROR CODE LIST,p.89.](#)

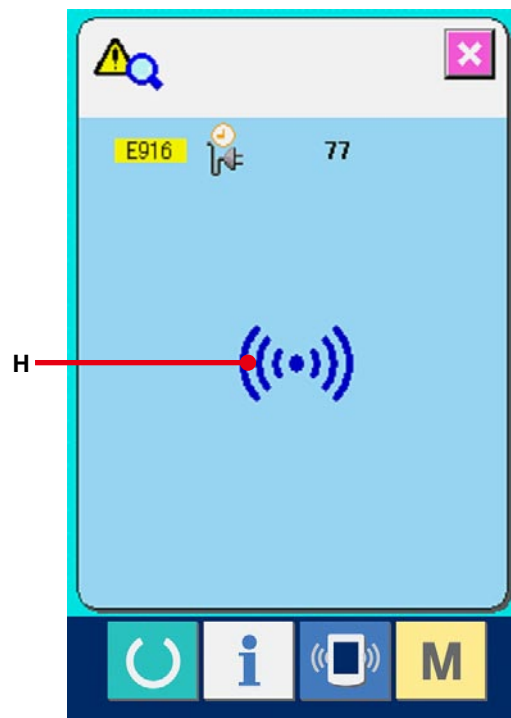
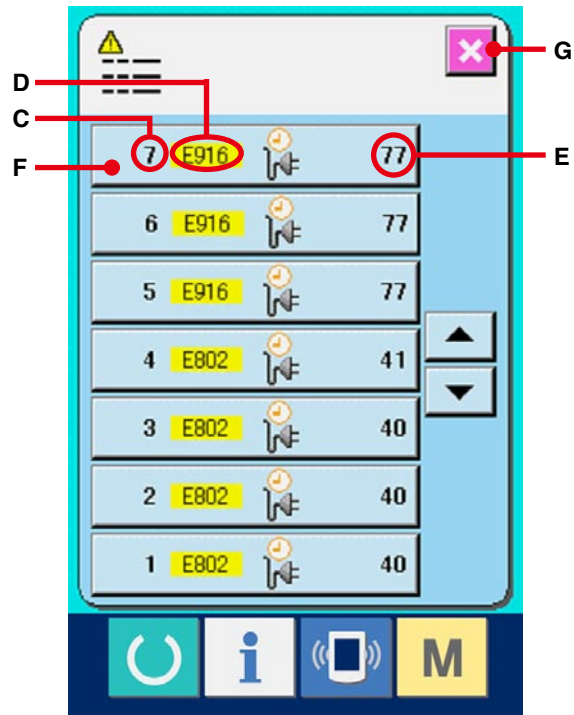

36-2 Display of the cumulative working information

① Display the information screen of the maintenance personnel level.

When INFORMATION key  of switch seat section is pressed for approximately three seconds in the data input screen, the information screen of the maintenance personnel level is displayed. In case of the maintenance personnel level, the pictograph located at the upper left position changes from blue color to orange color, and 5 buttons are displayed.

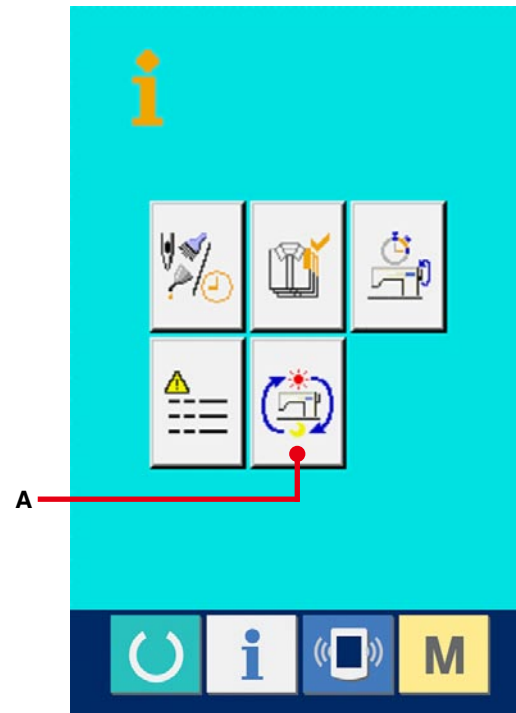

② Display the cumulative working information screen.

Press CUMULATIVE WORKING INFORMATION SCREEN DISPLAY button  (A) of the information screen. The cumulative working information screen is displayed.

Information on the following 4 items are displayed in the cumulative working information screen.

B : Cumulative working time (hour) of the sewing machine is displayed.

C : Number of cumulative times of thread trimming is displayed.

D : Cumulative current-carrying time (hour) of the sewing machine is displayed.

E : Number of cumulative stitches is displayed.
(Unit : X1,000 stitches)

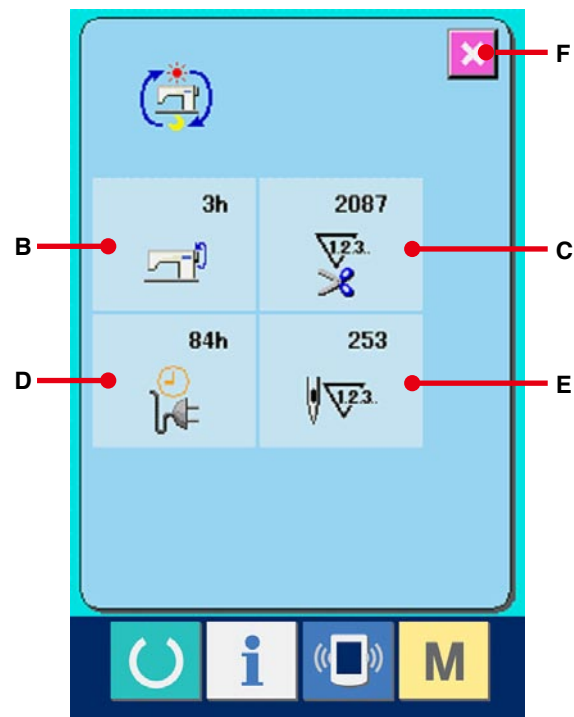

When CANCEL button  (F) is pressed, the cumulative working information screen is closed and the information screen is displayed.

"CompactFlash(TM)" is the registered trademark of SanDisk Corporation, U.S.A.