

ENGLISH

**DDL-9000C-F
INSTRUCTION MANUAL**

CONTENTS

1. SPECIFICATIONS	1
1-1. Specifications of the sewing machine head	1
1-2. Specifications of the control box.....	1
2. SET UP	2
2-1. Drawing of table.....	2
2-2. Cautions when setting up the sewing machine.....	3
2-2-1. How to carry the sewing machine	3
2-2-2. Caution when placing the sewing machine.....	3
2-3. Installation.....	3
2-4. Installing the thread stand.....	4
2-5. Installing the electrical box	5
2-6. Connecting the power switch cable	5
2-6-1. Installing the power switch	5
2-6-2. Connecting the power source cord.....	6
2-6-3. Installing the reactor box	7
2-7. Connecting the cords.....	8
2-8. Handling the cords	9
2-9. Attaching the connecting rod.....	9
2-10. Adjustment of the pedal.....	10
2-10-1. Installing the connecting rod.....	10
2-10-2. Adjusting the pedal angle	10
2-11. Pedal operation.....	10
2-12. Lubrication (DDL-9000C-FMS, FSH)	11
2-13. How to use the operation panel (Basic explanation)	12
2-13-1. Selection of the language (operation to be done at first)	12
2-13-2. Names and functions of the panel keys	14
2-13-3. Basic operation	15
3. PREPARATION BEFORE SEWING	16
3-1. Attaching the needle	16
3-2. Removing/fitting the bobbin case.....	16
3-3. Winding the bobbin thread	17
3-4. Threading the machine head.....	19
3-5. Thread tension.....	20
3-5-1. Adjusting the thread tension No. 1 tension.....	20
3-5-2. Adjusting the needle thread tension (Active tension).....	20
3-5-3. Tension correction (with respect to the bobbin thread remaining amount)	21
3-5-4. Adjusting the bobbin thread tension	22
3-6. Presser foot (Active presser device)	23
3-6-2. Micro-lifter function	23
3-6-1. Presser foot pressure.....	23
3-6-3. Changing the initial value of presser foot pressure	24
3-6-4. Manual lifter.....	24
3-7. Adjusting the stitch length	25
3-8. Changing the sewing speed	25
3-9. LED hand light	26
3-10. Reverse feed stitching	26

3-11. Custom switch	27
3-12. Adjusting the amount of oil (oil splashes) in the hook (DDL-9000C-FMS, FSH)	28
3-12-1. Adjusting the amount of oil in the hook	28
3-12-2. How to confirm the amount of oil (oil splashes).....	29
3-12-3. Sample showing the appropriate amount of oil.....	29
3-13. Adjusting the thread take-up spring and the thread take-up stroke.....	30
4. HOW TO USE THE OPERATION PANEL	31
4-1. Explanation of the sewing screen (when selecting a sewing pattern).....	31
4-2. Sewing patterns.....	35
4-2-1. Sewing pattern configuration	35
4-2-2. List of sewing patterns.....	36
4-2-3. Reverse feed stitching (at start) pattern	38
4-2-4. Double reverse-feed stitch.....	43
4-2-5. Editing the sewing patterns	44
4-2-6. List of pattern functions.....	46
4-2-7. Reverse feed stitching (at end) pattern	49
4-2-8. Teaching function	50
4-2-9. One-touch utility changeover function	52
4-2-10. Registration of a new sewing pattern	53
4-2-11. Copying a pattern.....	55
4-2-12. Narrow-down function.....	56
4-3. Counter function.....	58
4-3-1. Displaying the sewing screen under the counter display mode	58
4-3-2. Types of the counter.....	58
4-3-3. How to set the counter	59
4-3-4. How to reset the count-completion state	62
4-4. Simplified chart of panel displays	63
4-5. List of memory switch data	64
4-6. List of errors	69
4-7. Memory switch data	73
5. MAIN NEW FUNCTIONS	75
5-1. Shorter-thread remaining thread trimming.....	75
5-2. Adjusting the feed dog height.....	78
5-3. Operating timing of the feed.....	79
5-4. Changing the feed locus.....	80
6. CARE	81
6-1. Maintenance mode	81
6-2. Confirmation of the amount of oil in the hook oil tank (DDL-9000C-FMS, FSH)	81
6-3. Cleaning the area around the hook	82
6-4. Cleaning the interior of the frame	83
6-5. Applying grease.....	84
6-6. Applying grease to the needle bar lower bushing and the presser bar bushing	84
6-7. Replacing the fuse.....	85
6-8. Disposal of batteries	86
7. ADJUSTMENT OF THE MACHINE HEAD (APPLICATION)	87
7-1. Needle-to-hook relationship	87
7-2. Adjusting the needle thread presser device	88
7-3. Adjusting the thread trimmer	91

7-3-1. For checking of the thread trimming cam timing	91
7-3-2. Adjustment of the thread trimming cam timing	91
7-3-3. Checking of the knife unit	92
7-3-4. Adjustment of the knife unit	93
7-3-5. Adjustment of thread trimming speed	94
7-4. Adjustment of the picker.....	95
7-4-1. Checking the standard adjustment	95
7-4-2. Standard adjustment	95
7-4-3. Standard adjustment (Adjustment at the tip position)	95
7-5. Active-presser multi-layered section detection function.....	96
7-5-1. Multi-layered section detection function	96
7-5-2. Multi-layered-section detection number of stitches setting function.....	98
7-6. Grease shortage alarm.....	99
7-6-1. Regarding the grease shortage alarm	99
7-6-2. E221 Grease-shortage error.....	99
7-6-3. Regarding K118 error resetting procedure.....	100
8. HOW TO USE THE OPERATION PANEL (APPLICATION).....	101
8-1. Management of sewing patterns	101
8-1-1. Creation of a new pattern.....	101
8-1-2. Copying a pattern	103
8-1-3. Deleting a pattern.....	104
8-2. Setting up the polygonal-shape stitching	105
8-2-1. Editing a polygonal-shape stitching pattern	105
8-2-2. Creating a new polygonal-shape stitching pattern.....	107
8-2-3. Setting the step from which polygonal-shape stitching is started	107
8-3. Cycle pattern.....	108
8-3-1. Selecting the cycle pattern	108
8-3-2. Editing cycle sewing data	109
8-3-3. Creating a new cycle pattern	110
8-3-4. Setting the step from which cycle sewing pattern is started	112
8-4. Custom pitch.....	113
8-4-1. Selecting a custom pitch.....	113
8-4-2. Creating a new custom pitch.....	115
8-4-3. Custom pitch edit function	118
8-4-4. Copying/deleting a custom pitch	119
8-5. Condensation custom pattern.....	120
8-5-1. Selecting the condensation custom	120
8-5-2. Creating a new condensation custom	120
8-5-3. Condensation custom edit function.....	123
8-5-4. Copying/deleting a condensation custom.....	124
8-6. Simple lock of the screen	125
8-7. Version information	125
8-8. Adjustment of brightness of the LED panel.....	126
8-9. Information.....	127
8-9-1. Data communication.....	127
8-9-2. USB	130
8-9-3. Production management.....	131
8-9-4. NFC.....	134
8-10. Key customization.....	135
8-10-1. Assignable data.....	135
8-10-2. How to assign a function to a key	136

1. SPECIFICATIONS

1-1. Specifications of the sewing machine head

DDL-9000C-F△△-△B

Face plate portion lubricating method

M	Semi-dry
S	Micro-quantity lubrication
D	Dry

Needle thread nipper specification

N	With
0	Without

Seam specification

S	Medium-weight materials
H	Heavy-weight materials

	DDL-9000C-FMS	DDL-9000C-FSH	DDL-9000C-FDS
Max. sewing speed (standard locus)	Stitch length 0 to 4.00 : 5,000 sti/min Stitch length 4.05 to 5.00 : 4,000 sti/min	Stitch length 0 to 4.00 : 4,500 sti/min Stitch length 4.05 to 5.00 : 4,000 sti/min	Stitch length 0 to 5.00 : 4,000 sti/min
Stitch length	5 mm		
Presser foot pressure control	Electronic control		
Needle *1	1738 Nm65 to 110 (DB×1 #9 to 18) 134 Nm65 to 110 (DP×5 #9 to 18)	1738 Nm125 to 160 (DB×1 #20 to 23) 134 Nm125 to 160 (DP×5 #20 to 23)	1738 Nm65 to 110 (DB×1 #9 to 18) 134 Nm65 to 110 (DP×5 #9 to 18)
Lubricating oil	JUKI NEW DEFRIX OIL No. 1 or JUKI CORPORATION GENUINE OIL 7		-
Motor	AC servo motor		
Horizontal feed control	Electronic control		
Vertical feed control	Electronic control		
Number of patterns	Sewing pattern99 patterns (For the polygonal shape sewing, as many as 10 patterns can be registered.) Cycle sewing pattern9 patterns Custom-pitch pattern20 patterns Condensation custom pattern9 patterns		
Noise	FMS ; - Equivalent continuous emission sound pressure level (L _{pA}) at the workstation: A-weighted value of 81.5 dBA ; (Includes K _{pA} = 2.5 dBA) ; according to ISO 10821- C.6.2 -ISO 11204 GR2 at 5,000 sti/min. FSH ; - Equivalent continuous emission sound pressure level (L _{pA}) at the workstation: A-weighted value of 77.5 dBA ; (Includes K _{pA} = 2.5 dBA) ; according to ISO 10821- C.6.2 -ISO 11204 GR2 at 4,500 sti/min. FDS ; - Equivalent continuous emission sound pressure level (L _{pA}) at the workstation: A-weighted value of 78.0 dBA ; (Includes K _{pA} = 2.5 dBA) ; according to ISO 10821- C.6.2 -ISO 11204 GR2 at 4,000 sti/min.		

• The sewing speed will vary depending on the sewing conditions. The sewing speed preset at the time of shipping is 4,000 sti/min.

*1 : Needle used depends on the destination.

1-2. Specifications of the control box

	Single phase	3-phase	Single phase	Single phase
Supply voltage	100 to 120V	200 to 240V	220 to 240V	220 to 240V CE
Frequency	50Hz/60Hz	50Hz/60Hz	50Hz/60Hz	50Hz/60Hz
Operating environment	Temperature : 0 to 35°C Humidity : 90% or less	Temperature : 0 to 35°C Humidity : 90% or less	Temperature : 0 to 35°C Humidity : 90% or less	Temperature : 0 to 35°C Humidity : 90% or less
Input	520VA	520VA	520VA	350VA

2-2. Cautions when setting up the sewing machine

Thank you very much for the purchase of JUKI Industrial Sewing Machine this time. Make sure of items 2-1 through 2-12 before operating to use this sewing machine with ease.

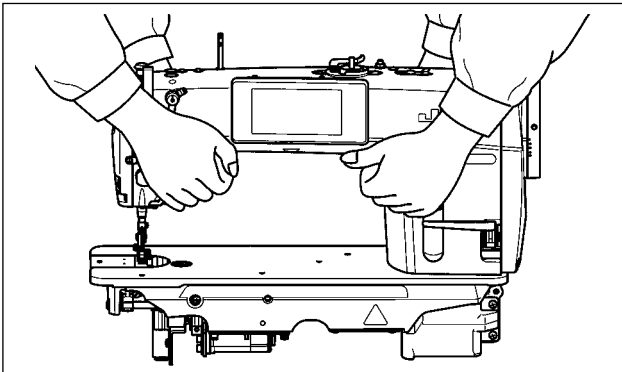

2-2-1. How to carry the sewing machine

Carry the sewing machine while holding the machine arm with two persons as shown in the figure.



1. Never hold the handwheel since it rotates.
2. Be sure to handle the sewing machine with two persons or more since the sewing machine weighs 40.5 kg or more.

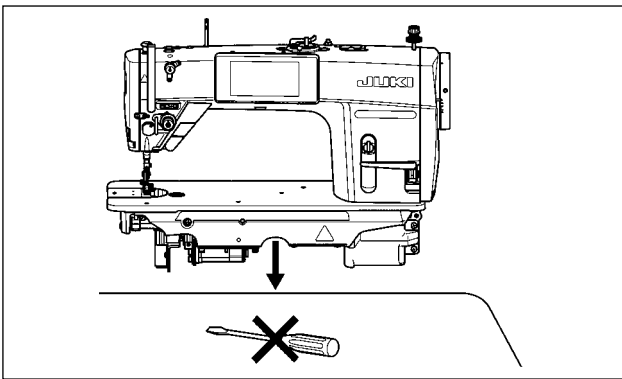

2-2-2. Caution when placing the sewing machine

Place the sewing machine on a horizontal and plane place when placing it and do not place any protruding thing such as a screwdriver or the like.

2-3. Installation

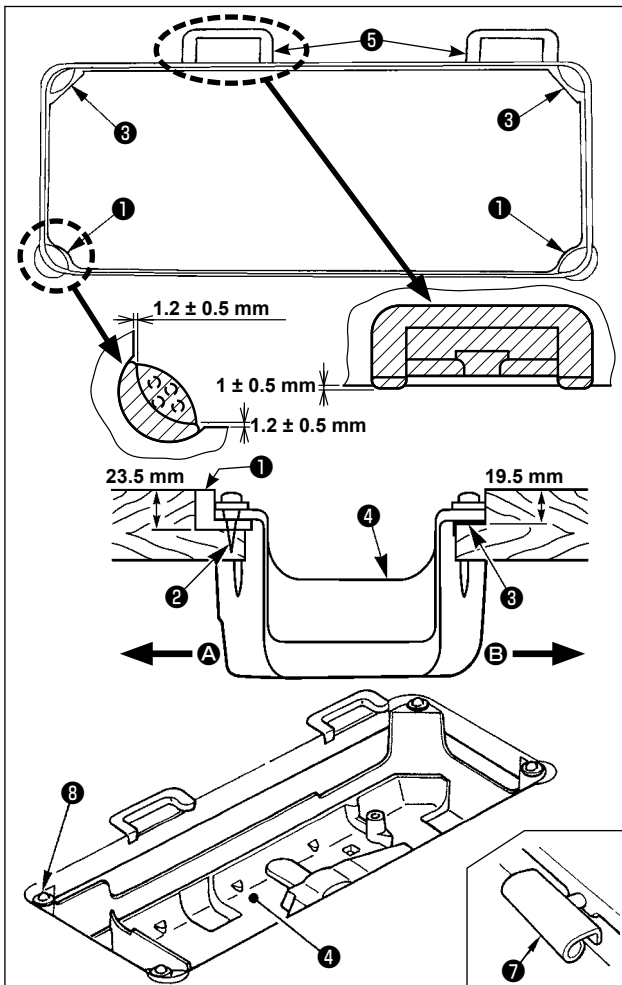

- 1) The under cover ④ should rest on the four corners of the machine table groove. Mount rubber hinge seat ⑤ on the table and fix it on the table with a nail.
- 2) Fix two rubber seats ① on side A (operator's side) using nails ② as illustrated above. Fix two cushion seats ③ on side B (hinged side) using a rubber-based adhesive. Then place under cover ④ on the fixed seats.
- 3) Fit hinge ⑦ into the opening in the machine bed, and fit the machine head to table rubber hinge seat ⑤ before placing the machine head on cushions ③ on the four corners.



Do not hold the handwheel.

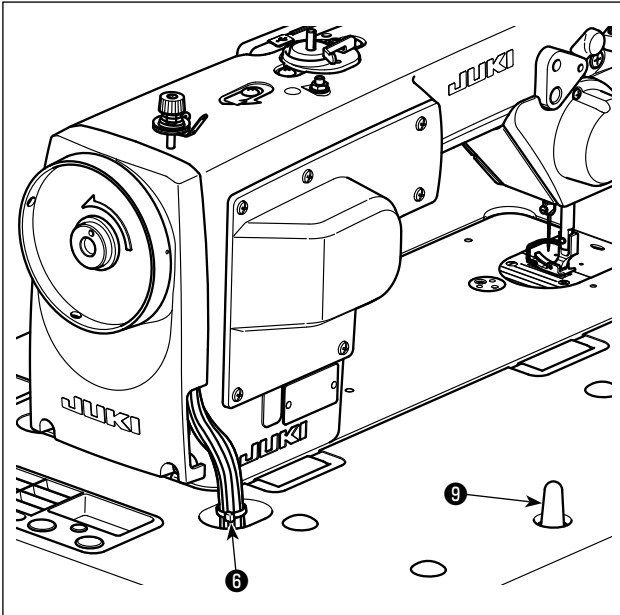

4) Securely attach head support rod ⑨ to the table until it goes no further.



Be sure to mount the machine head support rod ⑨ on the machine table so that its height from the table surface becomes 63 to 68 mm. For the sewing machine provided with the AK device, be sure to mount the support rod ⑨ on the table so that its height from the table surface becomes 33 to 38 mm.

5) Bundle cable clip band ⑥ supplied as accessories of the machine head at the root of the cable.

2-4. Installing the thread stand

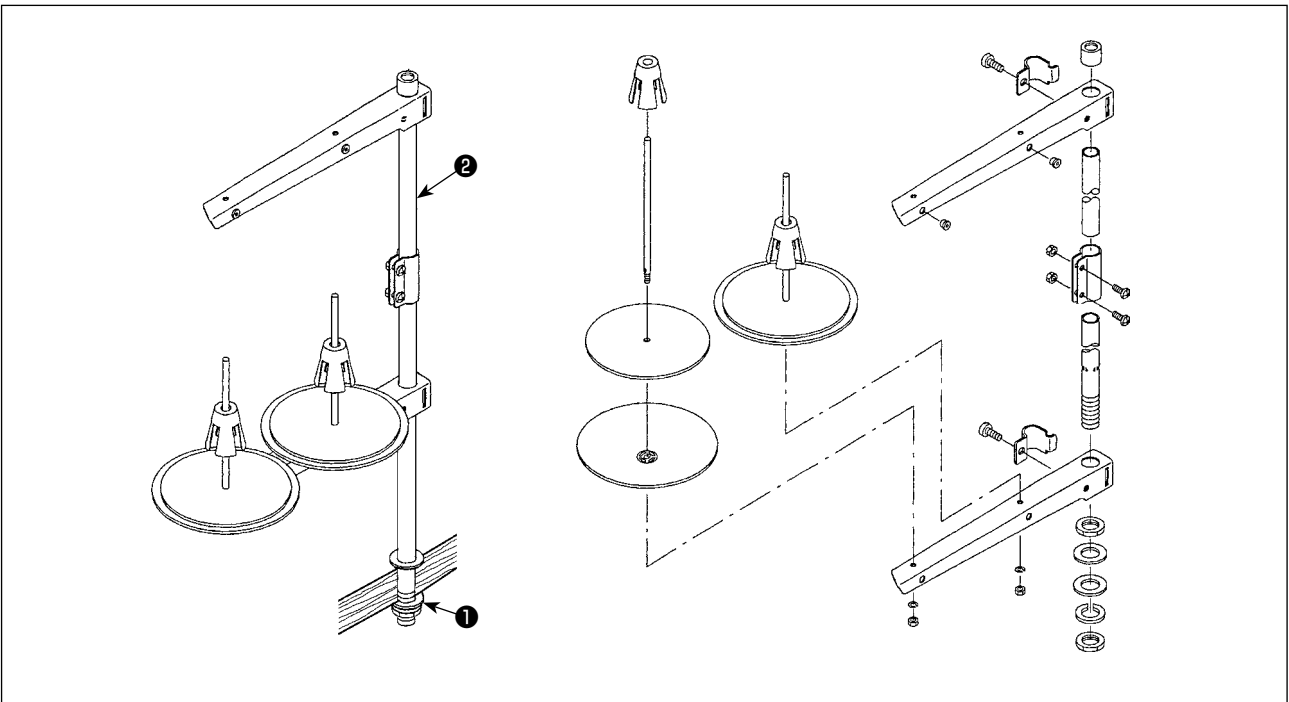

1) Assemble the thread stand unit, and insert it in the hole in the machine table.

2) Tighten nut ①.

3) For ceiling wiring, pass the power cord through spool rest rod ②.

2-5. Installing the electrical box

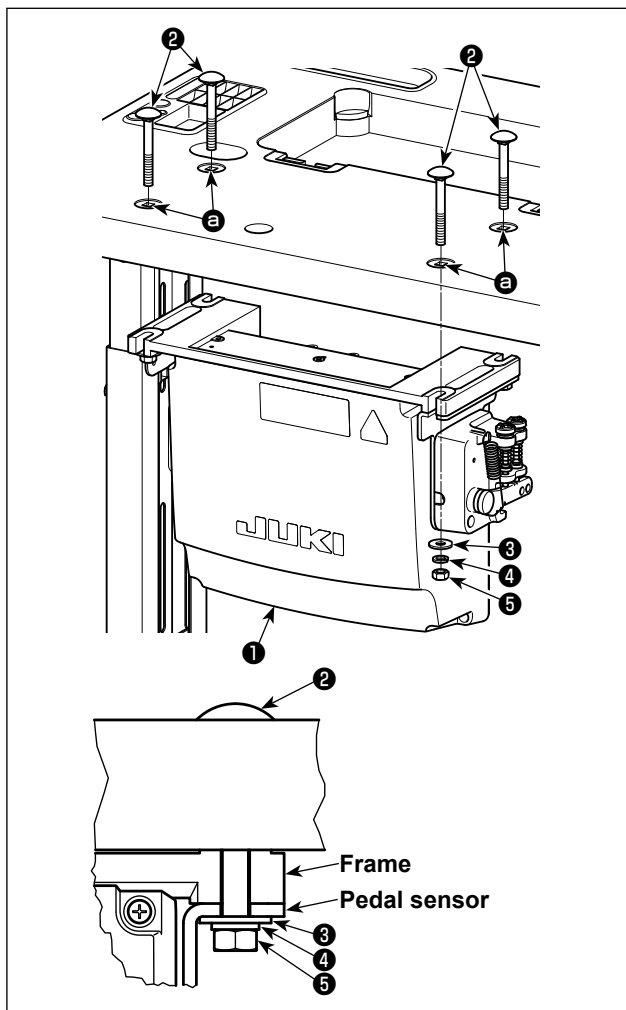

Install control box **1** on the table using four holes **a** in the table. Secure the control box with four bolts **2**, four plain washers **3**, four spring washers **4** and four hexagonal nuts **5** supplied with the control box.

At this time, insert the nut and washer supplied with the unit as accessories as shown in the figure so that the control box is securely fixed.

2-6. Connecting the power switch cable

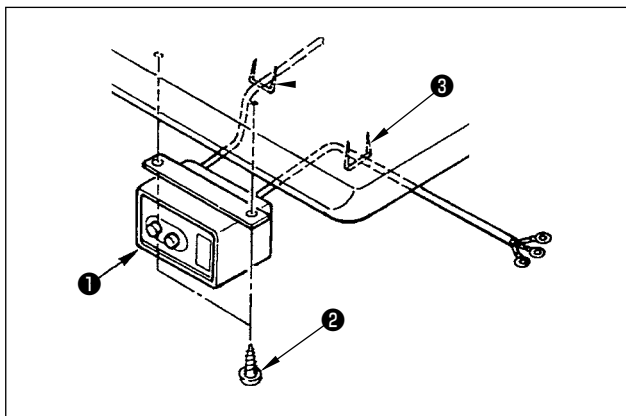

2-6-1. Installing the power switch

Fix power switch **1** under the machine table with wood screws **2**.

Fix the cable with staples **3** supplied with the machine as accessories in accordance with the forms of use.

2-6-2. Connecting the power source cord

Voltage specifications at the time of delivery from the factory are indicated on the voltage indication seal. Connect the cord in accordance with the specifications.

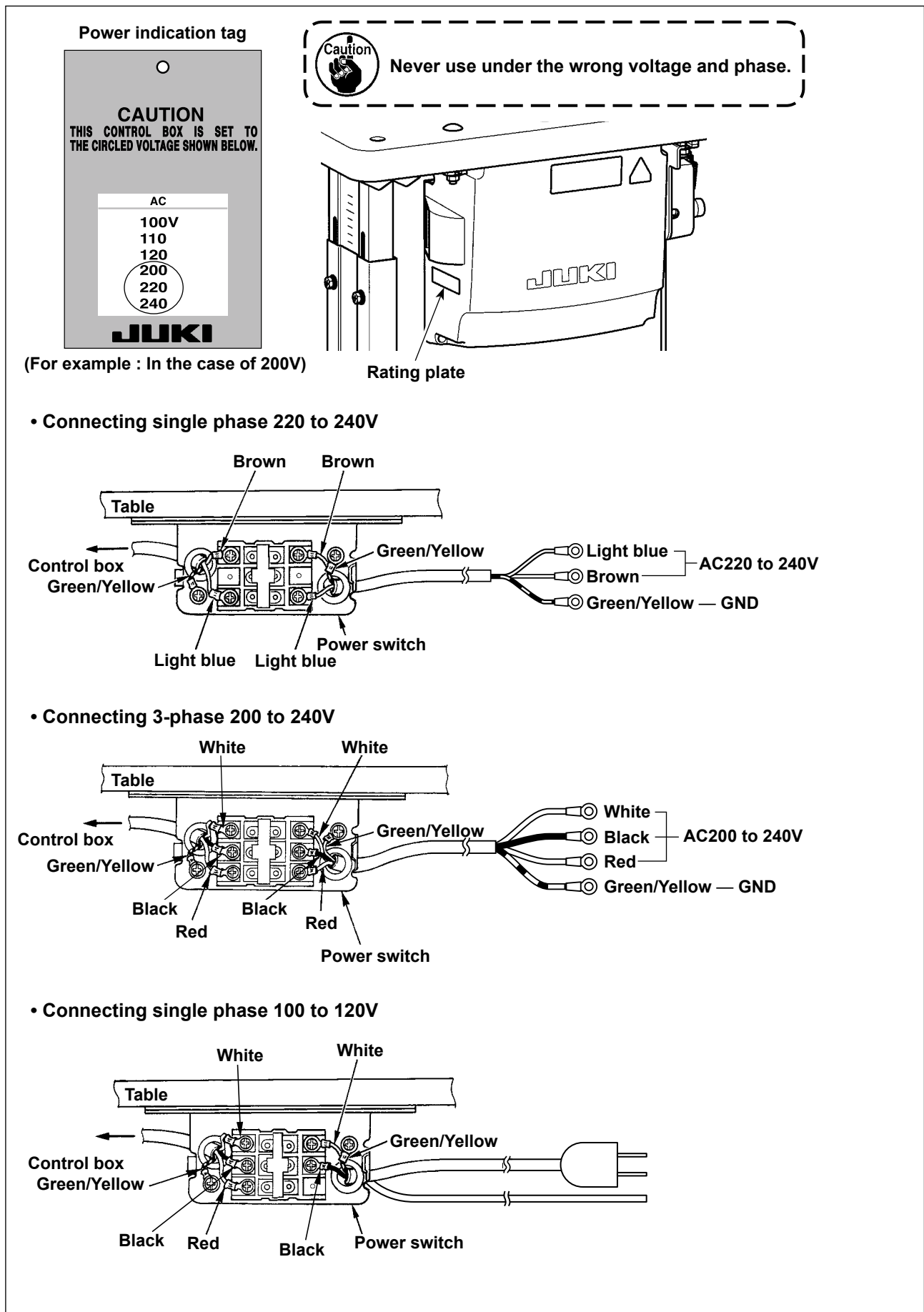

2-6-3. Installing the reactor box

* For the EU-type models, install the reactor box that is supplied with the sewing machine.

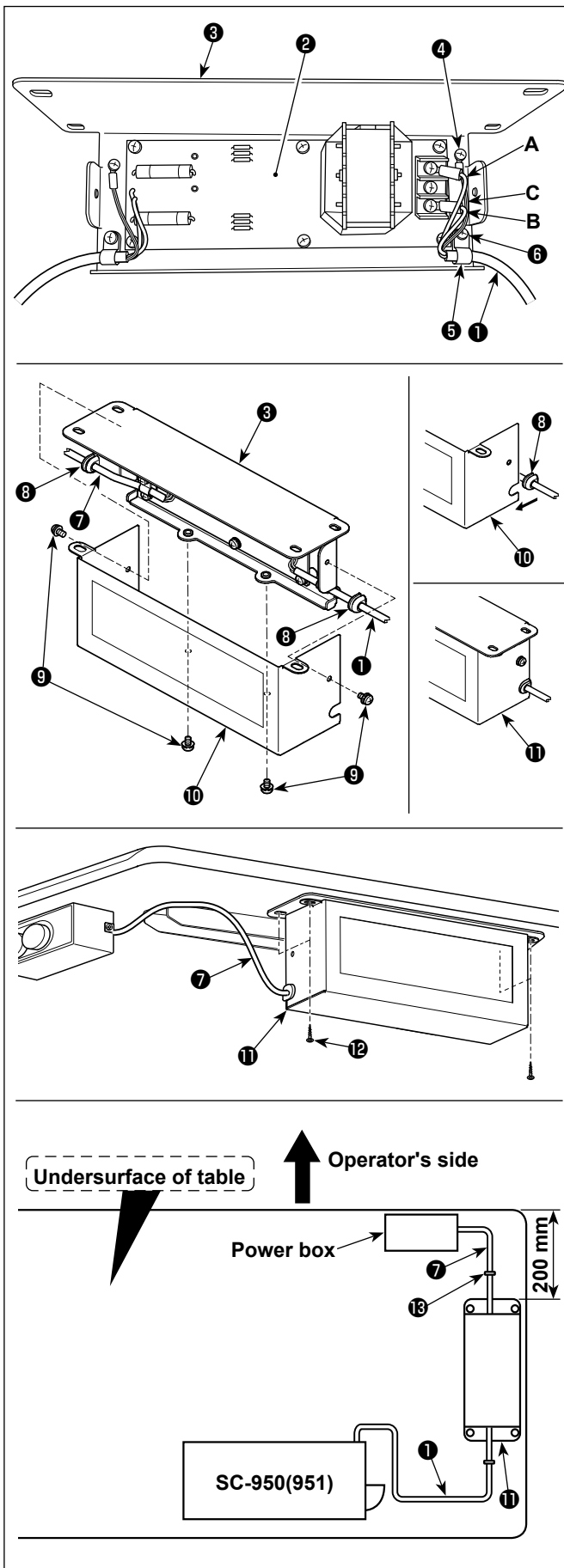

- 1) Connect the terminals of power cord ① of the SC-950(951) to reactor-box PCB asm. ② and to reactor box mounting plate ③.
Connect brown wire A to the first connector and blue wire B to the third connector respectively from the top of terminal block on the reactor box PCB asm. using screws. Connect green/yellow wire C to reactor box mounting plate ③ with earth setscrew ④.
- 2) Attach cable clip ⑤ to the power cord of SC-950(951). Attach the power cord together with the cable clip to reactor box mounting plate ③ with cable clip setscrew ⑥.
- 3) Attach cord bushes ⑧ to input/output cables ① and ⑦ of the reactor box. Attach both bushes in the same manner.
- 4) Attach reactor box cover ⑩ to reactor box mounting plate ③ with four reactor-box cover setscrews ⑨.
At this time, fix cord bushes ⑧ attached to input/output cables ① and ⑦ in the concave section on reactor box cover ⑩ to eliminate a gap between reactor box ⑪ and cover ⑩.
- 5) Install reactor box ⑪ on the table stand with four accessory wood screws ⑫ at the position that is approximately 200 mm away from the front end of table stand.
Adjust the installing position according to the size of table stand so that the reactor box does not protrude from the edge of table stand.
- 6) Fix input/output cables ① and ⑦ of reactor box ⑪ on the table stand using accessory cord staple ⑬.
At this time, take care not to cross the input- and output-cables.

2-7. Connecting the cords



DANGER :

1. To prevent personal injuries caused by electric shock hazards or abrupt start of the sewing machine, carry out the work after turning OFF the power switch and a lapse of 5 minutes or more.
2. To prevent accidents caused by unaccustomed work or electric shock, request the electric expert or engineer of our dealers when adjusting the electrical components.

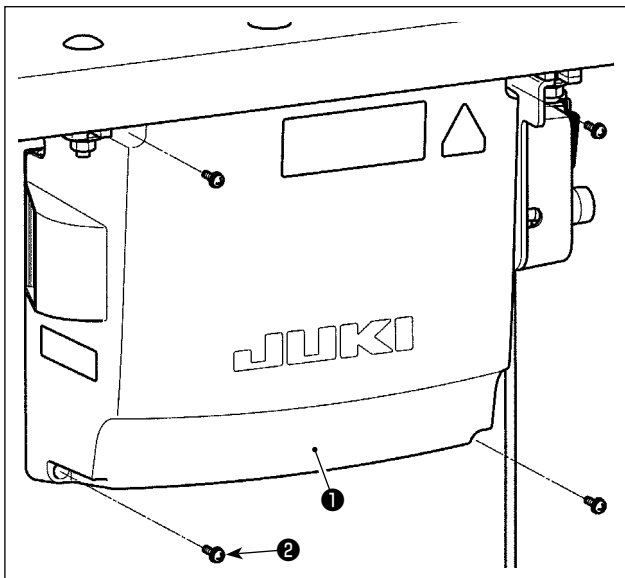

- 1) Loosen four setscrews ② of control box cover ①. Remove control box cover ①.
- 2) Connect the cords to the respective connectors on CTL PWB, PWR PWB. (Fig. 1)



Securely fix the cords to be connected to CN20, CN21 and CN22 with cable clamp ③. Check the connector markers of CN21 and CN22 to prevent improper connection.

- 3) Fix the ground wire ④ on position A of the control box with a screw. (Fig. 2)

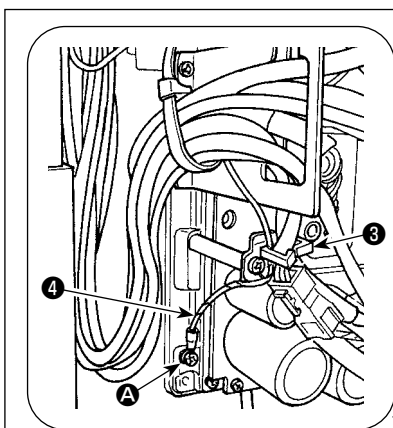
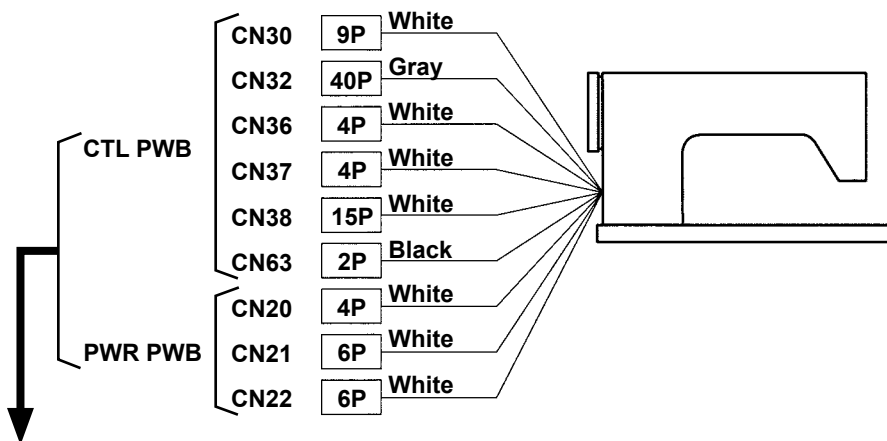

Fig. 2

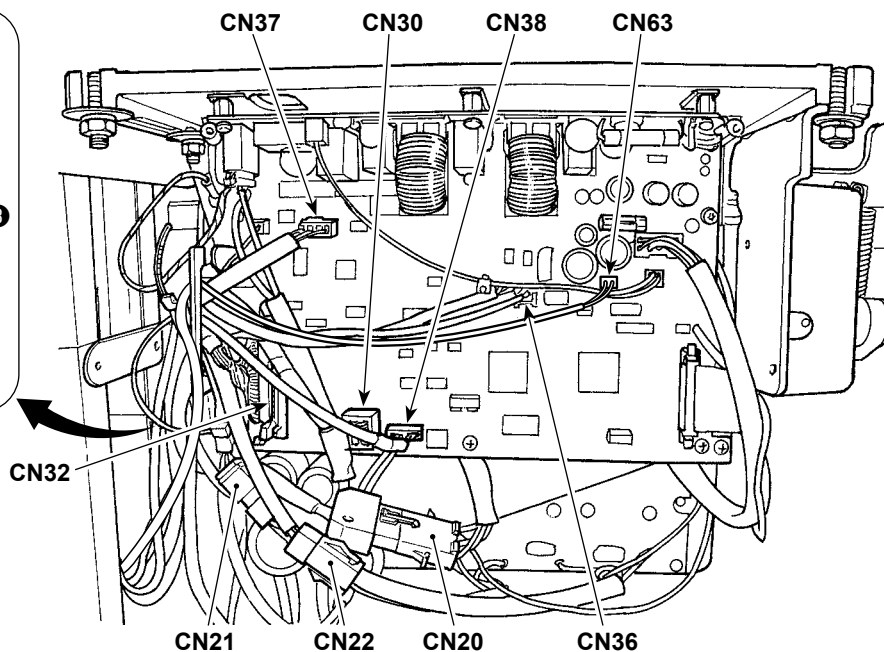



Fig. 1

2-8. Handling the cords

DANGER :



1. To prevent personal injuries caused by electric shock hazards or abrupt start of the sewing machine, carry out the work after turning OFF the power switch and a lapse of 5 minutes or more.
2. To prevent accidents caused by unaccustomed work or electric shock, request the electric expert or engineer of our dealers when adjusting the electrical components.

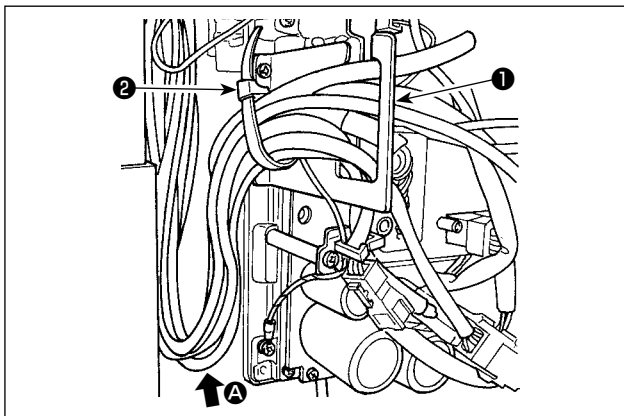

- 1) Bring the cords under the table into the control box.
- 2) Put the cord brought into the control box through cord exit plate ① and fix cable clip band ②.

Caution



Arrange the cord so that it is not tensed or hitched even when the machine head is tilted. (See A section.)

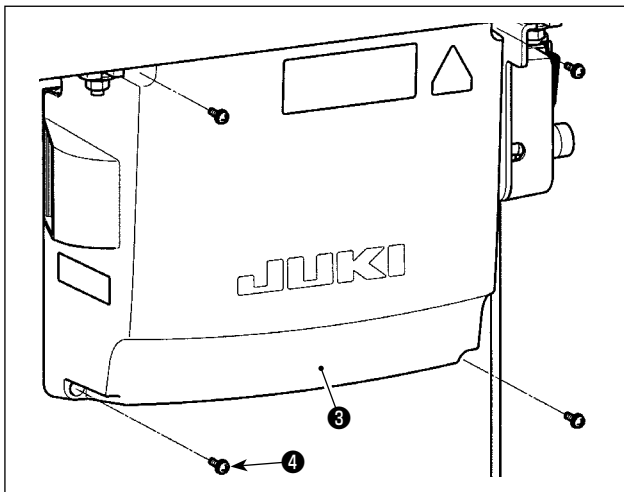

- 3) Install control box cover ③ with four setscrews ④.

Caution



For the purpose of preventing the cord breakage, take care not to allow the cords to be caught between the control box and control box cover ③ when attaching the latter.

2-9. Attaching the connecting rod

WARNING :



To protect against possible personal injury due to abrupt start of the machine, be sure to start the following work after turning the power off and a lapse of 5 minutes or more.

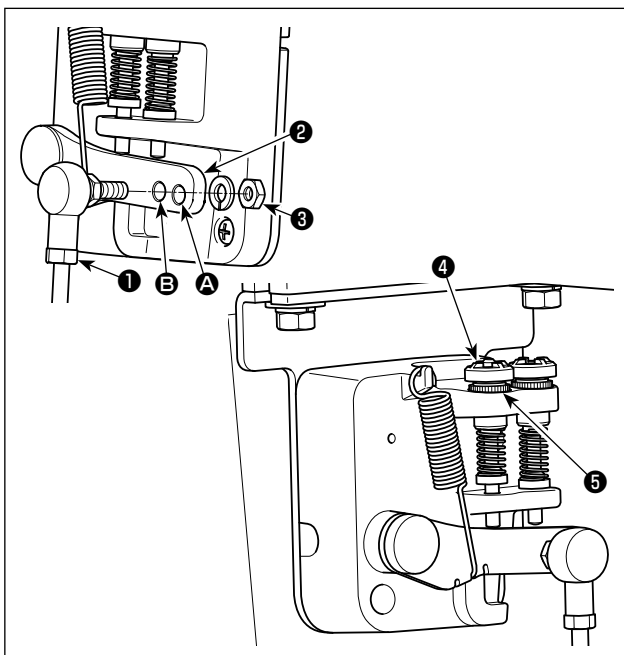

- 1) Fix connecting rod ① to installing hole B of pedal lever ② with nut ③.
- 2) Installing connecting rod ① to installing hole A will lengthen the pedal depressing stroke, and the pedal operation at a medium speed will be easier.
- 3) The pressure increases as you turn reverse depressing regulator screw ④ in, and decreases as you turn the screw out.

Caution



1. If the screw is excessively loosened, the spring will come off. Loosen the screw to such an extent that the top of the screw can be observed from the case.
2. Whenever you have adjusted the screw, be sure to secure the screw by tightening metal nut ⑤ to prevent the screw from loosening.

2-10. Adjustment of the pedal



WARNING :

Turn OFF the power before starting the work so as to prevent accidents caused by abrupt start of the sewing machine.

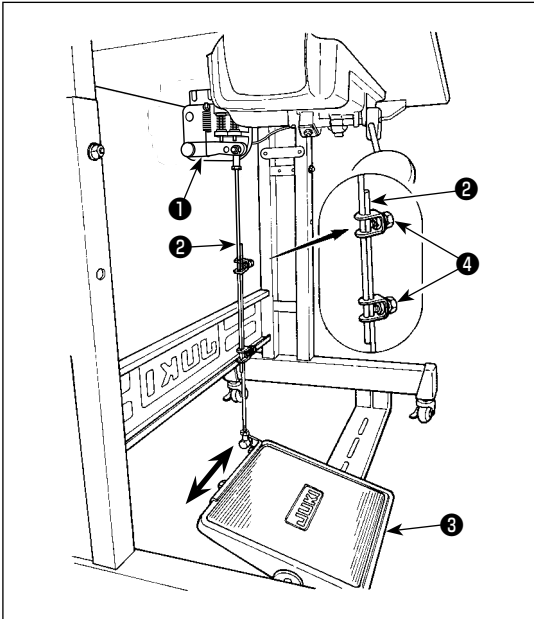

2-10-1. Installing the connecting rod

- 1) Move pedal ③ to the right or left as illustrated by the arrows so that motor control lever ① and connecting rod ② are straightened.

2-10-2. Adjusting the pedal angle

- 1) The pedal tilt can be freely adjusted by changing the length of the connecting rod ②.
- 2) Loosen adjust screw ④, and adjust the length of connecting rod ②.

2-11. Pedal operation

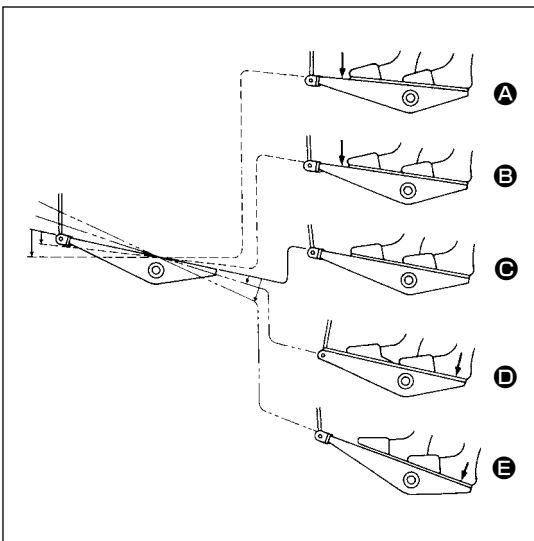

The pedal is operated in the following four steps :

- 1) The machine runs at low sewing speed when you lightly depress the front part of the pedal. ②
- 2) The machine runs at high sewing speed when you further depress the front part of the pedal. ① (If the automatic reverse feed stitching has been preset, the machine runs at high speed after it completes reverse feed stitching.)
- 3) The machine stops (with its needle up or down) when you reset the pedal to its original position. ③
- 4) The machine trims threads when you fully depress the back part of the pedal. ⑤

* When the auto-lifter (AK device) is used, one more operating switch is provided between the sewing machine stop switch and thread trimming switch.

The presser foot goes up when you lightly depress the back part of the pedal ④, and if you further depress the back part, the thread trimmer is actuated.

When starting sewing from the state that the presser foot has been lifted with the Auto-lifter and you depress the back part of the pedal, the presser foot only comes down.

- If you reset the pedal to its neutral position during the automatic reverse feed stitching at seam start, the machine stops after it completes the reverse feed stitching.
- The machine will perform normal thread trimming even if you depress the back part of the pedal immediately following high or low speed sewing.
- The machine will completely perform thread trimming even if you reset the pedal to its neutral position immediately after the machine started thread trimming action.

2-12. Lubrication (DDL-9000C-FMS, FSH)

WARNING :



1. Do not connect the power plug until the lubrication has been completed so as to prevent accidents due to abrupt start of the sewing machine,
2. To prevent the occurrence of an inflammation or rash, immediately wash the related portions if oil adheres to your eyes or other parts of your body.
3. If oil is mistakenly swallowed, diarrhea or vomiting may occur. Put oil in a place where children cannot reach.

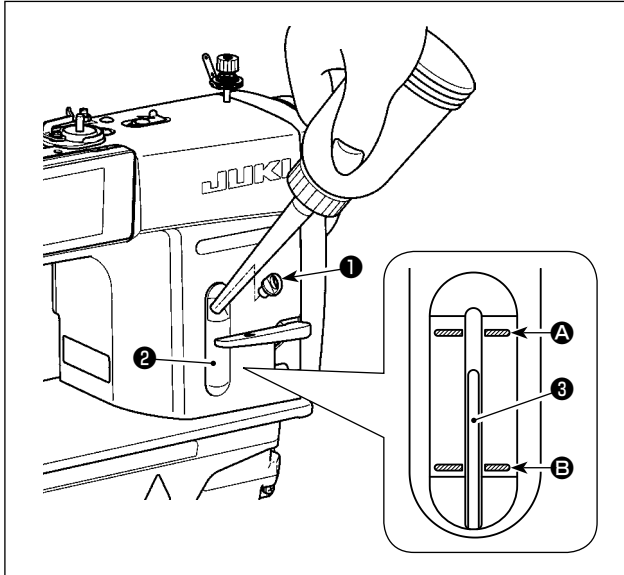

Fill the oil tank with oil for hook lubrication before operating the sewing machine.

- 1) Remove oil hole cap ❶ and fill the oil tank with JUKI NEW DEFRIX OIL No.1 (part number : MD-FRX1600C0) or JUKI CORPORATION GENUINE OIL 7 (part number : 40102087) using the oiler supplied with the machine.

- 2) Fill the oil tank with the oil until the top end of oil amount indicating rod ❸ comes between the upper engraved marker line ❸ and the lower engraved marker line ❸ of oil amount indicating window ❷.

If the oil is filled excessively, it will leak from the air vent hole in the oil tank or proper lubrication will be not performed. In addition, when the oil is vigorously filled, it may overflow from the oil hole. So, be careful.

- 3) When you operate the sewing machine, refill oil if the top end of oil amount indicating rod ❸ comes down to the lower engraved marker line ❸ of oil amount indicating window ❷.



1. When you use a new sewing machine or a sewing machine after an extended period of disuse, use the sewing machine after performing break-in at 2,000 sti/min or less.
2. For the oil for hook lubrication, purchase JUKI NEW DEFRIX OIL No. 1 (part number : MDFRX1600C0) or JUKI CORPORATION GENUINE OIL 7 (part number : 40102087).
3. Be sure to lubricate clean oil.
4. Do not operate the machine with the oil hole cap ❶ removed. Never remove cap ❶ from the oil inlet in any case other than oiling. In addition, take care not to lose it.

2-13. How to use the operation panel (Basic explanation)

2-13-1. Selection of the language (operation to be done at first)

Select the language to be displayed on the operation panel when you turn ON the power to your sewing machine for the first time after the purchase. Note that, if you turn the power OFF without selecting the language, the language selection screen will be displayed every time you turn ON the power to the sewing machine.

① Turning ON the power switch



Be aware that the needle bar moves automatically. The needle bar can also be set so that it does not move automatically. Refer to "4-5. List of memory switch data" p. 64 for details.



<Welcome screen>

Firstly, the welcome screen is displayed on the panel. Then, the language selection screen is displayed.

② Selecting the language



<Language selection screen>

Select the language you want to use and press corresponding language button ①.

Then, press  ②.

This determines the language to be displayed on the panel.

The language to be displayed on the operation panel can be changed using the memory switch U406. Refer to "4-5. List of memory switch data" p. 64 for details.

③ Setting the clock

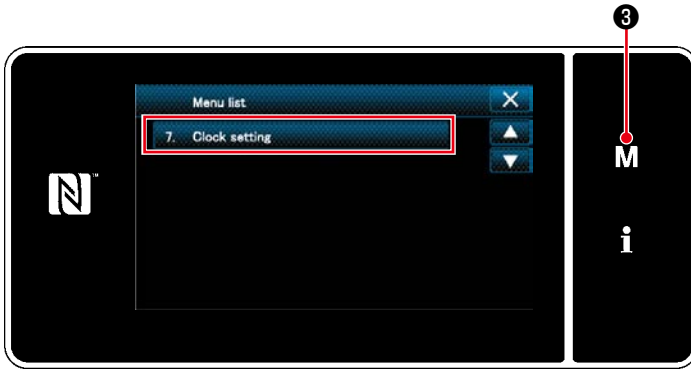

<Mode screen>

1. Press **M** ③ .

The "mode screen" is displayed.

2. Select the "7. Clock setting".

The "clock setting screen" is displayed.

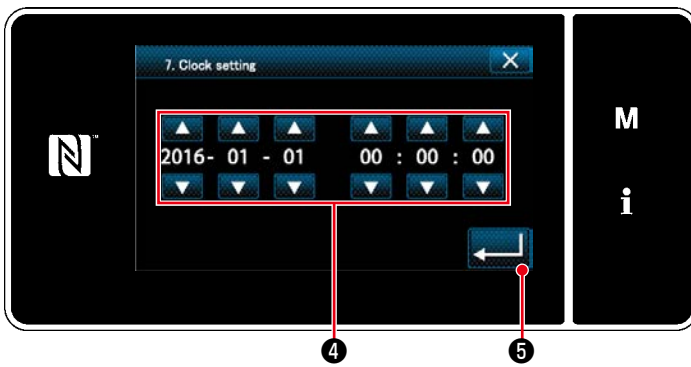

<Clock setting screen>

3. Enter year/month/day/hour/minute/second with



④ .

The time entered is displayed in 24-hour notation.

4. Press  ⑤ to confirm the clock setting. Then, the current screen returns to the previous screen.

④ Retrieval of the origin

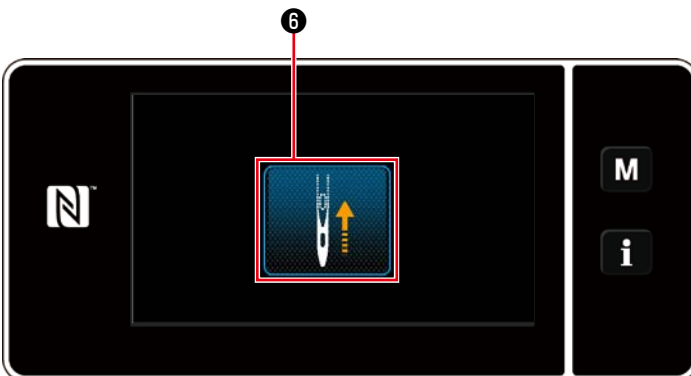

<Origin retrieval screen>

Press **M** ⑥ to bring the origin retrieval needle bar to its upper position.

* In the case "U090 Initial operation upper position stop function" is set to "1", the screen shown on the left is not displayed, but the needle bar automatically goes up to its upper position.

2-13-2. Names and functions of the panel keys

* Changeover between the operator mode and the maintenance personnel mode is carried out by pressing **M** ① and **i** ② simultaneously.

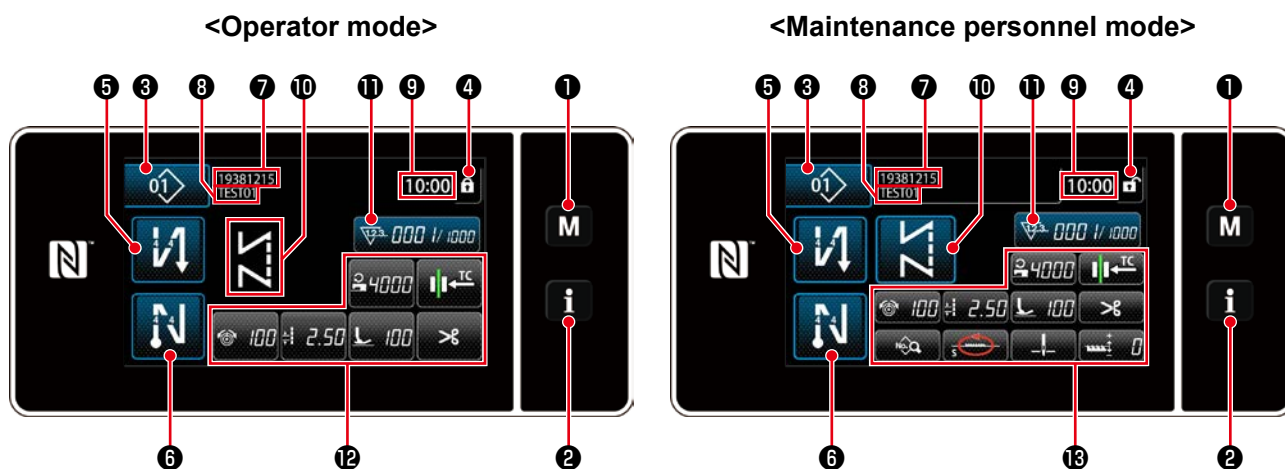

	Switch/display	Description
①	Mode key	This switch is used for displaying the menu screen.
②	Information key	This switch is used for displaying the information screen.
③	Sewing pattern No. button	This switch is used for displaying the number of the sewing pattern.
④	Simplified screen lock button	This button is used for displaying the simplified lock status of the screen on it. Locked: Unlocked:
⑤	Sewing-start reverse-feed stitch button	This switch is used for changing the ON/OFF status of the reverse feed stitching at the beginning of sewing. When reverse feed stitching at the beginning of sewing is placed in the OFF state, mark is displayed at the upper left of the button.
⑥	Sewing-end reverse-feed stitch button	This switch is used for changing the ON/OFF status of reverse feed stitching at the end of sewing. When reverse feed stitching at the end of sewing is placed in the OFF state, mark is displayed at the upper left of the button.
⑦	Part number	In the case the part number/process display is selected with U404, the part number is displayed. In the case the comment display is selected, the comment is displayed.
⑧	Process/comment	In the case the part number/process display is selected with U404, the process is displayed. In the case the comment display is selected, the comment is displayed.
⑨	Clock display	The time set on the sewing machine is displayed in this field in 24-hour system.
⑩	Sewing pattern display	The selected sewing pattern is displayed in this field.
⑪	Customization button 1	A selected function can be allocated to and registered with this button. Initially, the sewing counter has been factory-allocate and -registered.
⑫	Customization buttons 2 - 7	A selected function can be allocated to and registered with this button.
⑬	Customization buttons 2 - 11	A selected function can be allocated to and registered with this button.

* Confirmation of data

To change the pattern number, press Sewing pattern No. button ③ .

Select the sewing pattern you want to use. Then, press to confirm your choice.

For the setting items of the Memory switch or sewing pattern, change the target data and press to confirm the change.

After the setting data on the number of stitches of reverse-feed stitching or the number of stitches of multi-layer stitching has been changed, the changed setting data is confirmed by pressing .

2-13-3. Basic operation

① Turning ON the power switch



When you turn ON the power switch, the welcome screen is displayed.

② Selecting a sewing pattern



<Sewing screen (Operator mode)>



<Sewing screen (Maintenance personnel mode)>

The sewing screen is displayed.

- Select a sewing pattern.
Refer to **"4-2. Sewing patterns" p. 35** for details.
- Configure settings of each function which is assigned according to **"8-10. Key customization" p. 135**.
- Set up functions for the selected sewing pattern.
Refer to **"4-2-5. Editing the sewing patterns" p. 44** and **"4-2-6. List of pattern functions" p. 46** for details.

③ Starting sewing

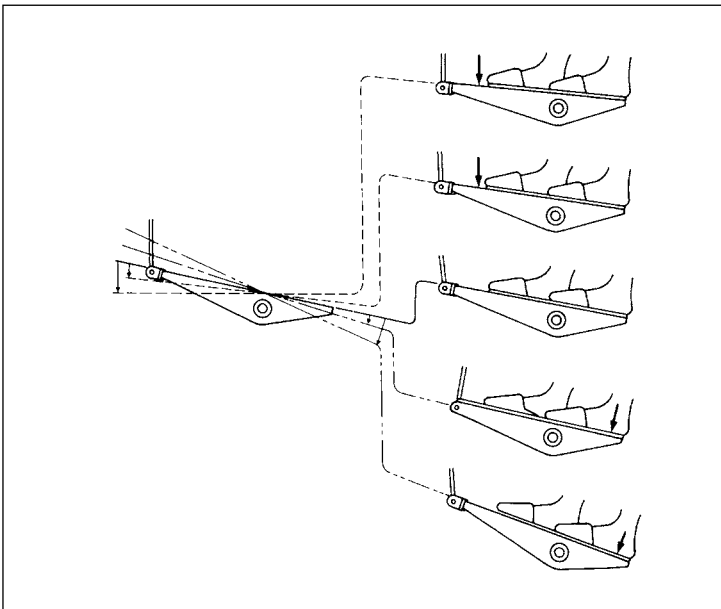

When you depress the pedal, the sewing machine starts sewing.

Refer to **"2-11. Pedal operation" p. 10**.

3. PREPARATION BEFORE SEWING

3-1. Attaching the needle



WARNING :

Turn OFF the power before starting the work so as to prevent accidents caused by abrupt start of the sewing machine.

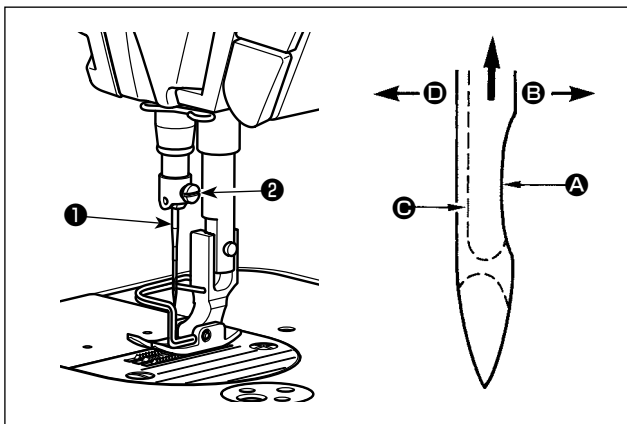

Use the specified needle for the machine. Use the proper needle in accordance with the thickness of thread used and the kinds of the materials.

- 1) Turn the handwheel until the needle bar reaches the highest point of its stroke.
- 2) Loosen screw ②, and hold needle ① with its indented part ① facing exactly to the right in direction ③.
- 3) Insert the needle fully into the hole in the needle bar in the direction of the arrow until the end of hole is reached.

4) Securely tighten screw ②.

5) Check that long groove ④ of the needle is facing exactly to the left in direction ④.



When polyester filament thread is used, if the indented part of the needle is tilted toward operator's side, the loop of thread becomes unstable. As a result, hangnail of thread or thread breakage may occur. For the thread that such phenomenon is likely to occur, it is effective to attach the needle with its indented part slightly slanting on the rear side.

3-2. Removing/fitting the bobbin case



WARNING :

Turn OFF the power before starting the work so as to prevent accidents caused by abrupt start of the sewing machine.

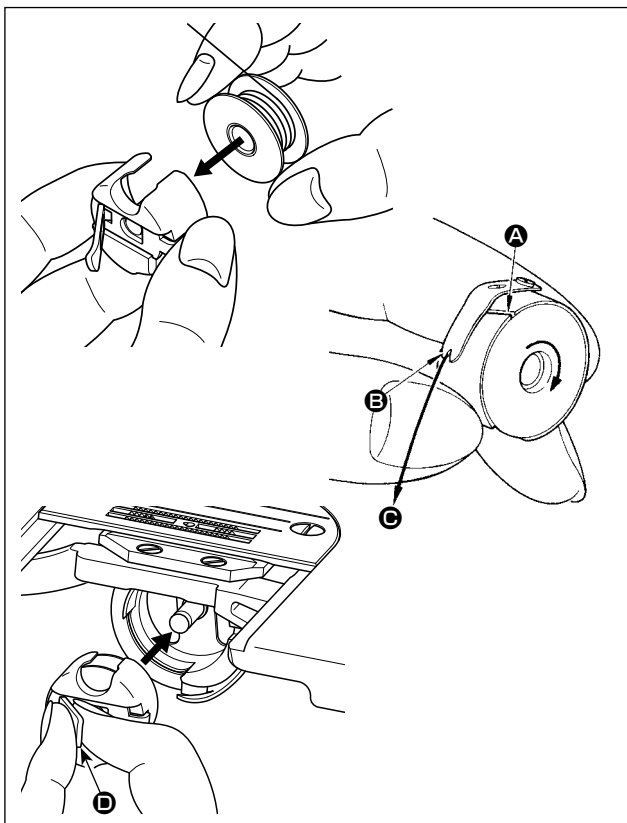

- 1) Turn the handwheel to lift the needle above the throat plate.
- 2) Install the bobbin in the bobbin case so that the thread wound direction is clockwise.
- 3) Pass the thread through thread slit ① of the bobbin case, and pull the thread in direction ③. By so doing, the thread will pass under the tension spring and come out from notch ②.
- 4) Check that the bobbin rotates in the direction of the arrow when thread is pulled.
- 5) Pinching latch ④ of the bobbin case with fingers, fit the bobbin case in the hook.

3-3. Winding the bobbin thread

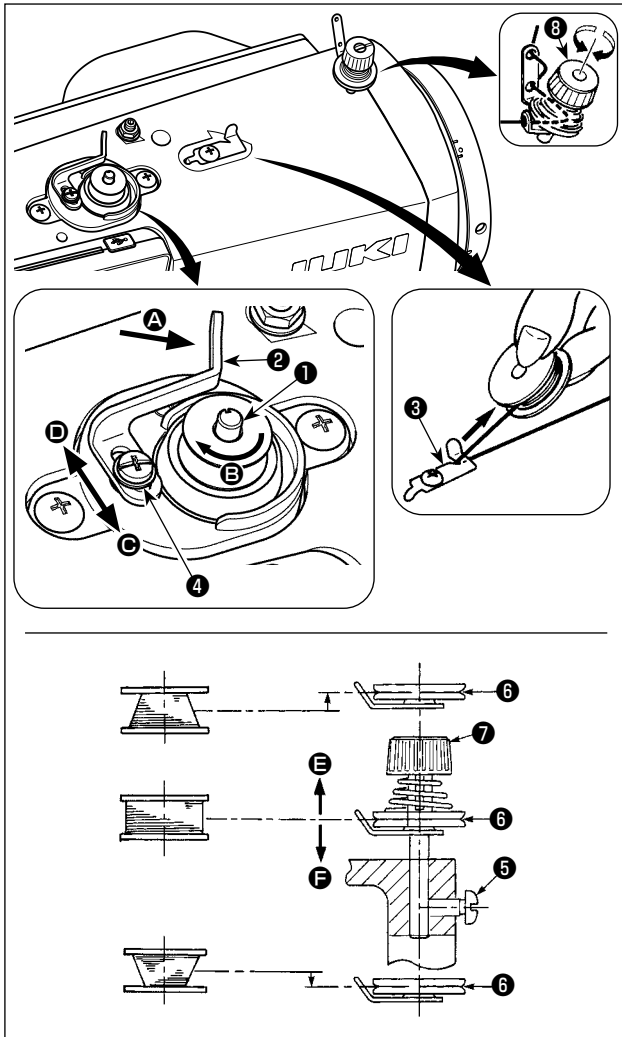

- 1) Insert the bobbin deep into the bobbin winder spindle ① until it will go no further.
- 2) Pass the bobbin thread pulled out from the spool rested on the right side of the thread stand following the order as shown in the figure on the left. Then, wind clockwise the end of the bobbin thread on the bobbin several times. (In case of the aluminum bobbin, after winding clockwise the end of the bobbin thread, wind counterclockwise the thread coming from the bobbin thread tension several times to wind the bobbin thread with ease.)
- 3) Press the bobbin winding lever ② in the direction of ① and start the sewing machine. The bobbin rotates in the direction of ② and the bobbin thread is wound up. The bobbin winder spindle ① automatically as soon as the winding is finished.
- 4) Remove the bobbin and cut the bobbin thread with the thread cut retainer ③.
- 5) When adjusting the winding amount of the bobbin thread, loosen setscrew ④ and move bobbin winding lever ② to the direction of ③ or ④. Then tighten setscrew ④.
 - To the direction of ③ : Decrease
 - To the direction of ④ : Increase

- 6) In case that the bobbin thread is not wound evenly on the bobbin, remove the handwheel, loosen screw ⑤ and adjust the height of bobbin thread tension ⑥.
 - It is the standard that the center of the bobbin is as high as the center of thread tension disk ⑥.
 - Adjust the position of thread tension disk ⑥ to the direction of ⑤ when the winding amount of the bobbin thread on the lower part of the bobbin is excessive and to the direction ⑥ when the winding amount of the bobbin thread on the upper part of the bobbin is excessive.
 After the adjustment, tighten screw ⑤.
- 7) To adjust the tension of the bobbin winder, turn the thread tension nut ⑦.



1. When winding the bobbin thread, start the winding in the state that the thread between the bobbin and thread tension disk ⑥ is tense.
2. When winding the bobbin thread in the state that sewing is not performed, remove the needle thread from the thread path of thread take-up and remove the bobbin from the hook.
3. There is the possibility that the thread pulled out from the thread stand is loosened due to the influence (direction) of the wind and may be entangled in the handwheel. Be careful of the direction of the wind.

[Bobbin winding mode]

To wind a bobbin only or to check the oil quantity in the hook, the bobbin winding mode should be used. Depress the pedal to start winding a bobbin.



1) Display the mode screen by pressing **M** ①.



2) Select the "2. Bobbin winding mode".

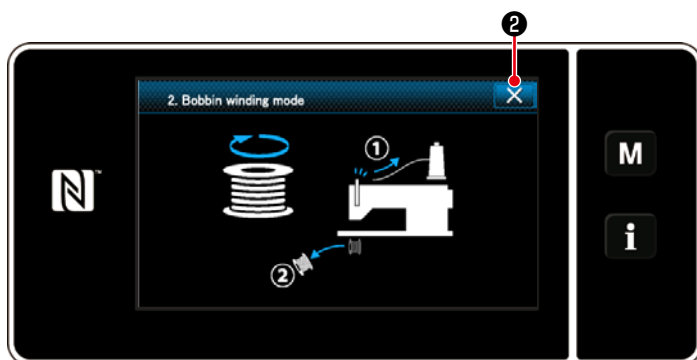

3) The sewing machine mode is changed over to the "Bobbin winding mode".
 The sewing machine runs with its presser foot up when the pedal is depressed. In this state, a bobbin can be wound. The sewing machine runs only as long as the pedal is depressed.
 When **X** ② is pressed, the sewing machine exits from the "Bobbin winding mode".

- Caution**

 1. When winding the bobbin thread, start the winding in the state that the thread between the bobbin and thread tension disk ⑥ is tense.
 2. Remove the needle thread from the thread path of thread take-up and remove the bobbin from the hook.
 3. There is the possibility that the thread pulled out from the thread stand is loosened due to the influence (direction) of the wind and may be entangled in the handwheel. Be careful of the direction of the wind.
 4. The speed of the sewing machine under the bobbin winding mode is equal to the one which has been set for the machine head.

3-4. Threading the machine head



WARNING :

Turn OFF the power before starting the work so as to prevent accidents caused by abrupt start of the sewing machine.

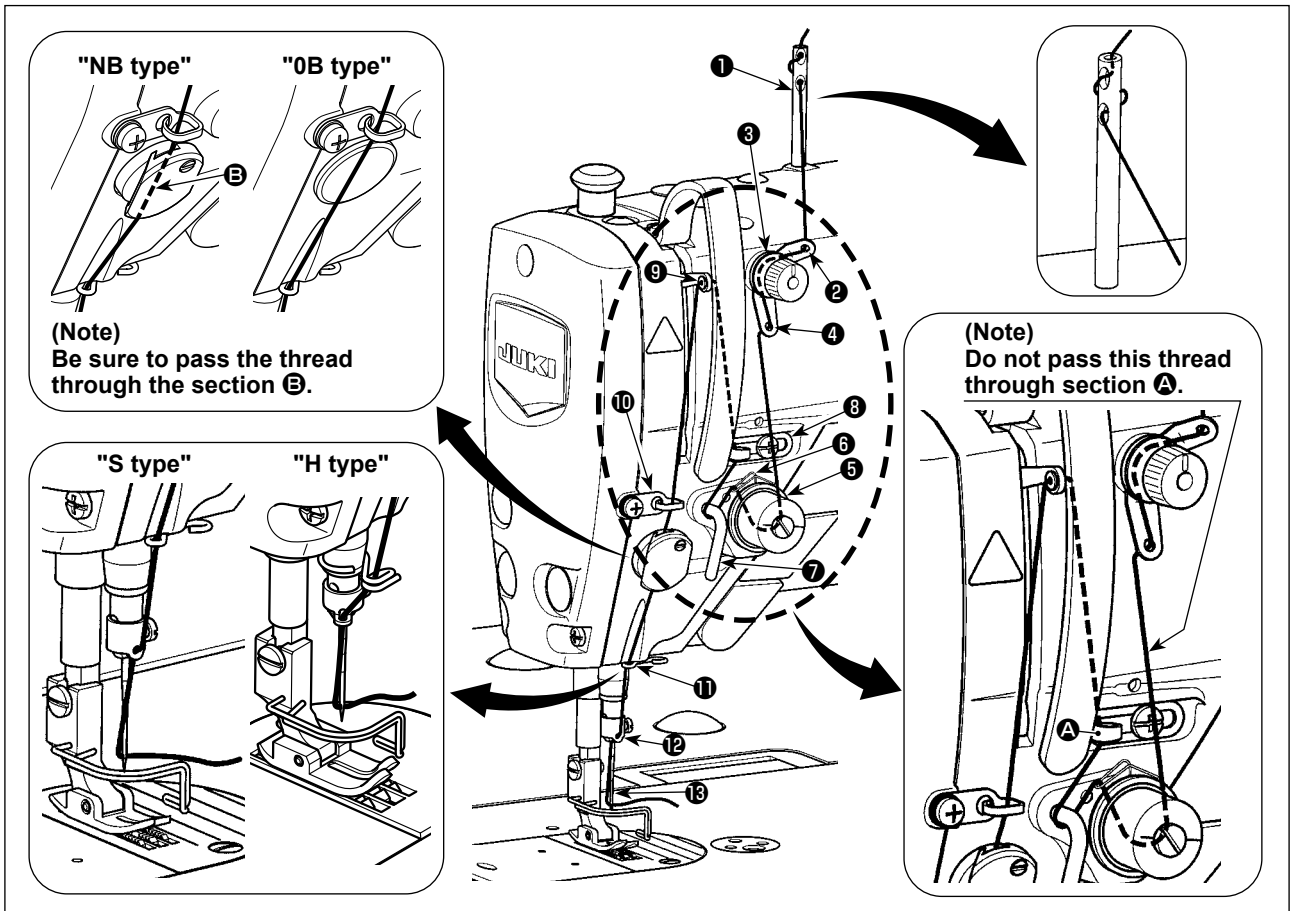

3-5. Thread tension

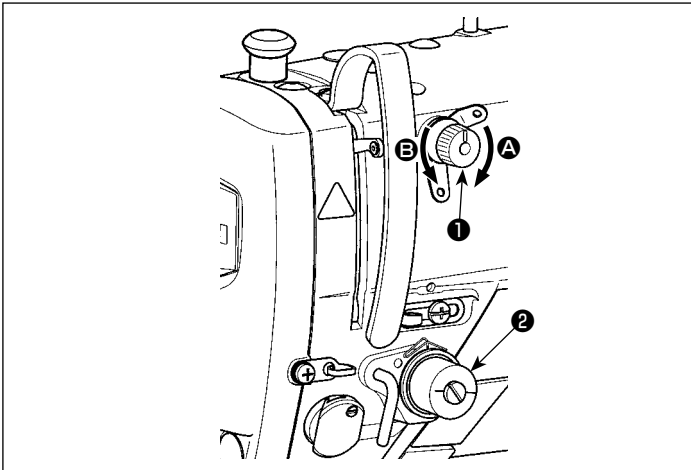

3-5-1. Adjusting the thread tension No. 1 tension

- 1) Turn thread tension No. 1 nut ① clockwise (in direction ④), to shorten the thread length remaining on the needle after thread trimming or counterclockwise (in direction ③), to lengthen the thread length.

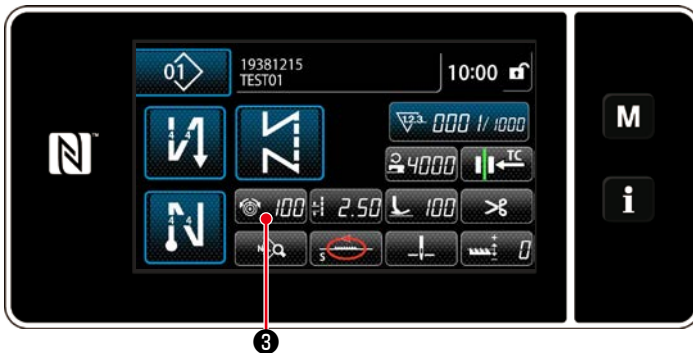

3-5-2. Adjusting the needle thread tension (Active tension)

Active tension ② permits setting of the needle thread tension on the operation panel according to each sewing condition. In addition, the data can be stored in memory.

- 1) Press  ③ to display the needle thread tension input screen. (The numeric value displayed on the screen is the current needle thread tension value.)

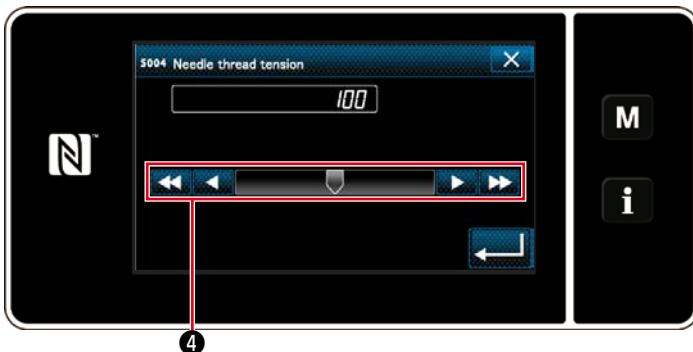

- 2) Change the needle thread tension as desired by pressing ④.

- 3) There is a setting range of 0 to 200.

When the set value is increased, the tension becomes higher.

* When the set value is 60 at the time of standard delivery, the thread tension is adjusted to 0.59 N (spun thread #60). (Reference) (When thread tension No. 1 is released.)

3-5-3. Tension correction (with respect to the bobbin thread remaining amount)

The needle thread tension can be corrected according to the remaining amount of bobbin thread. The remaining amount of bobbin thread is calculated using the set value and the current value of the counter. The needle thread tension can also be set on the operation panel. The needle thread tension data is stored in memory.

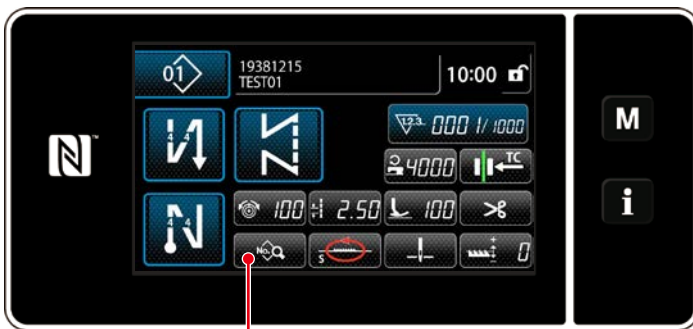

<Sewing screen (Maintenance personnel mode)>

1) Press  ① on the sewing screen under the maintenance personnel mode.

The "sewing data edit screen" is displayed.



<Sewing data edit screen>

2) Press  ②.

The "S067 Needle thread tension correction screen" is displayed.

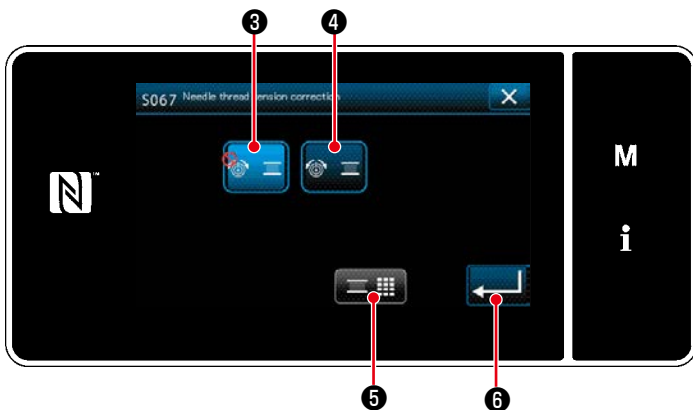



<S067 Needle thread tension correction screen>

3) Select the needle thread correction method from two options

 ③ Not use (initial setting)

and

 ④ "Enable" (bobbin thread remaining amount).

4) When you want to change the tension correction data (with respect to the bobbin thread remaining amount), press  ⑤.

* When you press  ⑥, the data you have input is confirmed and the screen returns to the sewing screen.

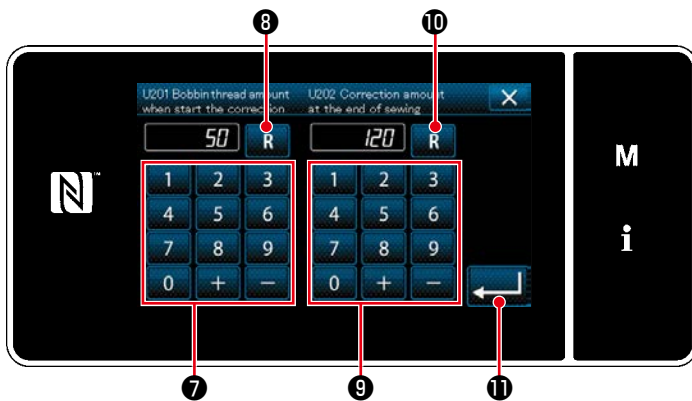

Tension correction amount [%]

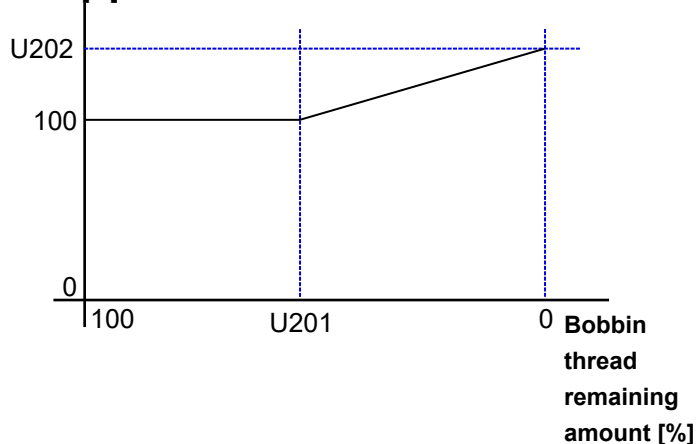

- * The thread tension correction (bobbin thread remaining amount) only operates in the case the setting of type of bobbin thread counter is placed in "Down counter".
- * Whenever you have changed the bobbin with a new one, re-set the current value of the bobbin thread counter.

5) Set "U201 Bobbin thread remaining amount for starting correction" with numeric keypad **7**.

The remaining amount of bobbin thread (in %) to start correction of the needle thread tension is set with this set value.

Refer to "**4-3. Counter function**" p.58 for how to set the bobbin counter.

The set value can be reset to the initial value of 50 by pressing **R** **8**.

6) Set "U202 Final correction amount" with the numeric keypad **9**.

Using the aforementioned set value, determine the correction ratio of the needle thread tension.

The set value can be reset to the initial value of 120 by pressing **R** **10**.

7) When **←** **11** is pressed, the entered value is confirmed and the screen is returned to the "S067 Needle thread tension correction screen".

* Refer to the figure on the left for the relation between "U201 Bobbin thread remaining amount for starting correction" and "U202 Final correction amount".

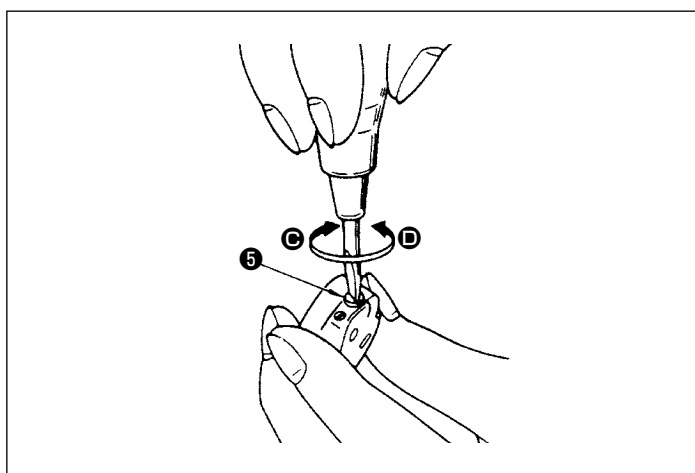

3-5-4. Adjusting the bobbin thread tension

1) Turn tension adjusting screw **5** clockwise (in direction **C**) to increase or counterclockwise (in direction **D**) to reduce the bobbin thread tension.

3-6. Presser foot (Active presser device)



WARNING :

Do not place anything under the presser foot when turning the power ON. If the power is turned ON while placing something under the presser foot, the sewing machine displays E910.



If the power to the sewing machine is turned ON while the material, etc. is placed under the presser foot, the presser stepping motor will generate a specific sound during origin retrieval. It should be noted that this phenomenon is not a fault.

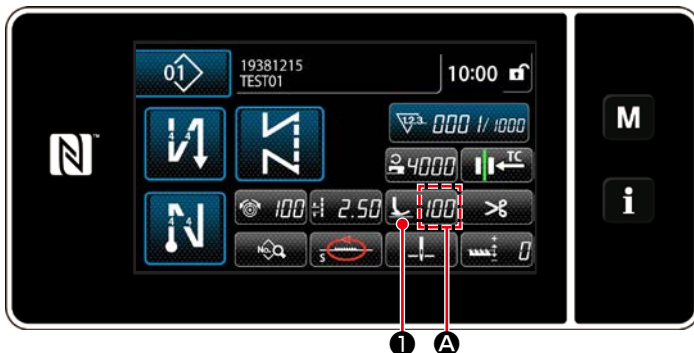

3-6-1. Presser foot pressure

The presser foot pressure is displayed in section **A** on the panel. (Example of display : 100)

[How to change]

1) Display the presser foot pressure entry screen by pressing **1**.

2) Change the presser foot pressure as desired by pressing **2**. (Range of input values on the panel is from -350 to 200.)

* Refer to the following for a rough indication of the input value on the panel and the presser foot pressure.

3) Confirm your entry by pressing **3**. Then, the sewing screen is displayed.

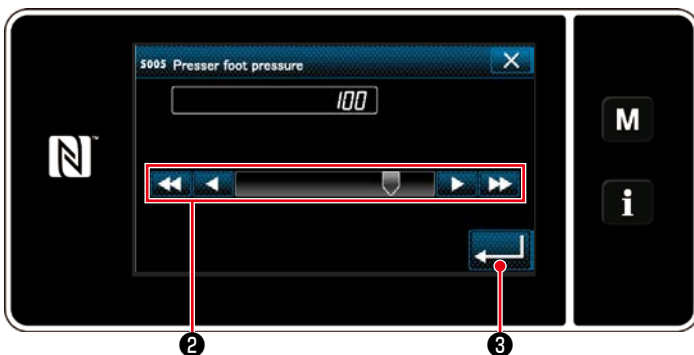

Input value on the panel	Presser foot pressure (Reference)	
	S type	H type
0	Approx. 10 N (1 kg)	Approx. 30 N (3 kg)
100 (Factory-setting at the time of shipment)	Approx. 40 N (4 kg)	Approx. 60 N (6 kg)



- To avoid personal injury, never put your fingers under the presser foot.
- Be aware that the presser foot pressure varies when the presser foot or the throat plate is changed.

3-6-2. Micro-lifter function

Sewing while lifting the presser foot by very small amount is enabled by inputting a negative value on the panel. The micro-lifter function helps reduce slippage and damage of the material in the case of sewing raised fabric such as velvet.

* Refer to the table shown below for a rough indication of the relation among the value input on the panel, the presser foot height and the presser foot pressure.

Input value on the panel	Presser foot height	Presser foot pressure (Reference)	
		S type	H type
0	0 mm	Approx. 10 N (1 kg)	Approx. 30 N (3 kg)
-350	Approx. 4 mm		

*1 The presser foot height 0 mm means the state the sole of presser foot comes in contact with the top surface of throat plate.

*2 The presser foot pressure becomes constant by inputting a negative value on the panel.

*3 The presser foot pressure varies when the presser foot or the throat plate is changed.

*4 Range of input values on the panel is from -350 to 200.



- Be sure to input a positive value on the operation panel in the case the micro-lifter function is not used. If not, the presser foot is slightly raised and the feed dog is unable to provide a sufficient efficiency of feed.
- In the case of using the micro-lifter function, the efficiency of feed is likely to be insufficient. To achieve the sufficient efficiency of feed, reduce the sewing speed or help feed the material by hand.

**WARNING :**

Turn OFF the power before starting the work so as to prevent accidents caused by abrupt start of the sewing machine.

3-6-3. Changing the initial value of presser foot pressure

If you want to change the initial value of presser foot pressure, it is possible to change the initial presser foot pressure by changing the mounting position of presser bar position bracket (upper) ④.

Carry out adjustment according to the sewing process as needed basis.

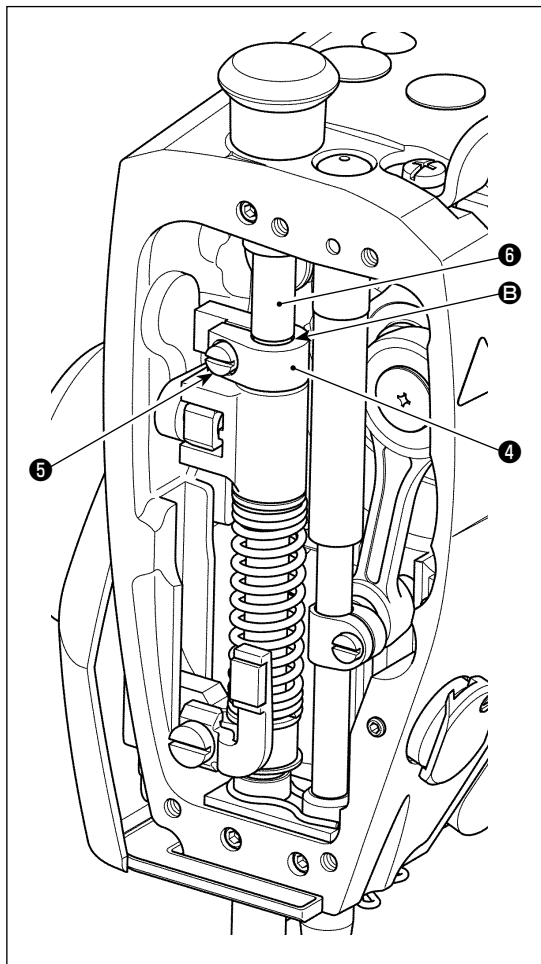
**[How to adjust]**

- 1) Turn OFF the power to the sewing machine.
- 2) Remove the face plate.
- 3) Loosen presser bar position bracket (upper) clamping screw ⑤. Adjust the vertical position of presser bar position bracket (upper) ④ using marker line B on presser bar ⑥ as reference.
* Adjust the orientation of presser bar position bracket (upper) ④ so that it is in parallel with the face plate.
- 4) After the completion of adjustment, tighten presser bar position bracket (upper) clamping screw ⑤ and attach the face plate.

Position of presser bar position bracket (upper) ④ with respect to marker line B on presser bar ⑥	Presser foot pressure (Reference)	
	S type	H type
4 mm above		Approx. 0 N (0 kg)
1 mm above	Approx. 0 N (0 kg)	
0 (just beneath the marker line) (Factory-setting at the time of shipment)	Approx. 10 N (1 kg)	Approx. 30 N (3 kg)
1 mm below	Approx. 20 N (2 kg)	Approx. 40 N (4 kg)

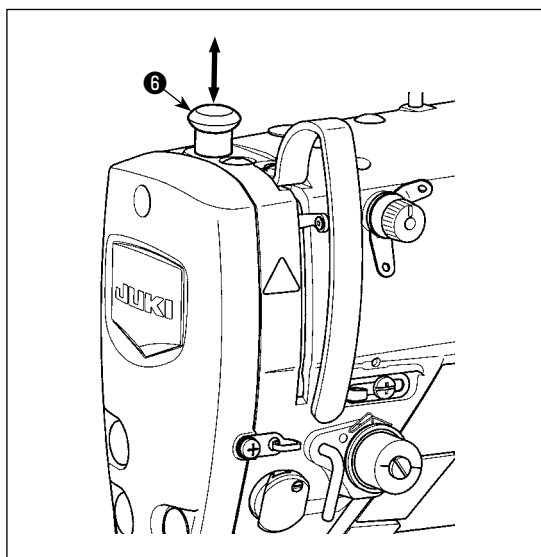

3-6-4. Manual lifter

The presser foot can be manually lifted/lowered by moving presser bar cap ⑥ up and down while the power to the sewing machine is in the OFF state.

Use this manual lifting feature when replacing the gauge or adjusting the needle entry area.

3-7. Adjusting the stitch length



1. There may be the cases where the feed amount of the operation panel and the actual sewing pitch are different from each other in case of the use in the state other than the standard delivery or material used. Compensate the pitch in accordance with the sewing product.
2. Be aware that interference between the throat plate and feed dog can occur depending on the gauge used. Be sure to check the clearance in the gauge to be used. (The clearance must be 0.5 mm or more.)
3. When you have changed the stitch length, feed dog height or feed timing, run the sewing machine at a low speed to make sure that the gauge does not interfere with the changed part.

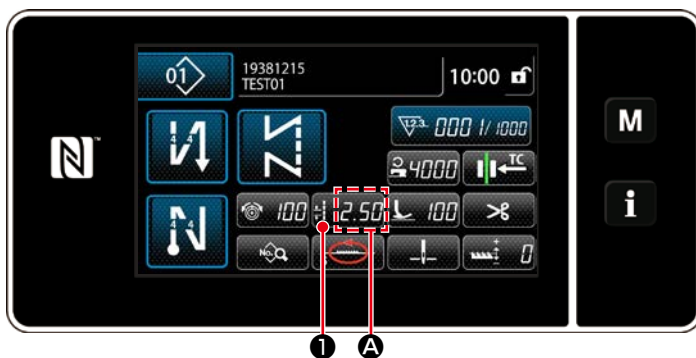

Stitch length is displayed in section **A** on the panel. (Example of display : 2.50 mm)

[How to adjust]

1) Display the stitch pitch entry screen by pressing **2.50** **1**.

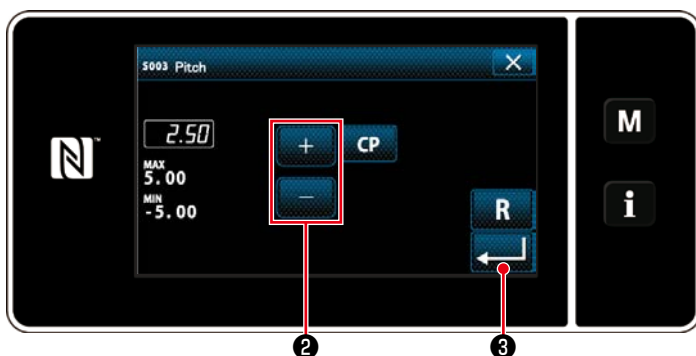

2) The value displayed is changed by pressing **+** **-** **2**. (In increments of 0.05 mm ; Input range : -5.00 to 5.00)

3) Confirm your entry by pressing **↩** **3**. Then, the sewing screen is displayed.

3-8. Changing the sewing speed

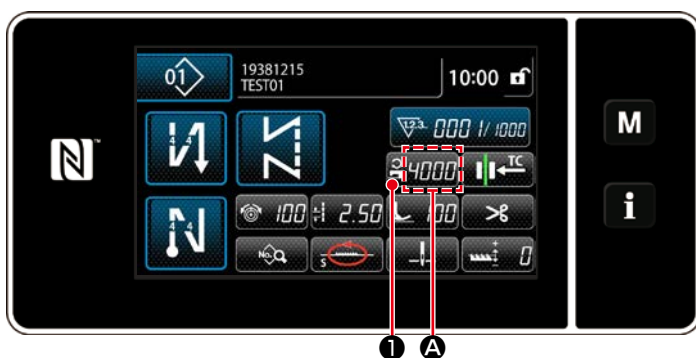

The sewing speed is displayed in section **A** on the panel. (Example of display : 4,000 sti/min)

[How to change]

1) Display the sewing speed entry screen by pressing **4000** **1**.

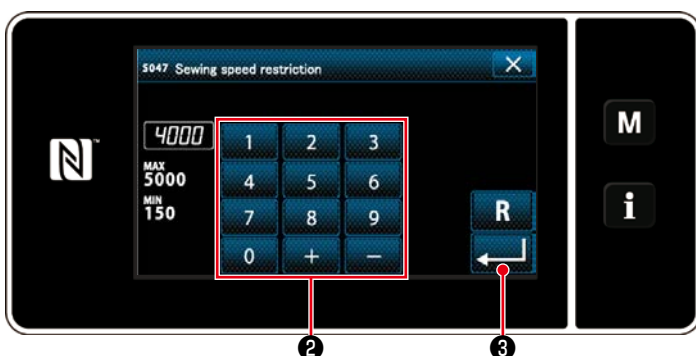

2) Change the sewing speed as desired by pressing ten keys **2**.

3) Confirm your entry by pressing **↩** **3**. Then, the sewing screen is displayed.

3-9. LED hand light



WARNING :

In order to protect against personal injury due to unexpected start of the sewing machine, never bring hands near the needle entry area or place foot on the pedal during the adjustment of intensity of the LED.

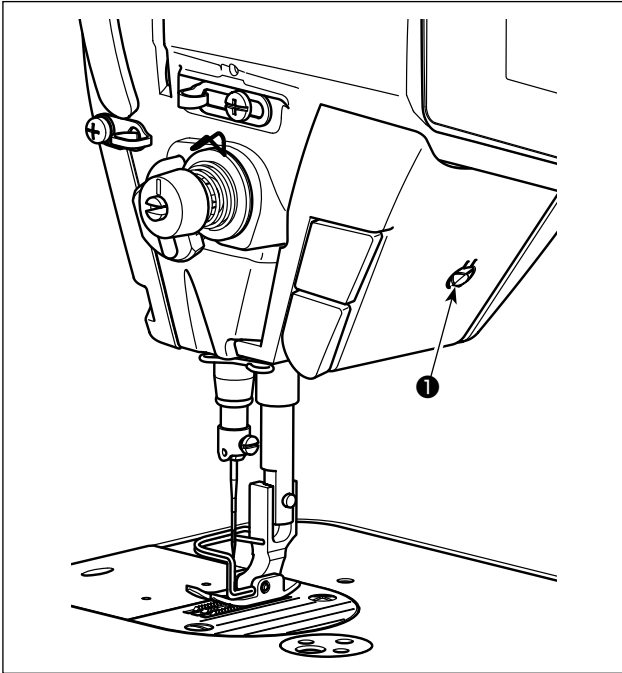

* This LED is intended to improve operability of the sewing machine and is not intended for maintenance.

The sewing machine is provided as standard with an LED light which illuminates the needle entry area. Intensity adjustment and turn-off of the light is carried out by pressing switch ①. Every time the switch is pressed, the light is adjusted in intensity in five steps and is turned off in turn.

[Change of intensity]

1 ⇒ 4 ⇒ 5 ⇒ 1
Bright ⇒ Dim ⇒ Off ⇒ Bright

In this way, every time the switch ① is pressed, the hand lamp status is changed in repetition.

3-10. Reverse feed stitching

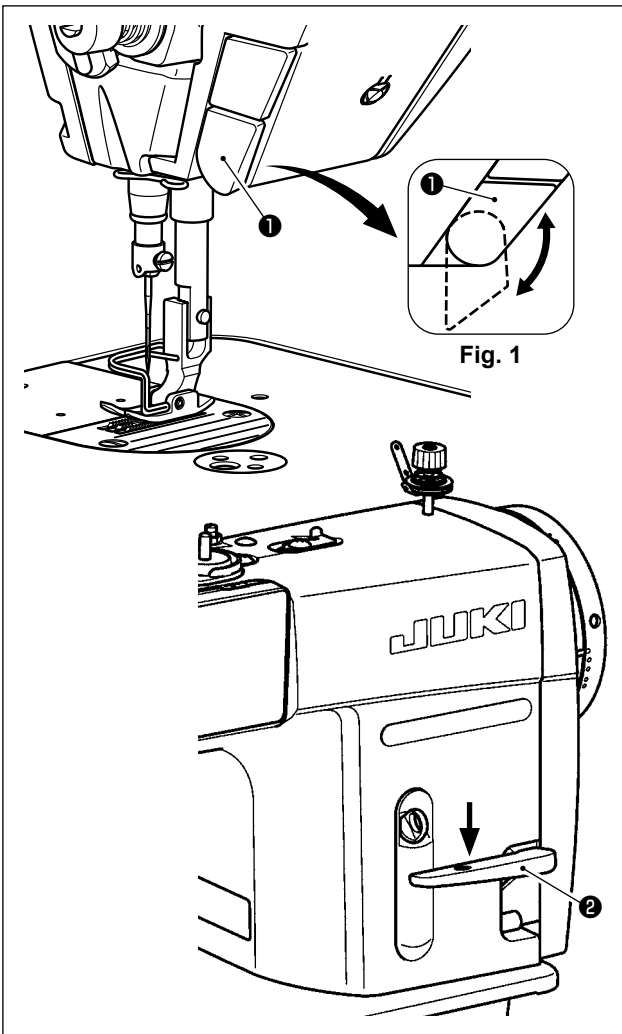

[One-touch type reverse feed stitching mechanism]

The one-touch type reverse feed switch ① is pressed, the machine performs reverse feed stitching.

The machine resumes normal feed stitching the moment the switch lever is released.

[Reverse feed stitching by means of the reverse feed lever]

Length of the seam sewn by feeding the material in the normal or reverse direction of feed can be controlled by operating reverse feed lever ②.

[Adjusting the position of one-touch type reverse feed switch]

One-touch type reverse feed switch ① can be used at two different positions by turning it. (Fig. 1)

3-11. Custom switch

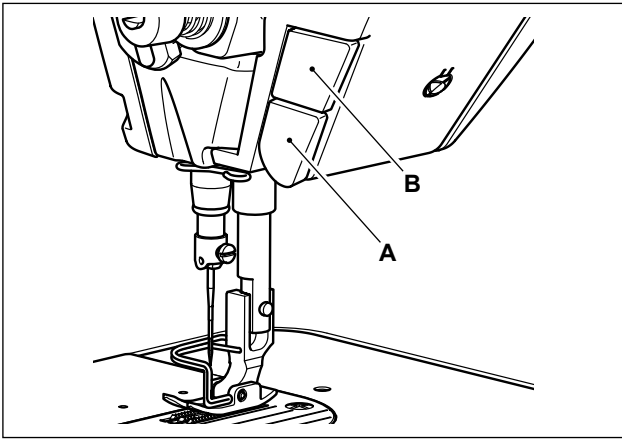

Various operations can be carried out by operating custom switch **B**.

* It is also possible to assign an operation to custom switch **A**.

The initial values are as follows:

Custom switch **A** : Input of reverse feed stitching switch

Custom switch **B** : One-touch changeover switch



- 1) **M** ¹ held pressed for three second.
The "mode screen" is displayed.

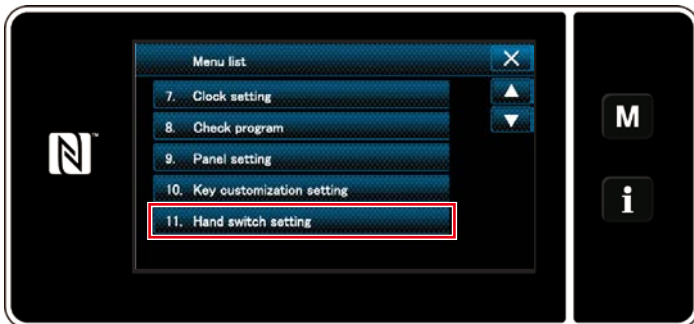

- 2) Select the "11. Hand switch setting".



- 3) Select the switch to be set.

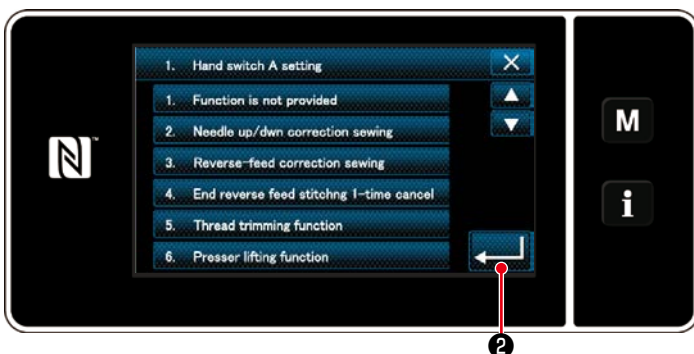

- 4) Select the function item which is to be assigned to the switch, and press  ².

[Description of operations of the custom switch]

	Function item		Function item
1	Optional input function is not provided	12	High speed command input
2	Needle up / down compensating stitching	13	Needle lifting function
3	Back compensating stitching	14	Reverse feed stitching switch input
4	Function of canceling once reverse feed stitching at the end of sewing	15	Soft start switch input
5	Thread trimming function	16	One-shot speed command switch input
6	Presser foot lifting function	17	Backward one-shot speed command switch input
7	One stitch compensating stitching	18	Safety switch input
8	Material edge sensor input	19	Automatic reverse feed stitching cancellation/addition switch
9	Function of prohibiting depressing front part of pedal	20	Sewing counter input
10	Function of prohibiting thread trimming output	21	One-touch type changeover switch
11	Low speed command input		

3-12. Adjusting the amount of oil (oil splashes) in the hook (DDL-9000C-FMS, FSH)

	<p>WARNING : Be extremely careful about the operation of the machine since the amount of oil has to be checked by turning the hook at a high speed.</p>
---	--

3-12-1. Adjusting the amount of oil in the hook

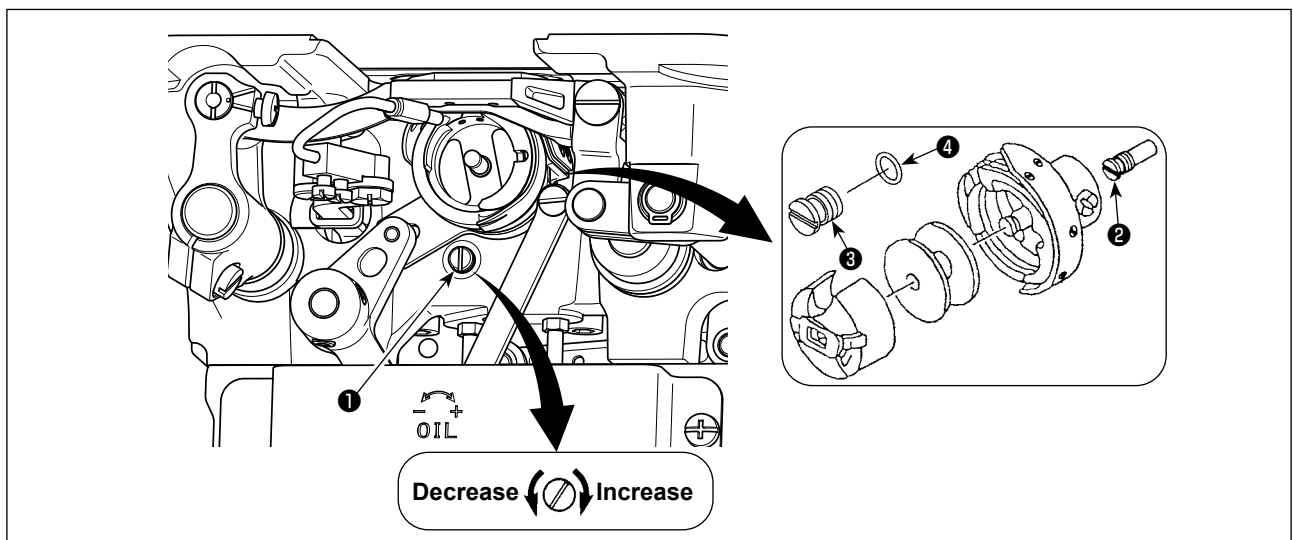

Tighten (turn clockwise) oil amount adjustment screw ❶ to increase the amount of oil in the hook, or loosen (turn counterclockwise) to decrease it.

	<p>"When using RP hook (hook for dry head) for DDL-9000C-FMS type"</p> <ol style="list-style-type: none"> 1. Remove hook driving shaft oil wick setscrew ❷ and attach hook driving shaft stopper screw ❸ (part number : 11079506) and rubber ring ❹ (part number : RO036080200). 2. Loosen oil amount adjustment screw ❶ up to the minimum so as to reduce the oil amount in the hook. However, do not completely stop the oil and be careful not to allow oil adjustment screw ❶ to come off. 3. <u>Never drain the oil in the oil tank even when RP hook (hook for dry head) is used.</u>
---	---

3-12-2. How to confirm the amount of oil (oil splashes)

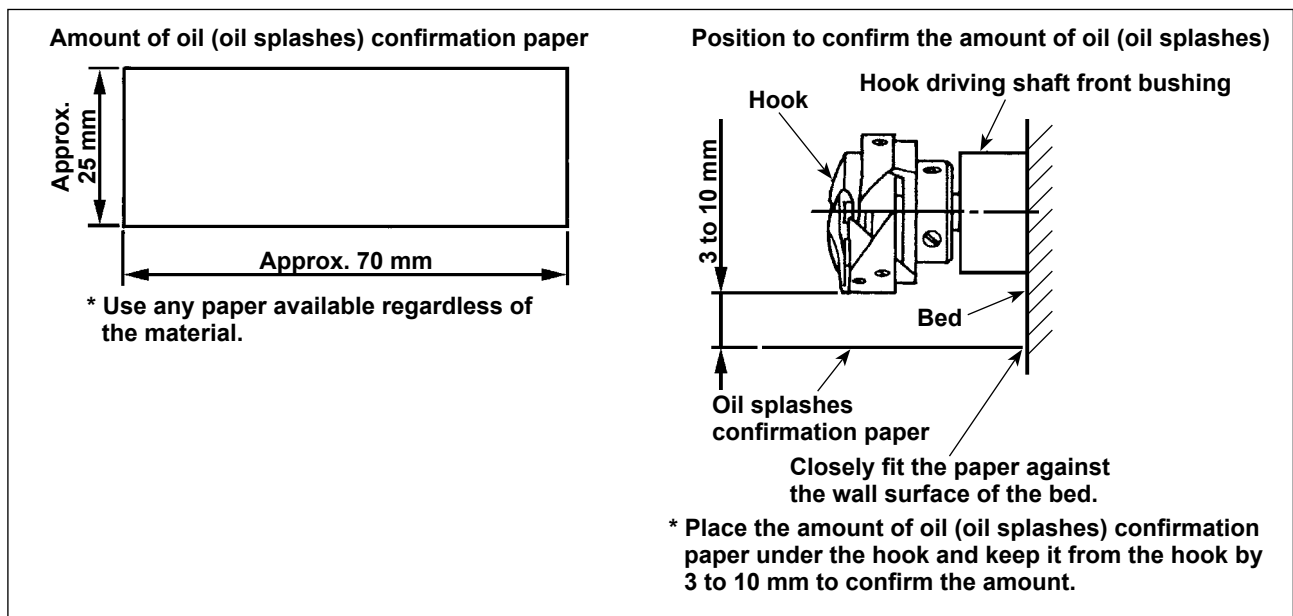

- * In the case of measuring the oil quantity in the hook, measure it under the "Bobbin winding mode". Refer to "3-3. Winding the bobbin thread [Bobbin winding mode]" p.18 for the bobbin winding mode.
 - * When carrying out the procedure described below in 2), confirm the state that the needle thread from the thread take-up lever to the needle and the bobbin thread are removed, the presser foot is lifted and the slide plate is removed. At this time, take extreme caution not to allow your fingers to come in contact with the hook.
- 1) If the machine has not been sufficiently warmed up for operation, make the machine run idle for approximately three minutes. (Moderate intermittent operation)
 - 2) Place the amount of oil (oil splashes) confirmation paper under the hook while the sewing machine is in operation.
 - 3) Confirm that oil exists in the oil tank.
 - 4) Confirmation of the amount of oil should be completed in five seconds. (Check the period of time with a watch.)

3-12-3. Sample showing the appropriate amount of oil

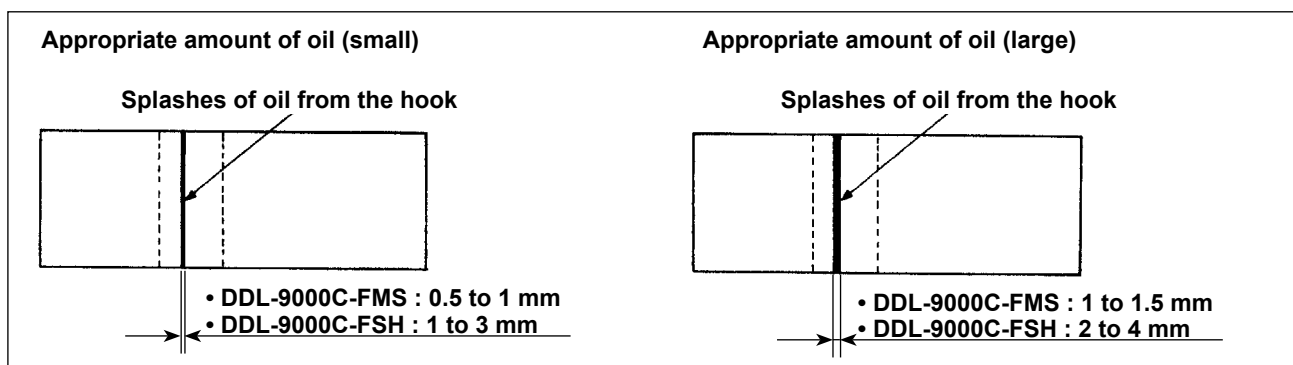

- 1) The state given in the figure above shows the appropriate amount of oil (oil splashes). It is necessary to finely adjust the amount of oil in accordance with the sewing processes. However, do not excessively increase/decrease the amount of oil in the hook. (If the amount of oil is too small, the hook will be seized (the hook will be hot). If the amount of oil is too much, the sewing product may be stained with oil.)
- 2) Check the oil amount (oil splashes) three times (on the three sheets of paper), and adjust so that it should not change.

3-13. Adjusting the thread take-up spring and the thread take-up stroke

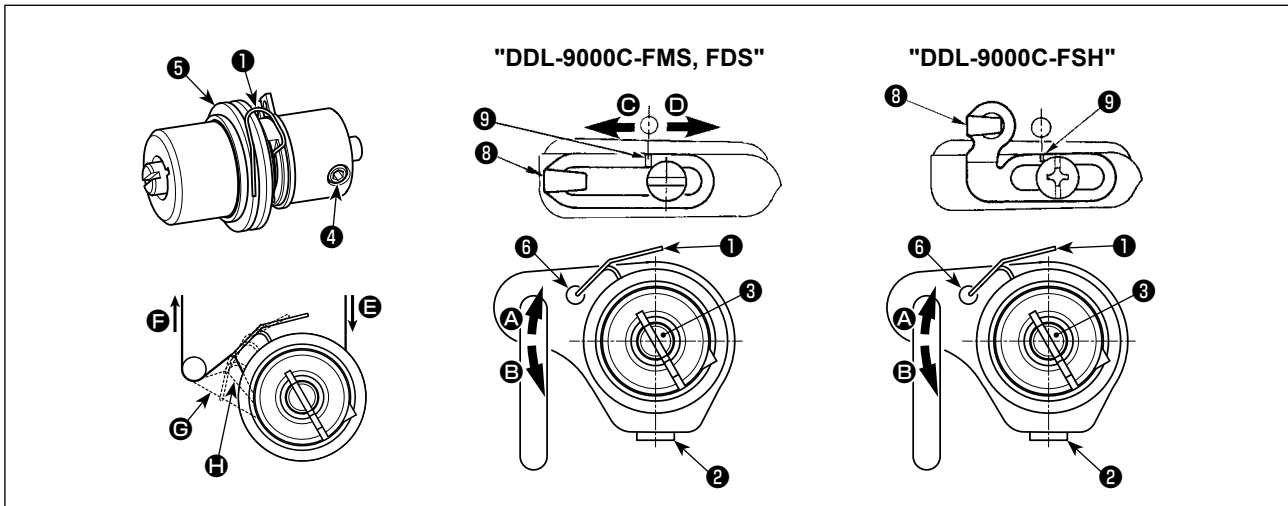

(1) Adjusting the stroke of thread take-up spring ①

- 1) Loosen setscrew ②.
- 2) Turn tension post ③ clockwise (in direction A), the stroke of the thread take-up spring will be increased, and turn the post ③ counterclockwise (in direction B), the stroke will be decreased.

(2) Adjusting the pressure of thread take-up spring ①

- 1) Loosen setscrew ②, and remove thread tension (asm.) ⑤.
- 2) Loosen tension post setscrew ④.
- 3) Turn tension post ③ clockwise (in direction A), the pressure will be increased, and turn the post ③ counterclockwise (in direction B), the pressure will be decreased.

* Standard state of the thread take-up spring ①

The engraved marker line ⑥ on the machine arm is almost aligned with the top of thread take-up spring. (It is necessary to adjust in accordance with materials and processes.)



To check how the thread take-up spring works, draw out the needle thread in direction F after having adjusted the thread take-up spring pressure to check whether the thread take-up spring exerts force to the thread up to the last moment (state E) just before the thread comes out from E. If the spring fails to exert force to the spring until the last moment (state H), decrease the thread take-up spring pressure. In addition, the stroke of the thread take-up spring is excessively small, the spring does not work properly. For the general fabrics, a stroke of 10 to 13 mm is proper.

(3) Adjusting the thread take-up stroke

- 1) When sewing heavy-weight materials, move thread guide ⑧ to the left (in direction C) to increase the length of thread pulled out by the thread take-up.
- 2) When sewing light-weight materials, move thread guide ⑧ to the right (in direction D) to decrease the length of thread pulled out by the thread take-up.

* Standard state of the thread guide

- DDL-9000C-FMS, FDS : Marker line ⑨ on the thread guide aligns with the center of the setscrew.
- DDL-9000C-FSH : Marker line ⑨ on the thread guide aligns with the center of the marker line on the machine arm.

4. HOW TO USE THE OPERATION PANEL

4-1. Explanation of the sewing screen (when selecting a sewing pattern)

On the sewing screen, the shape and set values of the currently-sewn sewing pattern are displayed. The display and button operation differ according to the selected sewing pattern.

Note that the sewing screen shows two different displays, i.e., the sewing pattern display and the counter display.

Refer to "[4-3. Counter function](#)" p. 58 for the description of the counter display.

There are two different screen display modes; i.e., **<Operator mode>** and **<Maintenance personnel mode>**.



The mode can be changed over between the operator mode and the maintenance personnel mode by simultaneously pressing **M** ① and **i** ②.

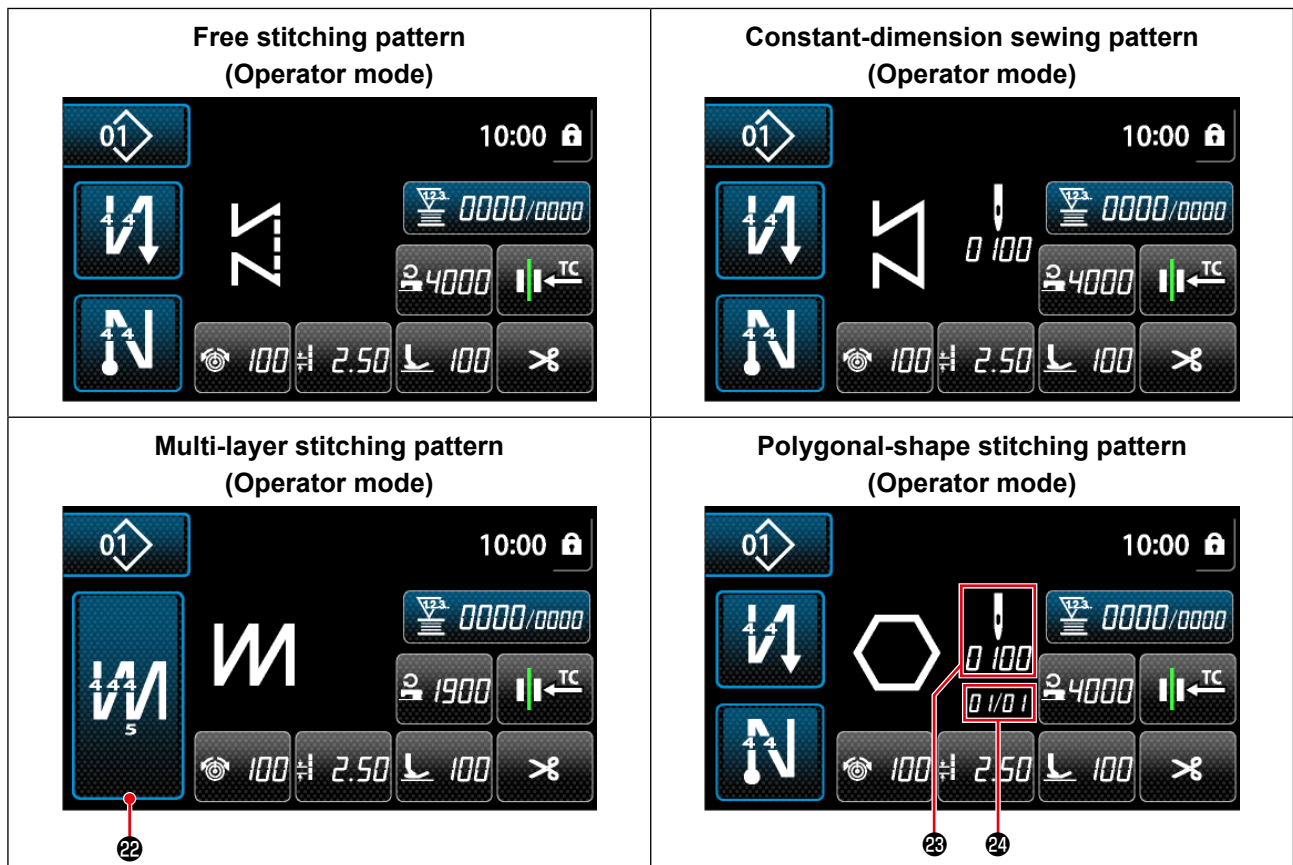
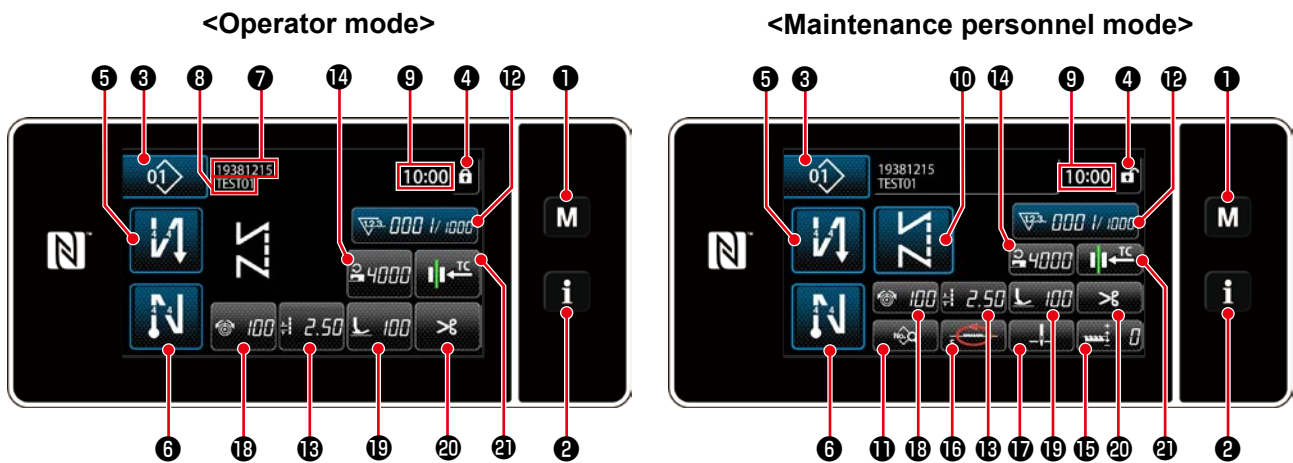

(1) Sewing screen (when selecting a sewing pattern)

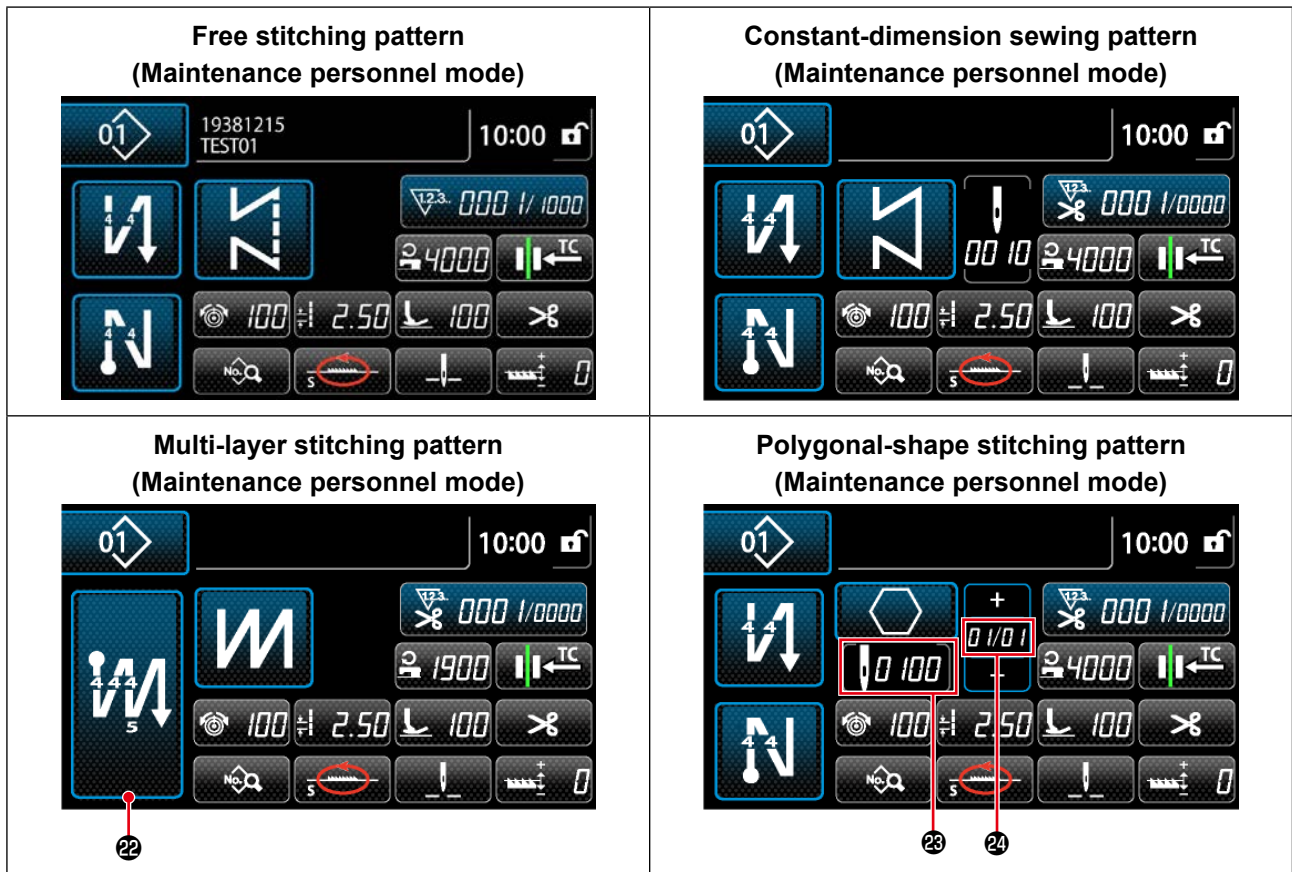
A sewing pattern can be selected with **N** ⑩. Four different stitch shapes are available as shown below.





	Switch/display	Description
❶	Mode key	This switch is used for displaying the menu screen. Level 1 is displayed by pressing this switch in the normal manner. Level 2 or Level 3 is displayed by keeping this switch held pressed for three seconds or more for the former or six seconds or more for the latter. The mode is changed over between the operator mode and maintenance personnel mode by pressing the Mode key and the Information key simultaneously.
❷	Information key	This switch is used for displaying the information screen. Level 1 or Level 2 is displayed by pressing this switch in the normal manner for the former or by keeping it held pressed for three seconds or more for the latter. The mode is changed over between the operator mode and maintenance personnel mode by pressing the Information key and the Mode key simultaneously.
❸	Sewing pattern No. button	Sewing pattern list screen is displayed. The currently-selected sewing pattern number is displayed on this button. (P01 – P99)
❹	Simplified screen lock button	This is button is used for changing over the operation status of buttons displayed on the screen between enable and disable. This button is used for displaying the simplified lock status of the screen on it. Locked:  Unlocked:  Once the button operation is locked using the simplified screen lock button, operation of the buttons displayed on the screen, excluding this button will be disabled.

	Switch/display	Description
⑤	Sewing-start reverse-feed stitch button	This switch is used for changing the ON/OFF status of the reverse feed stitching at the beginning of sewing. When reverse feed stitching at the beginning of sewing is placed in the OFF state,  mark is displayed at the upper left of the button. The reverse feed stitching (at start) edit screen is displayed by keeping this key held pressed for one second. → This button is displayed for free stitching, constant-dimension sewing or polygonal-shape stitching.
⑥	Sewing-end reverse-feed stitch button	This switch is used for changing the ON/OFF status of reverse feed stitching at the end of sewing. When reverse feed stitching at the end of sewing is placed in the OFF state,  mark is displayed at the upper left of the button. The reverse feed stitching (at end) edit screen is displayed by keeping this key held pressed for one second. → This button is displayed for free stitching, constant-dimension sewing or polygonal-shape stitching.
⑦	Part number	The part number is displayed in this field.
⑧	Process/comment	The process or comment is displayed in this field.
⑨	Clock display	The time set on the sewing machine is displayed in this field in 24-hour system.
⑩ *	Pattern shape button	Selected sewing pattern is displayed on this screen. Four different sewing patterns are available, i.e., free stitching pattern, constant-dimension sewing pattern, multi-layer stitching pattern and polygonal-shape stitching pattern. The shape selection screen is displayed by pressing this button.
⑪ *	Sewing data list button	A selected function can be allocated to and registered with this button. In the initial state, "sewing data edit screen" is displayed. Refer to "4-2-6. List of pattern functions" p. 46.
⑫	Customization button	A selected function can be allocated to and registered with this button. This button has been initially set to the "sewing counter". Refer to "4-2-6. List of pattern functions" p. 46.
⑬	Customization button	A selected function can be allocated to and registered with this button. This button has been initially set to the "pitch". Refer to "4-2-6. List of pattern functions" p. 46.
⑭	Customization button	A selected function can be allocated to and registered with this button. This button has been initially set to the "sewing speed". Refer to "4-2-6. List of pattern functions" p. 46.
⑮ *	Customization button	A selected function can be allocated to and registered with this button. This button has been initially set to the "correction of feed dog height". Refer to "4-2-6. List of pattern functions" p. 46.
⑯ *	Customization button	A selected function can be allocated to and registered with this button. This button has been initially set to the "feed locus". Refer to "4-2-6. List of pattern functions" p. 46.
⑰ *	Customization button	A selected function can be allocated to and registered with this button. This button has been initially set to the "stop position of needle bar". Refer to "4-2-6. List of pattern functions" p. 46.
⑱	Customization button	A selected function can be allocated to and registered with this button. This button has been initially set to the "needle thread tension". Refer to "4-2-6. List of pattern functions" p. 46.
⑲	Customization button	A selected function can be allocated to and registered with this button. This button has been initially set to the "presser foot pressure". Refer to "4-2-6. List of pattern functions" p. 46.

	Switch/display	Description
⑳	Customization button	A selected function can be allocated to and registered with this button. This button has been initially set to the "prohibition of thread trimming". Refer to "4-2-6. List of pattern functions" p. 46.
㉑	Customization button	A selected function can be allocated to and registered with this button. This button has been initially set to the "feed timing". Refer to "4-2-6. List of pattern functions" p. 46.
㉒	Multi-layer stitching button	The multi-layer stitching setting screen is displayed by keeping this button held pressed for one second. Refer to "4-2-5. Editing the sewing patterns" p. 44. → This button is displayed when multi-layer stitching is selected.
㉓	Number of stitches	This button is used for displaying the number of stitches of constant-dimension sewing or the number of stitches registered for each step of polygonal-shape stitching. → This button is displayed when constant-dimension sewing or polygonal-shape stitching is selected.
㉔	Display of the number of steps of a polygonal-shape stitching pattern	This button is displayed when constant-dimension sewing or polygonal-shape stitching is selected (1 to 20). → This button is displayed when polygonal-shape stitching is selected.

* Only in the case the maintenance personnel mode is selected.

4-2. Sewing patterns

Patterns which are frequently sewn can be registered as sewing patterns.

Once the patterns are registered as sewing patterns, the desired sewing pattern can be called up only by selecting its sewing pattern number.

As many as 99 different patterns can be registered as sewing patterns.

4-2-1. Sewing pattern configuration

One sewing pattern consists of four elements, i.e., reverse feed stitching (at start), main stitching, reverse feed stitching (at end) and pattern function.

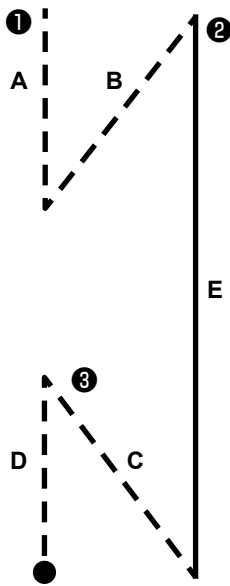

Pattern No. 1 - No. 99	
①	Reverse feed stitching (at start) section Refer to "4-2-3. Reverse feed stitching (at start) pattern" p. 38.
②	Main stitching section <ul style="list-style-type: none"> · Free stitching · Constant-dimension sewing · Multi-layer stitching · Polygonal-shape stitching Refer to "4-2-5. Editing the sewing patterns" p. 44 and "8-2. Setting up the polygonal-shape stitching" p. 105.
③	Reverse feed stitching (at end) section Refer to "4-2-7. Reverse feed stitching (at end) pattern" p. 49.
④	Pattern function Refer to "4-2-5. Editing the sewing patterns" p. 44.

4-2-2. List of sewing patterns

The list of stored sewing patterns are displayed on the screen. Under the maintenance personnel mode, sewing patterns can be created, copied and deleted.

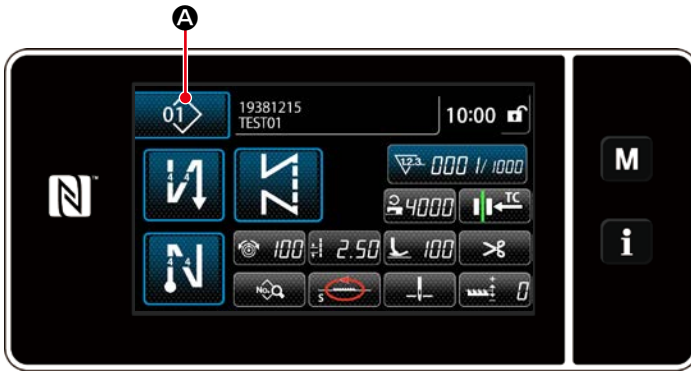

<Sewing screen (operator mode)>

Press  **A** on the sewing screen of each mode.

The sewing pattern number list screen is displayed.

<p>Pattern list screen: In numerical order (Operator mode)</p>	<p>Pattern list screen: In alphabetical order (Operator mode)</p>
<p>Pattern list screen: In numerical order (Maintenance personnel mode)</p>	<p>Pattern list screen: In alphabetical order (Maintenance personnel mode)</p>

	Name	Function
①	Pattern No. button	This button is used for displaying numbers of the registered sewing patterns and cycle patterns. (Cycle pattern numbers that are not registered are not displayed.) When this button is pressed, the sewing pattern is put into the selected state. Display range: Sewing pattern numbers 1 to 99 and cycle patterns 1 to 9.
②	Registered character button	Sewing pattern is displayed and the pattern is put into the selected state by pressing this button.
③	Sorting button	This button is used for sorting the registered patterns in the order of sewing pattern number, process, part number or comment.
④	Refining button	This button is used for displaying the refiner setting screen.
⑤	New sewing pattern creation button	This button is used for creating a new sewing pattern. Refer to "8-1-1. Creation of a new pattern" p. 101. * This button is only displayed under the maintenance personnel mode.
⑥	New cycle pattern creation button	This button is used for creating a new cycle pattern. Refer to "8-3. Cycle pattern" p. 108. * This button is only displayed under the maintenance personnel mode.
⑦	Pattern copy button	This button is used for copying a sewing pattern or cycle pattern and registering the copied pattern with new number. Refer to "8-1-2. Copying a pattern" p. 103. * This button is only displayed under the maintenance personnel mode.
⑧	Pattern delete button	This button is used for displaying the pattern deletion confirmation message. In the case there is only one registered pattern, the pattern cannot be deleted. * This button is only displayed under the maintenance personnel mode.
⑨	Scroll (up) button	This button is used for displaying the previous page.
⑩	Scroll (down) button	This button is used for displaying the next page.
⑪	Close button	This button is used for cancelling the selected pattern and displaying the sewing screen.
⑫	Enter button	This button is used for confirming the selected pattern and displaying the sewing screen.
⑬	Display of pattern data being selected	This button is used for displaying data on the pattern that is being selected.

4-2-3. Reverse feed stitching (at start) pattern

A stitch shape of the reverse feed stitching (at start) is set by following the steps of procedure described below.

(1) Enabling the reverse feed stitching (at start) pattern



The sewing-start reverse feed stitching pattern can be operated when the sewing-start reverse feed stitching function is placed in the ON state (no 'X' mark is not displayed). If this function is placed in the OFF state, press the sewing start reverse feed stitch button to switch off 'X' mark display to enable the sewing-start reverse feed stitching function.

(2) Changing the number of stitches and pitch of reverse feed stitching (at start) pattern (In the case of operator mode)

① Displaying the edit screen for reverse feed stitching (at start)



 ① held pressed for one second. The reverse feed stitching (at start) edit screen is displayed.

② Setting the shape, the number of stitches and pitch of reverse feed stitching (at start)

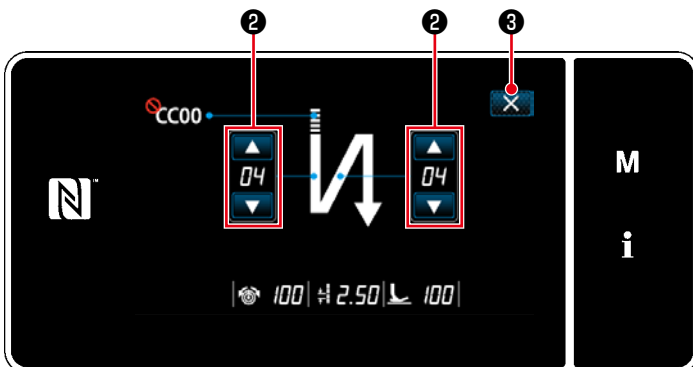







Change the numeric value with  ②.

The value you have entered is confirmed by pressing  ③. Then, the sewing screen is displayed.

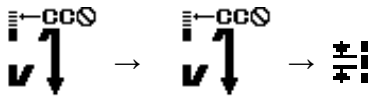
<Edit screen for reverse feed stitching (start) (operator mode)>

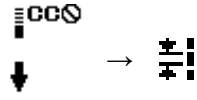
"Type of stitch" and "edit item" that can be selected are as follows:

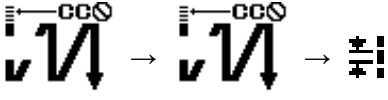

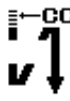
Type of stitch	Edit item
<p>Reverse feed stitching </p> <p>Reverse feed stitching is performed once at the beginning of sewing.</p>	<p>Number of stitches A Number of stitches B Pitch</p> 
<p>Condensation </p> <p>Stitch pitch at the beginning of sewing is reduced.</p>	<p>Number of stitches A Pitch</p> 
<p>Double reverse feed stitching </p> <p>Reverse feed stitching is performed twice at the beginning of sewing.</p>	<p>Number of stitches A Number of stitches B Pitch</p> 
<p>Condensation custom </p> <p>The number of stitches and pitch of condensation can be set as desired.</p>	<p>Condensation custom No.</p> 

◆ For the maintenance personnel mode

① Display the sewing-start reverse-feed stitching edit screen and set up a shape

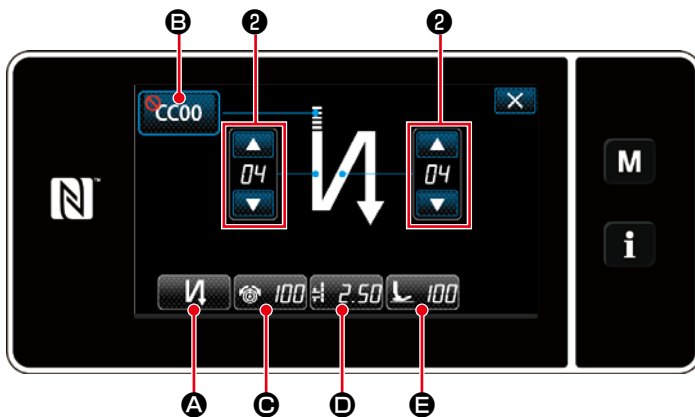

<Sewing-start reverse-feed stitching screen (maintenance personnel mode)>



1. Display the sewing-start reverse-feed stitching edit screen referring to the case of the operator mode.
2. Change the number of stitches of sewing-start reverse-feed stitching with .

② .

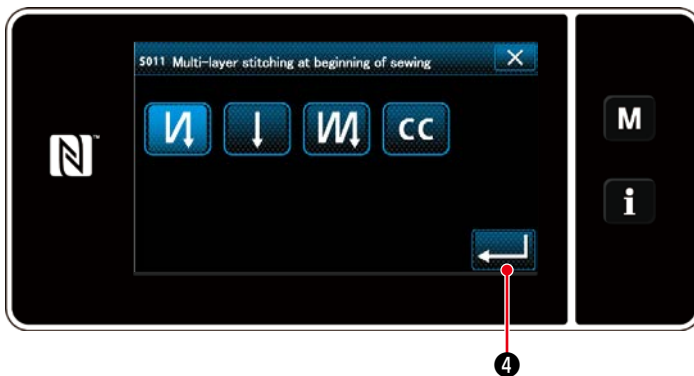
• Selecting the type of sewing-start reverse-feed stitching (A)





<Type of reverse-feed stitching input screen>

1. Press  (A). Then, the type of reverse-feed stitching input screen is displayed. Select the desired type of sewing-start reverse-feed stitching pattern from four different types; i.e., reverse-feed stitching (single), condensation stitching, double reverse-feed stitching and Condensation custom.
2. Press  (4) to confirm the aforementioned operation and return the current screen to the sewing-start reverse-feed stitching screen.

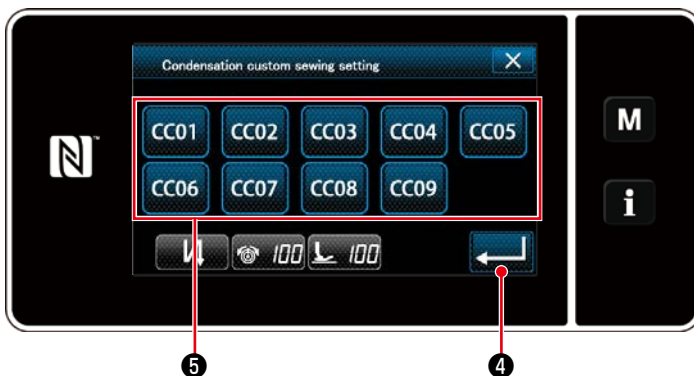
• Selecting the condensation custom (B)



<Condensation custom selection screen>

1. Press  (B). Then, the condensation custom selection screen is displayed.
- * In the case the condensation custom button is not used,  mark is displayed.
2. Press button (5) to select the condensation custom.
3. Press  (4) to confirm the aforementioned operation and return the current screen to the sewing-start reverse-feed stitching screen.

• Inputting the needle-thread tension value (Ⓢ)

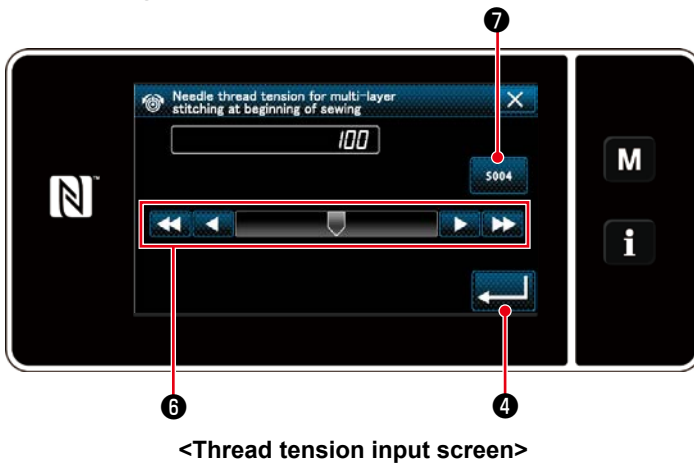

1. Press Ⓢ. Then, the thread tension input screen is displayed. Input a thread tension (0 to 200) with button **6**.
- * Ⓢ is not displayed when **7** is selected.
2. Press **4** to confirm the aforementioned operation and display the sewing-start reverse-feed stitching screen.

• Inputting the pitch (Ⓢ)

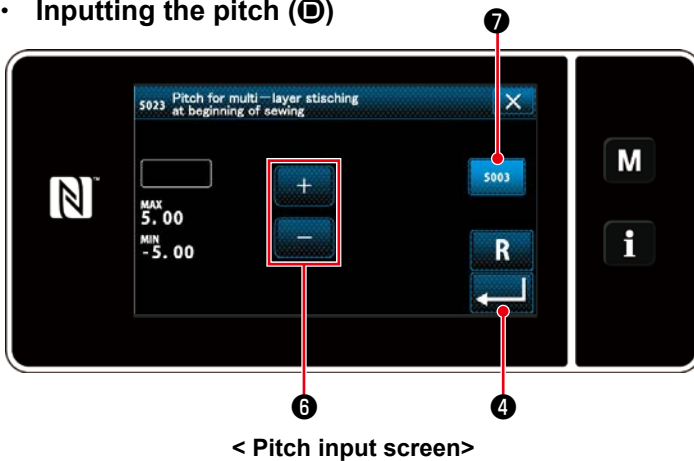

1. Press Ⓢ. Then, the pitch input screen is displayed. Input a pitch (-5.00 to 5.00) with button **6**.
- * Ⓢ is not displayed when **7** is selected.
2. Press **4** to confirm the aforementioned operation and display the sewing-start reverse-feed stitching screen.

• Inputting the presser foot pressure (Ⓢ)

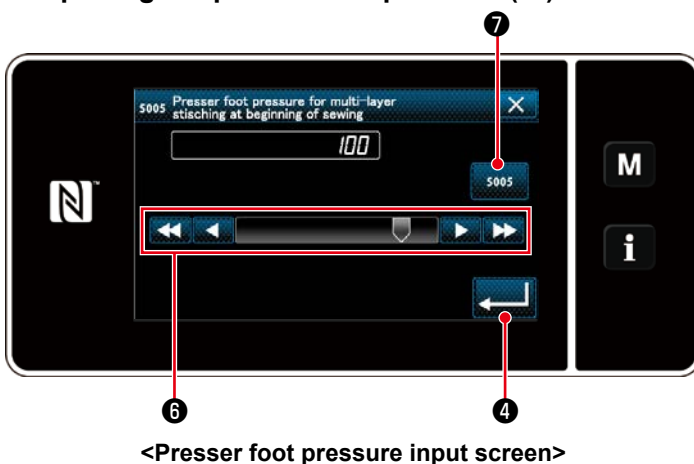

1. Press Ⓢ. Then, the presser foot pressure input screen is displayed. Input a presser foot pressure with button **6**. (-10 to 200)
- * Ⓢ is not displayed when **7** is selected.
2. Press **4** to confirm the aforementioned operation and display the sewing-start reverse-feed stitching screen.

② Applying the changed items

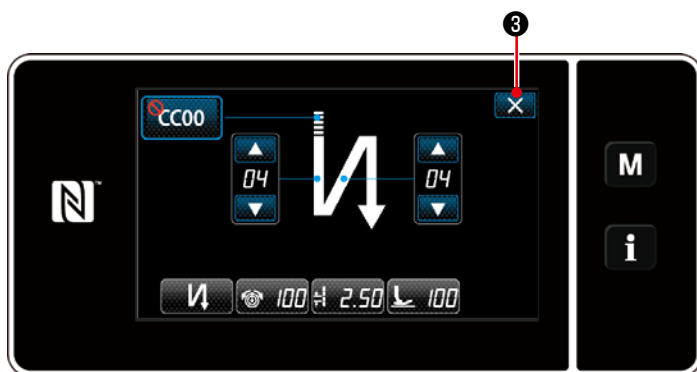

<Sewing-start reverse-feed stitching screen
(maintenance personnel mode)>

Press  ③ to confirm the aforementioned operation and return the current screen to the sewing screen.

4-2-4. Double reverse-feed stitch

Configuring the double reverse-feed stitching pattern shape.

① Displaying the double reverse-feed stitching setting screen

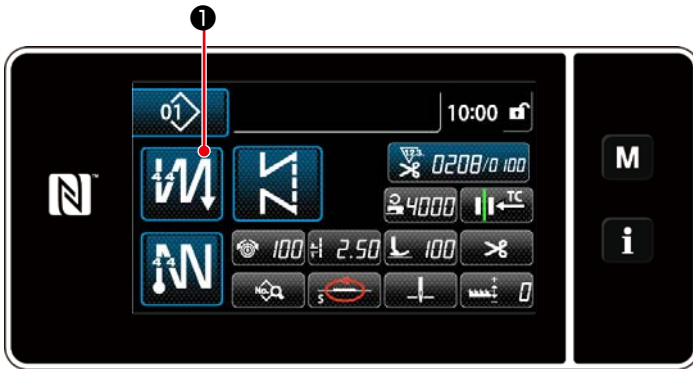



<Sewing screen>

Keep  ① held pressed for one second on the screen which appears when a double reverse feed stitching pattern is selected to display the double reverse feed stitching edit screen.

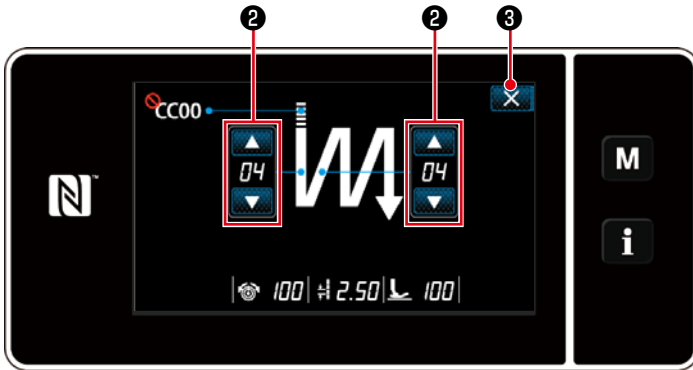
② Configuring the double reverse-feed stitching pattern shape



<Double reverse-feed stitching edit screen (operator mode)>

1. Set the number of stitches with  ② .
2. Press  ③ to confirm the set value and return the current screen to the sewing screen.

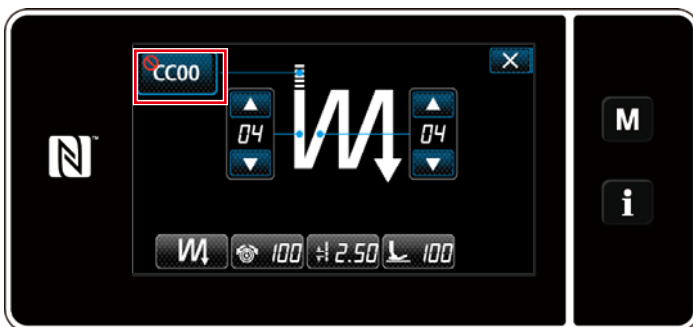

<Double reverse-feed stitching edit screen (maintenance personnel mode)>

Under the maintenance personnel mode, the condensation custom can be set in addition to the aforementioned types of stitching. (In the case of setting data for using the condensation custom)
Set up the condensation custom referring to "4-2-3. (2) ◆ For the maintenance personnel mode" p.40.

4-2-5. Editing the sewing patterns

(1) Edit method (in the case free stitching, constant-dimension sewing or multi-layer stitching is selected)

* In the case polygonal-shape stitching is selected, refer to **"8-2. Setting up the polygonal-shape stitching"** p. 105.

① Displaying the sewing data edit screen



①
<Sewing screen>

On the sewing screen which is displayed in the case free stitching, constant-dimension sewing or multi-layer stitching is selected, press  ① to display the sewing data edit screen.

② Editing the sewing pattern



<Sewing data edit screen>

On this screen, the pattern functions can be edited separately.

Refer to **"4-2-6. List of pattern functions"** p. 46 for the function items that can be edited.

Change the respective items and press



to confirm the change.

Press  ② to display the sewing screen.

③ Performing sewing using the edited sewing pattern



<Sewing screen>

Data you have changed is displayed on the screen.

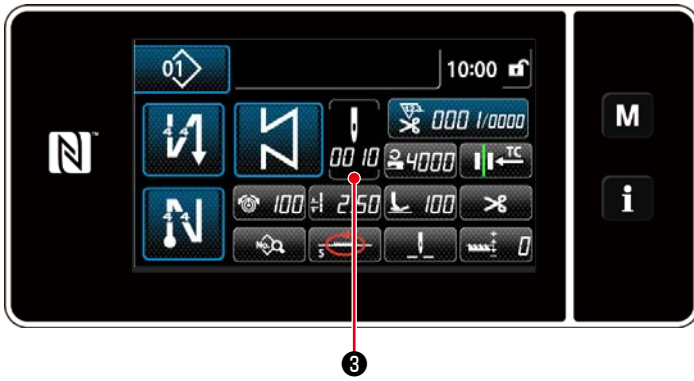

* In the case a constant-dimension sewing pattern is selected, the number of stitches input screen is displayed by pressing  ③ at the time of setting the number of stitches. (Only in the case the number of stitches can be changed)
Refer to "4-2-8. Teaching function" p. 50 for the teaching function.

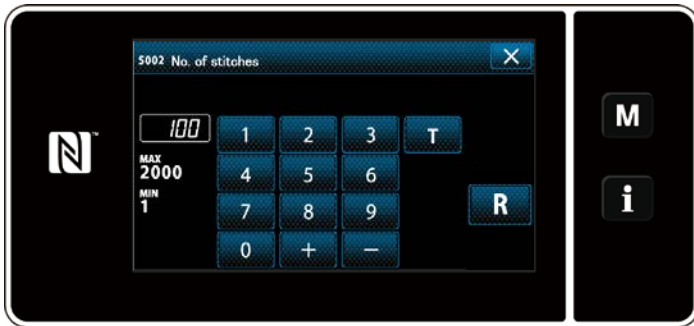



<Number of stitches input screen>

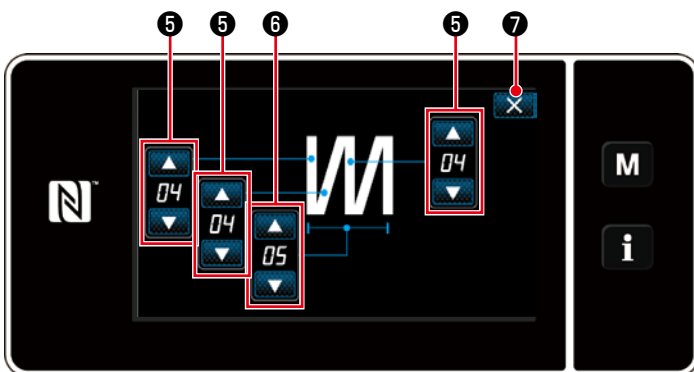

* When a multi-layer stitching pattern is selected, the multi-layer stitching pattern edit screen is displayed by keeping  ④ held pressed for one second.





































<Multi-layer stitching edit screen>

1. Set the number of stitches with  ⑤ .
2. Set the number of times of double reverse feed stitching with  ⑥ .
3. Press  ⑦ to confirm the set value and return the current screen to the sewing screen.

4-2-6. List of pattern functions

(1) Setting items under the pattern sewing mode







Data No.	Item name	Input range			
S001	Shape	Free 	Constant dimension 	Multi-layered 	Polygonal shape 
S002	Number of stitches/ Number of times	—	1 to 2000	1 to 15	—
S003	Pitch	-5.00 to 5.00 / Custom pitch No.1 to 20			—
S004	Thread tension	0 to 200			
S005	Presser foot pressure	-350 to 200			
S041	Stop position of needle bar	 : Stop with the needle down  : Stop with the needle up			—
S042	Thread presser	 : OFF /  : ON			
S043	Prohibition of thread trimming	 : OFF /  : ON			
S044	One-shot	—	 : OFF  : ON	—	—
S045	Thread trimming after one-shot	—	 : OFF  : ON	—	 : OFF  : ON
S046	Shorter-thread remaining	 : OFF /  : ON			
S047	Limit on sewing speed	150 to U096			—
S048	Feed locus	 -  -  - 			
S049	Feed timing	-30 to 30°			
S050	Correction of feed dog height	-4 to 8			—
S051	Correction value for stitch pitch of reverse feed stitching	-5.00 to 5.00			
S052	Multi-layered part detection sensor value	1000 to 3000			
S053	Number of stitches to start sewing after the detection of multi-layered part	0 to 200			

Data No.	Item name	Input range		
S061 *1	Limit on sewing speed	150 to U096 / Common setting S047	—	150 to U096 / Common setting S047
S062 *1	Pitch	-5.00 to 5.00 / Common setting S003	—	-5.00 to 5.00 / Common setting S003
S063 *1	Thread tension	0 to 200		
S064 *1	Presser foot pressure	-350 to 200		
S065 *1	Correction of feed dog height	-4 to 8	—	-4 to 8
S066 *1	Feed locus	S  / A  / C  / B 	—	S  / A  / C  / B 
S067	Needle thread tension correction	  : OFF /   : ON		
S068 *2	Part number	- 24 characters		
S069 *2	Process	- 24 characters		
S070 *2	Comment	50 characters		

*1. This is the one-touch type changeover function. Refer to "4-2-9. One-touch utility changeover function" p. 52.

*2. Only the limited number of characters is displayed.

(2) Setting items for the polygonal-shape stitching steps

Step 1		
	Item name	Input range
S071	Number of stitches	1 to 2000
S072	Pitch	-5.00 to 5.00 / Custom pitch No.1 to 20
S073	Thread tension	0 to 200
S074	Presser foot pressure	-350 to 200
S075	Correction of feed dog height	-4 to 8
S076	Stop position of needle bar	 : Stop with the needle down  : Stop with the needle up  : Thread trimming  : Continuity
S077	Stop position of presser foot	0 to 15.0 mm
S078	One-shot	 : OFF /  : ON
S079	Limit on sewing speed	150 to U096
↓		
Step 2		

* Setting items and the input range are same as those of step 1.

* Step numbers can be set to Step 20.



After you have changed the setting, check to make sure that the feed dog does not come in contact with the throat plate.

Be aware that the stitch pitch may change if you have changed the locus or the feed dog height. It is, therefore, necessary to carry out trial stitching first before using the machine for production.

4-2-7. Reverse feed stitching (at end) pattern

A stitch shape of reverse feed stitching (at end) is set by following the steps of procedure described below.

(1) Enabling the reverse feed stitching (at end) pattern

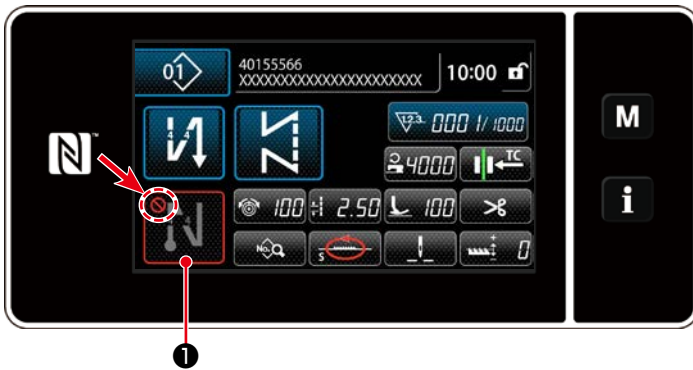

The sewing-end reverse feed stitching pattern can be operated when the sewing-end reverse feed stitching function is placed in the ON state (⊘ mark is not displayed). If this function is placed in the OFF state press the sewing end reverse feed stitch button to switch off ⊘ mark display to enable the sewing-end reverse feed stitching function.

In the case the reverse feed stitching or double reverse feed stitching is selected, number of stitches **A** is displayed on the left side and number of stitches **B** is displayed on the right side on ①, and in the case the condensation stitching is selected, only number of stitches **A** is displayed on (display range: 0 to 99). In the case the condensation custom is selected, the condensation custom number is displayed on .

(2) Changing the number of stitches and pitch of reverse feed stitching (at end) pattern

① Displaying the edit screen for reverse feed stitching (at end)



Keep ① held pressed for one second. The reverse feed stitching (at end) edit screen is displayed.

② Setting the shape, the number of stitches and pitch of reverse feed stitching (at end)

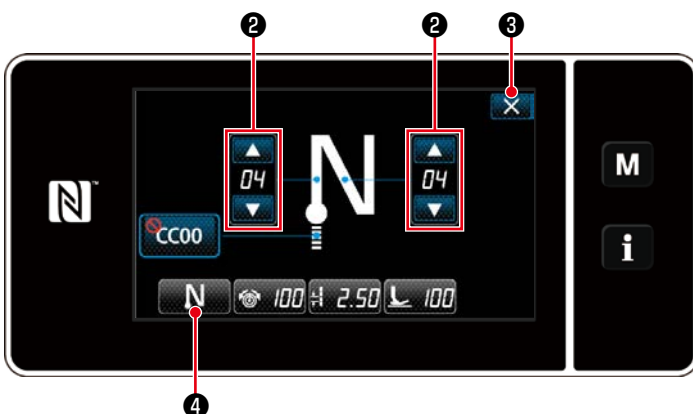

Change the numeric value with ② .

The value you have entered is confirmed by pressing ③ . Then, the sewing screen is displayed.

Press ④ to select the type of sewing.

<Sewing-end reverse feed stitching edit screen>

4-2-8. Teaching function

This is the function that enables entry of the number of stitches of a sewing pattern using the actual number of stitches sewn.

This function screen can be displayed from the sewing data edit screen.

* The teaching function can be used in the case the "constant-dimension sewing" or "polygonal-shape stitching" is selected.

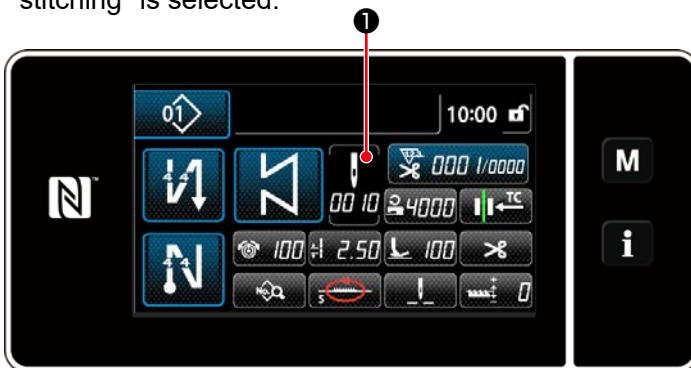

<Sewing screen (constant-dimension sewing)
(Maintenance personnel mode)>

Press **1** on the sewing data list screen.
Then, the number of stitches input screen is displayed.

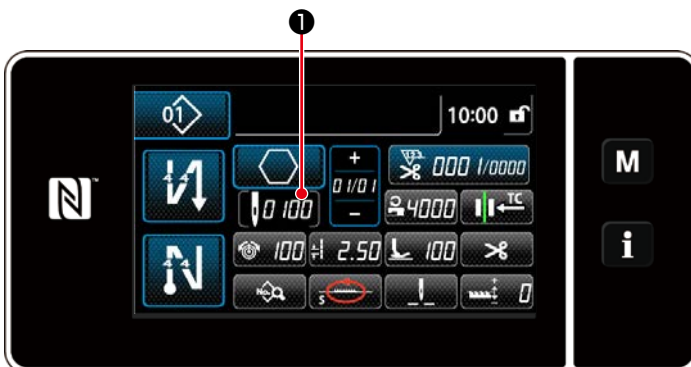

<Sewing screen (polygonal-shape stitching)
(Maintenance personnel mode)>

(1) How to set (constant-dimension sewing)

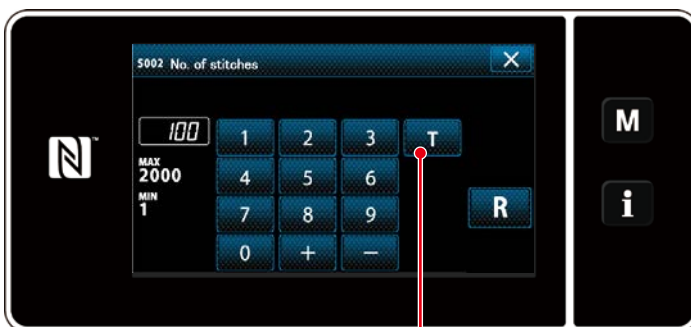

<Number of stitches input screen>

① Turning ON the teaching function

Press **T** **2** to turn ON the teaching function.

② Starting teaching

The input value is set to 0 (zero). Depress the pedal to start sewing. Count the number of stitches until the sewing machine stops.

③ Confirming the data entered under the teaching mode

Confirm the content of teaching by carrying out thread trimming.

Return the current screen to the sewing screen (maintenance personnel mode).

(2) How to set (polygonal-shape stitching)

① Turning ON the teaching function

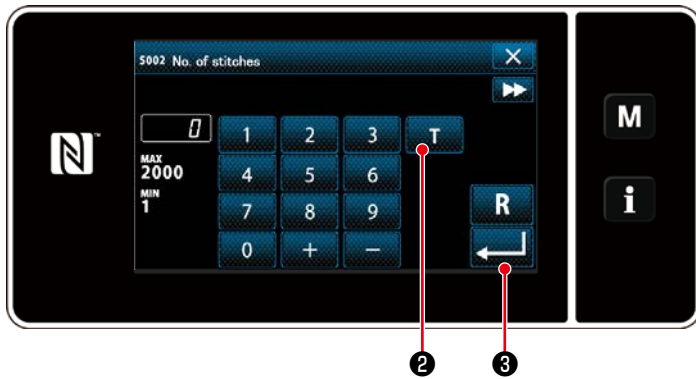

<Number of stitches input screen>

Press **T** ② to turn ON the teaching function.

② Start teaching, and confirm data on a step-by-step basis

The input value is set to 0 (zero). Depress the pedal to start sewing. Count the number of stitches until the sewing machine stops.

1. In the case of starting the teaching by operation on the operation panel

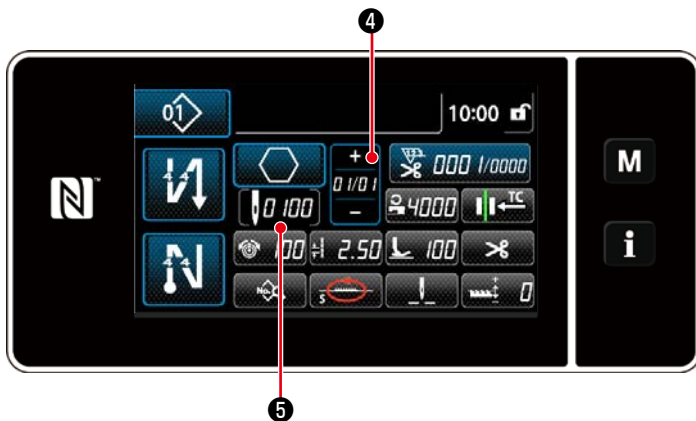

Carry out the step until its end is reached (the last stitch is sewn). Then, press **↩** ③ to confirm the teaching data.

Return the current screen to the sewing screen (maintenance personnel mode).

Press **+** ④ to confirm the teaching data

on the current step. Press **0 100** ⑤ to change the current screen to the number of stitches input screen for the next step.

If no further step to be registered is present, this operation will be disabled.

2. In the case of starting the teaching using the pedal

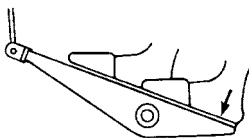

After the completion of sewing steps (the last stitch), depress the back part of pedal. Then, the data entered for the current step under the teaching mode is confirmed and the screen is changed to the teaching screen for the next step.

If no further step to be registered is present, this operation will be disabled.

4-2-9. One-touch utility changeover function

In the case the one-touch function is assigned to the custom switch, the pitch, sewing speed and feed dog height can be changed over by pressing the custom switch.

S003 Pitch	⇔	S062 One-touch type changeover of pitch
S004 Thread tension	⇔	S063 One-touch type thread tension
S005 Presser foot pressure	⇔	S064 One-touch type presser foot pressure
S047 Sewing speed	⇔	S061 One-touch type changeover of sewing speed
S050 Feed dog height	⇔	S065 One-touch type changeover of feed dog height
S048 Feed locus	⇔	S066 One-touch type changeover of feed locus

Refer to ["3-11. Custom switch" p. 27](#).

During the one-touch utility changeover, the target data display changes.



4-2-10. Registration of a new sewing pattern

A newly-created sewing pattern is registered by following the steps of procedure described below.

① Selecting the new-pattern creating function

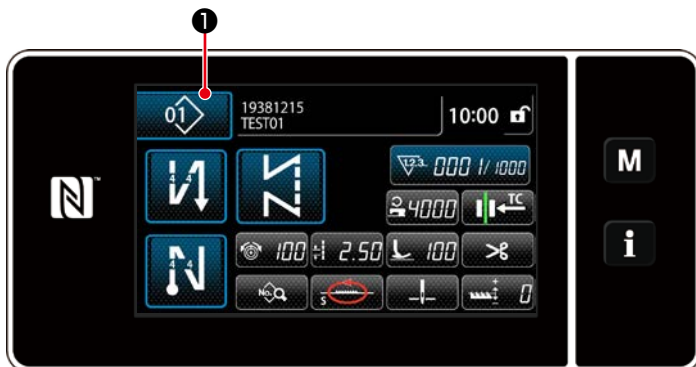

1. Press **01** **1** to display the sewing pattern management screen.

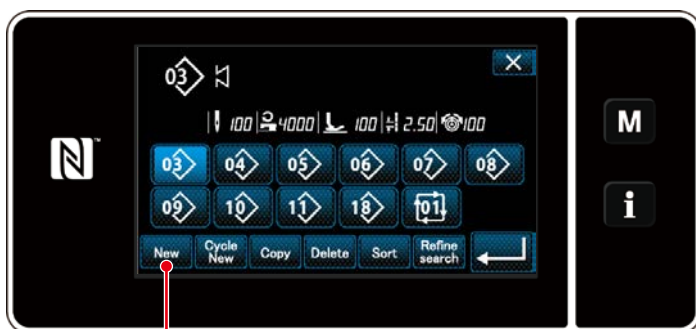

2. Press **New** **2**.

2
<Sewing pattern management screen>



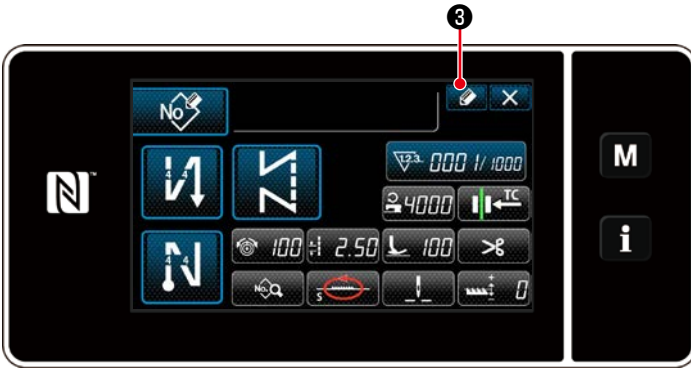

3. Select the desired sewing shape (free stitching, constant-dimension sewing, multi-layer stitching, polygonal shape stitching).

② Selecting the new sewing pattern number

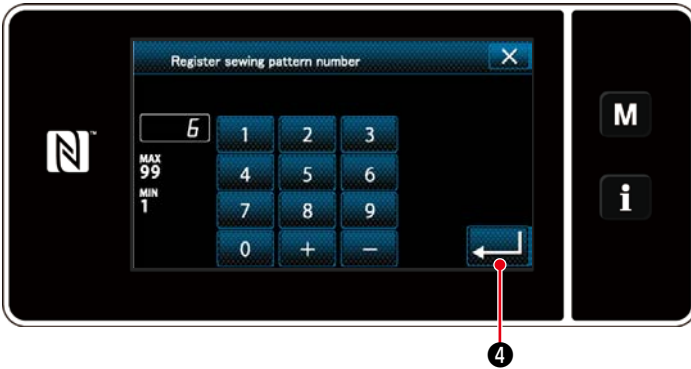

1. Press  ③ to display the sewing pattern No. registration.



2. Enter the pattern number to be registered using the numeric keypad.
3. Press  ④ to confirm the pattern number you have entered. The sewing pattern management screen is displayed.

③ Confirming the data on the created sewing pattern

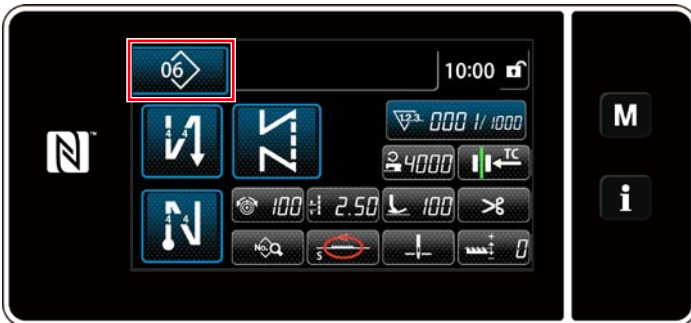

The newly created sewing pattern is displayed.

<Sewing screen>

4-2-11. Copying a pattern

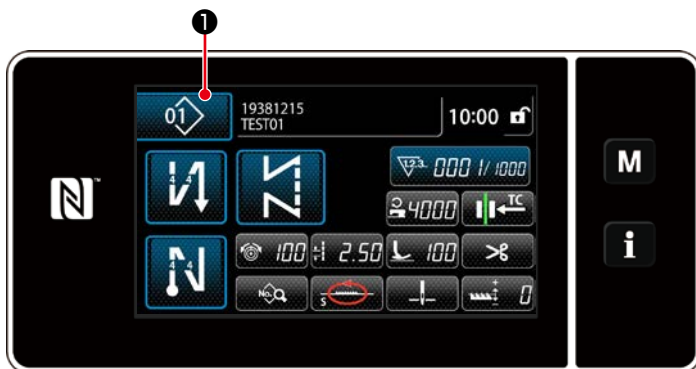

1. Press **01** **1** to display the sewing pattern management screen.

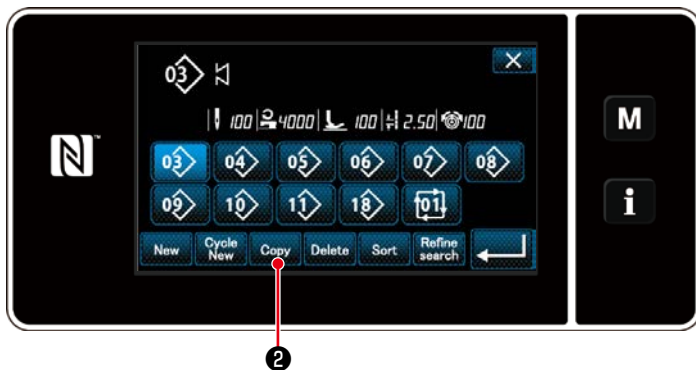

2. Press **Copy** **2**.

<Sewing pattern management screen>

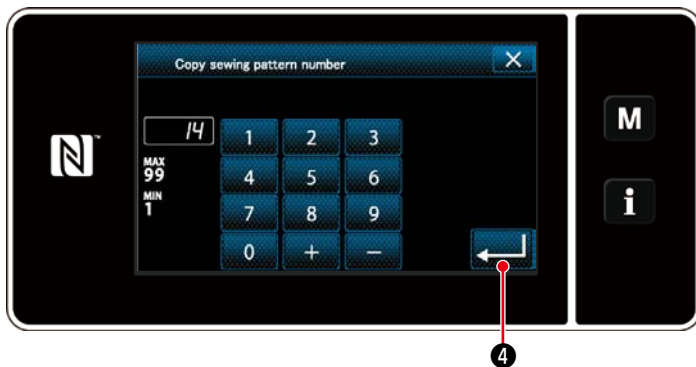

3. Input a copy pattern number with the numeric keypad.
 4. Press **↩** **4** to confirm the pattern number you have entered.



5. The newly created sewing pattern is displayed.

4-2-12. Narrow-down function

It is possible to select and display sewing pattern(s) which include target characters from the sewing patterns stored in memory by entering the target characters such as the product number, process or comment. This function can be used both under the operator mode and maintenance personnel mode.

① Selecting the new-pattern creating function

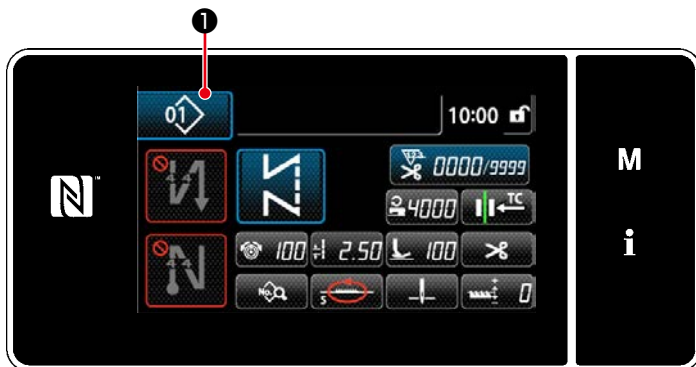

<Sewing screen (maintenance personnel mode)>

1. Press  ① to display the sewing pattern management screen.

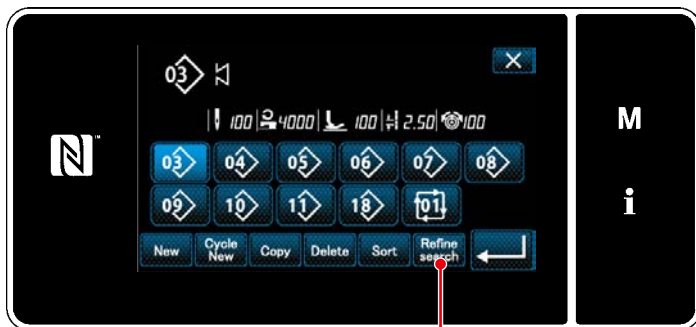



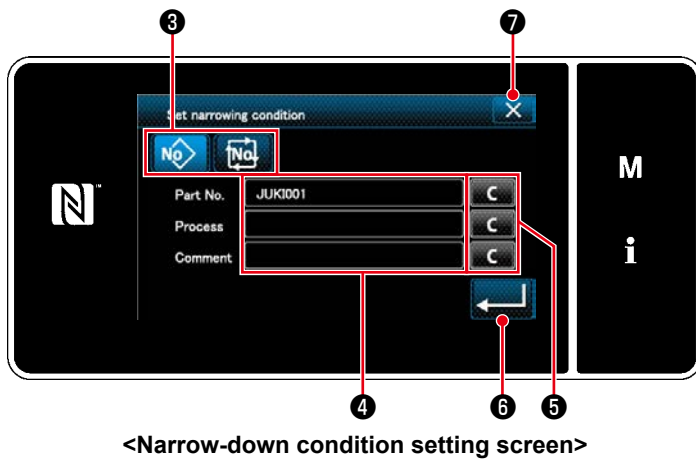

<Sewing pattern management screen>

2. Press  ②.

② Select the target pattern to be narrowed down



1. Select sewing patterns from which a desired pattern is narrowed down using button   ③ .
2. The character input screen is displayed by pressing ④ .
It is possible to enter a character(s) which is to be used for narrow-down operation with the character string button.
3. The entered characters are erased by pressing button  ⑤ .

4. The "sewing pattern number list screen" containing only the patterns which include the entered character(s) are displayed by pressing  ⑥ .
 5. Narrow-down operation is not carried out by pressing  ⑦ . Then, the "sewing pattern number list screen" is displayed.
- * In the case characters are entered for two or more items on the narrow-down condition setting screen, only the patterns which satisfy all the entered conditions are displayed. For cycle sewing patterns, a comment is only used as the narrow-down condition.

4-3. Counter function

This function counts sewing in the predetermined unit and gives a visible alarm on the screen when the preset value is reached.

4-3-1. Displaying the sewing screen under the counter display mode



Three different types of the counter are available, i.e., the bobbin thread counter, the sewing counter and the pitch time counter.

4-3-2. Types of the counter

	<p>Bobbin thread counter</p> <p>The bobbin thread counter adds one to its current value every time the sewing machine sews 10 stitches.</p> <p>When the preset value is reached, the count-completion screen is displayed.</p> <p>* Refer to "4-3-4. How to reset the count-completion state" p. 62.</p>
	<p>Sewing counter</p> <p>The sewing counter adds one to its current value every time one stitch shape is sewn.</p> <p>When the preset value is reached, the count-completion screen is displayed.</p> <p>* Refer to "4-3-4. How to reset the count-completion state" p. 62.</p>
	<p>Pitch time counter</p> <p>The pitch time counter adds one to its current value every time one stitch shape is sewn.</p> <p>The target value counter adds one to its current value on the preset pitch-by-pitch basis.</p> <p>* Refer to "4-3-4. How to reset the count-completion state" p. 62.</p>

4-3-3. How to set the counter

① Selecting the counter setting

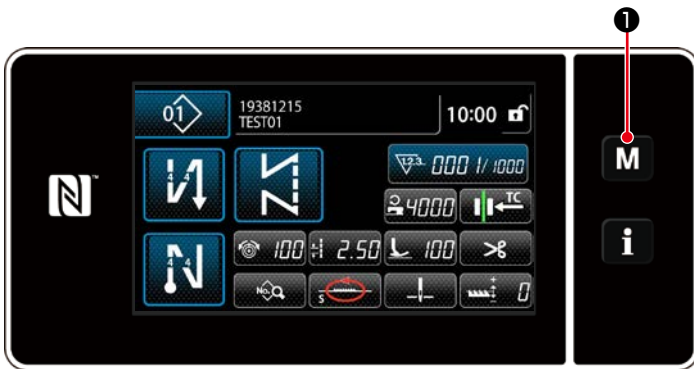

1. Display the mode screen by pressing



2. Select the "Counter setting".

<Mode screen>

② Setting the type of counter, current value of counter and preset value for counter

The sewing counter and the bobbin counter should be set following the same procedure.

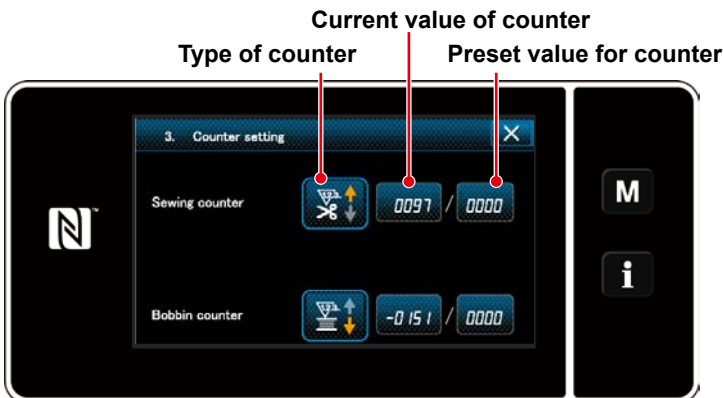

<Counter setting screen>

1. The counter setting screen is displayed to enable setting.
2. Press the button of the desired item. Then, the change screen corresponding to that item is displayed.



<Counter type screen>

1. Select the desired type of counter.
2. Press  ② to confirm the type of counter you have selected.

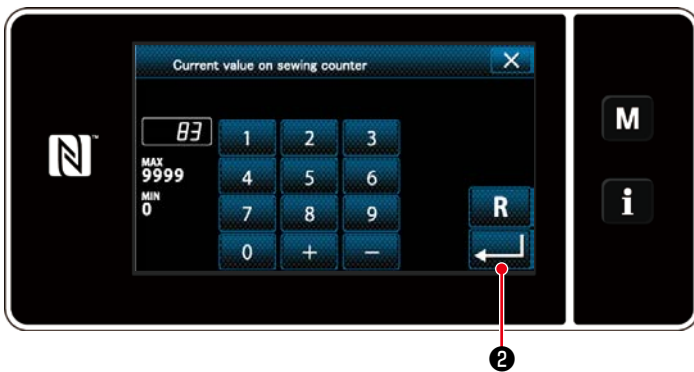





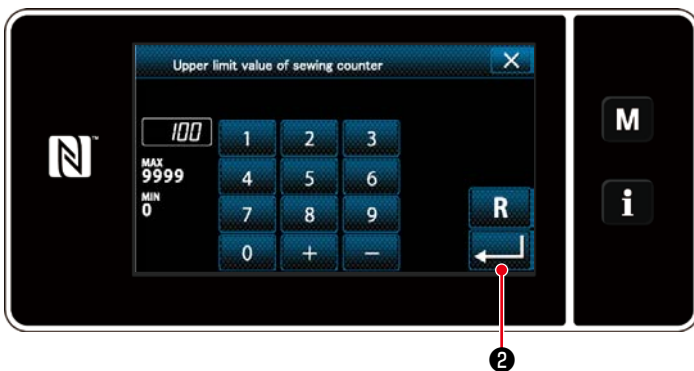

<Current counter value screen>

1. Select the current counter value.
2. Enter with the numeric keypad.
3. Press  ② to confirm the type of counter you have selected.



<Counter set value screen>

1. Select the counter set value.
2. Enter with the numeric keypad.
3. Press  ② to confirm the type of counter you have selected.

Bobbin thread counter	
	<p>UP counter (adding method): The bobbin thread counter adds one to its current value every time the sewing machine sews 10 stitches. When the current value reaches the preset value, the count-completion screen is displayed.</p>
	<p>DOWN counter (subtracting method): The bobbin thread counter subtracts one from its current value every time the sewing machine sews 10 stitches. When the current value becomes 0 (zero), the count-completion screen is displayed.</p>
—	<p>Disuse of counter: The bobbin thread counter counts nothing even when the sewing machine performs sewing. The count-completion screen is, therefore, not displayed.</p>
Sewing counter	
	<p>UP counter (adding method): The counter adds one to its current value every time the sewing machine sews one stitch shape. When the current value reaches the preset value, the count-completion screen is displayed.</p>
	<p>DOWN counter (subtracting method): The counter subtracts one from its current value every time the sewing machine sews one stitch shape. When the current value becomes 0 (zero), the count-completion screen is displayed.</p>
—	<p>Disuse of counter: The sewing counter counts nothing even when the sewing machine performs sewing. The count-completion screen is, therefore, not displayed.</p>
Pitch time counter	
	<p>UP counter (adding method): The counter adds one to its current value every time the sewing machine sews one stitch shape.</p>
	<p>DOWN counter (subtracting method): The counter subtracts one from its current value every time the sewing machine sews one stitch shape.</p>
—	<p>Disuse of counter: The sewing counter counts nothing even when the sewing machine performs sewing. The count-completion screen is, therefore, not displayed.</p>

③ Confirming the data entered



<Mode screen>

Confirm the data on counter setting items you have entered. Then, press  ③ to return the screen to the mode screen.

When you press  ③ again, the screen is returned to the sewing screen.



<Sewing screen (counter)>

The data on the counter function entered is displayed.

4-3-4. How to reset the count-completion state

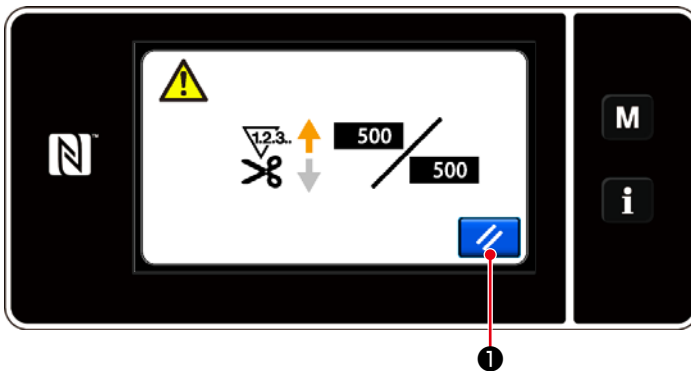

<Count-completion screen>

When the predetermined conditions are satisfied during sewing, the count-completion screen is displayed.

The counter is reset by pressing  ①.

Then, the mode is returned to the sewing mode. In this mode, the counter starts counting again.

4-4. Simplified chart of panel displays

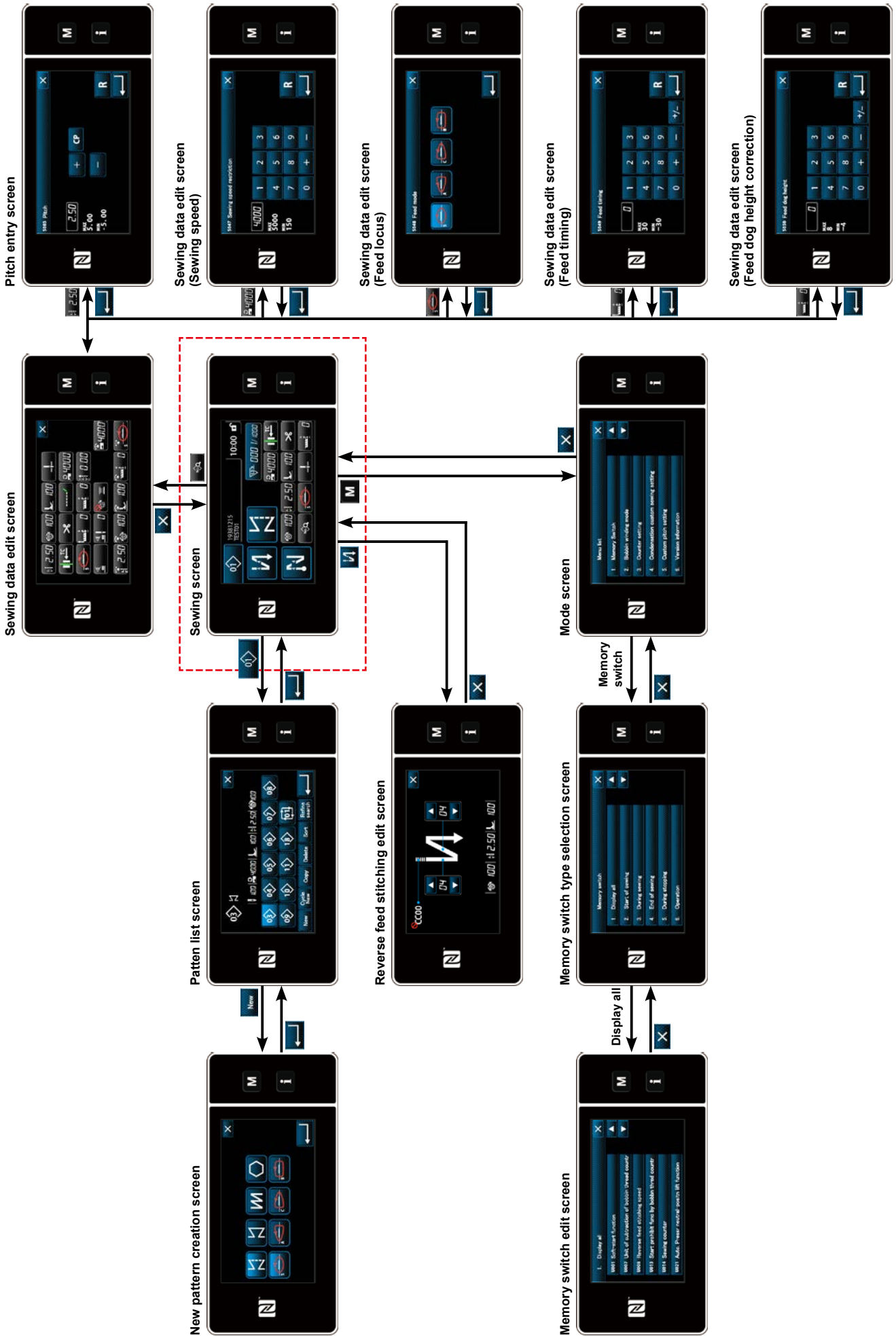

4-5. List of memory switch data

No.	Item	Setting range	Unit
U001	Soft-start function The initial value differs with the machine head. (0: OFF)	0 to 9	Stitch
U002	Material edge sensor function 0:Without the material edge detection function / 1:Sewing machine stops after sewing the preset number of stitches (U004) following the detection of material edge	0 to 1	—
U003	Thread trimming function activated by material edge sensor 0:Without the automatic thread trimming function after detection of material edge / 1:Sewing machine stops and simultaneously carries out automatic thread trimming after sewing the preset number of stitches (U004) following the detection of material edge	0 to 1	—
U004	Number of stitches for material edge sensor Number of stitches to be sewn after the detection of material edge until the sewing machine stops.	0 to 19	Stitch
U007	Bobbin thread count-down unit 0: 10 stitches / 1: 15 stitches / 2: 20 stitches	0 to 2	—
U008	Reverse feed stitching speed The initial value differs with the machine head. The number of revolutions set with this memory switch is given precedence even if it is lower than the lowest speed by pedal.	150 to 3000	sti/min
U013	Bobbin thread count stop function 0: Sewing machine start prohibition function is disabled even when the counter completes counting (negative value). 1: When the counter completes counting, the sewing machine start after thread trimming is prohibited. 2: When the counter completes counting, the sewing machine temporarily stops and the start of sewing machine after thread trimming is prohibited. * Note that the prohibition function is disabled in the case the initial value of counter is 0 (zero).	0 to 2	—
U014	Sewing count function 1: Automatic sewing counter / 2: Sewing counter switch input	1 to 2	—
U021	Presser foot lift when the pedal is in its neutral position 0: Disabled / 1: Enabled	0 to 1	—
U025	Operation after manual turning (thread trimming) This memory switch is used for setting the thread trimmer operation after the sewing machine has moved from its upper/lower stop position by manual turning of handwheel. 0: Permitted / 1: Prohibited	0 to 1	—
U030	Middle-of-sewing reverse feed stitching function Midpoint-of-sewing reverse feed stitching function is set. 0: Without the midpoint-of-sewing reverse feed stitching function / 1: With the midpoint-of-sewing reverse feed stitching function	0 to 1	—
U031	Number of stitches of middle-of-sewing reverse feed stitching Number of midpoint-of-sewing reverse feed stitches is set.	1 to 19	Stitch
U032	Condition of enabling middle-of-sewing reverse feed stitching while sewing machine is at rest Midpoint-of-sewing reverse feed stitching function enable condition 0: Disabled when the swing machine is at rest / 1: Enabled when the sewing machine is at rest	0 to 1	—

No.	Item	Setting range	Unit
U033	Thread trimming activated by middle-of-sewing reverse feed stitching Thread trimming function after the completion of midpoint-of-sewing reverse feed stitching is set. 0: Without automatic thread trimming function / 1: With automatic thread trimming function	0 to 1	—
U035	Minimum speed of the pedal The maximum number of revolutions during thread trimming differs with the machine head.	150 to Max. of thread trimming	sti/min
U036	Speed during thread trimming The maximum number of revolutions during thread trimming differs with the machine head.	130 to Max. of thread trimming	sti/min
U037	Speed during soft start The maximum number of revolutions during soft start differs with the machine head. The number of revolutions set with this memory switch is given precedence even if it is lower than the lowest speed by pedal.	100 to Max.	sti/min
U038	Speed during one-shot stitching The maximum number of revolutions during soft start differs with the machine head.	100 to Max.	sti/min
U039	Start position of rotation Set start position from neutral pedal position. (Pedal Stroke)	10 to 5000	—
U040	Start position of acceleration Set accelerating position from neutral pedal position. (Pedal Stroke)	10 to 1000	—
U041	Start position of lifting of presser foot Set work clamp lift position from neutral pedal position. (Pedal Stroke)	-500 to -10	—
U042	Start position of lowering of presser foot Set work clamp fall position from neutral pedal position. (Pedal Stroke)	10 to 500	—
U043	Start position of thread trimming Set thread trimming starting position from neutral pedal position. (Pedal Stroke)	-1000 to -100	—
U044	Position that maximum sewing speed is reached Set maximum speed reaching position from neutral pedal position. (Pedal Stroke)	10 to 15000	—
U045	Pedal neutral-position correction value Set neutral position of pedal sensor.	-150 to 150	—
U047	Presser-foot lift finishing position The position to which the presser foot goes up when the back part of the pedal is depressed to its first step. (1st-step spring position)	-1000 to -100	—
U049	Presser foot lowering time The initial value differs with the machine head.	0 to 500	ms
U051	Correction of turning-ON of reverse feed stitching (at start)	-50 to 50	Degree
U052	Correction of turning-OFF of reverse feed stitching (at start)	-50 to 50	Degree
U053	Correction of turning-OFF of reverse feed stitching (at end)	-50 to 50	Degree
U055	Presser foot lift after thread trimming The initial value differs with the machine head. 0: No lift / 1: Lift	0 to 1	—

No.	Item	Setting range	Unit
U056	Reverse-rotation needle-up after thread trimming The initial value differs with the machine head. 0: Reverse-rotation needle-up is not performed / 1: Reverse-rotation needle-up is performed	0 to 1	—
U057	Function for lowering the feed dog during thread trimming The presser foot height is fixed at 0 (zero) during thread trimming. 0: OFF / 1: ON	0 to 1	—
U059	Selection of reverse feed stitching (at start) operation 0: Manual / 1: Automatic	0 to 1	—
U060	Stop after reverse feed stitching (at start) The stop function stops the sewing machine temporarily regardless of the operating status of the pedal. 0: OFF / 1: ON	0 to 1	—
U064	Sewing speed at the start of reverse feed stitching (at end)	150 to 1000	sti/min
U068	Presser foot lifting operation changeover The presser foot lifting operation when depressing the back part of pedal is changed over. 0: 2-step operation / 1: Manual operation depending on the pedal stroke when the back part of pedal is depressed	0 to 1	—
U069	Presser-foot 1st step lifting height Maximum height of presser foot at the 1st step of its lifting operation when the back part of pedal is depressed.	0.1 to 8.5	mm
U070	Presser-foot 2nd step lifting height Maximum height of presser foot at the 2nd step of its lifting operation when the back part of pedal is depressed. (When the back part of pedal is depressed until the thread trimming position is reached after the presser foot comes down after thread trimming.)	8.5 to 13.5	mm
U073	Re-try function Retry is used when the needle fails to fully penetrate the material. 0: Without retry / 1: Normally retry	0 to 1	—
U087	Pedal acceleration characteristic 0: Standard / -1 to -10: Low-frequency low acceleration / 1 to 10: Low-frequency high acceleration	-10 to 10	—
U090	Initial-start upper-position stopping function 0: The sewing machine stops with its needle up after checking the panel. 1: The machine automatically stops with its needle up.	0 to 1	—
U092	Speed reducing function for reverse feed stitching at beginning of sewing Speed reduction function after the completion of start reverse feed stitching is set. 0: Speed is not reduced. / 1: Speed is reduced	0 to 1	—
U093	Needle up/down correction switch adding function Needle up/down correction switch operation after the power-ON or after thread trimming is set. 0: Normal (only the needle-up/down operation) / 1: One-stitch correction is performed only in the aforementioned case (needle-up stop → Needle-up stop)	0 to 1	—
U096	Maximum sewing speed The initial value differs with the machine head.	150 to Max.	sti/min

No.	Item	Setting range	Unit
U120	Main shaft reference angle correction The main shaft reference signal angle (0 degree) is corrected with the value set using this memory switch.	-60 to 60	Degree
U121	Upper stop position angle correction The position at which the sewing machine stops with its needle up is corrected.	-15 to 15	Degree
U122	Lower stop position angle correction The position at which the sewing machine stops with its needle down is corrected.	-15 to 15	Degree
U182	Sewing counter stopping function 0: The sewing machine does not stop even when the sewing counter completes counting. 1: When the counter completes counting, the sewing machine start after thread trimming is prohibited. * Note that the prohibition function is disabled in the case the initial value of counter is 0 (zero).	0 to 1	—
U183	Number of times of thread trimming for sewing counter	1 to 20	—
U201	Thread tension correction (bobbin thread remaining amount) Remaining amount of bobbin thread to start correction This memory switch is used to set the remaining amount of bobbin thread to start correction of the needle thread tension.	0 to 100	%
U202	Thread tension correction (bobbin thread remaining amount) Final correction amount This memory switch is used to set the needle thread tension correction amount when the remaining amount of bobbin thread is minimized.	50 to 200	%
U280	Number of condensation stitches at the end of sewing before shorter-thread remaining type thread trimmer operates When the shorter-thread remaining function is placed in ON, this memory switch is used for setting the number of condensation stitches to be sewn before thread trimming.	1 to 9	Stitch
U281	Pitch of condensation stitches at the sewing end before shorter-thread remaining type thread trimmer operates When the shorter-thread remaining function is placed in ON, this memory switch is used for setting the stitch pitch of condensation stitches to be sewn before thread trimming.	0 to 2.5	0.05 mm
U286	Sewing speed during thread presser operation This memory switch is used for setting the speed to be employed when the thread presser operates.	100 to 3000	sti/min
U288	Thread presser ON angle This memory switch is used for setting the angle at which the thread presser is turned ON at the start of sewing.	180 to 290	Degree
U289	Thread presser OFF angle This memory switch is used for setting the angle at which the thread presser is turned OFF at the start of sewing.	210 to 359	Degree
U290	AK operating time when the thread presser operates The time to turn ON the AK device that operates when the thread presser operates.	0 to 50	ms

No.	Item	Setting range	Unit
U292	Soft-start resetting angel when the thread presser operates This memory switch is used for setting the angle at which the soft-start is reset. * The setting is enabled when the thread presser operates.	180 to 900	Degree
U293	Sewing speed resetting angle when the thread presser operates This memory switch is used for setting the angle at which the sewing speed employed when the thread presser operates is reset. * The setting is enabled when the thread presser operates.	0 to 720	Degree
U294	Thread-presser initial suction time	4 to 10	ms
U326	Feed dog travel to 0 position when lifting the presser foot The feed dog height is set to 0 (zero) when lifting the presser foot. The material on the sewing machine can be handled with ease when this function is used. 0: OFF / 1: ON	0 to 1	—
U400	Panel operation mode This memory switch is used for specifying the mode of the sewing screen that is displayed at the time of startup. 0: Maintenance personnel mode / 1: Operator mode	0 to 1	—
U401	Input unit of pitch 0: Pitch (mm) / 1: Number of stitches per inch 2: Number of stitches in 3 cm	0 to 2	—
U402	Automatic lock time The sewing machine is automatically locked in the case the operation panel is not operated for a predetermined period of time.	0 to 300	Second
U403	Auto-OFF of back light Back light of the panel is automatically turned off in the case the operation panel is not operated for a certain period of time.	0 to 20	
U404	Selection of part number and process / comment display This memory switch is used for specifying either the part number/process is displayed or comment is displayed on the sewing screen. 0: Part number/process / 1: Comment	0 to 1	—
U406	Language selection 0: Not yet selected / 1: Japanese / 2: English / 3: Chinese	0 to 3	—
U407	Operating sound of panel 0: OFF / 1: ON	0 to 1	—

4-6. List of errors

Error code	Description of error	Cause	Item to be checked
E000	Execution of data initialization (This is not an error.)	<ul style="list-style-type: none"> The existing control box has been removed and a new one is mounted. In the case the initialization operation is executed. 	This is not a failure.
E007	Motor overload	<ul style="list-style-type: none"> In the case the machine head is locked. In the case of sewing extra-heavy weight material that exceeds the guaranteed material thickness. In the case the motor fails to rotate. In the case of the motor or driver failure. 	<ul style="list-style-type: none"> Check whether the pulley is entangled with thread. Check whether the motor output connector (4P) has loosened. Check whether the motor can be turned smoothly by hand.
E009	Overtime of solenoid energization	<ul style="list-style-type: none"> In the case the length of solenoid energizing time has exceeded the assumed one. 	
E011	Media is not inserted	<ul style="list-style-type: none"> In the case no media is inserted. 	<ul style="list-style-type: none"> Turn the power OFF and check for a media.
E012	Read error	<ul style="list-style-type: none"> In the case data stored on the media cannot be read. 	<ul style="list-style-type: none"> Turn the power OFF and check for a media.
E013	Write error	<ul style="list-style-type: none"> In the case data cannot be written on the media. 	<ul style="list-style-type: none"> Turn the power OFF and check for a media.
E014	Write protect	<ul style="list-style-type: none"> In the case the media is placed in the write-prohibition state. 	<ul style="list-style-type: none"> Turn the power OFF and check for a media.
E015	Format error	<ul style="list-style-type: none"> In the case formatting of the media cannot be carried out. 	<ul style="list-style-type: none"> Turn the power OFF and check for a media.
E016	External media over-capacity	<ul style="list-style-type: none"> In the case the capacity of media is not enough. 	<ul style="list-style-type: none"> Turn the power OFF and check for a media.
E019	File size over	<ul style="list-style-type: none"> In the case of attempting to read the custom pitch data or condensation custom data which exceeds the maximum permissible data size into the memory of sewing machine from the USB thumb drive. 	<ul style="list-style-type: none"> Turn the power OFF and check the USB thumb drive.
E022	File undetected	<ul style="list-style-type: none"> In the case of attempting to read a file which is not stored in the USB thumb drive into the operation panel. 	
E032	File compatibility error	<ul style="list-style-type: none"> In the case the file is not compatible. 	<ul style="list-style-type: none"> Turn the power OFF and check for a media.
E071	Slip-off of the motor connector	<ul style="list-style-type: none"> In the case the motor connector has slipped off. 	<ul style="list-style-type: none"> Check for looseness and slip-off of the motor output connector.
E072	Motor overload when the thread trimmer operates	<ul style="list-style-type: none"> Same as E007. 	<ul style="list-style-type: none"> Same as E007.
E079	Overload operation error	<ul style="list-style-type: none"> Load applied to the main shaft motor is excessively large. 	
E081	Feed driving motor lock	<ul style="list-style-type: none"> In the case the feed driving motor is locked. 	<ul style="list-style-type: none"> Check whether the feed driving motor operates smoothly.
E204	USB insertion	<ul style="list-style-type: none"> In the case the sewing machine is started up without removing the USB thumb drive. 	<ul style="list-style-type: none"> Remove the USB thumb drive.

Error code	Description of error	Cause	Item to be checked
E205	ISS buffer capacity runout warning	<ul style="list-style-type: none"> • Buffer for storing ISS data will soon be filled to its capacity. If the buffer is used continuously, the stored data will be automatically erased on FIFO basis. 	<ul style="list-style-type: none"> • Output the ISS data.
E220	Warning against shortage of grease	<ul style="list-style-type: none"> • When the predetermined number of stitches is reached. 	<ul style="list-style-type: none"> • Add grease to the specified points of sewing machine and reset the error.
E221	Grease-shortage error	<ul style="list-style-type: none"> • In the case the sewing machine cannot continue sewing since the predetermined number of stitches is reached. 	<ul style="list-style-type: none"> • Add grease to the specified points of sewing machine and reset the error.
E302	Head-tilt detection error (When the safety switch operates)	<ul style="list-style-type: none"> • In the case the Tilt detection switch is turned ON when the power to the sewing machine remains ON. 	<ul style="list-style-type: none"> • Check whether the machine head is tilted before turning OFF the power switch (The sewing machine operation is prohibited for the sake of safety.)
E303	Meniscus sensor error	<ul style="list-style-type: none"> • In the case the meniscus sensor signal cannot be detected. 	<ul style="list-style-type: none"> • Check for a break in the motor encoder connector.
E402	Deletion disabled error	<ul style="list-style-type: none"> • In the case of attempting to delete the pattern which is used in a cycle pattern. • In the case of attempting to delete the custom pitch or condensation custom which is used in a pattern. 	
E407	Wrong password	<ul style="list-style-type: none"> • In the case the password entered is wrong. 	
E408	Shortage of number of password characters	<ul style="list-style-type: none"> • In the case the number of password characters entered is not enough. 	
E411	Polygonal stitching pattern registration disabled error	<ul style="list-style-type: none"> • In the case of attempting to create eleven or more polygonal stitching patterns. 	
E412	Custom pitch unregistered error	<ul style="list-style-type: none"> • In the case the custom pitch number is faulty. 	
E413	Condensation custom unregistered error	<ul style="list-style-type: none"> • In the case the condensation custom number is faulty. 	
E499	Simplified program fault		
E704	Data failure (system-version mismatch)	<ul style="list-style-type: none"> • In the case the system version does not match the machine head setting. 	<ul style="list-style-type: none"> • Re-write the system version to the applicable one.
E731	Motor hole sensor fault	<ul style="list-style-type: none"> • In the case the motor signal is not input properly. 	<ul style="list-style-type: none"> • Check whether the motor signal connector has loosened or slipped off. • Check whether the motor signal cord has broken by being caught under the machine head. • Check whether the insertion direction of the motor encoder connector is correct.
E733	Reverse rotation of motor	<ul style="list-style-type: none"> • When the motor runs at a speed of 500 sti/min. or more, the motor runs in the reverse direction of the indicated direction of rotation. 	<ul style="list-style-type: none"> • Check whether the main shaft motor encoder wire connection is correct. • Check whether the main shaft motor wire connection for power is correct.

Error code	Description of error	Cause	Item to be checked
E750	Sewing machine stops	<ul style="list-style-type: none"> In the case the optional-input safety switch is pressed. 	
E811	Over-voltage	<ul style="list-style-type: none"> In the case a voltage that is equal to or more than the guaranteed voltage is input. In the case a voltage of 200 V is applied though the voltage is set to 100 V. In the case a voltage of 220 V is input to the box of "JA: 120 V". In the case a voltage of 400 V is applied to the box of "CE: 230 V". 	<ul style="list-style-type: none"> Check whether the supply voltage of "rated supply voltage $\pm 10\%$ or more" is applied. Check whether the 100 V/200 V changeover connector is set correctly. In the above-described cases, the power PCB has broken.
E813	Low voltage		
E815	Regenerative resistor is not connected	<ul style="list-style-type: none"> In the case the regenerative resistor is not connected. 	<ul style="list-style-type: none"> Check whether the regenerative resistor is connected to the regenerative resistor connector (CN11).
E900	Main shaft motor IPM overcurrent protection	<ul style="list-style-type: none"> Maloperation of the main shaft motor. 	
E901	Main shaft motor IPM overload		
E903	85-V power supply fault	<ul style="list-style-type: none"> In the case the 85-V voltage is not properly output. 	<ul style="list-style-type: none"> Check whether the stepping motor is faulty. Check the F2 fuse.
E904	24-V power supply fault	<ul style="list-style-type: none"> In the case the 24-V voltage is not properly output. 	
E910	The presser motor origin retrieval error	<ul style="list-style-type: none"> In the case the presser motor has failed to return to its origin. 	<ul style="list-style-type: none"> Check whether the presser setting is correct (memory switch No. 23). Check whether the presser motor origin has been correctly adjusted.
E912	Main shaft motor speed detection error		
E915	Failure of communication with operation panel	<ul style="list-style-type: none"> In the case communication with the operation panel cannot be carried out. 	
E918	Main shaft temperature error	<ul style="list-style-type: none"> In the case the temperature of the CTL PCB is excessively high. 	
E922	Main shaft control failure	<ul style="list-style-type: none"> In the case the main shaft motor is out of control. 	
E924	Motor driver fault	<ul style="list-style-type: none"> In the case the motor driver has broken. 	
E946	Machine-head EEPROM write error	<ul style="list-style-type: none"> In the case the machine head PCB is not correctly connected. 	<ul style="list-style-type: none"> Check whether CN32 has loosened or come off.
E955	Electric current sensor error	<ul style="list-style-type: none"> Main motor shaft failure. Electric current sensor failure. 	<ul style="list-style-type: none"> Check whether the main shaft motor has short-circuited.
E961	Pitch motor deviation error	<ul style="list-style-type: none"> In the case the pitch motor fails to operate because of an excessive load. 	<ul style="list-style-type: none"> Check whether the pitch motor runs smoothly.
E962	Presser motor deviation error	<ul style="list-style-type: none"> In the case the presser fails to operate because of an excessive load. 	<ul style="list-style-type: none"> Check whether the presser motor runs smoothly.
E963	IPM temperature error	<ul style="list-style-type: none"> In the case the temperature of the CTL PCB is excessively high. 	

Error code	Description of error	Cause	Item to be checked
E965	Pitch motor temperature error	<ul style="list-style-type: none"> • In the case the pitch motor is applied with an excessive load. 	<ul style="list-style-type: none"> • Check whether the pitch motor runs smoothly.
E966	Feed driving motor temperature error	<ul style="list-style-type: none"> • In the case the feed driving motor is applied with an excessive load. 	<ul style="list-style-type: none"> • Check whether the feed driving motor runs smoothly.
E971	Pitch motor IPM overcurrent protection	<ul style="list-style-type: none"> • Pitch motor maloperation. 	
E972	Pitch motor overload	<ul style="list-style-type: none"> • In the case the pitch motor is applied with an excessive load. 	<ul style="list-style-type: none"> • Check whether the pitch motor runs smoothly.
E973	Feed driving motor IPM overcurrent protection	<ul style="list-style-type: none"> • Feed driving motor maloperation. 	
E974	Feed driving motor overload	<ul style="list-style-type: none"> • In the case the feed driving motor is applied with an excessive load. 	<ul style="list-style-type: none"> • Check whether the feed driving motor runs smoothly.
E975	Presser motor IPM over-current protection	<ul style="list-style-type: none"> • Presser motor maloperation. 	
E976	Presser motor overload	<ul style="list-style-type: none"> • In the case the presser motor is applied with an excessive load. 	<ul style="list-style-type: none"> • Check whether the presser motor runs smoothly.
E977	CPU fault	<ul style="list-style-type: none"> • In the case of a program fault. 	
E978	Network communication fault	<ul style="list-style-type: none"> • In the case the data received from the network is damaged. 	
E985	Return-to-origin error of pitch motor or feed driving motor	<ul style="list-style-type: none"> • In the case the pitch motor has failed to return to its origin. • In the case the feed driving motor has failed to return to its origin. 	<ul style="list-style-type: none"> • Check whether the origin of the pitch motor has been adjusted properly. • Check whether the origin of the feed driving motor has been adjusted properly.

4-7. Memory switch data

The memory switch data is the sewing machine operation data which commonly affects all sewing patterns and cycle patterns.

① Selecting the category of the memory switch data



<Sewing screen>

1. Press **M** ① on the sewing screen to display the "mode screen".

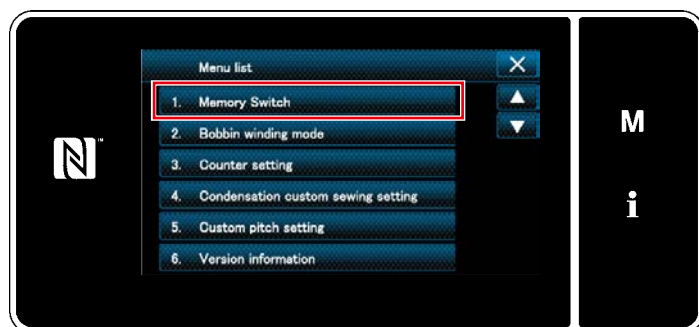

<Mode screen>

2. Select the "1. Memory switch".
The "memory switch type selection screen" is displayed.



<Memory switch type selection screen>

3. Select the "1. Display all".
The "memory switch edit screen" is displayed.
* In the case any item other than "1. Display all" is selected, only the memory switch which corresponds to the selected item is displayed on the memory switch edit screen.

② Setting the memory switch

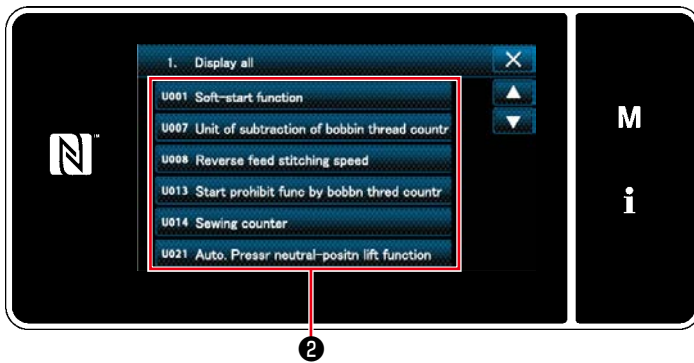

<Memory switch edit screen>

Select an item to edit from the memory switch list. Press button ② .

③ Confirming the data entered

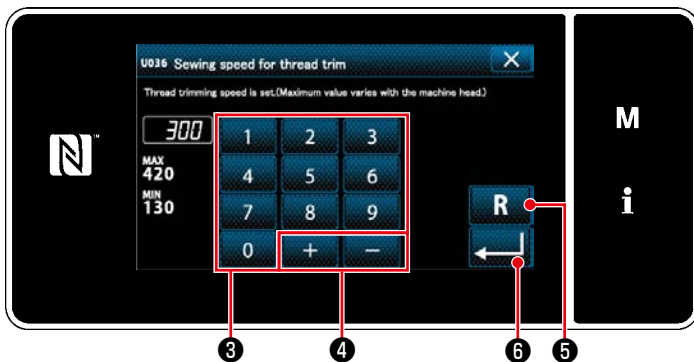

<Input screen>

1. Enter a set value with numeric keypad ③ and **+** **-** ④ .
2. Keep **R** ⑤ held pressed for one second to return the set value to the initial value.
3. Press **↵** ⑥ to confirm the setting. The "memory switch edit screen" is displayed.

5. MAIN NEW FUNCTIONS

As a result of computerization of the feed mechanism, various adjustments can be carried out. Refer to "4-2. Sewing patterns" p. 35 for details.



Due to computerization of the feed mechanism, the machine generates noise that is specific to the stepping motor when it runs at a low speed. This noise is not a sign of fault.

5-1. Shorter-thread remaining thread trimming

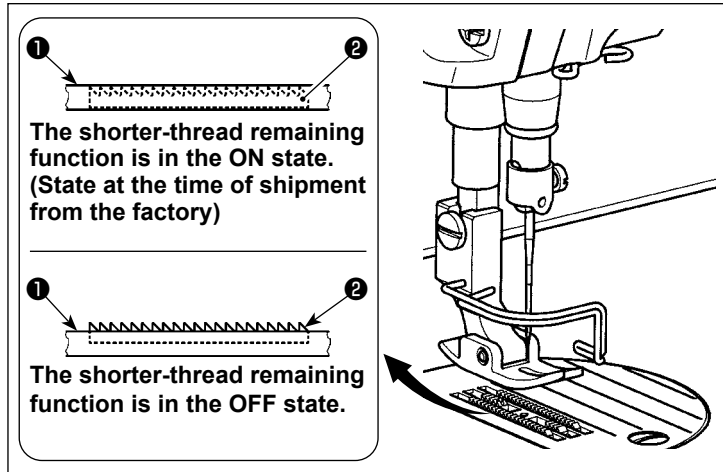

The length of needle thread remaining on the material after thread trimming is reduced by operating the thread trimmer with feed dog ❶ lowered.

In addition, since feed dog ❶ does not protrude from throat plate ❷, the material can be placed/removed on/from the sewing machine with ease.

* The setting of "Lowering/Not lowering the feed dog during thread trimming" can be changed over with "Memory switch U057".

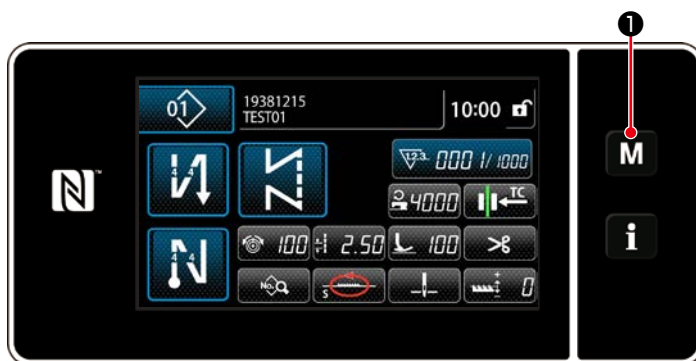

[How to set the feed dog]

1) Display the mode screen by pressing

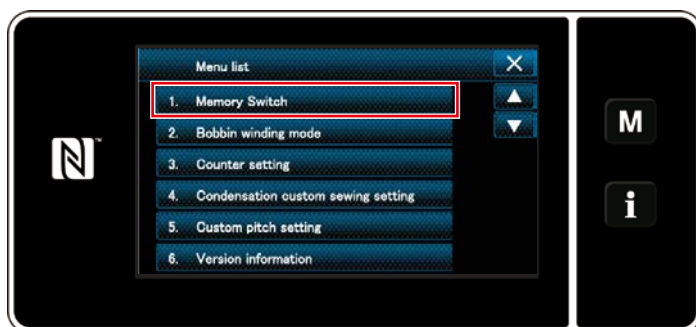

2) Select the "1. Memory switch".

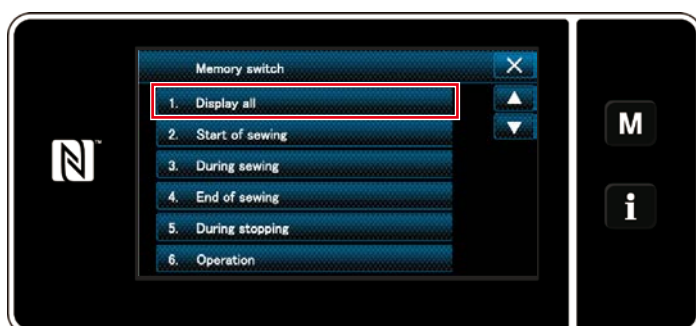

3) Select the "1. Display all".



4) Select the "U057 Function for lowering the feed dog during thread trimming".

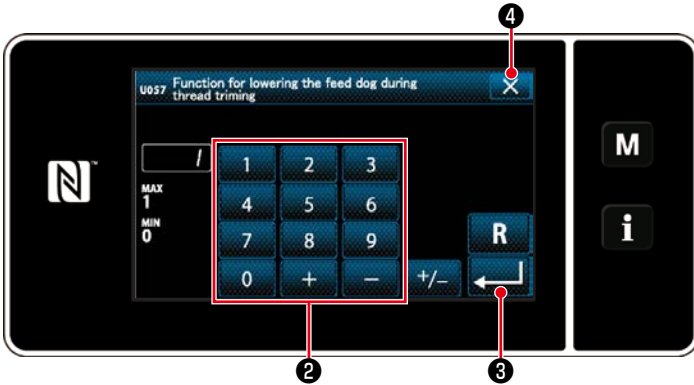

5) Select the feed dog status during thread trimming (0 : Feed dog UP, 1 : Feed dog DOWN) by pressing ten keys 2.

6) Confirm your entry by pressing  3.

7) Display the sewing screen by pressing  4.

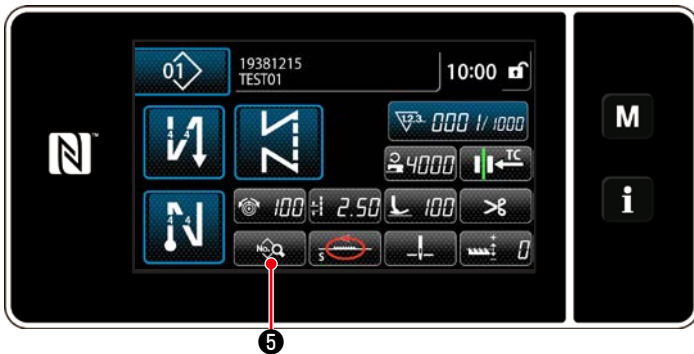

[How to set the condensation stitch]

1) Display the sewing data edit screen by pressing  5.



2) Display "S046 Shorter thread remaining" by pressing  6.



3) Set the shorter-thread remaining thread trimming function in the ON/OFF state (With/without condensation stitch).

4) Confirm your entry by pressing  7.

5) Display the sewing screen by pressing  8.



The condensation operation should be turned OFF before thread trimming is performed at a position where there is no material since thread loop formation at the time of thread trimming becomes unstable.

In addition, the thread take-up spring stroke should be adjusted to be slightly larger.

"How to adjust condensation pitch"

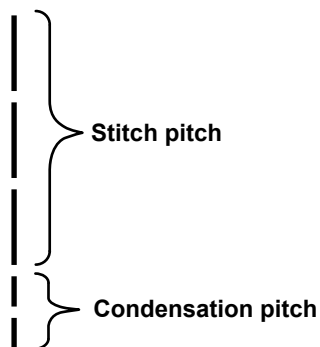

In the case of carrying out shorter-thread remaining thread trimming (when condensation is placed in ON), set values of the condensation pitch and the number of stitches are adjustable. Adjust those set values appropriately according to the item to be sewn.

[Setting the number of condensation stitches]

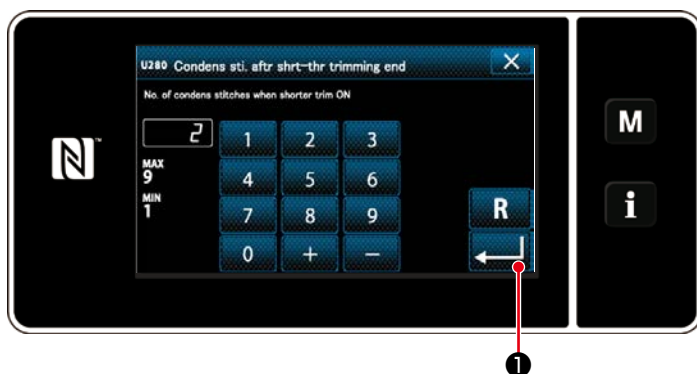

- 1) Select "U280 Number of end condensation stitches for shorter-thread remaining thread trimming" from "1. Display all".
- 2) Set the number of stitches.
(Factory-set value: 2)
- 3) Confirm your entry by pressing  ①. Then, the sewing screen is displayed.

[Setting the condensation pitch]

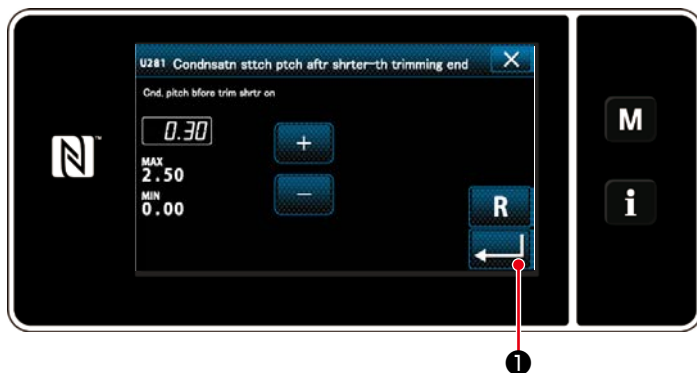

- 1) Select "U281 End condensation pitch for shorter-thread remaining thread trimming" from "1. Display all".
- 2) Set the number of stitches.
(Factory-set value 0.3; H type 0.5)
- 3) Confirm your entry by pressing  ①. Then, the sewing screen is displayed.



If the condensation pitch is decreased, the phenomenon where the needle enters the same needle entry point will likely to occur, resulting in unstable formation of thread loop at the time of thread trimming. As a result, thread trimming fault is likely to occur. It is therefore necessary to adjust the condensation pitch carefully. (The needle entry phenomenon differs according to the material to be sewn and the needle count, the pitch should be increased if thread trimming failure occurs.)



5-2. Adjusting the feed dog height

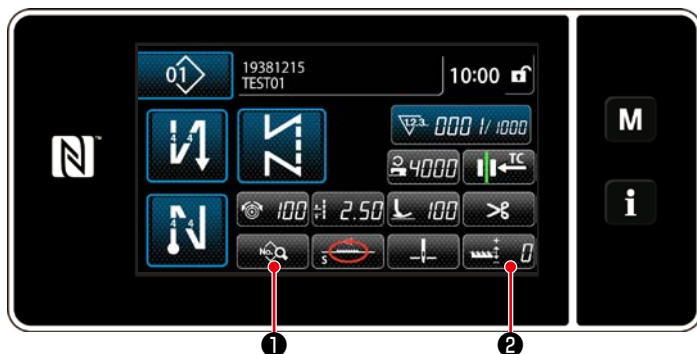

1. Be aware that interference between the throat plate and feed dog can occur depending on the gauge used. Be sure to check the clearance in the gauge to be used. (The clearance must be 0.5 mm or more.)
2. When you have changed the stitch length, feed dog height or feed timing, run the sewing machine at a low speed to make sure that the gauge does not interfere with the changed part.







"How to adjust"

- 1) Display the sewing data edit screen by pressing  ①.
Or, display "S050 Feed dog height" by pressing  ②.

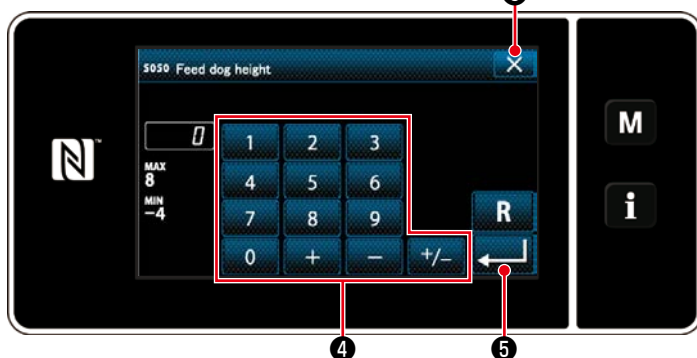

- 2) Display "S050 Feed dog height" by pressing  ③.



- 3) Change the feed dog height by pressing ten keys and  ④.
* Refer to the following for the adjustable range of the feed dog height.
- 4) Confirm your entry by pressing  ⑤.
- 5) Display the sewing screen by pressing  ⑥.

"DDL-9000C-FMS, FDS"

Feed dog height (mm)	0.60	0.65	0.70	0.75	0.80	0.85	0.90	0.95	1.00	1.05	1.10	1.15	1.20
Input value on the panel	-4	-3	-2	-1	0	1	2	3	4	5	6	7	8

Low ←←←

↑

→→→ High

Standard

(Factory-setting at the time of shipment)

"DDL-9000C-FSH"

Feed dog height (mm)	1.00	1.05	1.10	1.15	1.20	1.25	1.30	1.35	1.40	1.45	1.50	1.55	1.60
Input value on the panel	-4	-3	-2	-1	0	1	2	3	4	5	6	7	8

Low ←←←

↑

→→→ High

Standard

(Factory-setting at the time of shipment)

* Range of input values on the panel is from -4 to 8.

5-3. Operating timing of the feed



When you have changed the stitch length, feed dog height or feed timing, run the sewing machine at a low speed to make sure that the gauge does not interfere with the changed part.

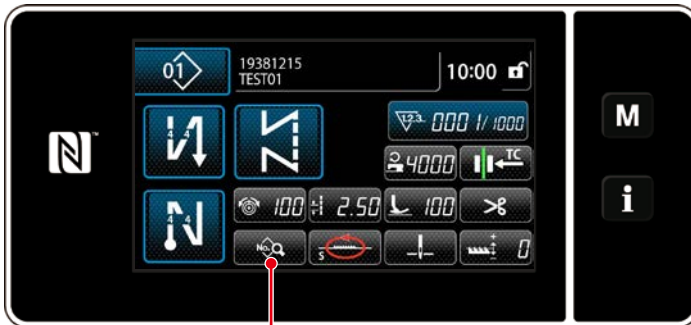

Timing between the needle and feed can be adjusted on the operation panel.



[How to adjust]

1) Display the sewing data edit screen by pressing  ①.

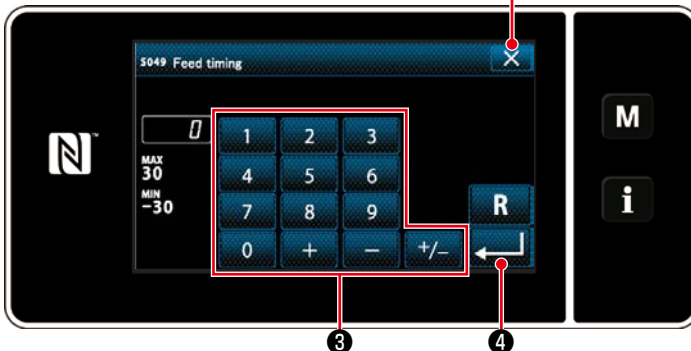

2) Display "S049 Feed timing" by pressing  ②.



3) Change the feed timing by pressing ten keys and   ③.
(+ : To advance; - : To retard)

4) Confirm your entry by pressing  ④.

5) Display the sewing screen by pressing  ⑤.

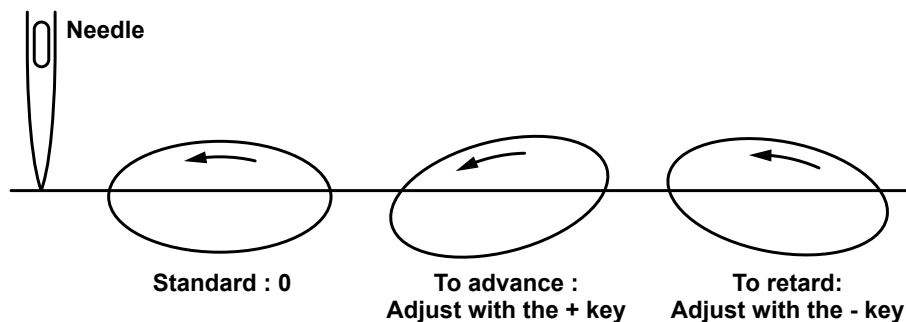

1. The feed timing differs with the set value. (Image figure as observed from the face plate side)

2. The stitch length changes by adjusting the feed timing. Carry out adjustment while actually carrying out sewing for the purpose of checking the stitch length.

5-4. Changing the feed locus

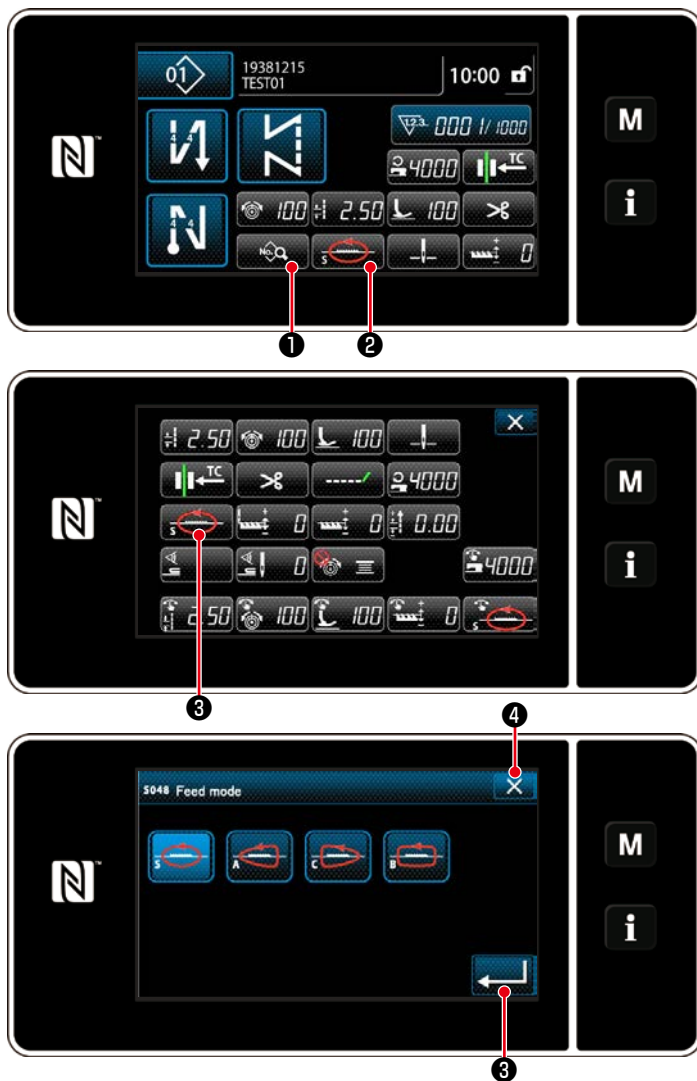

The feed locus can be changed according to the item to be sewn.

[How to change]

- 1) Display the sewing data edit screen by pressing ①.
Or, display "S048 Feed mode" by pressing ②.
- 2) Display "S048 Feed mode" by pressing ③.
- 3) Change the feed locus.
* Refer to the following for the types of feed locus.
- 4) Confirm your entry by pressing ④.
- 5) Display the sewing screen by pressing ⑤.

Feed locus (shape) "Image figure"	Name	Characteristics (movement of the feed dog)	Stitch length and sewing speed
	S (Standard)	Standard smooth elliptical locus.	[DDL-9000C-FMS, FSH] 0 to 4.00 mm : 5,000 sti/min (H type : 4,500 sti/min) 4.05 to 5.00 mm : 4,000 sti/min [DDL-9000C-FDS] 0 to 5.00 mm : 4,000 sti/min
	A	During ascending, the feed dog goes straight up and moves in parallel in terms of longitudinal direction.	0 to 5.00 mm : 4,000 sti/min
	C	When the needle penetrates the material, the feed dog sinks straight down. As a result, the bent-needle problem rarely occurs.	0 to 5.00 mm : 4,000 sti/min
	B	The feed dog goes straight up and sinks straight down. Since it sinks straight down during descending, the bent-needle problem rarely occurs. With this type of locus, the stitch length does not change largely even when the feed dog height is changed.	0 to 5.00 mm : 2,500 sti/min

6. CARE

Perform the maintenance below every day for longer use of your machine.

6-1. Maintenance mode

The maintenance mode should be used for maintenance of the sewing machine.



While the sewing machine is placed in the maintenance mode, it will not start even if the pedal is depressed.

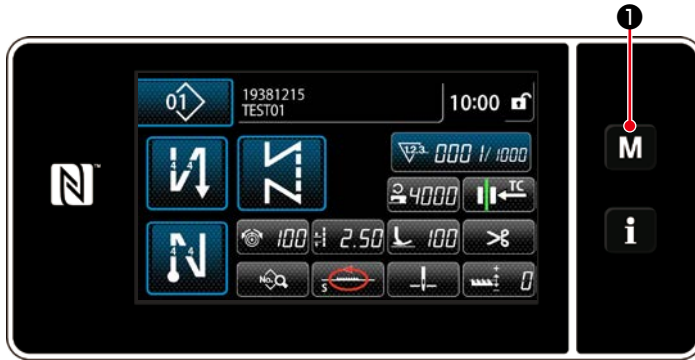

1) Display the mode screen by pressing

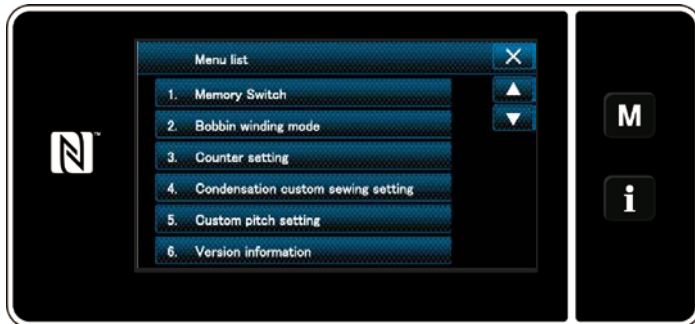

2) The screen is changed over to the maintenance mode screen.



Be sure to check that the screen has changed to the maintenance mode screen so as to prevent accidents caused by abrupt start of the sewing machine.

6-2. Confirmation of the amount of oil in the hook oil tank (DDL-9000C-FMS, FSH)



WARNING :

Turn OFF the power before starting the work so as to prevent accidents caused by abrupt start of the sewing machine.

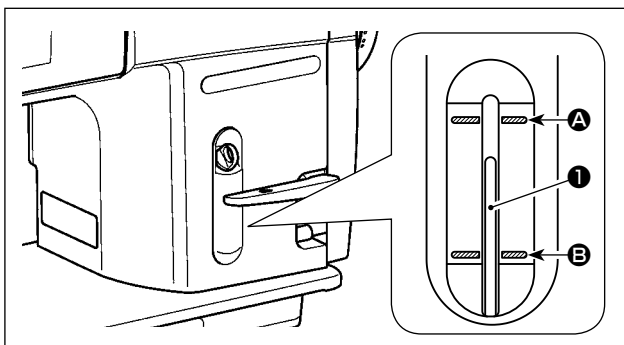

Confirm that the top of oil amount indicating rod ① is between the upper engraved marker line ① and the lower engraved marker line ② of the oil amount indicating window. (For the details, refer to "2-12. Lubrication (DDL-9000C-FMS, FSH)" p. 11.)

6-3. Cleaning the area around the hook



WARNING :

Turn OFF the power before starting the work so as to prevent accidents caused by abrupt start of the sewing machine.

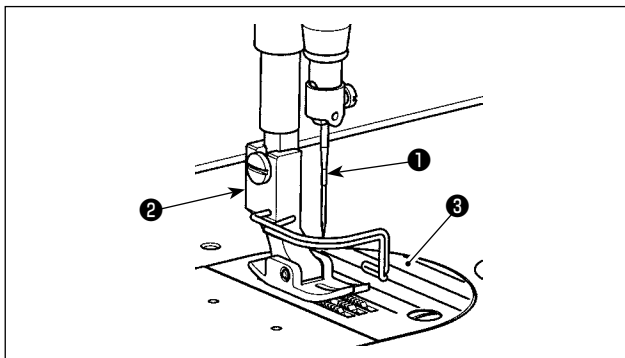

- 1) Remove needle ①, presser foot ② and throat plate ③.

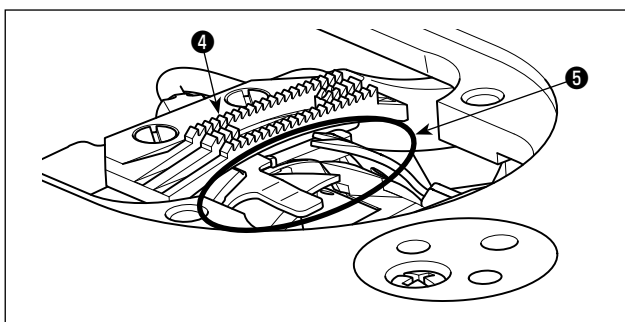

- 2) Remove dust adhered to feed dog ④ and thread trimmer unit ⑤ with a soft brush or cloth.

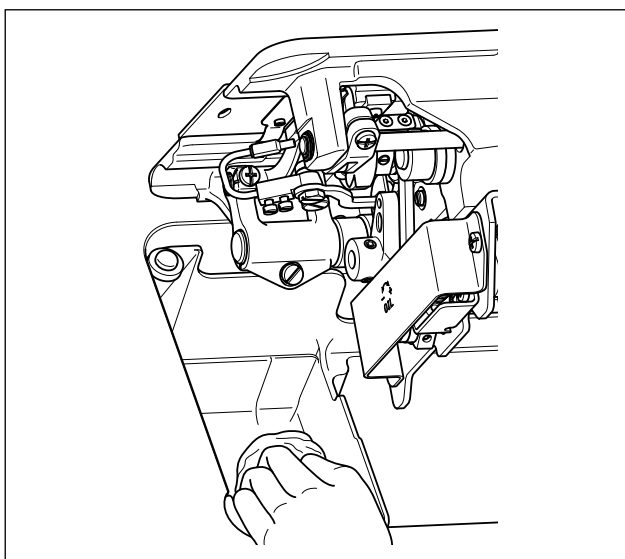

- 3) Tilt the machine head and wipe out the dirt of bobbin case and the like with soft cloth, and confirm that there is no scratch. Wipe out with the cloth dust and hook oil drained in the under cover near the hook.

6-4. Cleaning the interior of the frame



WARNING :

Turn OFF the power before starting the work so as to prevent accidents caused by abrupt start of the sewing machine.

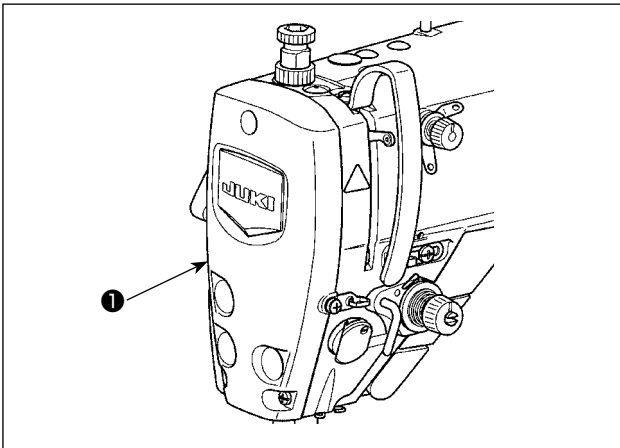

- 1) Remove face plate ❶.

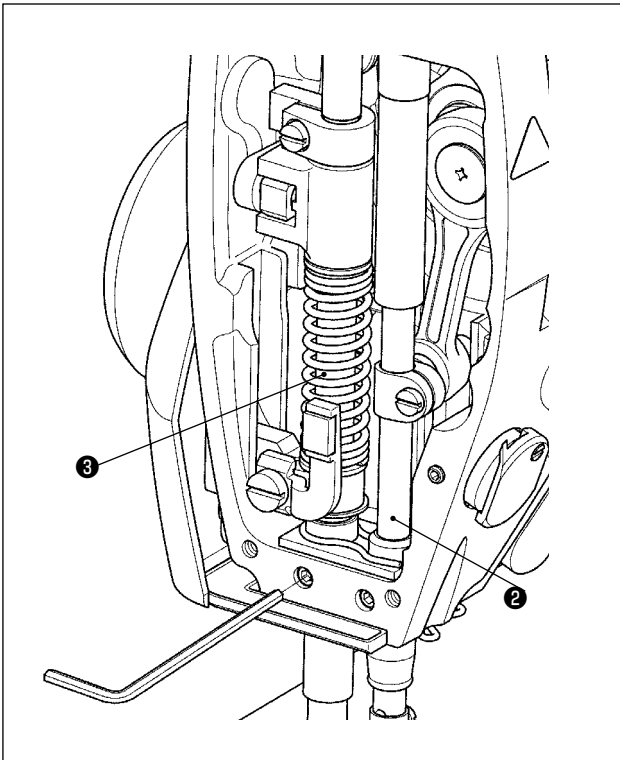

- 2) Remove dust stuck the parts inside the frame such as needle bar ❷ and presser bar ❸ with a soft brush or a piece of soft cloth.
- 3) After the completion of cleaning, add grease to the needle bar and the presser bar. Then, attach face plate ❶.

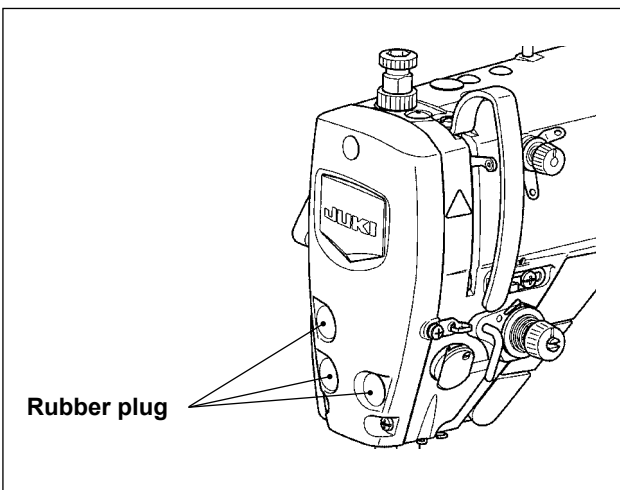

Be sure to attach the rubber plug back in place if you have removed it before cleaning.

6-5. Applying grease



WARNING :

Turn OFF the power before starting the work so as to prevent accidents caused by abrupt start of the sewing machine.



1. When the machine needs replenishment of grease, an alarm sounds. Once the alarm sounds, replenish grease. In the case the machine is used under harsh environment, it is recommended to replenish grease once a year for ensuring effective greasing.
2. Do not apply oil to the sections which are lubricated with grease.
3. Be aware that grease can leak from the thread take-up cover and needle bar if the amount of grease is excessive.
4. Be sure to use JUKI GREASE A TUBE ❶ (part number : 40006323).

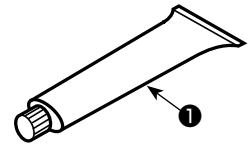

6-6. Applying grease to the needle bar lower bushing and the presser bar bushing



WARNING :

Turn OFF the power before starting the work so as to prevent accidents caused by abrupt start of the sewing machine.



Carry out greasing with the needle bar installed.

- 1) Remove the face plate.
- 2) Remove presser bar bushing greasing screw ❷ and needle bar lower bushing greasing screw ❸ (only for the DDL-9000C-FMS, FDS) with a hexagonal wrench.

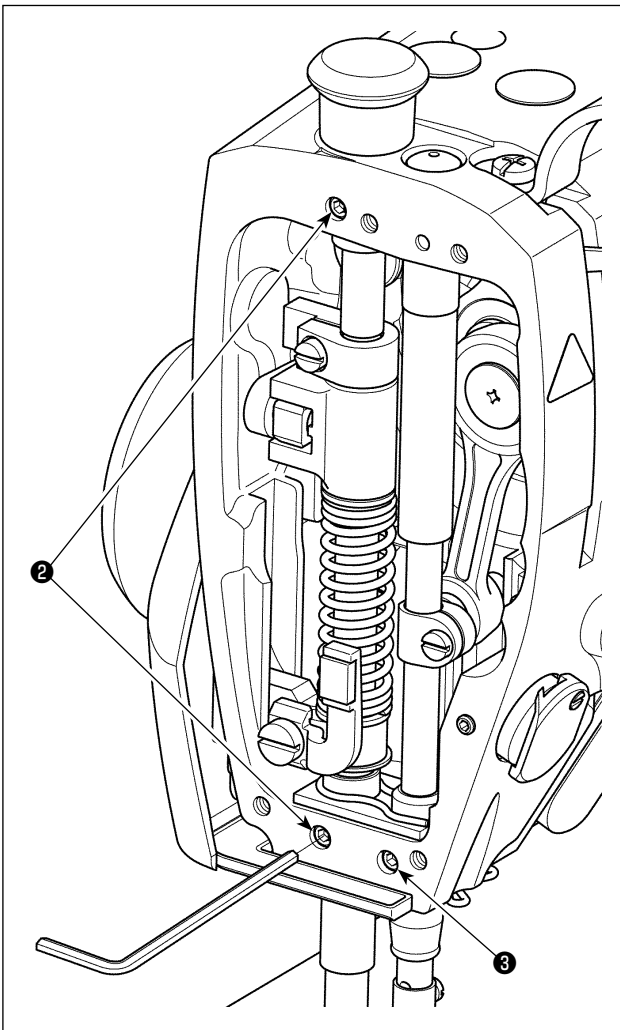

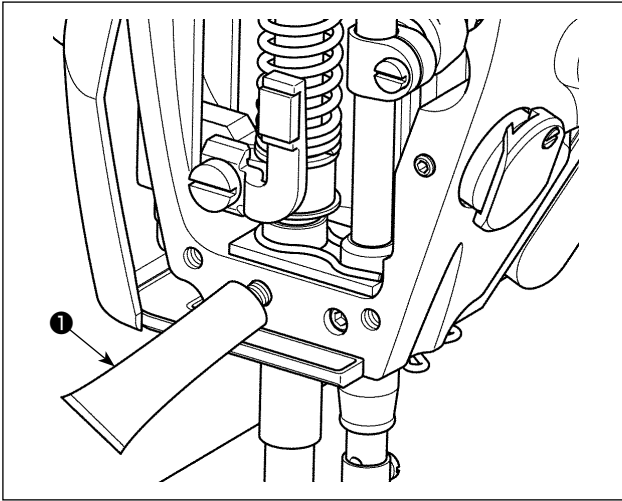

- 3) Remove the cap of exclusive grease tube ❶. Insert its tip into the oil hole and replenish grease from exclusive grease tube ❶. At this time, add grease until it overflows the oil hole.
- 4) Push overflowing exclusive grease with the oil filling screw into the oil hole.
- 5) Wipe the excess of grease off the area around the oil hole.

6-7. Replacing the fuse



DANGER :

1. To avoid electrical shock hazards, turn OFF the power and open the control box cover after about five minutes have passed.
2. Open the control box cover after turning OFF the power without fail. Then, replace with a new fuse with the specified capacity.

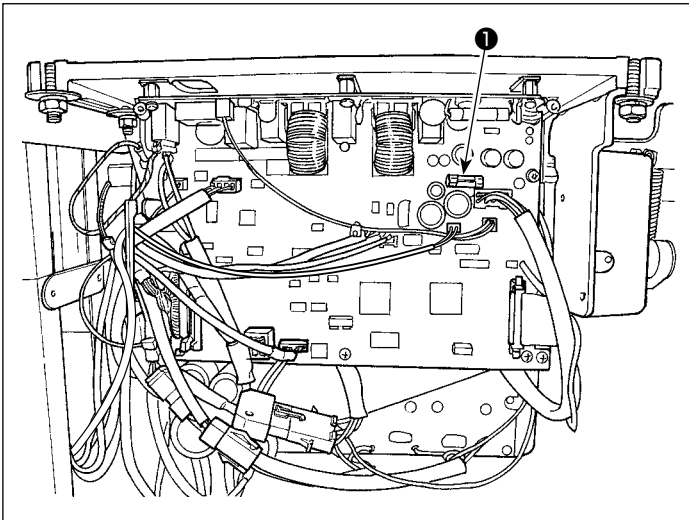

The machine uses the following one fuse :
MAIN PWB

- ❶ For 85V power supply protection
5A (time-lag fuse)

6-8. Disposal of batteries



The operation panel has a built-in battery in order to operate the clock even when the power is turned OFF. Be sure to dispose of the battery following the local laws and regulations.

[How to remove the battery]

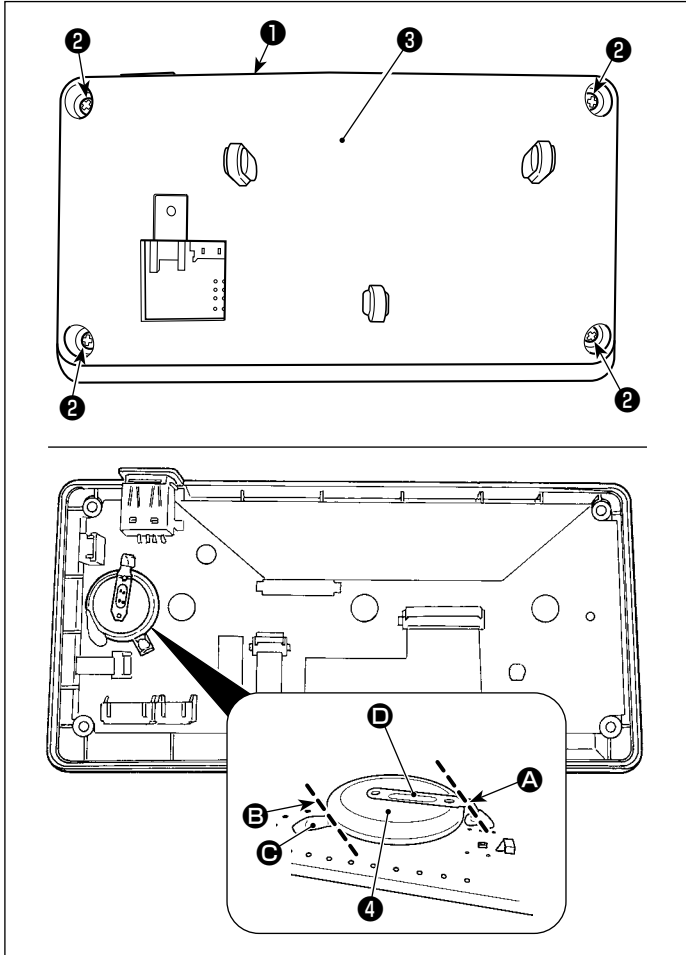

- 1) Remove panel ① from the main body of sewing machine.
- 2) Loosen screw ② from the rear surface of the operation panel. Detach case ③.
- 3) ④ is the battery for clock.
Type number: ML2020/F1AK
- 4) Cut metal plate ① that secures battery ④ with nippers or the like at position ②.
- 5) Cut metal plate ③ that secures battery ④ with nippers or the like at position ④. Then, remove battery ④.



Carefully protect your fingers from being cut with the cut edge of the metal plate.

7. ADJUSTMENT OF THE MACHINE HEAD (APPLICATION)

7-1. Needle-to-hook relationship



WARNING :

Turn OFF the power before starting the work so as to prevent accidents caused by abrupt start of the sewing machine.

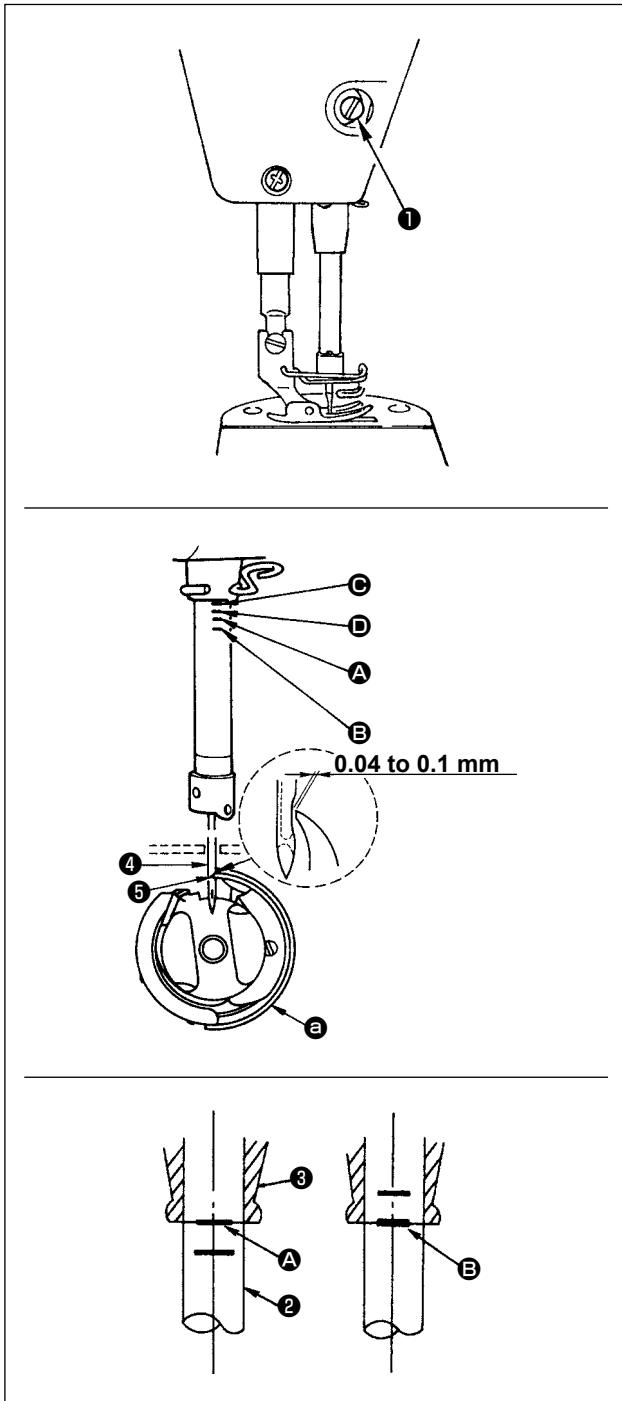

Adjust the timing between the needle and the hook as follows :

- 1) Adjusting the needle bar height. Turn the hand-wheel to bring the needle bar down to the lowest point of its stroke, and loosen setscrew ①.
- 2) Adjusting the needle bar height. Align marker line (For a DB needle : marker line ④, For a DA needle : marker line ③) on needle bar ② with the bottom end of needle bar lower bushing ③, then tighten setscrew ①.
- 3) Position the needle and the hook ⑤.
Loosen the three hook setscrews, turn the hand-wheel in normal rotation and align marker line (For a DB needle : marker line ④, For a DA needle : marker line ③) on ascending needle bar ② with the bottom end of needle bar lower bushing ③.
- 4) In this state, align hook blade point ⑤ with the center of needle ④. Provide a clearance of 0.04 to 0.1 mm (reference value) between the needle and the hook, then securely tighten the three hook setscrews.

1. If the clearance between the blade point of hook and the needle is smaller than the specified value, the blade point of hook will be damaged. If the clearance is larger, stitch skipping will result.



2. The needle bar of the DDL-9000C-FMS, FDS is processed with special black coating. In the case you find it difficult to visually check the location of marker lines, illuminate the needle bar with a flashlight or the like to make it easier.

7-2. Adjusting the needle thread presser device



WARNING :

Turn OFF the power before starting the work so as to prevent accidents caused by abrupt start of the sewing machine.

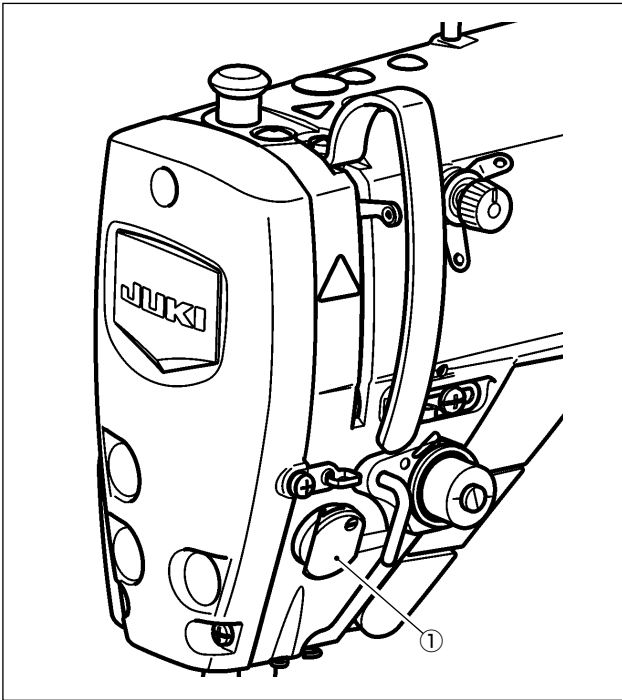

The needle thread presser device is able to tuck the needle thread on the wrong side of material as in the case of the conventional wiper device.

[Feature]

- So-called "bird's nest phenomenon" which appears on the wrong side of material can be reduced by using needle thread presser device ① in combination with condensation stitching.
- Operability around the needle entry point is improved.
- Applicability of various kinds of attachments designed for use around the needle entry point is improved.

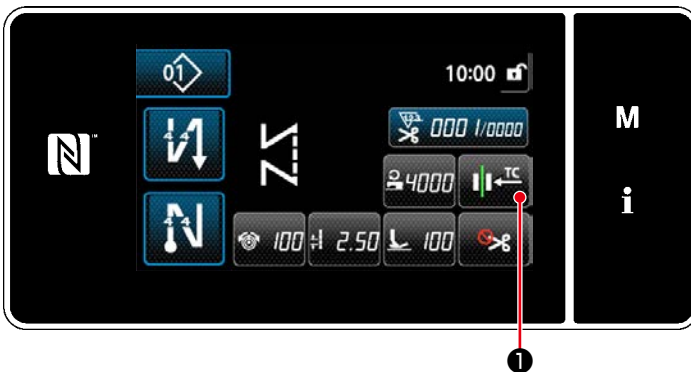

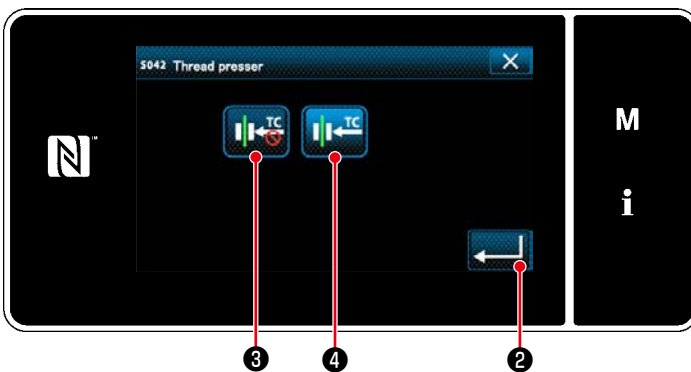

[How to set up the needle thread presser device]

- 1) Press  ①.



- 2) Press  ③ or  ④.

( ④ will be placed in ON.)

- 3) Press  ② to confirm the setting. Then, the sewing screen is displayed.



In the case the memory switch "U056 Reverse-rotation needle-up after thread trimming" is enabled, the length of needle thread becomes longer. So, in this case, the needle thread presser device should be set to "OFF".

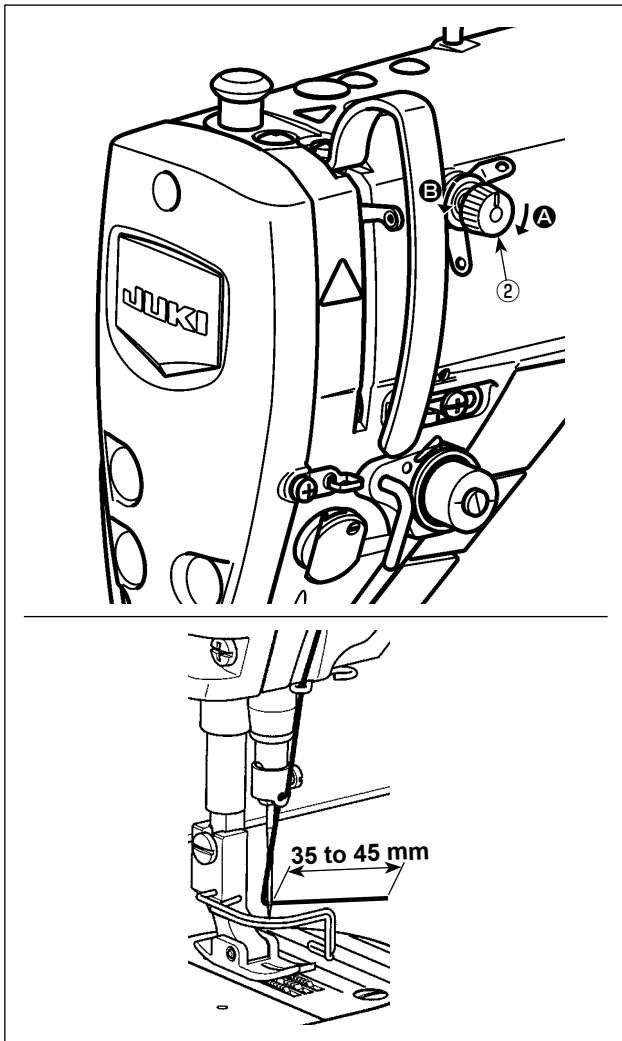

[Adjusting the remaining length of needle thread]

Adjust the length of needle thread remaining at the needle to 35 to 45 mm (for both the S and H types) by turning thread tension No. 1 nut ②.

- 1) Turn thread tension No. 1 nut ② clockwise (in direction **A**), to shorten the thread length remaining on the needle after thread trimming or counterclockwise (in direction **B**), to lengthen the thread length.

So-called "bird's nest phenomenon" is reduced by shortening the length of needle thread remaining at the needle. In this case, however, the needle thread is likely to slip off the needle eyelet. To reduce slip-off of the needle thread, sewing speed at the beginning of sewing should be reduced.



"Memory switch"

- U286 Sewing speed during thread presser operation : Reduce (Factory-adjusted to 300 sti/min at the time of shipment)
- U293 Sewing speed resetting angle when the thread presser operates : Retard (Factory-adjusted to 340 degrees at the time of shipment)

With respect to the memory switch settings, a sewing speed of 250 sti/min is recommended for "U286 Sewing speed during thread presser operation", and an angle of 720 degrees is recommended for "U293 Sewing speed resetting angle when the thread presser operates".



No.	Item	Setting range	Unit
U286	Sewing speed during thread presser operation This memory switch is used for setting the speed to be employed when the thread presser operates.	100 to 3000	sti/min
U293	Sewing speed resetting angle when the thread presser operates This memory switch is used for setting the angle at which the sewing speed employed when the thread presser operates is reset. * The setting is enabled when the thread presser operates.	0 to 720	Degree

[To reduce bird's nest (thread tangling) at the beginning of sewing]

In addition to the aforementioned adjustment, so-called "bird's nest phenomenon" is reduced by increasing the pitch of the first stitch at the beginning of sewing.

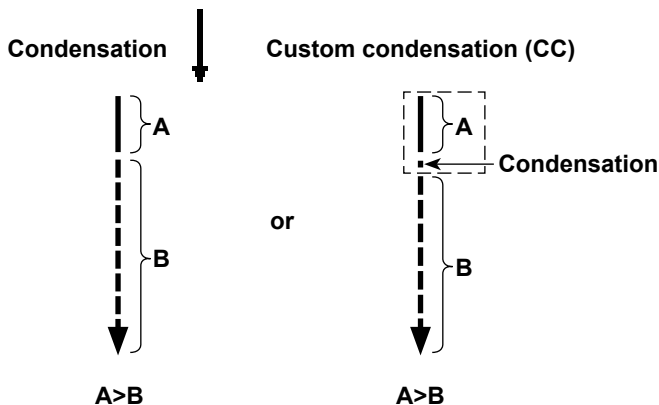

A : Stitch pitch of the first stitch
B : Normal stitch pitch

[Response to problems occurring at the beginning of sewing]

- In the case needle thread breakage occurs when using a thin thread or fragile thread
- In the case needle thread is not tucked on the wrong side of material
- In the case needle thread breakage occurs when starting sewing from the material end (such as sewing the material with needle thread tucked on the undersurface of material)

In the case any of the aforementioned problems occurs, the assist function which reduces the presser foot pressure at the beginning sewing can be set by using the active presser lifting device.

* In the case the assist function is not used, adjustment should be carried out to allow the needle thread placed between the presser foot and the material to smoothly come out from between them by decreasing the presser foot pressure. (The recommended presser foot pressure is 30 N (3 kg) or less.)

Adjust the presser foot pressure and the sewing speed appropriately to prevent insufficient feed efficiency due to jumping or other faults of the presser foot. Confirm the adjustment result by actually sewing the material.



[How to set the active-presser assist function]

- 1) Enter the presser foot lift setting time with "U290".
- 2) Press  ① to confirm the entered value.

Factory-set value : 20

 1. The amount of uplift of the presser foot above the throat plate varies according to the material thickness of the item to be sewn and the presser foot pressure. Be sure to check the actual condition before starting sewing.

2. If the adjustment value of the operating time of the AK-154 is increased while the presser foot pressure is high, the operating noise will become larger. Adjust the adjustment value of the operating time of the AK-154 and the pressure foot pressure while visually checking the needle thread.

7-3. Adjusting the thread trimmer



WARNING :

Turn OFF the power before starting the work so as to prevent accidents caused by abrupt start of the sewing machine.

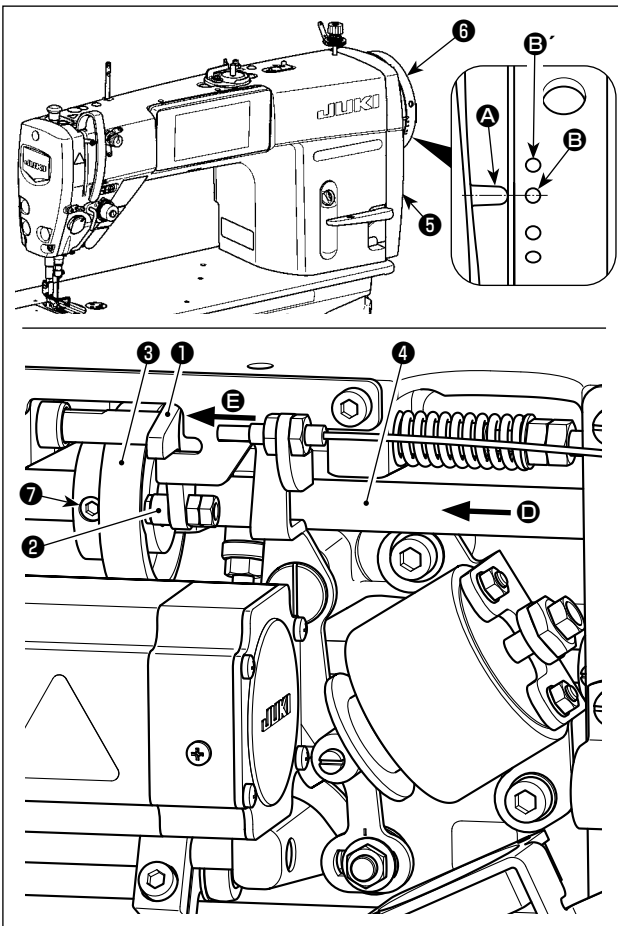

Turn thread trimming cam ③ in the direction of arrow until the outer periphery of thread trimming cam groove ② comes in contact with roller ② and stops. At this position, fix thread trimming cam setscrew ⑦.

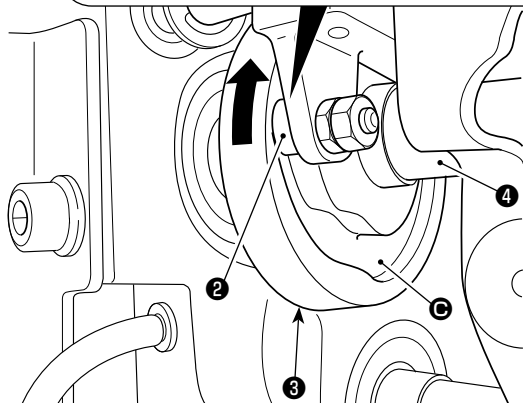
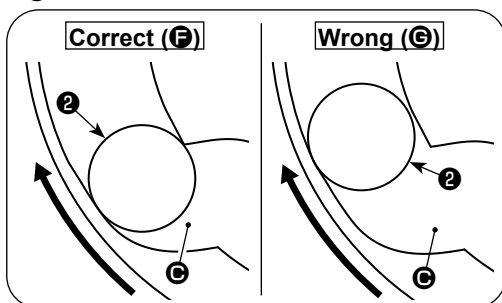

Illustration as observed from D (right side face)

7-3-1. For checking of the thread trimming cam timing

The purpose of the adjustment of the thread trimming cam is to align marker line A on pulley cover ⑤ with green marker dot B (H type : White marker dot B') on handwheel ⑥.

- 1) Tilt the sewing machine head.
- 2) Turn handwheel ⑥ by hand in the normal direction of rotation until the thread take-up lever goes up slightly below the upper dead point. Press cam follower ① with fingers to the left (in direction of arrow E) to fit roller ② to in groove C in thread trimming cam ③.
- 3) In this state, turn handwheel ⑥ in the direction which is opposite to the normal direction of rotation until handwheel ⑥ will go no further. (If the handwheel is turned further, it reaches the position at which cam follower ① starts moving.) At this time, marker line A on pulley cover ⑤ aligns with green marker dot B on handwheel ⑥.

7-3-2. Adjustment of the thread trimming cam timing

- 1) Tilt the sewing machine head.
- 2) Loosen the screws No. 2 and No. 1 of thread trimming cam setscrew ⑦ in the written order.
- 3) Align marker line A on pulley cover ⑤ with green marker dot B (H type : White marker dot B') on handwheel ⑥.
- 4) Pressing cam follower ① to the left (in the direction of arrow E), engage thread trimming cam ③ with roller ②. Then, turn only thread trimming cam ③ with fingers in the direction which is opposite to the normal direction of rotation of feed driving shaft ④ until it will go no further without turning feed driving shaft ④. At this position, tighten the screws No. 1 and No. 2 of thread trimming cam setscrew ⑦ in the written order while pressing thread trimming cam ③ against roller ②.

1. In the case of using a high-count filament thread, thread loop formation may be unstable. If faulty loop spreading occurs in this state, correct the thread trimming cam timing by aligning the marker line on the pulley cover with the red marker dot, instead of the green marker dot, on the handwheel.

2. The alignment point between thread trimming cam ③ and roller ② is position (F) from which cam follower ① starts moving. Position (G) at which you feel that thread trimming cam ③ comes in contact with roller ② for the first time during adjustment is not the correct alignment position.

*** Be sure to correct the thread trimming cam timing carefully since it largely affects the loop spreading timing.**



7-3-3. Checking of the knife unit



WARNING :

Turn OFF the power before starting the work so as to prevent accidents caused by abrupt start of the sewing machine.

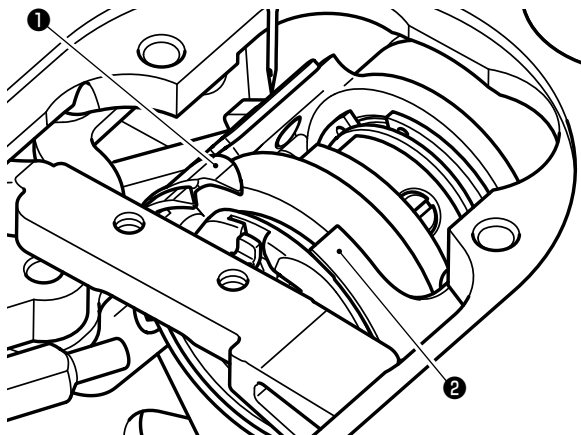

Standby state of the knife

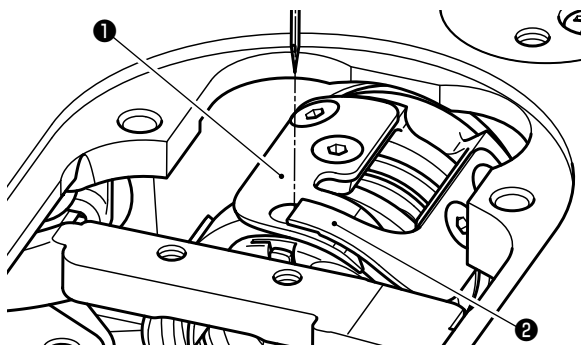
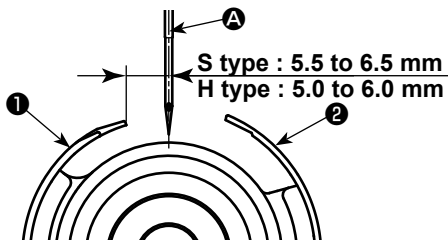

Aligning state of salient portion of loop spreading knife and thread trimming knife

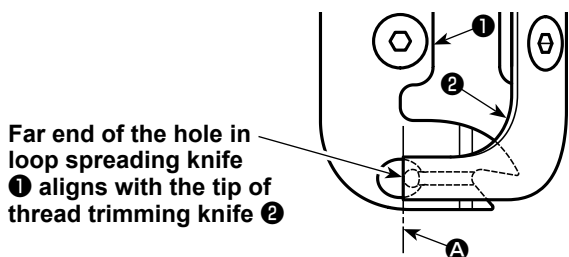

Far end of the hole in loop spreading knife ① aligns with the tip of thread trimming knife ②

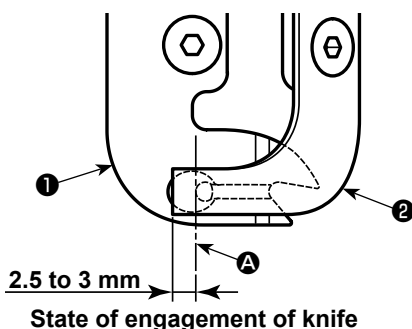

State of engagement of knife

- 1) Check to make sure that the power switch is in the OFF state. Remove the gauge (presser foot, throat plate and feed dog) from around the needle.
- 2) In the standby state of loop spreading knife ①, the distance from center of needle A to the tip of loop spreading knife ① is 5.5 to 6.5 mm (H type: 5.0 to 6.0 mm).



Be aware that, if the distance between loop spreading knife ① and center of needle A is reduced, thread loop is likely to interfere with loop spreading knife ①.

* Refer to "7-3-4. Adjustment of the knife unit" p. 93 for how to adjust it.

- 3) The purpose of adjustment of the aligning position of loop spreading knife ① and thread trimming knife ② (far end of the hole in loop spreading knife ① and the tip of thread trimming knife ②) is to align the aforementioned aligning position with center of needle A.



Be aware that, if the aligning position of the loop spreading knife and the thread trimming knife does not align with center of needle A, the length of thread remaining on the material after thread trimming will be longer.

- 4) The amount of engagement between loop spreading knife ① and thread trimming knife ② is 2.5 to 3 mm as measured from center of needle A.



Be aware that, if the amount of engagement between them is insufficient, faulty thread trimming can occur.

* Refer to "7-3-4. Adjustment of the knife unit" p. 93 for how to adjust it.

The needle thread may be trimmed excessively short in the case thread such as filament thread which is likely to cause unstable thread loop formation is used or thread trimming is carried out at a position where there is no material. If the aforementioned phenomenon occurs, it should be corrected by carrying out the below-stated procedure.



- Make the thread take-up spring stroke larger than the standard value.
- Make the pitch for thread trimming during condensation stitch larger than the standard pitch.
- Turn OFF the condensation stitch operation when carrying out thread trimming at a position where there is no material.

7-3-4. Adjustment of the knife unit



WARNING :

Turn OFF the power before starting the work so as to prevent accidents caused by abrupt start of the sewing machine.

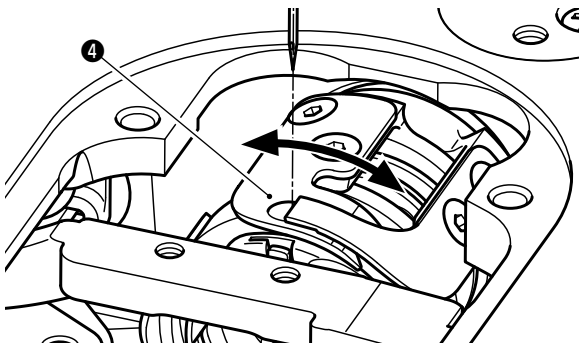
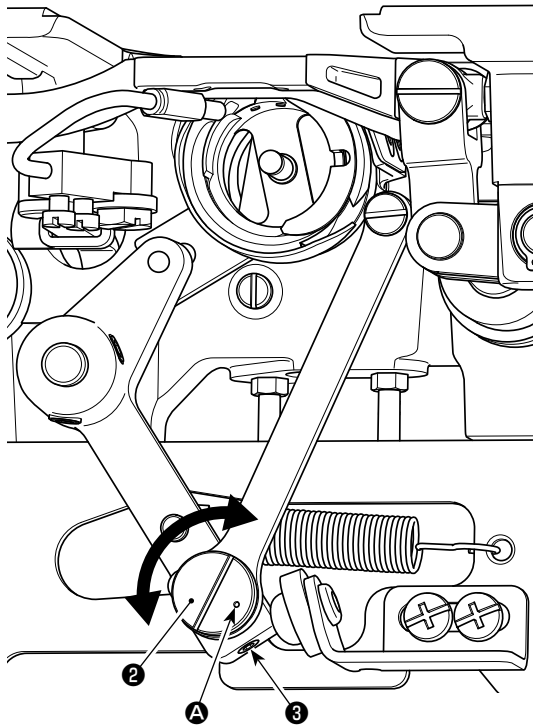
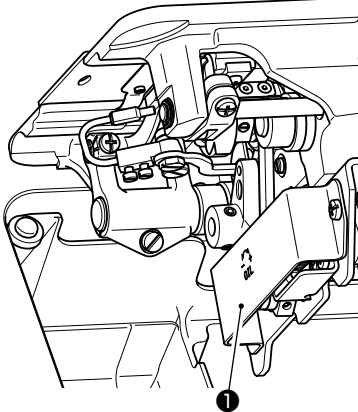

- 1) Check to make sure that the power switch is in the OFF state. Remove the gauge (presser foot, throat plate and feed dog) from around the needle.
- 2) Tilt the sewing machine head.
- 3) Remove protective cover ①.
- 4) Loosen loop spreading knife eccentric pin setscrews ③ (two pieces). Turn loop spreading knife eccentric pin ② with a flat-blade screwdriver to finely adjust the rotational-direction position of loop spreading knife ④.
- 5) After the adjustment, tighten loop spreading knife eccentric pin setscrews ③ (two pieces).
- 6) Attach protective cover ① back in place.



Position of marker dot A on loop spreading knife eccentric pin ② should be adjusted only from the operator's side.

7-3-5. Adjustment of thread trimming speed

The thread trimming speed has been adjusted to 300 sti/min (H type : 220 sti/min) at the time of shipment. This means that the high-speed thread trimming has been selected.

Depending on the type of thread to be used, the thread trimming speed should be increased. On the other hand, in the case of using fragile thread (such as a high-count filament type thread or cotton thread), the thread trimming speed should be decreased to reduce damage to the thread.

Thread trimming speed should be adjusted when appropriate according to the sewing process.



[How to adjust]

- 1) Press **M** ①.
Setting can be changed with "U036".

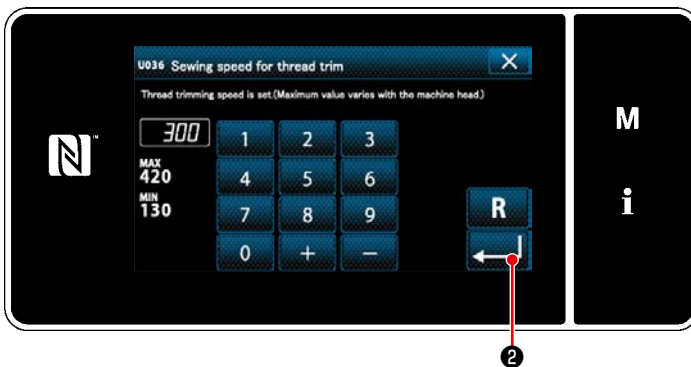

- 2) Enter a numerical value. Press  ② to change the setting.

No.	Item	Setting range	Unit
U036	Speed during thread trimming The maximum number of revolutions during thread trimming differs with the machine head.	130 to Max. of thread trimming	sti/min

7-4. Adjustment of the picker



WARNING :

Turn OFF the power before starting the work so as to prevent accidents caused by abrupt start of the sewing machine.

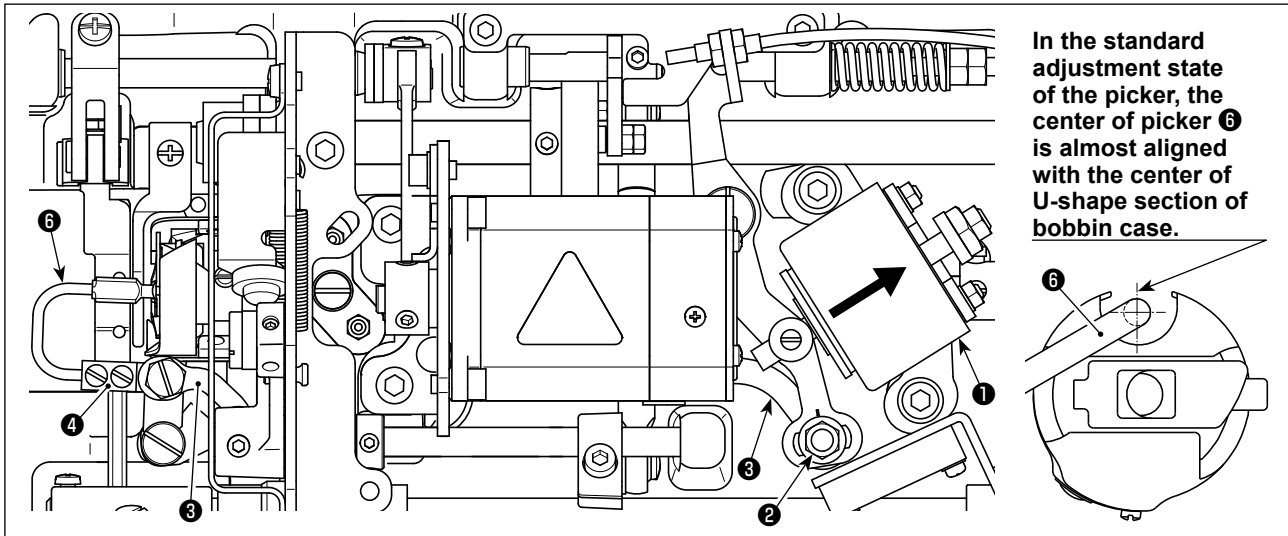

In the standard adjustment state of the picker, the center of picker ⑥ is almost aligned with the center of U-shape section of bobbin case.

Once the standard adjustment is carried out correctly, there is a slot-shape space in picker link ③ to allow the picker to make a necessary returning action (damper function).

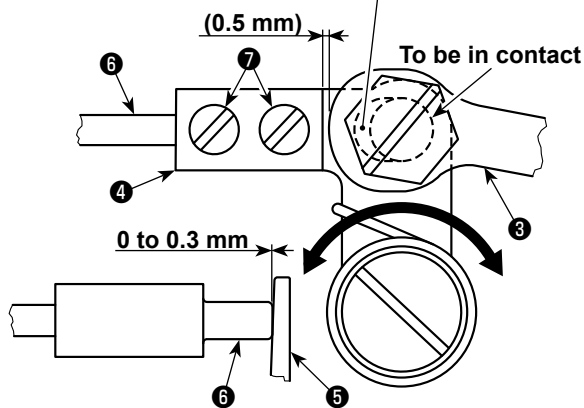

The picker device is used in order to stabilize idling of the bobbin at the time of thread trimming.



When it is necessary to check how the picker is adjusted, install the bobbin case and bobbin in the hook first, then check the picker.

7-4-1. Checking the standard adjustment

- 1) Check to make sure that the power switch is in the "OFF" state. Tilt the sewing machine.
- 2) Bring thread trimming solenoid ① in the pull-in state by hand.
- 3) In this state, the standard adjustment value of the clearance between picker link ③ and picker arm ④ is 0.5 mm. At this time, a clearance of 0 to 0.3 mm is provided between bobbin ⑤ and picker ⑥.

7-4-2. Standard adjustment

- 1) Loosen picker link pin nut ② (9 mm). Carry out adjustment by moving picker link ③ to the right and left.
- 2) After the adjustment, tighten picker link pin nut ②.

7-4-3. Standard adjustment (Adjustment at the tip position)

- 1) Loosen picker setscrews ⑦ (two pieces). Adjust the position of picker.
- 2) After the adjustment, tighten picker setscrews ⑦ (two pieces).



1. If there is no clearance between bobbin ⑤ and the tip of picker ⑥, picker ⑥ strongly press bobbin ⑤. As a result, the bobbin fails to supply a required length of bobbin thread at the time of thread trimming. In this case, the bobbin thread is likely to be trimmed short and thread slip-off at the beginning of sewing is likely to occur.
2. If there is an excessively large clearance between bobbin ⑤ and the tip of picker ⑥, thread required for thread trimming may slip off the tip of picker and the length of needle thread remaining at the needle tip after thread trimming will be short. In addition, bobbin ⑤ is likely to idle frequently at the time of thread trimming causing problems at the beginning of sewing.

7-5. Active-presser multi-layered section detection function

7-5-1. Multi-layered section detection function

This function allows detection of a multi-layered section of material. When a multi-layered section of material is detected, the sewing parameter is automatically changed to the one-touch changeover parameter ("4-2-9. One-touch utility changeover function" p.52) to allow the sewing machine to continue sewing. The multi-layered section detection setting can be stored in memory on a pattern-by-pattern basis.

Detectable material thickness : Max. 10 mm

Detection resolution : 0.1 mm

- * Multi-layered section of material that is less than 2 mm in thickness is likely to be affected by the feed dog height. Stable detection, therefore, cannot be carried out. It is not possible to detect two or more multi-layered sections thickness of which are different. In this case, the one-touch changeover function by means of the hand switch should be used.
- * The multi-layered section detection function is disabled while the one-touch changeover function by means of the hand switch is carried out.



1

<Sewing screen>

[In order to detect a multi-layered section]

1. Select enable/disable of the multi-layered section detection function.

1) Press  1.

The "sewing data edit screen" is displayed.



2

<Sewing data edit screen>

2) Press  2.

The "multi-layered section detection sensor value screen" is displayed.

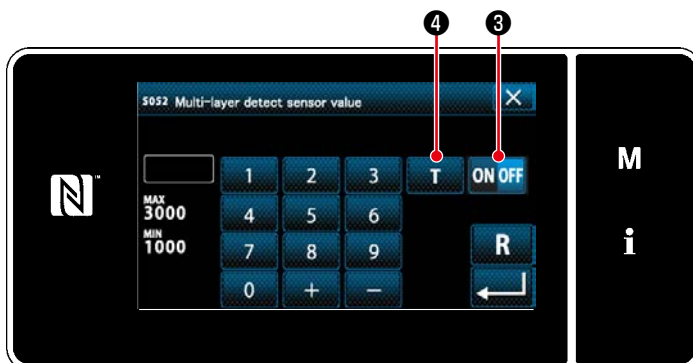

<Multi-layered section detection sensor value screen>

3) Enable the multi-layered section detection function by pressing  3. (This switch has been factory-set to OFF at the time of shipment.)

Set a "threshold" for the multi-layered section detection using multi-layered section height teaching function  4.

* For the purpose of the multi-layered section detection function, the word "threshold" means the value at which the multi-layered section sensor reacts.

Initial value MAX : 3000

MIN : 1000

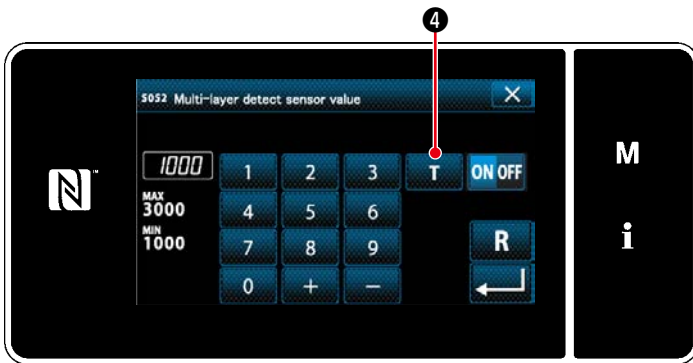

<Multi-layered section detection sensor value screen>

2. Set a "threshold" for the multi-layered section detection.

1) Press **T** ④.

The "multi-layered section threshold setting screen" is displayed.

2) Place the normal section of material under the presser foot, and press ⑤.
Lift the presser foot by depressing the back part of pedal.

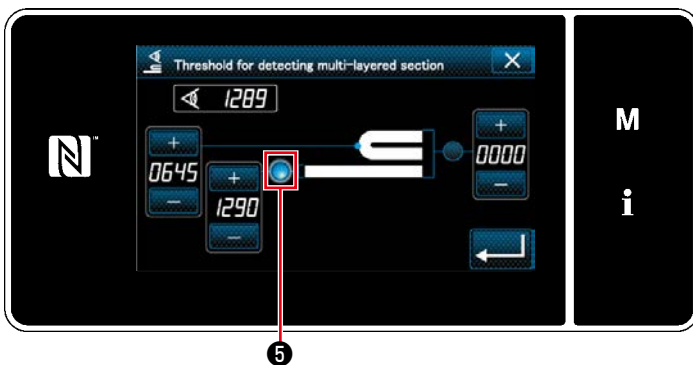

<Multi-layered section threshold setting screen>

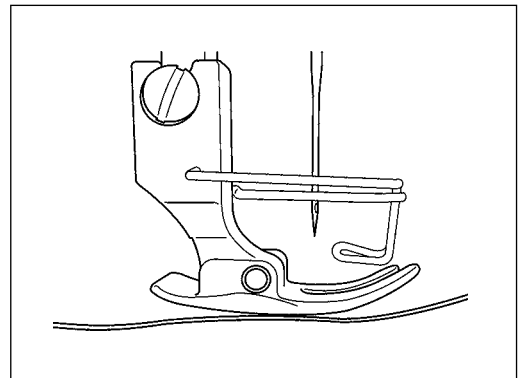

3) Place the multi-layered section of material under the presser foot, and press ⑥.

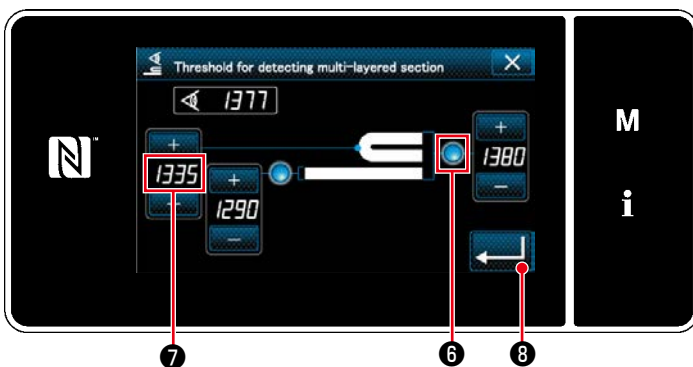

<Multi-layered section threshold setting screen>

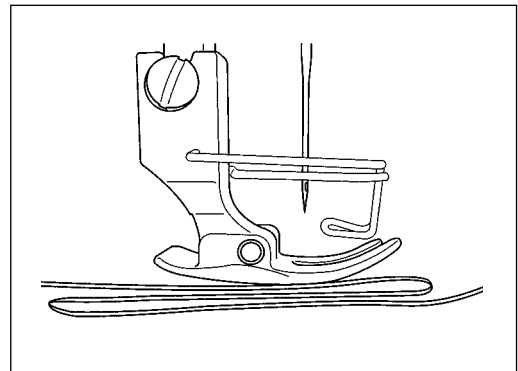

The value of ⑦ is automatically calculated, and that value becomes the "threshold" for the multi-layered section detection. The value is adjustable with **+** **-** according to the sewing item.



If the "threshold" is decreased, the multi-layered section can be detected earlier. Be aware that, excessively decreased threshold can cause a faulty detection.

Press **←** ⑧ to display the "multi-layered section detection sensor value screen".

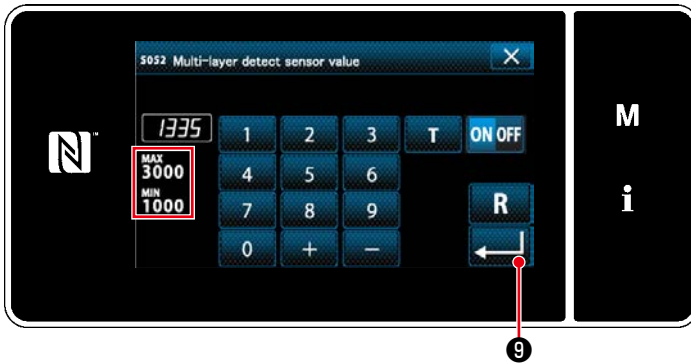

<Multi-layered section detection sensor value screen>

Check that the "threshold" you have set is entered. Then, press 9 again to confirm the setting. Note that the "threshold" can be directly entered or corrected on this screen.

MAX : 3000
MIN : 1000



The initial value of "threshold" for the multi-layered section detection is a rough indication. The threshold should be finely adjusted according to the actual sewing conditions such as the item to be sewn.

7-5-2. Multi-layered-section detection number of stitches setting function

In the case the multi-layered section detection is enabled, the sewing parameter is automatically returned to the setting for the normal section of material if the material thickness becomes smaller than the "threshold". However, the sewing-parameter changeover timing can be changed by setting the multi-layered-section detection number of stitches. Once the multi-layered-section detection number of stitches is set, the threshold returns to the value for the normal section of material when the aforementioned set number of stitches is reached after the detection of a multi-layered section of material, even if the sewing is started from the multi-layered section. It should be noted, however, that the sewing parameter returns to the one for the normal section of material if the material thickness falls below the "threshold" for the multi-layered section detection, even within the range of the set multi-layered-section detection number of stitches.

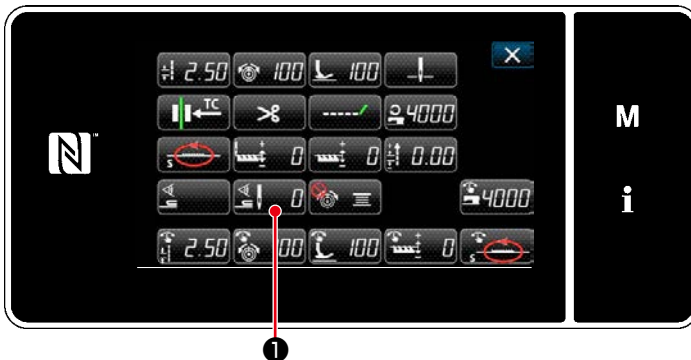

<Sewing data edit screen>

[How to set]

1) Press 1 on the "Sewing data edit screen".

The "multi-layered section detection sensor value screen" is displayed.

2) Enter the number of stitches with numeric keypad 2.

Press 3 to confirm the setting.



<Multi-layered section detection sensor value screen>

Factory-set value at the time of delivery

: 0 (Number of stitches is not set)

Setting range : 0 to 200

* When the number of stitches is set to zero (0), the setting of the multi-layered-section detection number of stitches is rendered invalid.

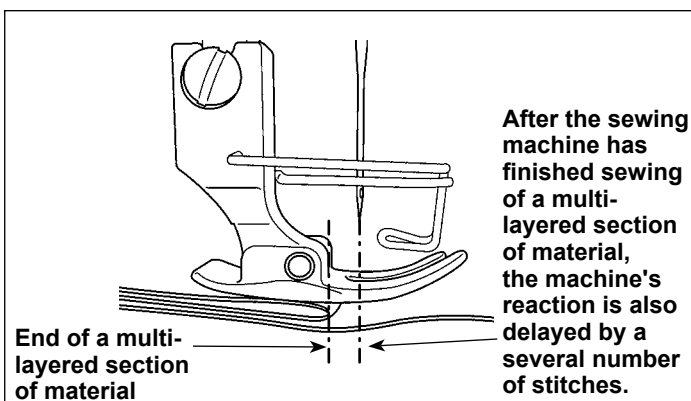

After the end of multi-layered section of material is fed, the multi-layered section detection function detects the flat section of material to return the sewing conditions to those for the flat section. However, this reaction sometimes delays according to the sewing conditions. If such a delay occurs, it can be corrected by setting the number of stitches of the multi-layered section detection.

7-6. Grease shortage alarm

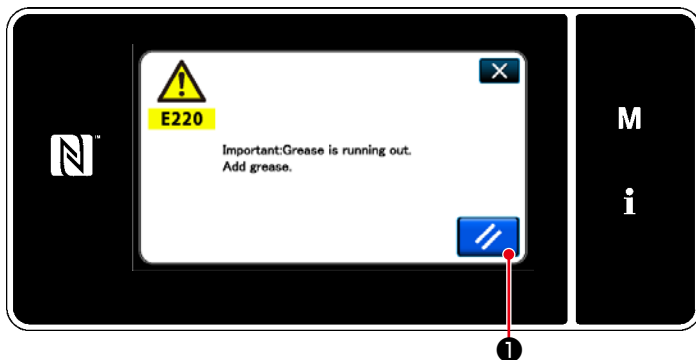

7-6-1. Regarding the grease shortage alarm

When the time of maintenance of grease approaches, the error message "E220 Warning against shortage of grease" is displayed.

This error is reset by pressing  ①. In this state, the sewing machine can be continuously used for a certain period of time.

 **Once the error message E220 is displayed, be sure to add grease for maintenance.**

* Refer to **"7-6-3. Regarding K118 error resetting procedure" p. 100** in the case of carrying out error resetting (K118).



7-6-2. E221 Grease-shortage error

If the error message "E220" is not reset, the error message "E221 Grease-shortage error" will be displayed.

In this case, the sewing machine operation is disabled. Be sure to add grease and carry out error resetting (K118).

* Refer to **"7-6-3. Regarding K118 error resetting procedure" p. 100** in the case of carrying out error resetting (K118).



<Sewing screen>

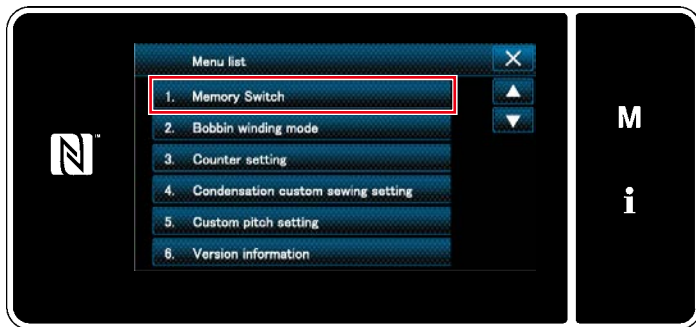

<Mode screen>

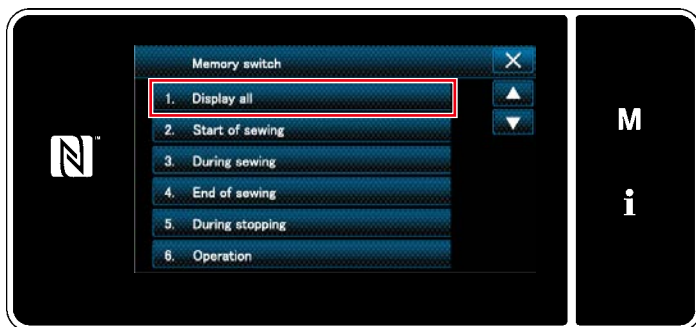

<Memory switch type selection screen>

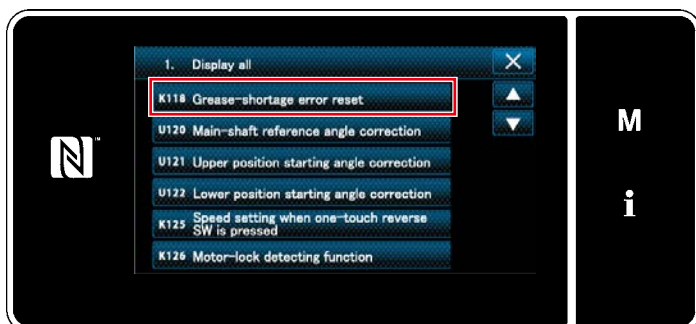

<Memory switch edit screen>



<Grease-shortage error reset screen>

7-6-3. Regarding K118 error resetting procedure

1) Keep **M** **1** held pressed for six seconds.

The "mode screen" is displayed.

2) Select the "1. Memory switch".

The "memory switch type selection screen" is displayed.

3) Select the "1. Display all".

The "memory switch edit screen" is displayed.

4) Select the "K118 Grease-shortage error reset".

The "Grease-shortage error reset screen" is displayed.

5) Set the set value to "1" using numeric keypad **2** and **+** **3**. Press **↵** **4** to confirm the setting.

This resets the error to bring the sewing machine back to the normal operation. The sewing machine can run normally until the next maintenance period is reached.

8. HOW TO USE THE OPERATION PANEL (APPLICATION)

8-1. Management of sewing patterns

8-1-1. Creation of a new pattern

A newly-created sewing pattern is registered by following the steps of procedure described below.

* This operation is to be carried out under the maintenance personnel mode.

① Selecting the new-pattern creating function



<Sewing screen (Maintenance personnel mode)>

1. Press  **1** on the sewing screen under the maintenance personnel mode. The "sewing pattern number list screen" is displayed.

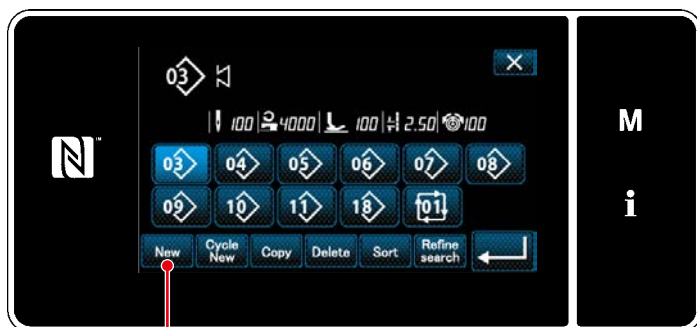

<Sewing pattern number list screen>

2. Press  **2**. The "new pattern creation screen" is displayed.

② Setting the feed locus of sewing pattern

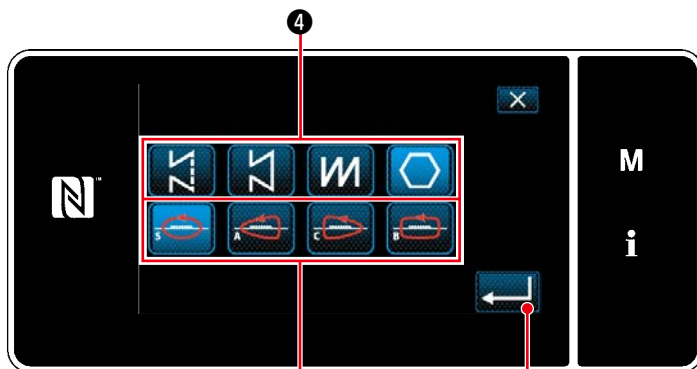

<New pattern creation screen>

1. Select feed locus **3**. (Feed locus changes.)
Select the stitch shape by pressing stitch shape button **4**.
2. Press  **5** to confirm the setting. The "new sewing pattern edit screen" is displayed.

③ Setting the pattern function

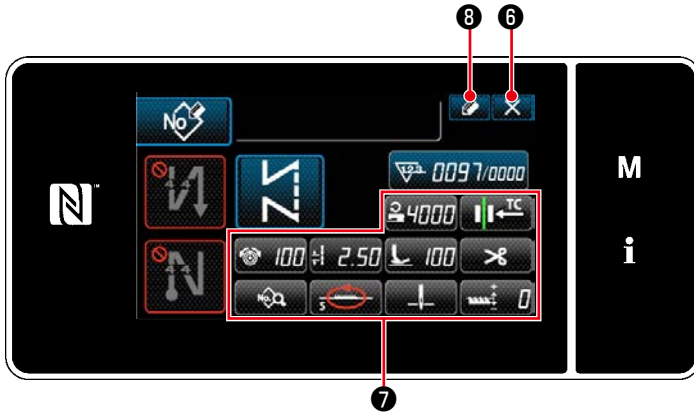

<New sewing pattern edit screen>

1. Set the pattern function using buttons 7 . Refer to "4-2. Sewing patterns" p.35.

2. Press 8 .

The "sewing pattern number registration screen" is displayed.

Press 6 to display the data discard confirmation screen.

④ Entering a pattern number and registering the pattern

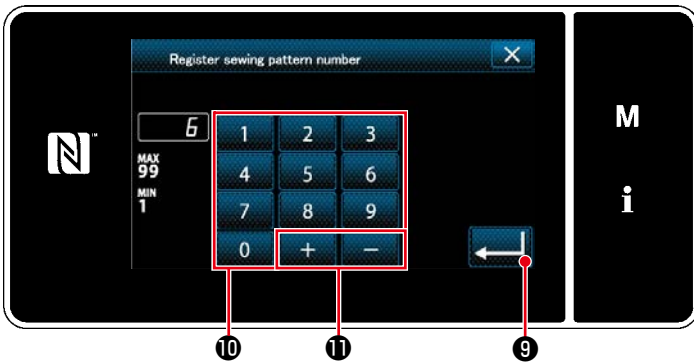

<Sewing pattern number registration screen>

1. Enter the sewing pattern number to be registered using numeric keypad 10 .

An unassigned registration number that is closest to the entered value in the plus/minus direction is displayed by pressing

11 .

2. The created pattern is registered by pressing 9 . Then, the current screen returns to the "sewing pattern number list screen".

In the case the entered number has already been registered, the prompt message for overwrite confirmation is displayed.

8-1-2. Copying a pattern

The selected pattern (sewing pattern and cycle pattern) can be copied to any other pattern of the specified number.

*** This operation is to be carried out under the maintenance personnel mode.**

Explanation is given below using copying of a sewing pattern as an example.

① Selecting the sewing pattern copy function

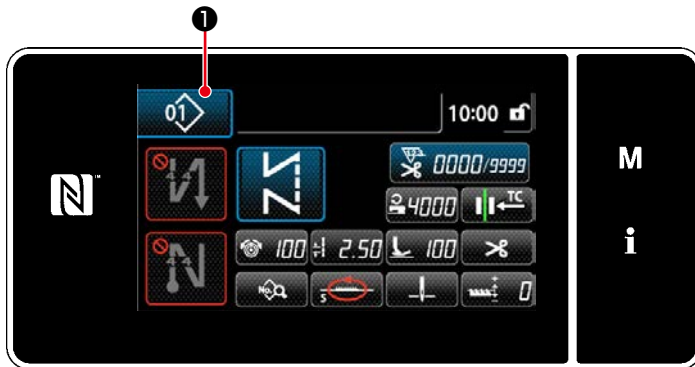

<Sewing screen (Maintenance personnel mode)>

1. Press  **1** on the sewing screen under the maintenance personnel mode. The "sewing pattern number list screen" is displayed.

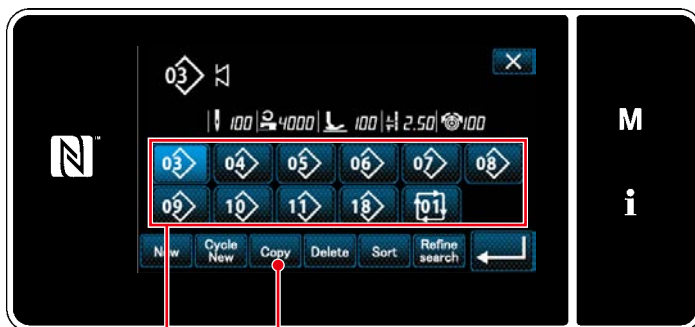

<Sewing pattern number list screen>



2. Select the copy source pattern number from list **2**.
3. Press  **3**.

The "sewing pattern number copy screen" is displayed.

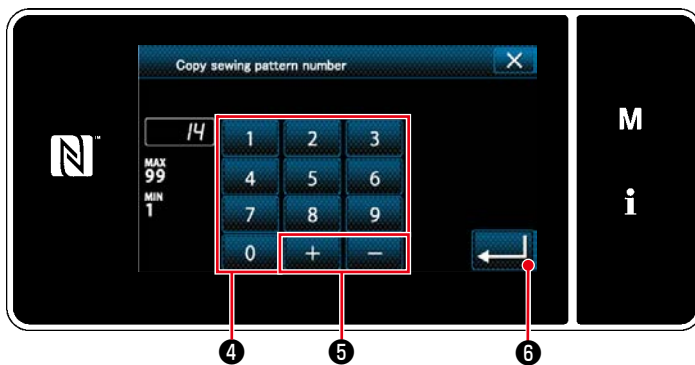
② Select the copy destination pattern number



<Sewing pattern number copy screen>

1. Enter the sewing pattern number to be registered using numeric keypad **4**.
An unassigned registration number that is closest to the entered value in the plus/minus direction is displayed by pressing  **5**.
2. The created pattern is registered by pressing  **6**. Then, the current screen returns to the "sewing pattern number list screen". In the case the entered number has already been registered, the prompt message for overwrite confirmation is displayed.

8-1-3. Deleting a pattern

This section describes how to delete the selected pattern (sewing pattern, cycle sewing pattern).

*** This operation is to be carried out under the maintenance personnel mode.**

① Selecting the sewing pattern deletion function

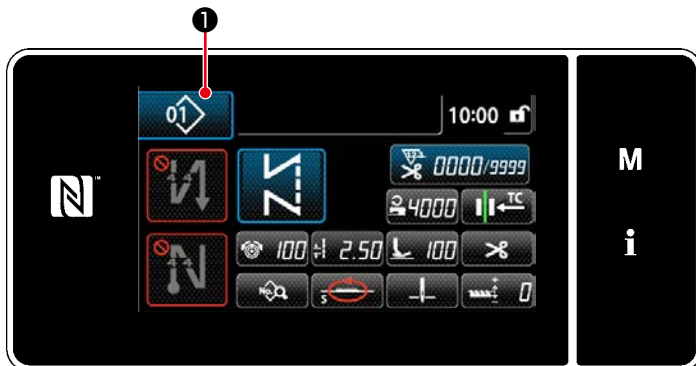

<Sewing screen (Maintenance personnel mode)>

Press  ① on the sewing screen under the maintenance personnel mode.

The "sewing pattern number list screen" is displayed.

② Selecting the sewing pattern and deleting it

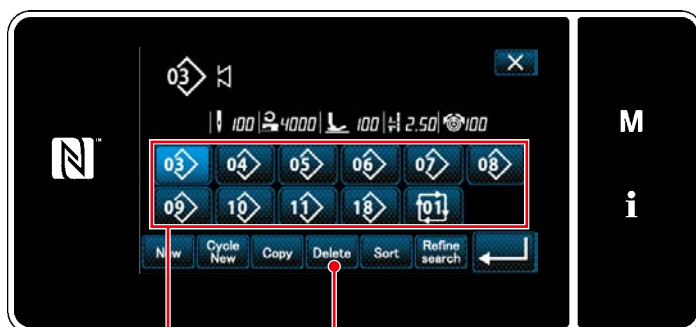

<Sewing pattern number list screen>

1. Select pattern number to delete from list ② .

2. Press  ③ .

The "deletion confirmation screen" is displayed.

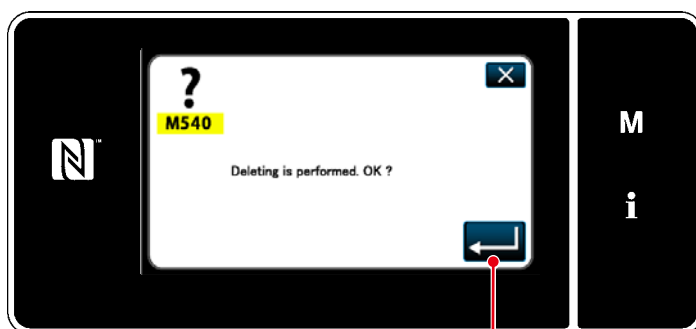

<Deletion confirmation screen>

3. The pattern is deleted by pressing  ④ .

8-2. Setting up the polygonal-shape stitching

A polygonal-shape stitching pattern consists of 20 steps (at the maximum) of constant-dimension sewing patterns. Specific sewing conditions can be set on a step-by-step basis.

*** This operation is to be carried out under the maintenance personnel mode.**

<Example of pattern>

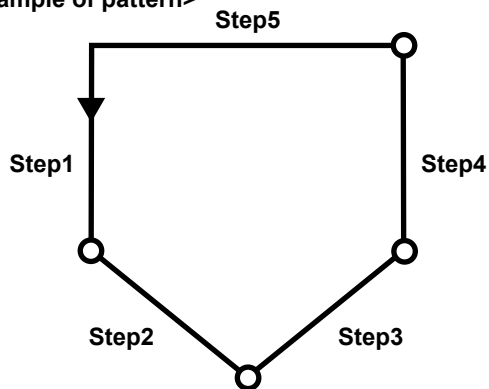

8-2-1. Editing a polygonal-shape stitching pattern

This section describes how to change the number of steps and step-by-step conditions of a polygonal-shape stitching pattern.

- ① **Displaying the sewing screen (maintenance personnel mode) for the polygonal-shape stitching pattern**

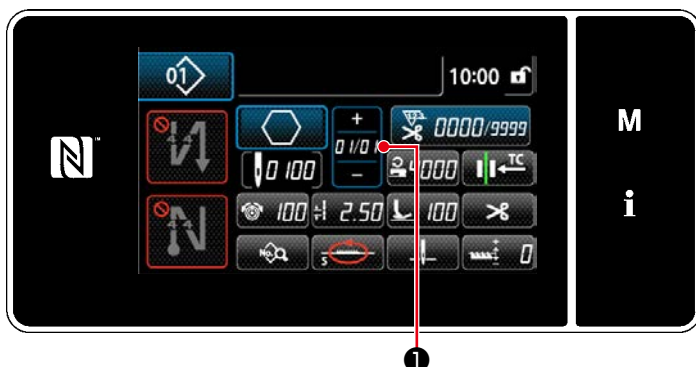

<Sewing screen (Maintenance personnel mode)>

Press  ① on the sewing screen under the maintenance personnel mode. The "polygonal-shape stitching step edit screen" is displayed.

② Editing the number of steps of a polygonal-shape stitching pattern and the number of stitches of a new pattern

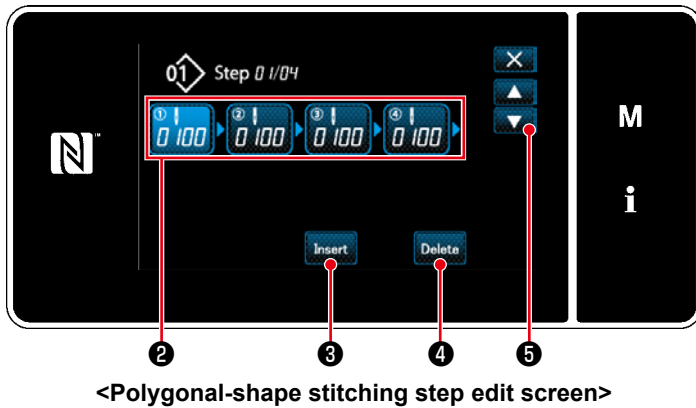

1. The number of stitches (0 to 2000) for a step is displayed in ② .

Press ② to place the number of stitches in the selected state.

The screen returns to the previous one or

advances to the next one with  ⑤ .

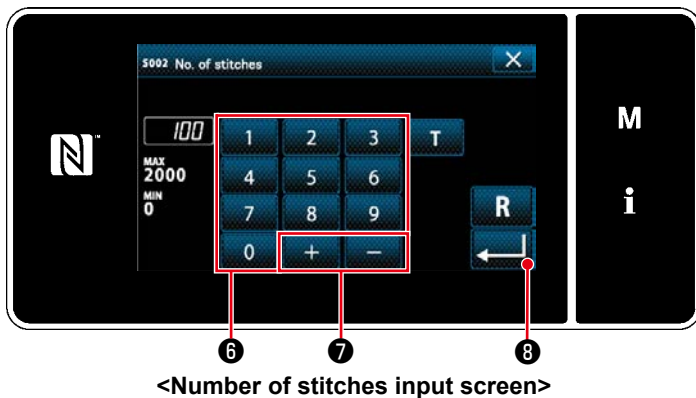

2. In the case a step(s) can be additionally registered in the pattern, a step consisting of zero (0) stitch is displayed at the tail end. "Number of stitches input screen" is displayed by pressing a step consisting of zero (0) stitch.

Enter the number of stitches for the step with numeric keypad ⑥ and

 ⑦ .

Press  ⑧ to confirm the setting.

3. A previous step and a step consisting of 100 stitches are inserted ahead of the selected step by pressing

 ③ .

"Number of stitches input screen" is displayed by pressing the inserted button.

Enter the number of stitches for the step with numeric keypad ⑥ and  ⑦ .

Press  ⑧ to confirm the setting.

Refer to "[4-2-8. Teaching function](#)" p.50 for the teaching function.

* In the case the maximum number of steps has already been registered,  ③ is not displayed.

4. The selected step is deleted by pressing  ④ .

* In the case only one step has been registered,  ④ is not displayed.

③ Confirming the data on the created sewing pattern

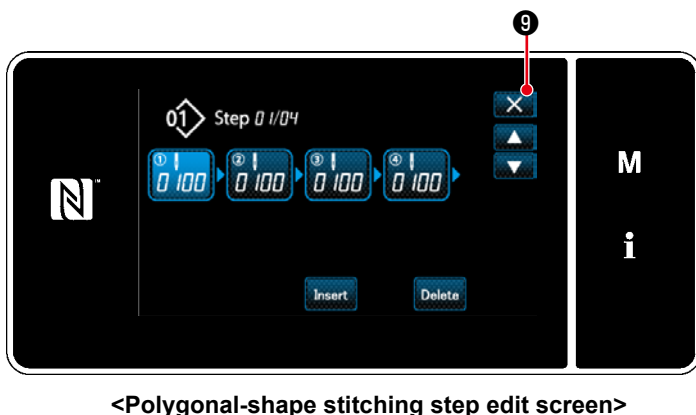

The operation is completed by pressing  ⑨ .

Then, the current screen returns to the sewing screen under the maintenance personnel mode.

8-2-2. Creating a new polygonal-shape stitching pattern

① Selecting the new-pattern creating function

Display the "new sewing pattern creation screen" referring to ① in **"8-1-1. Creation of a new pattern" p.101.**

② Setting the feed locus of polygonal-shape stitching

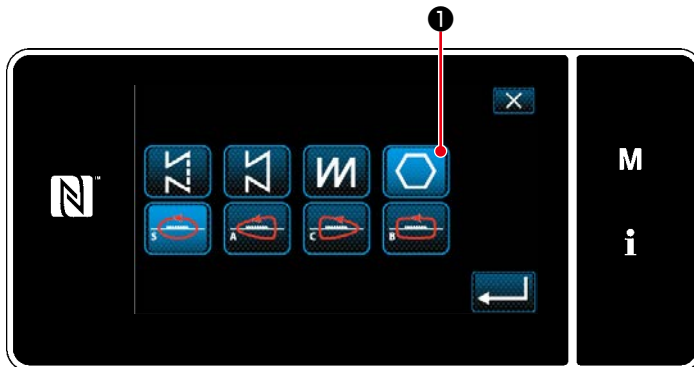

<New pattern creation screen>

Select the feed locus referring to ② in **"8-1-1. Creation of a new pattern" p.101.**

Select polygonal-shape stitch pattern



① on the stitch shape selection screen.

The "new sewing pattern edit screen" is displayed.

③ Setting the pattern function on a step-by-step basis

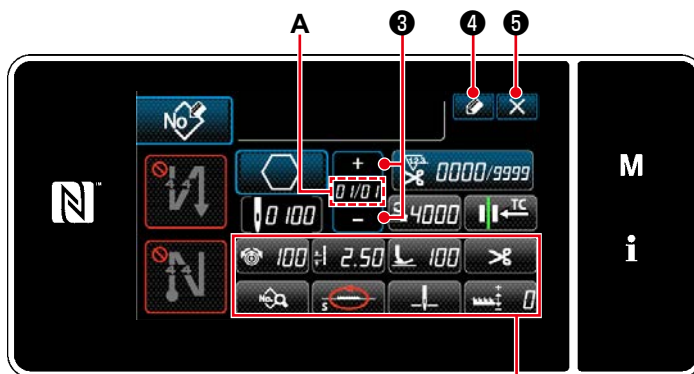

<New sewing pattern edit screen>

1. Set the pattern function with buttons ② on a step-by-step basis.

Refer to **"4-2. Sewing patterns" p.35.**

2. The total number of steps you have set is displayed on the right of section A. The current step is displayed on the left of section A. The

current step can be changed with



3. Press



The "sewing pattern number registration screen" is displayed.

Press



to display the data discard confirmation screen. Steps of procedure to be taken after the aforementioned step are same as steps ③ to ④ in **"8-1-1. Creation of a new pattern" p.101.**

8-2-3. Setting the step from which polygonal-shape stitching is started

In the case it is necessary to re-sew a pattern from the middle of the pattern after the occurrence of troubles such as thread breakage, it is possible to re-start sewing from an arbitrary step of the pattern.

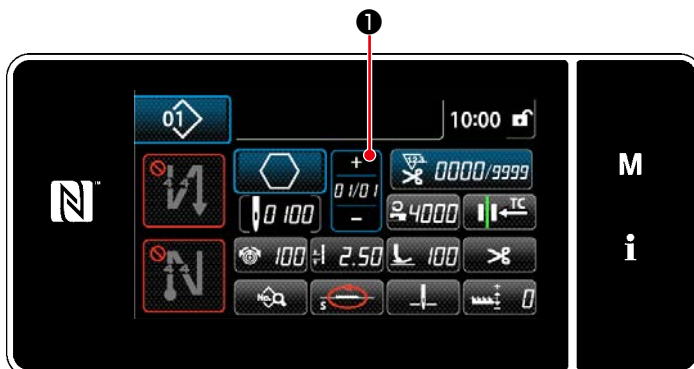

<Sewing screen (Polygonal-shape stitching pattern)>

The current step can be changed by pressing



① on the sewing screen for polygonal-shape stitching pattern.

8-3. Cycle pattern

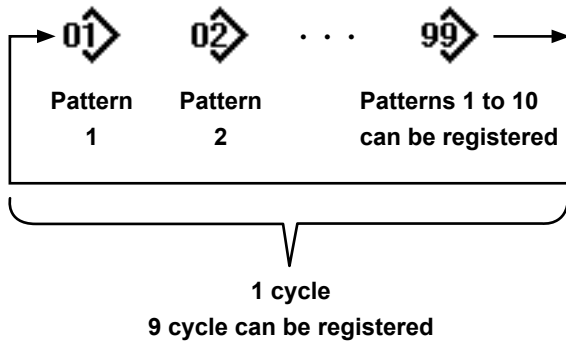

It is possible to combine several different sewing patterns as one cycle pattern for sewing.

As many as 10 patterns can be input in one cycle pattern. This function is helpful in the case several different patterns are regularly repeated in a product sewing process.

As many as 9 cycle patterns can be registered. Copy the cycle pattern when necessary.

8-3-1. Selecting the cycle pattern

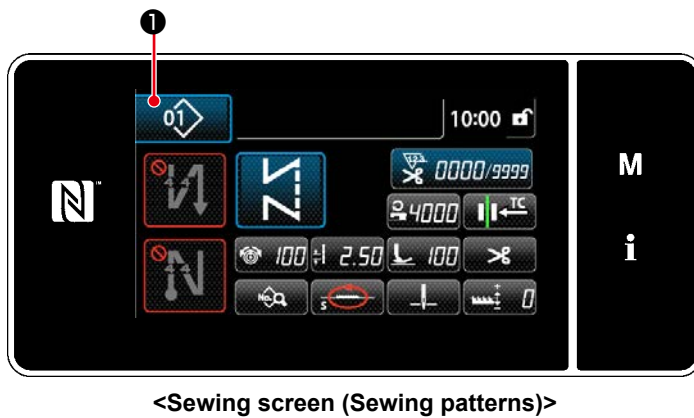

1. Press ① on each sewing screen.

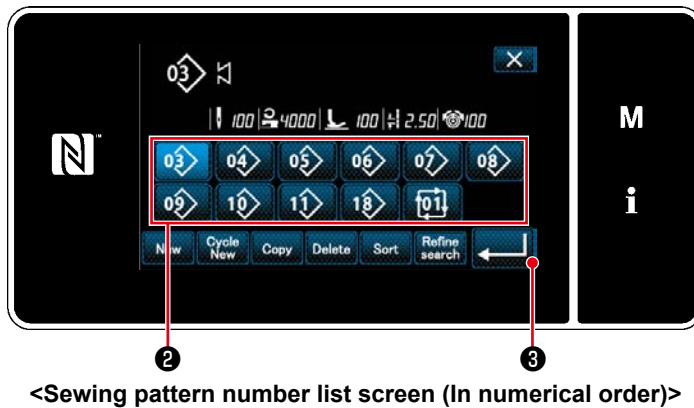

2. The "sewing pattern number list screen (In numerical order)" is displayed.

As many as 10 patterns can be entered in one cycle sewing pattern.

Cycle pattern(s) is displayed after the registered sewing patterns.

Press a desired cycle sewing data number button ② .

Press ③ to confirm the setting.

The "cycle sewing screen" is displayed.

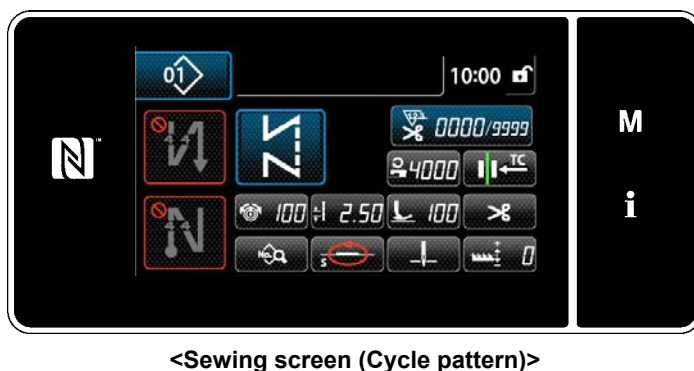

3. Sewing of the selected cycle pattern is enabled.

8-3-2. Editing cycle sewing data

① Displaying the sewing screen (cycle pattern) for cycle pattern

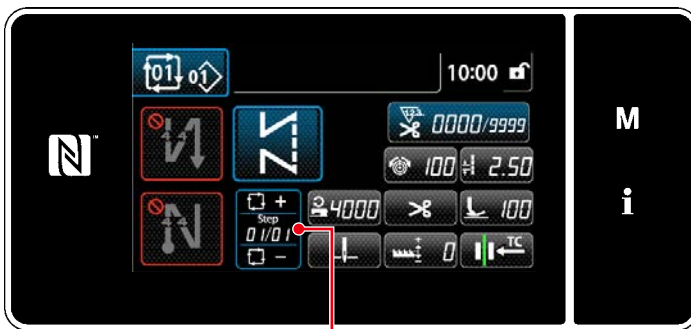

<Sewing screen (Cycle pattern)>

Keep  ① held pressed for one second on each sewing screen.

The "cycle sewing step edit screen" is displayed.

② Setting a cycle sewing pattern

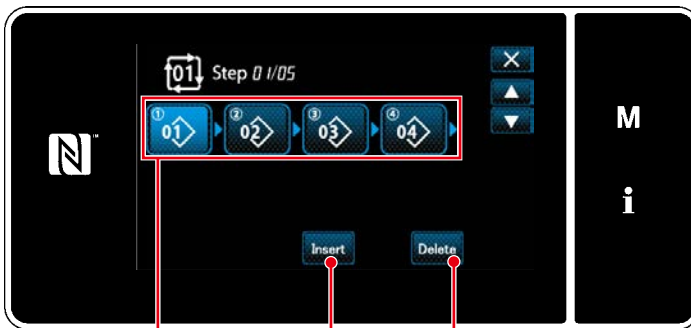

<Cycle sewing step edit screen>

1. Sewing pattern number (1 to 10) is displayed in ② .

Press ② to confirm the selection.

2. In the case a step(s) can be additionally registered in the pattern, a step consisting of zero (0) stitch is displayed at the tail end. "Registered cycle pattern selection screen (In numerical order)" is displayed by pressing a step consisting of zero (0) stitch.

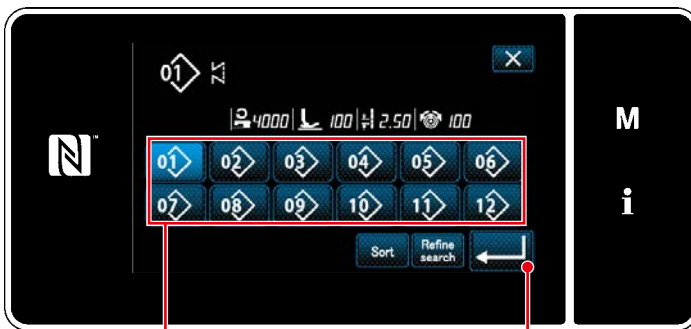

<Registered cycle pattern selection screen (In numerical order)>

3. Press  ⑤ .

Press  ⑥ to confirm the setting.

4. Press  ③ while selecting a step.

Then, the "registered cycle pattern selection screen (In numerical order)" is displayed. Insert a pattern ahead of the selected step.

5. The pattern is deleted by pressing  ④ .

③ Confirming the data entered

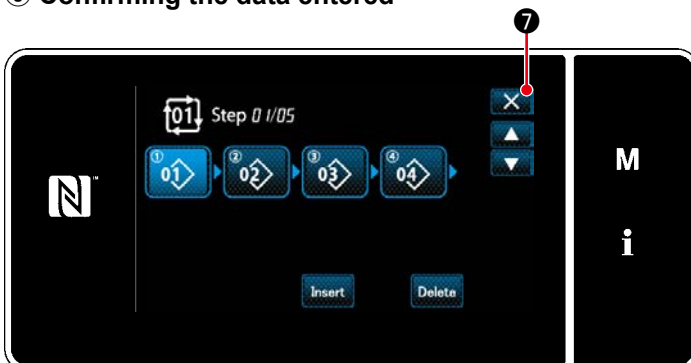

<Cycle sewing step edit screen>

Press  ⑦ to complete the operation.

Then, the current screen returns to the sewing screen for cycle sewing.

8-3-3. Creating a new cycle pattern

* This operation is to be carried out under the maintenance personnel mode.

① Selecting the new cycle pattern creating function



<Sewing screen (Maintenance personnel mode)>

1. Press **01** **1** on the sewing screen under the maintenance personnel mode. The "sewing pattern number list screen (In numerical order)" is displayed.

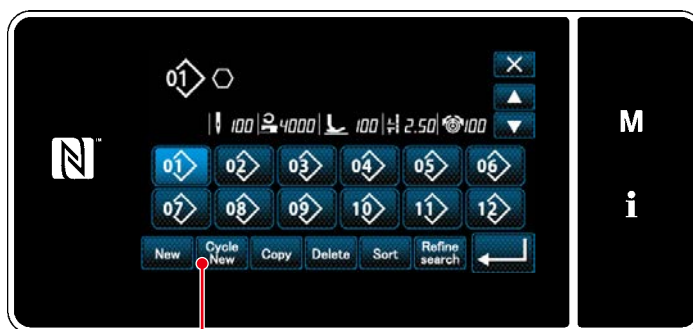

<Sewing pattern number list screen (In numerical order)>

2. Press **Cycle New** **2**. The "new cycle sewing pattern edit screen" is displayed.

② Registering a pattern in new cycle sewing data

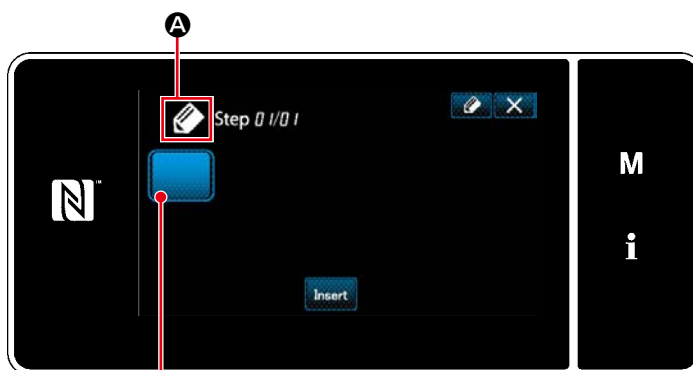

<New cycle sewing pattern edit screen>

1. **A** which indicates that a new pattern is being created is displayed on the screen.
2. Press **3**. The "registered cycle pattern selection screen (In numerical order)" is displayed.

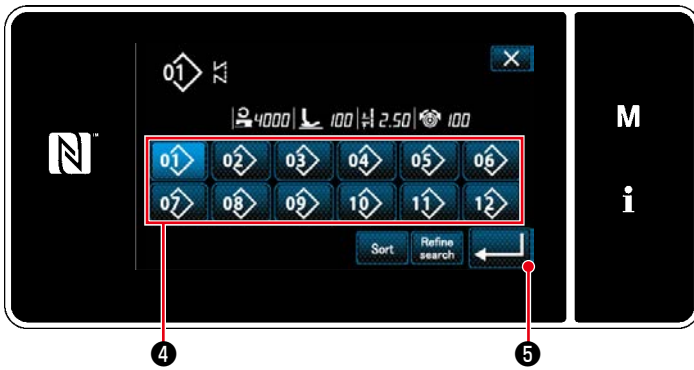

<Registered cycle pattern selection screen
(In numerical order)>

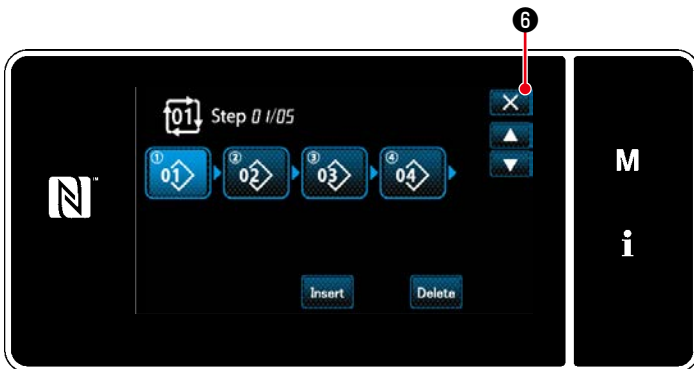

<Cycle sewing step edit screen>

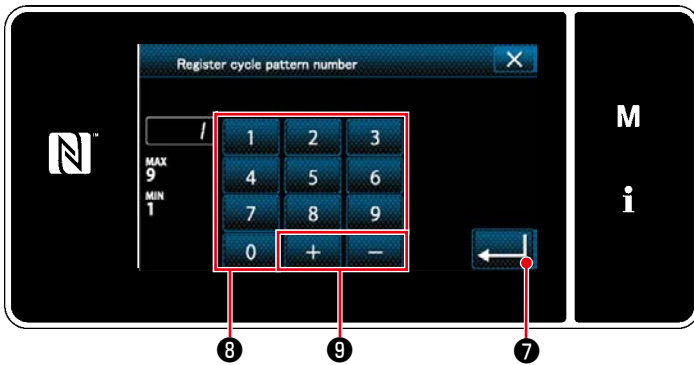

<Cycle sewing pattern number registration screen>

3. Display a desired pattern number referring to **"4-2-2. List of sewing patterns" p.36.**

Press  ④ .

4. Press  ⑤ to confirm the setting.

The current screen returns to the "new cycle sewing step edit screen".

5. The selected pattern is added to cycle sewing data with  suffixed.

Create the cycle sewing data by repeating steps 2 to 5.

6. Press  ⑥ to display the data discard confirmation screen.

7. Enter the sewing pattern number to be registered using numeric keypad ⑧ .

An unassigned registration number that is closest to the entered value in the plus/minus direction is displayed by pressing

  ⑨ .

8. The created pattern is registered by pressing  ⑦ .

Then, the current screen returns to the "sewing pattern number list screen". In the case the entered number has already been registered, the prompt message for overwrite confirmation is displayed.

8-3-4. Setting the step from which cycle sewing pattern is started

In the case it is necessary to re-sew a cycle sewing pattern from the middle of the cycle sewing pattern after the occurrence of troubles such as thread breakage, it is possible to re-start sewing from an arbitrary step of the cycle sewing pattern.

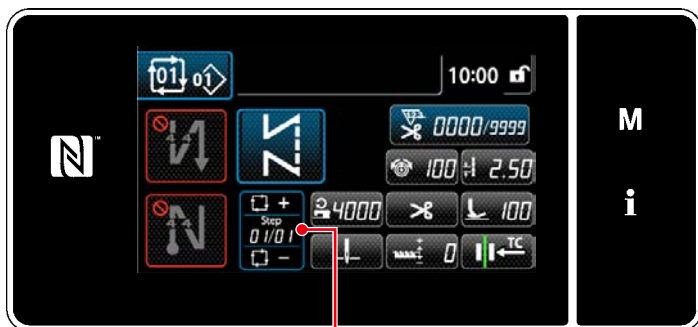

Sewing step can be selected with +/- key of



<Sewing screen (Cycle patterns)>

8-4. Custom pitch

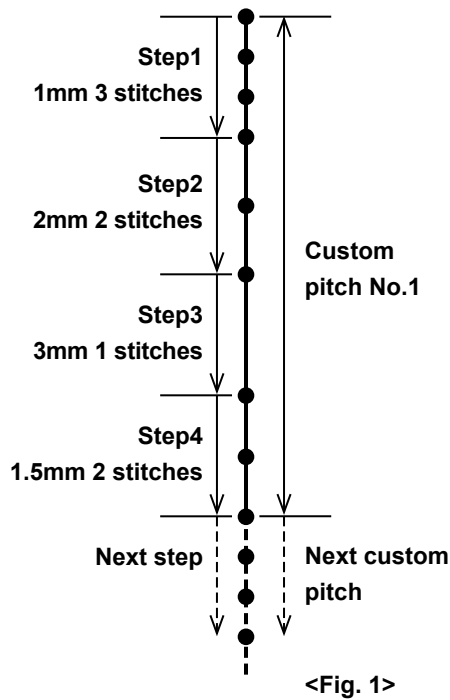

It is possible to register as many as 20 different sewing designs each of which consists of several different pitches (10 steps at the maximum).

As many as 100 stitches of the same pitch can be set in one step.

*** This operation is to be carried out under the maintenance personnel mode.**

- Caution**

 1. Desired stitches may not be formed depending on the sewing speed. If desired stitches are not produced, the sewing speed should be reduced.
 2. In the case the pitch is 0.00 mm, it is not possible for the needle to enter the same needle entry point.

8-4-1. Selecting a custom pitch

Select an already-created custom pitch.

Custom pitch can be used for pattern sewing, reverse-feed stitching at the beginning of sewing and reverse-feed stitching at the end of sewing. In this section, application of a custom pitch to a sewing pattern is described as an example.

① Displaying the pitch input screen

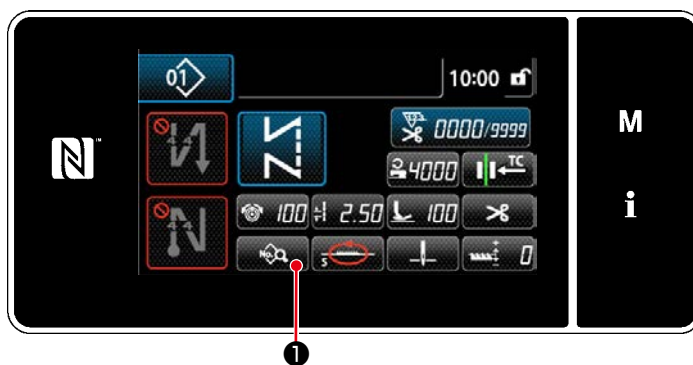

<Sewing screen (Maintenance personnel mode)>

1. Press  ① on the sewing screen under the maintenance personnel mode. The "sewing data edit screen" is displayed.

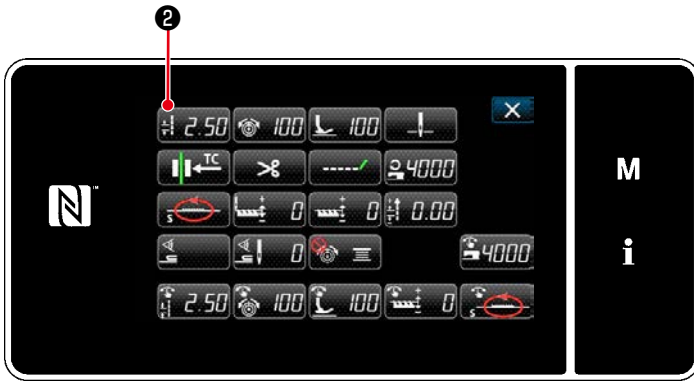

<Sewing data edit screen>

2. Press 2.50 ② .

The "pitch input screen" is displayed.

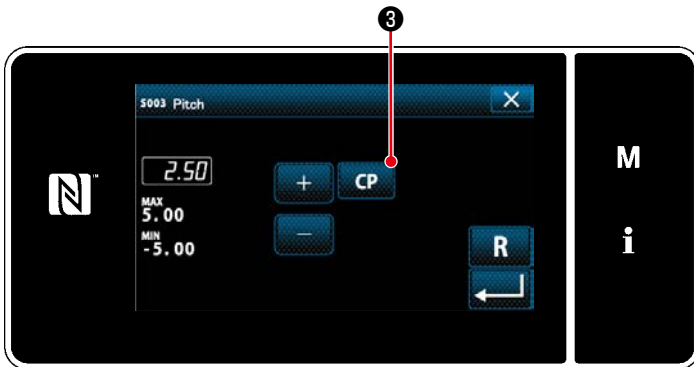

<Pitch input screen>

3. In the case a custom pitch pattern(s) has been registered, ③ is displayed.

Press ③ .

The "custom pitch setting screen" is displayed.

② Selecting a custom pitch

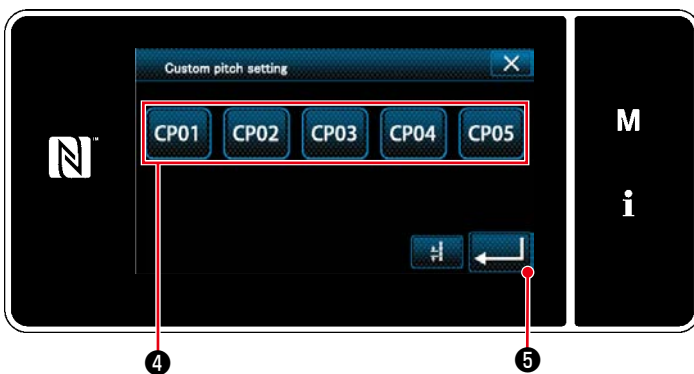

<Custom pitch setting screen>

Registered custom pitch pattern(s) is displayed.

Press ④ .

Press ⑤ to confirm the setting.

Return the current screen to the sewing screen (maintenance personnel mode).

8-4-2. Creating a new custom pitch

Create the new custom pitch No. 1 shown in <Fig. 1> as an example.

① Selecting the custom pitch setting on the mode screen



<Mode screen>

1. Press **M** ①.

The "mode screen" is displayed.

2. Select the "5. Custom pitch setting".

The "custom pitch list screen" is displayed.

② Selecting the new custom pitch creating function

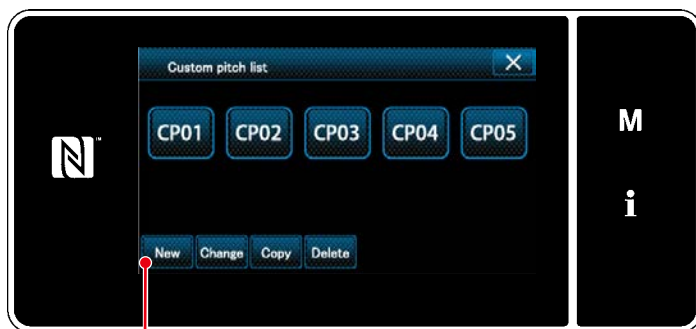

<Custom pitch list screen>

Registered custom pitch pattern(s) is displayed.

Press **New** ②.

The "new custom pitch pattern creation number input screen" is displayed.

③ Inputting a custom pitch pattern number

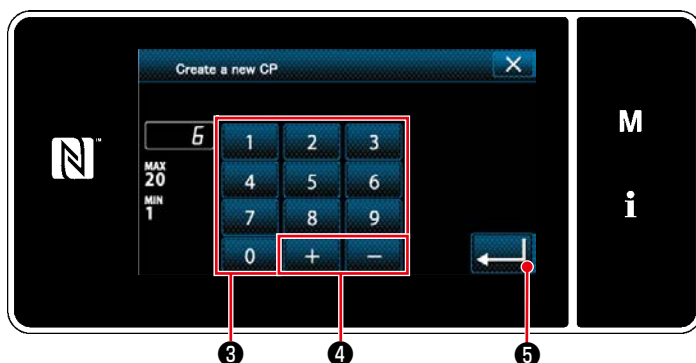

<New custom pitch pattern creation number input screen>

1. Enter the pattern number with numeric keypad ③.

An unassigned registration number that is closest to the entered value in the plus/minus direction is displayed by pressing

+ **-** ④.

2. Press **←** ⑤.



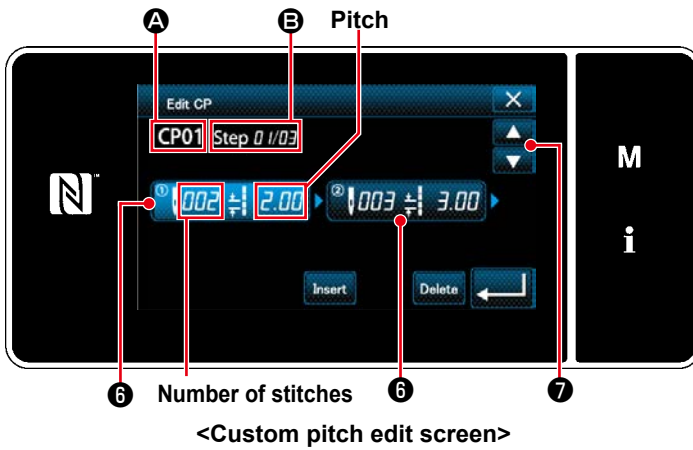

The "custom pitch edit screen" is displayed. In the case the entered number has already been registered, the prompt message for overwrite confirmation is displayed.

④ Creating a custom pitch

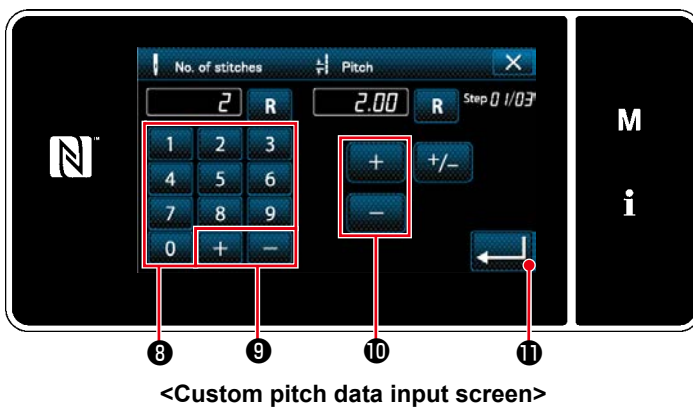

1. Press **6** to put the step you have pressed in the selected state.
 2. The selected custom pitch number is displayed in **A**, and the step number which is being edited and the total number of steps are displayed in **B**.
 3. The "number of stitches" and "pitch" for the step are displayed in **6**. Press **6** to put the displayed data in the selected state.
- Press  **7** to display the screen of the previous custom pitch number or of the next custom pitch number.
4. "Custom pitch data input screen" is displayed by pressing **6** while the step is being selected.



- 1) In the case of setting the number of stitches
As an example, explanation is given about the input procedure of custom pitch number 1 shown in <Fig. 1>.
The number of stitches can be input in the range from 1 to 100.
Set the number of stitches for step 1 to 3 with numeric keypad **8** for the number of stitches and  **9**.
- Press  **11** to confirm the setting.
- 2) In the case of setting the pitch
The pitch can be input in the range from -5.00 to 5.00 mm.
Set the pitch for step 1 to 1.00 with  **10** for pitch.
- Press  **11** to confirm the setting.
- 3) Carry out the following setting in the similar manner.
For step 2, set the number of stitches to 2, and the pitch to 2.00 mm.
For step 3, set the number of stitches to 1, and the pitch to 3.00 mm.
For step 4, set the number of stitches to 2, and the pitch to 1.50 mm.

⑤ Confirming the numeric value



After the completion of editing, press  ⑫.

<Custom pitch edit screen>



The custom pitch list screen is displayed with the custom pitch number you have created added.

<Custom pitch list screen>

8-4-3. Custom pitch edit function

① Selecting the custom pitch edit function



<Custom pitch edit screen>

Display the "custom pitch edit screen" referring to ["8-4-2. Creating a new custom pitch" p.115.](#)

② Editing the custom pitch value

In this section, procedure for editing the custom pitch value is described.

Refer to ["8-4-2. Creating a new custom pitch" p.115](#) for the explanation of screen.

1) In the case of setting the number of stitches

The number of stitches can be input in the range from 1 to 100.

Change the number of stitches for step 1 to 2 with the numeric keypad for the number of stitches and



Press  to confirm the setting.

2) In the case of setting the pitch

The pitch can be input in the range from -5.00 to 5.00 mm.

Change the pitches for step 1 to 2.00 with .

Press  to confirm the setting.

3) Carry out the following setting in the similar manner.

The number of stitches of step 2 : From 2 to 3 stitches; Pitch : From 2.00 to 1.00 mm

The number of stitches of step 3 : From 1 to 2 stitches; Pitch : From 3.00 to 2.00 mm

The number of stitches of step 4 : 0 stitches (None); Pitch : 0 mm (None)

Steps of procedure to be taken after the aforementioned step are same as those described in ["8-4-2. Creating a new custom pitch" p.115.](#)

8-4-4. Copying/deleting a custom pitch

(1) Copying a custom pitch

① Displaying the custom pitch list screen

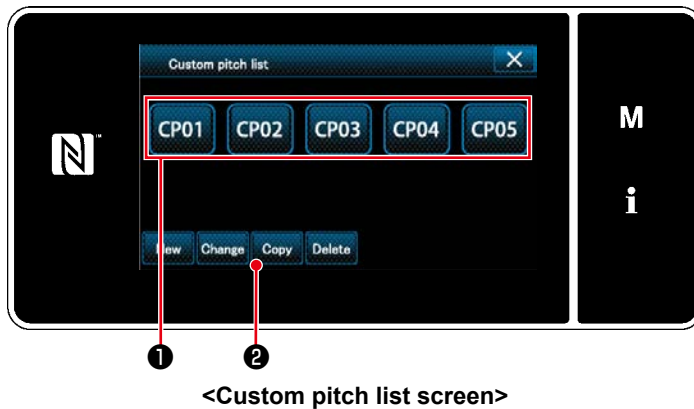

1. Display the "custom pitch list screen" referring to ["8-4-2. Creating a new custom pitch" p.115](#).

2. Press **CP01** ① of the copy source to put it in the selected state.

3. Press **Copy** ② .

The "custom pitch copy destination number input screen" is displayed.

② Inputting the custom pitch number

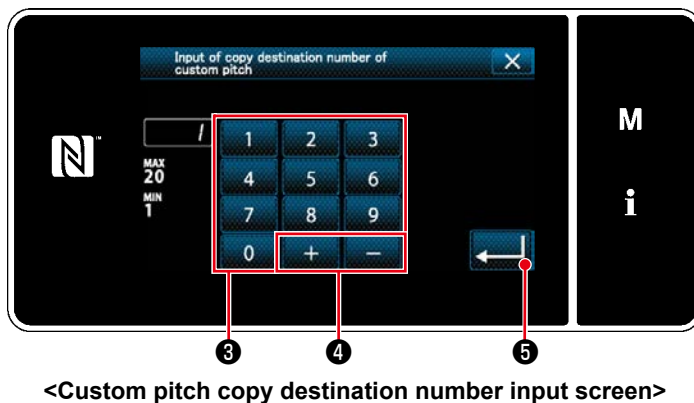

Enter the number of destination pattern for copying with numeric keypad ③ and

+ **-** ④ .

Press **←** ⑤ .

The created pattern is registered, and the current screen is returned to the custom pitch screen.

In the case the entered number has already been registered, the prompt message for overwrite confirmation is displayed.

(2) Deleting a custom pitch

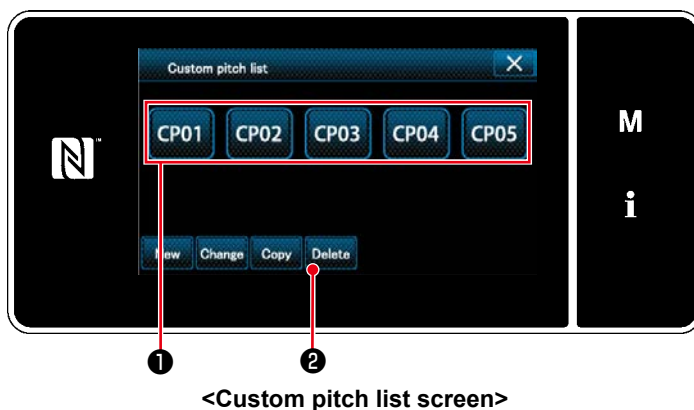

1. Display the "custom pitch list screen" referring to ["8-4-2. Creating a new custom pitch" p.115](#).

2. Press **CP01** ① to put the custom pitch to be deleted in the selected state.

3. Press **Delete** ② .

The "deletion confirmation screen" is displayed.

Press **←** to confirm the setting.

8-5. Condensation custom pattern

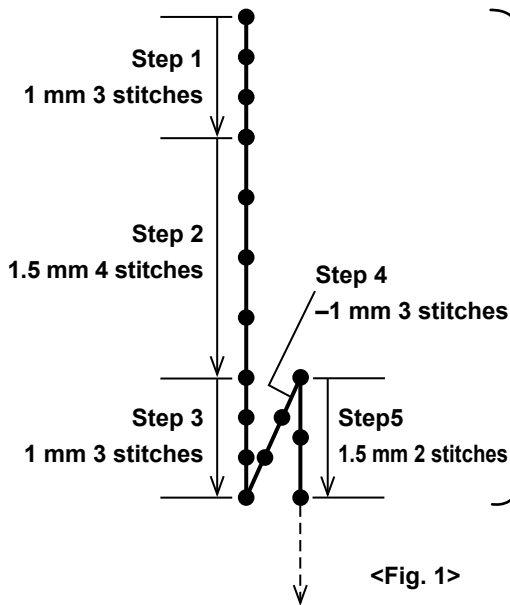

Condensation stitches can be sewn while specifying needle entry points as desired, by setting a condensation custom. As many as 20 steps can be created in one condensation custom pattern. For each step, as many as nine different patterns of start and end of sewing can be registered.

Condensation custom No. 1



1. Desired stitches may not be formed depending on the sewing speed. If desired stitches are not produced, the sewing speed should be reduced.
2. In the case the pitch is 0.00 mm, it is not possible for the needle to enter the same needle entry point.

8-5-1. Selecting the condensation custom

Select condensation custom pattern referring to "4-2-3.(2) ◆ For the maintenance personnel mode" p.40.

The condensation custom pattern for reverse-feed stitching at the end of sewing can be set in the similar manner.

8-5-2. Creating a new condensation custom

Create the new condensation custom No. 1 shown in <Fig. 1> as an example.

① Selecting the condensation custom pattern setting on the mode screen

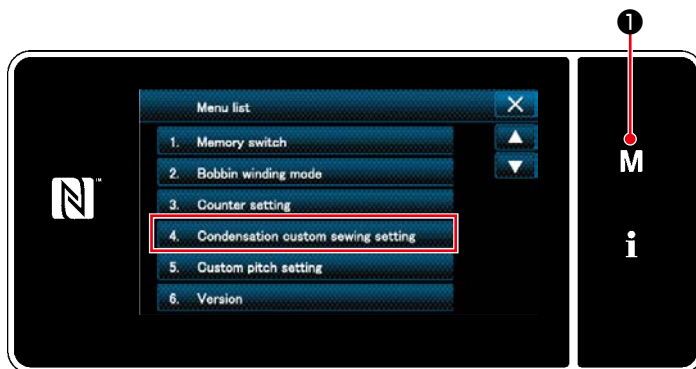

<Mode screen>

1. Press **M** ①.

The "mode screen" is displayed.

2. Select the "4. Condensation custom sewing setting".

The "condensation custom pattern list screen" is displayed.

② Selecting the new condensation custom creating function



<Condensation custom pattern list screen>

Registered condensation custom patterns are displayed on the screen.

Press **New** ②.

The "new condensation custom pattern creation pattern number input screen" is displayed.

③ Inputting the condensation custom number

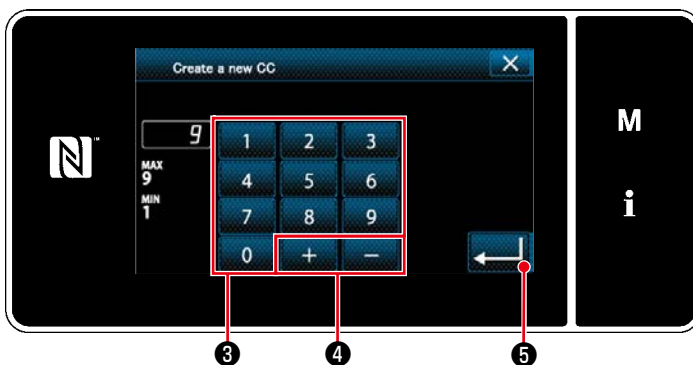

<New condensation custom pattern creation pattern number input screen>

1. Enter the number of destination pattern for copying with numeric keypad ③.

An unassigned registration number that is closest to the entered value in the plus/minus direction is displayed by pressing



2. Press **Enter** ⑤.

The "condensation custom edit screen" is displayed.

In the case the entered number has already been registered, the prompt message for overwrite confirmation is displayed.

④ Creating a condensation custom

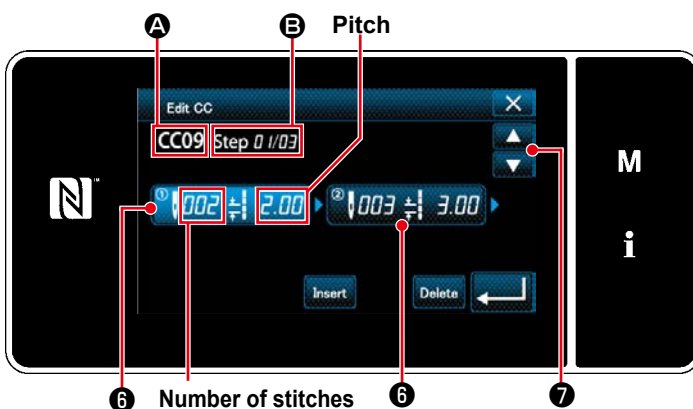

<Condensation custom edit screen>

1. Press **Enter** ⑥ to put the step you have pressed in the selected state.

2. The selected condensation custom number is displayed in **A** and the step number which is being edited, and the total number of steps are displayed in **B**.

3. The "number of stitches" and "pitch" for the step are displayed in **6**. Press **Enter** ⑥ to put the displayed data in the selected state.

Previous step number screen or the next step number screen is displayed with  ⑦.

4. "Condensation custom data input screen" is displayed by pressing **Enter** ⑥ while the step is being selected.

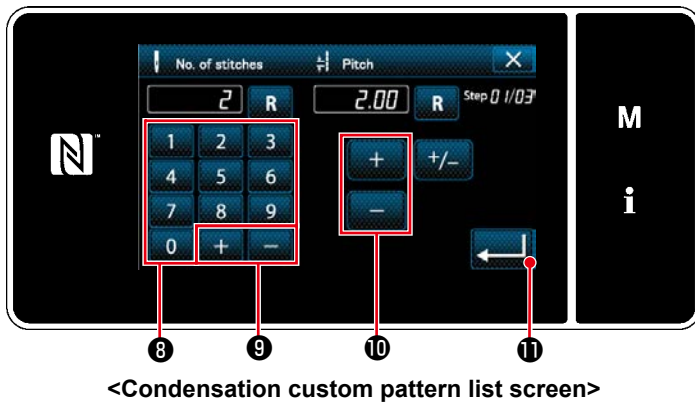

1) In the case of setting the number of stitches

As an example, explanation is given about the input procedure of condensation custom number 1 shown in <Fig. 1>.

The number of stitches can be input in the range from 1 to 100.

Set the number of stitches for step 1 to 3 with numeric keypad **8** for the number of stitches and **+** **-** **9** .

A negative number of stitches can also be set. In this case, the direction of feed is reverse direction.

Press **↵** **11** to confirm the setting.

2) In the case of setting the pitch

The pitch can be input in the range from -5.00 to 5.00 mm.

Set the pitch for step 1 to 1.00 with **+** **-** **10** for pitch.

Press **↵** **11** to confirm the setting.

3) Carry out the following setting in the similar manner.

For step 2, set the number of stitches to 4, and the pitch to 1.50 mm.

For step 3, set the number of stitches to 3, and the pitch to 1.00 mm.

For step 4, set the number of stitches to 3, and the pitch to -1.00 mm.

For step5, set the number of stitches to 2, and the pitch to 1.50 mm.

⑤ Confirming the numeric value



Press **↵** **12** to confirm the setting.



The condensation custom list screen is displayed with the condensation custom number you have created added.

8-5-3. Condensation custom edit function

① Selecting the condensation custom edit function



<Condensation custom edit screen>

Display the "condensation custom edit screen" referring to ["8-5-2. Creating a new condensation custom" p.120.](#)

② Editing the condensation custom value

In this section, procedure for editing the condensation custom value is described.

Refer to ["8-5-2. Creating a new condensation custom" p.120](#) for the explanation of screen.

1) In the case of setting the number of stitches

The number of stitches can be input in the range from 1 to 100.

Change the number of stitches for step 1 from 3 to 5 with the numeric keypad for the number of stitches and .

Press  to confirm the setting.

* A negative number of stitches can also be set. In this case, the direction of feed is reverse direction.

2) In the case of setting the pitch

The pitch can be input in the range from -5.00 to 5.00 mm.

Change the pitches for step 1 from 1.00 to 0.500 with .

Press  to confirm the setting.

3) Carry out the following setting in the similar manner.

The number of stitches of step 2 : From 4 to 2 stitches; Pitch : From 1.50 to 2.00 mm

The number of stitches of step 3 : From 3 to 5 stitches; Pitch : From 1.00 to 0.5.00 mm

The number of stitches of step 4 : From 3 to 5 stitches; Pitch : From -1.00 to -0.80 mm

The number of stitches of step 5 : 0 stitches (None); Pitch : 0 mm (None)

Steps of procedure to be taken after the aforementioned step are same as those described in ["8-5-2. Creating a new condensation custom" p.120.](#)

8-5-4. Copying/deleting a condensation custom

(1) Copying a condensation custom

① Displaying the condensation custom pattern list screen



<Condensation custom pattern list screen>

1. Display the "condensation custom pattern list screen" referring to ["8-5-2. Creating a new condensation custom" p.120](#).
2. Press **CC01** ① of the copy source to put it in the selected state.
3. Press **Copy** ②.

The "condensation custom copy destination number input screen" is displayed.

② Inputting the condensation custom pattern number

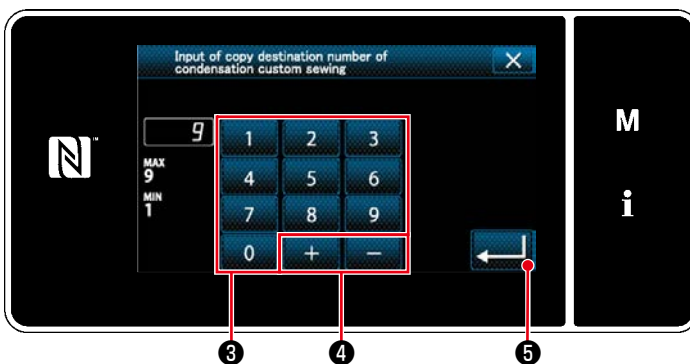

<Condensation-custom pattern copy destination number input screen>

1. Enter the number of destination pattern for copying with numeric keypad ③ and **+** **-** ④.
2. Press **←** ⑤.

The created condensation custom pattern is registered. Then, the current screen is returned to the sewing screen.

In the case the entered number has already been registered, the prompt message for overwrite confirmation is displayed.

(2) Deleting a condensation custom

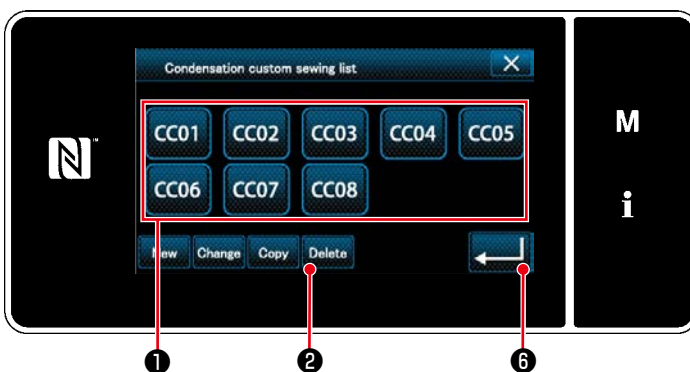

<Condensation custom pattern list screen>

1. Display the "condensation custom pattern list screen" referring to ["8-5-2. Creating a new condensation custom" p.120](#).
2. Press **CC01** ① to put the custom pitch to be deleted in the selected state.
3. Press **Delete** ②.

The "deletion confirmation screen" is displayed.

Press **←** ⑥ to confirm the setting.

8-6. Simple lock of the screen

Once the simple lock is enabled, operation of the buttons displayed on the screen is disabled, thereby preventing maloperation.

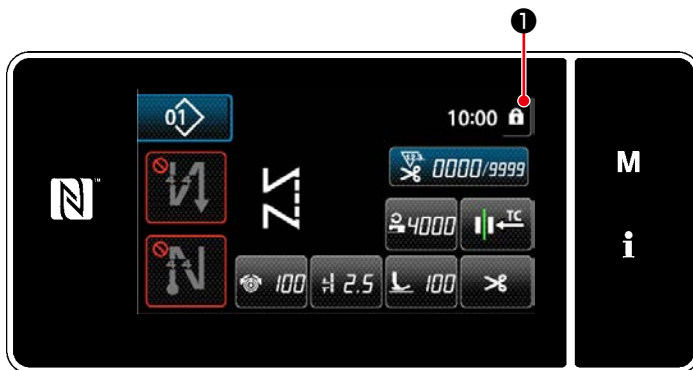

<Sewing screen>

Simple lock is activated by keeping  ① held pressed for one second on the sewing screen.

Pictograph display ① will be as shown below:

 : Simple lock is enabled

 : Simple lock is disabled

* In the shipped state, simple lock of the operation panel is enabled automatically if no operation is carried out for one minutes.

* The time to be elapsed until the simple lock is enabled can be set with the memory switch U402.

Refer to "[8-3-4. Setting the step from which cycle sewing pattern is started](#)" p.112 for details.

8-7. Version information

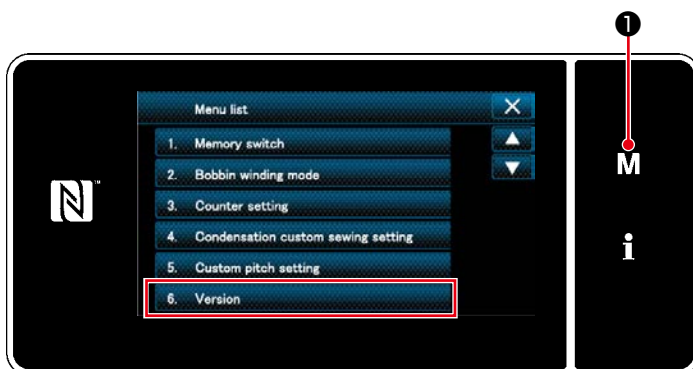

<Mode screen>

1. Press  ①.

The "mode screen" is displayed.

2. Select the "6. Version".

The "version information screen" is displayed.



<Version information screen>

3. The screen returns to the previous screen by pressing  ②.

8-8. Adjustment of brightness of the LED panel

Screen brightness of the LED panel can be changed.

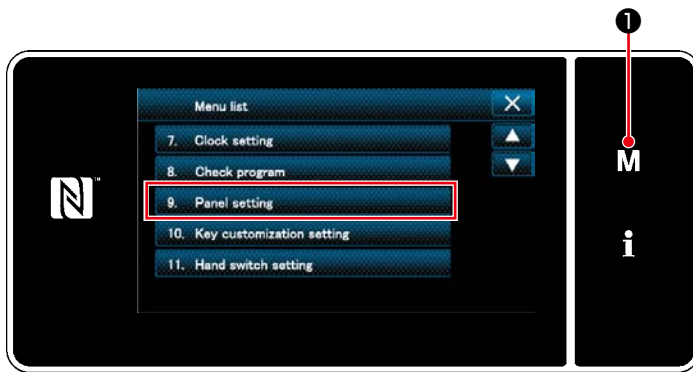

<Mode screen>

1. Press **M** ①.

The "mode screen" is displayed.

2. Select the "9. Panel setting".

The "operation panel setting screen" is displayed.

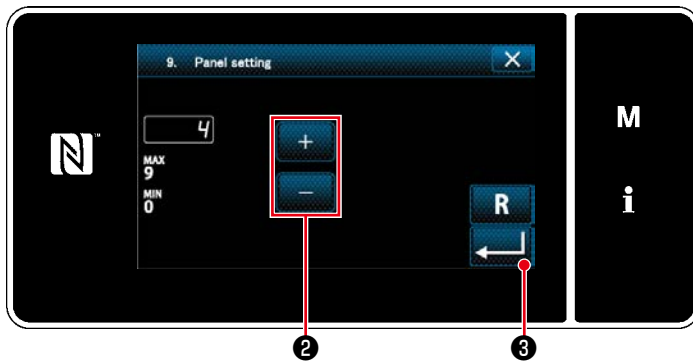

<Operation panel setting screen>

3. Brightness of the operation panel is adjustable with

able with  ②.

4. Press  ③ to confirm the setting.

Return the "mode screen".

8-9. Information



Press **i** ①.

The "information screen" is displayed.

<Information screen>

Data communication and production management are carried out on the information screen.

8-9-1. Data communication

Data can be input/output by means of a USB thumb drive.

Data that can be handled on the information screen is as follows:

Data name	Extension	Description of data
Sewing data	DDL00XXX.EPD (XXX:001~999)	Data format of sewing shapes and number of stitches created on the sewing machine. This format is specific to the DDL-9000C.
Custom pitch data	VD00XXX.VDT (XXX:001~999)	It is the data of needle entry point created with PM-1, and the data format that can be operated in common between JUKI sewing machines.
Condensation custom data	VD00XXX.VDT (XXX:001~999)	It is the data of needle entry point created with PM-1, and the data format that can be operated in common between JUKI sewing machines.

(1) Communication method

① Selecting the data format used for communication



<Information screen>

1. Select "1. Data communication" on the "information screen".

The "data communication list screen" is displayed.



<Data communication list screen>

2. Select the transmitting/receiving data format and press the selected data format button.

For example, select "1. EPD data transmission/reception".

The "data direction selection screen" is displayed.

② Selecting the communication direction

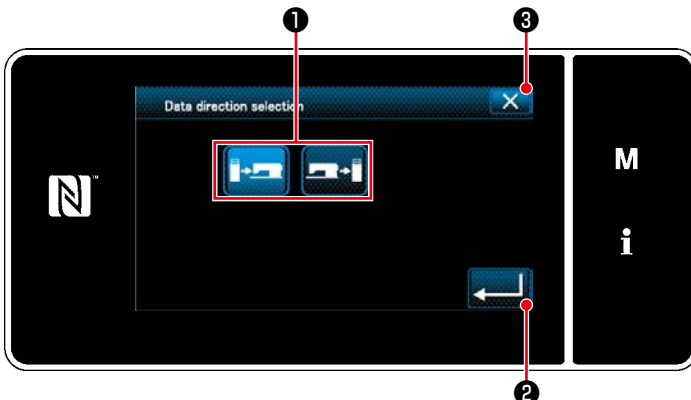

<Data direction selection screen>

Select the communication direction. Press button ① to put the communication direction in the selected state.

Press  ② to confirm the setting.

The "data transmission/receipt preparation screen" is displayed.

Cancel the operation with  ③. The current screen returns to the previous screen.

③ Setting the data number and starting communication

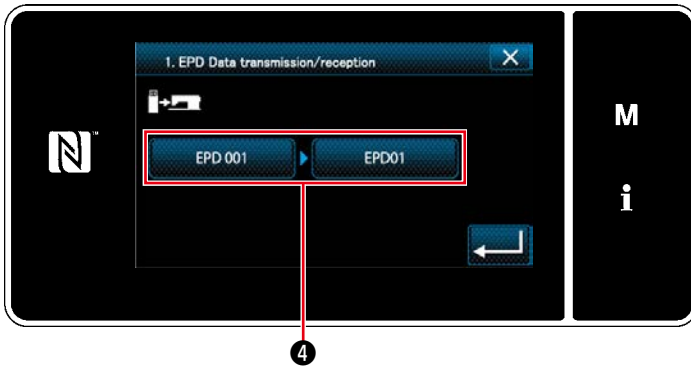

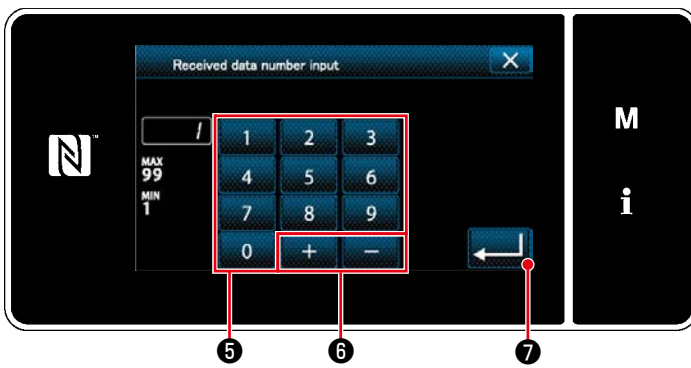

<Data transmission/receipt preparation screen>

1. Press data number button ④ .
The "data number input screen" is displayed.



<Data number input screen>

2. Enter the source/destination data number with numeric keypad ⑤ and   ⑥ .

Press  ⑦ to confirm the setting.

The "data transmission/receipt preparation screen" is displayed.

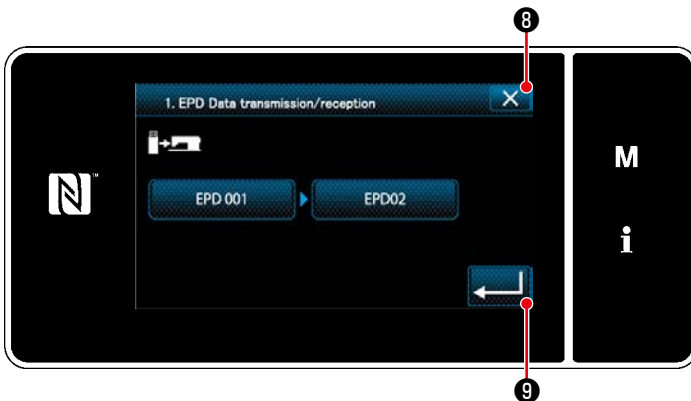

<Data transmission/receipt preparation screen>

3. Confirm the numeric value with  ⑨ to start communication.

"During communication" screen is displayed while the communication is being carried out.

Cancel the operation with  ⑧ . The current screen returns to the previous screen.

* If the destination number you have entered has already been registered, the "overwrite confirmation message" screen will be displayed.

8-9-2. USB

(1) About the USB

Sewing data, custom pitch data and condensation custom data can be copied on a commercially-available USB thumb drive.

Refer to "**8-9-1. Data communication**" p.127 for details of how to copy the sewing data on a USB thumb drive.

① Position of the USB connector

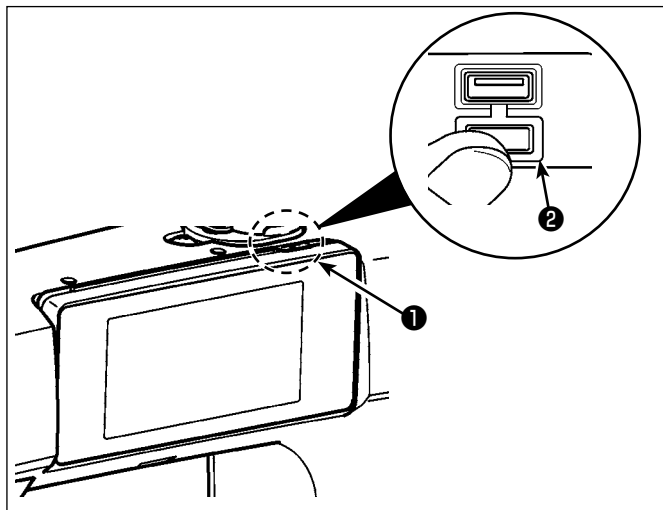

[USB thumb drive insertion position]

The USB connector is provided on top ① of the operation panel.

To use a USB thumb drive, remove connector cover ② and insert the USB thumb drive into the USB connector.

- * In the case a USB thumb drive is not used, the USB connector should be protected with connector cover ② without exceptions. If dust or the like enters the USB connector, a failure can be caused.

② Precautions to be taken when handling USB devices

- Do not connect to the USB connection terminal other than the USB memory. It may cause failure.
- Do not leave the USB device or USB cable connected to the USB port while the sewing machine is in operation. The machine vibration can damage the port section resulting in loss of data stored on the USB device or breakage of the USB device or sewing machine.
- Do not insert/remove a USB device during reading a program or sewing data. It may cause data breakage or malfunction.
- When the storage space of a USB device is partitioned, only one partition is accessible.
- Never forcefully insert a USB thumb drive into the USB connector while carefully checking the orientation of the USB thumb drive. Forceful insertion of the USB thumb drive can cause failure.
- JUKI does not compensate for loss of data stored on the USB device caused by using it with this sewing machine.
- In principle, connect only one USB thumb drive to the operation panel. When two or more devices/media are connected/inserted, the machine will only recognize one of them. Refer to the USB specifications.
- Do not turn the power OFF while the data on the USB flash drive is being accessed.

③ USB specifications

- Conform to USB 1.1 standard
- Applicable devices *1 _____ USB memory
- Format supported _____ FAT 12, FAT 16, FAT 32
- Applicable medium size _____ 4.1MB ~ (2TB)
- Consumption current _____ The rated consumption current of the applicable USB devices is 500 mA at the maximum.

*1: JUKI does not guarantee operation of all applicable devices. Some device may not operate due to a compatibility problem.

8-9-3. Production management

The production management function enables editing of ID assigned to each operator and setting of irregular work time.

The operator ID is displayed on each sewing machine and recorded together with the operator's movement information. As a result, production state of each operator can be managed.

* Contact your distributor about connection between the sewing machine and IA-1.

(1) Setting the operator ID

① Selecting the operator ID setting function

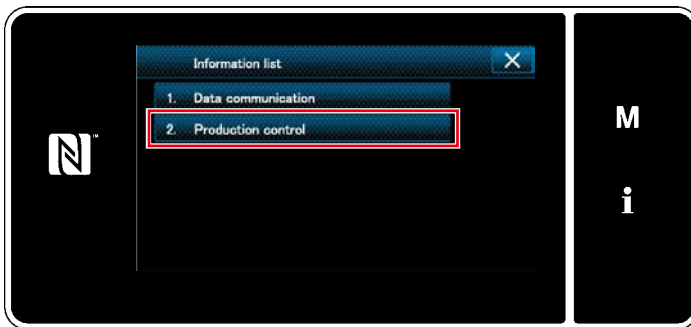

<Information screen>

1. Select "2. Production control" on the "information screen".

The "production management screen" is displayed.



<Production management screen>

2. Select the "1. Operator ID setting".

The "operator ID edit screen" is displayed.

② Editing the operator ID

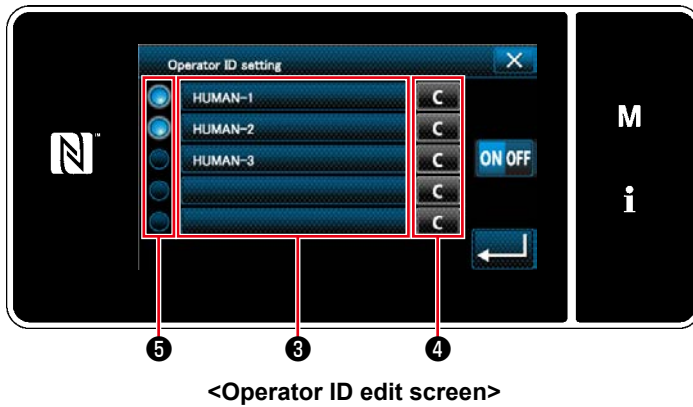

Press ③ .

The "operator ID input screen" is displayed.
The entered operator ID is cleared by pressing



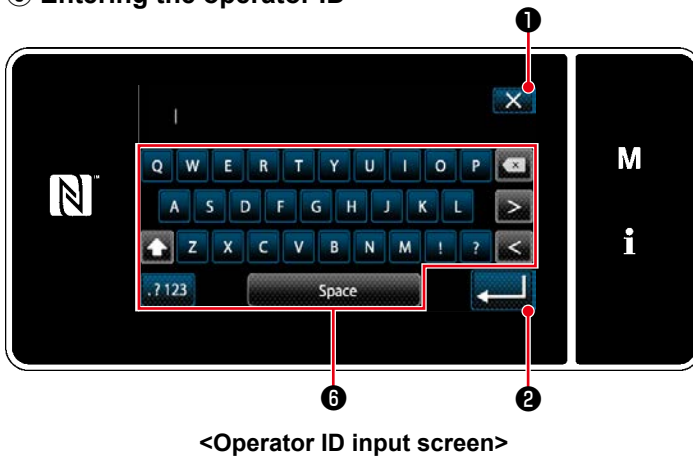

④ .
Enable/disable of each operator ID can be selected by pressing ⑤ .

③ Entering the operator ID



1. The operator ID can be entered with the character string button ⑥ .

Cancel the operation with  ① . The current screen returns to the previous screen.

Press  ② to confirm the setting.
The "operator ID edit screen" is displayed.



2. Use/non-use of the ID can be selected with



 (Use) → The operator ID function is used. The operator ID is displayed on the operator and the operator's movement information is recorded.

 (Non-use) → The operator ID function is not used.

* This function is enabled only in the case of IA-1 is connected to the sewing machine.

* Contact your distributor about connection between the sewing machine and IA-1.

(2) Setting the irregular work

① Selecting the irregular work setting function

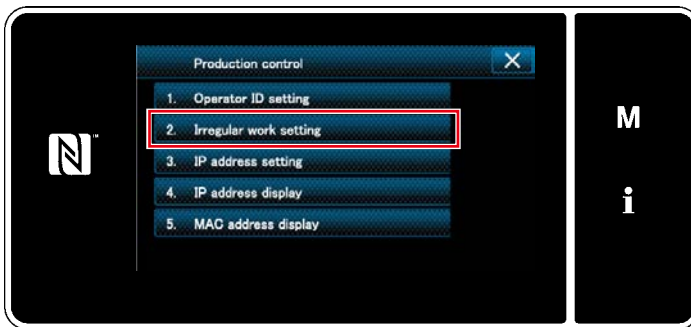

<Production management screen>

Display the "production management screen" referring to **"8-9-3.(1) Setting the operator ID" p.131.**

Select the "2. Irregular work setting".

The "irregular work edit screen" is displayed.

② Editing the irregular work

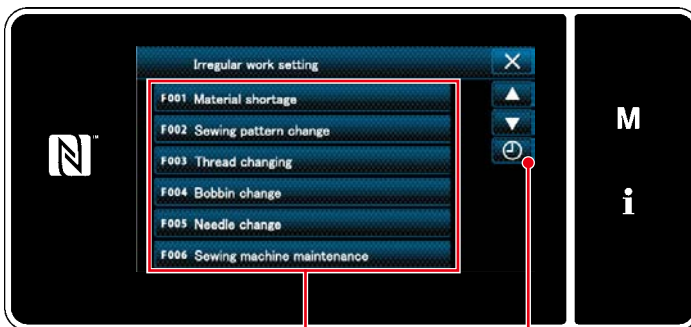

<Irregular work edit screen>

1. Display/non-display of irregular works is changed over by pressing item ①.

2. Press ②.

The "irregular work hours input screen" is displayed.

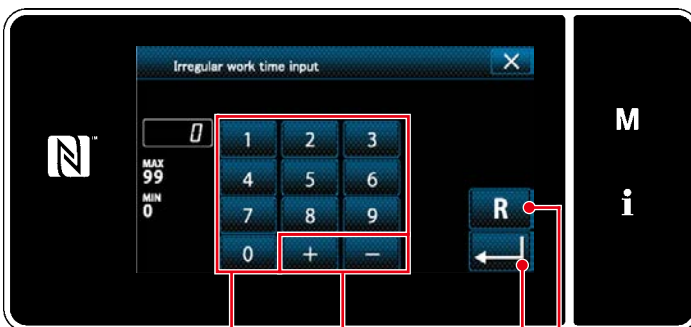

<Irregular work hours input screen>

3. Enter the work hours with numeric keypad

and ④.

The numerical value is returned to the initial value by pressing ⑤.

Press ⑥ to confirm the setting.

The "irregular work edit screen" is displayed.

The irregular work screen is displayed if the sewing machine does not run at the preset time.

Select the work content and press to return to the normal work.

8-9-4. NFC

The operation panel supports NFC (Near Field Communication).

Sewing data, maintenance information or the like can be viewed, edited, copied, etc., on an Android terminal (such as tablet and smartphone) on which JUKI application for Android "JUKI Smart App" has been installed, by means of the NFC communication function.

Refer to the Instruction Manual for JUKI Smart App for details of JUKI application for Android "JUKI Smart App".

① Position of the NFC antenna

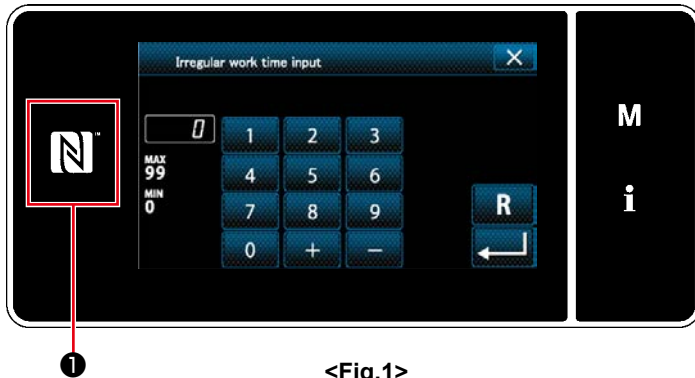

<Fig.1>

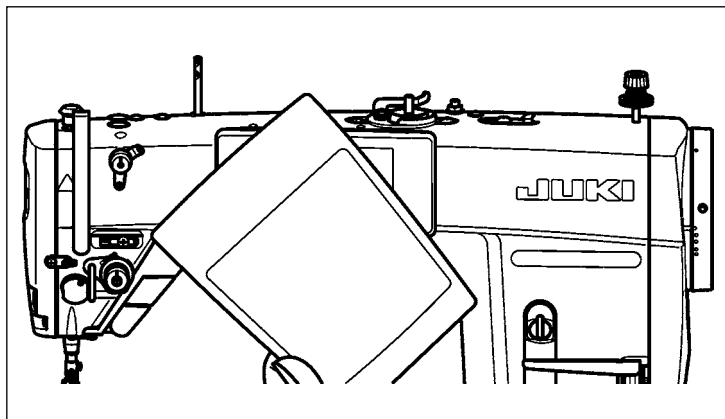

<Fig.2>

[Position of the NFC antenna]

In the case of carrying out the NFC communication between the sewing machine and a tablet or smartphone, bring the antenna of the tablet or smartphone near to NFC mark ① as shown in Fig. 2.

* If the NFC communication has failed, error message will be displayed on the tablet/smartphone screen.

When the error message is displayed on the screen, carry out the NFC communication again.

② Precautions to be taken when handling NFC

- The position of the NFC antenna varies according to the tablet/smartphone used. Be sure to read the instruction manual of your device before using the NFC communication function.
- To use the NFC communication function, place the NFC communication function setting in "Enable" while referring to the instruction manual for your tablet/smartphone.

8-10. Key customization

It is possible to register a desired function to a key to customize the peel key arrays. Functions that can be assigned to panel keys are as described below.

The key to which no function is assigned is displayed in blank.

8-10-1. Assignable data

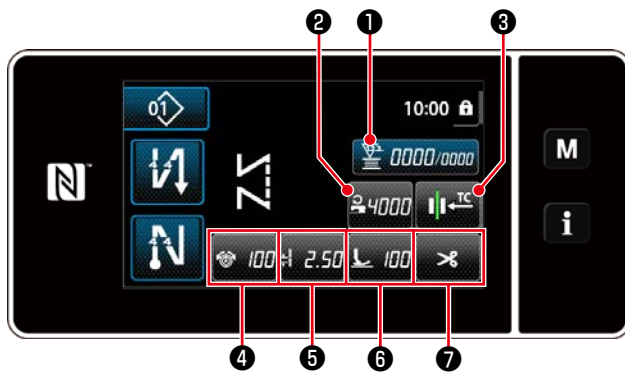

<Sewing screen (Operator mode)>

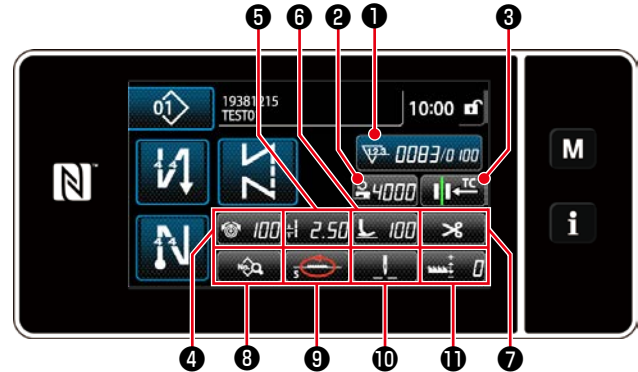

<Sewing screen (Maintenance personnel mode)>

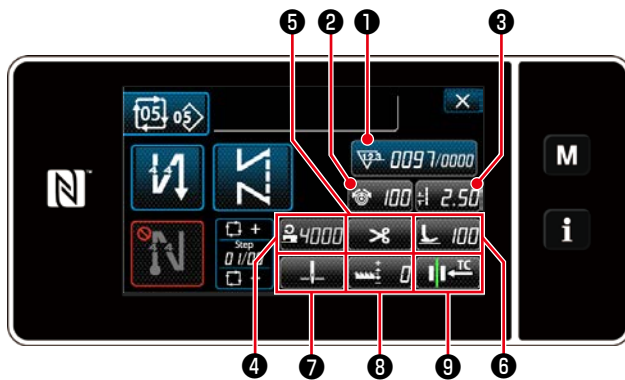

<Sewing screen (Cycle mode)>

	Initial value			Assignable data
	Operator mode	Maintenance personnel mode	Cycle mode	
①	Counter	Counter	Counter	Sewing pattern data Sewing pattern number Cycle pattern number Memory switch One-touch changeover Bobbin winding Counter Function is not provided
②	Sewing speed	Sewing speed	Thread tension	Sewing pattern data Sewing pattern number Cycle pattern number Memory switch One-touch changeover Bobbin winding Function is not provided
③	Thread presser	Thread presser	Sewing pitch	
④	Thread tension	Thread tension	Sewing speed	
⑤	Sewing pitch	Sewing pitch	Thread trimming	
⑥	Presser foot pressure	Presser foot pressure	Presser foot pressure	
⑦	Thread trimming	Thread trimming	Stop position of needle bar	
⑧		Sewing data list	Feed dog height	
⑨		Feed mode	Thread presser	
⑩		Stop position of needle bar		
⑪		Feed dog height		

8-10-2. How to assign a function to a key

① Displaying the key customization mode list screen

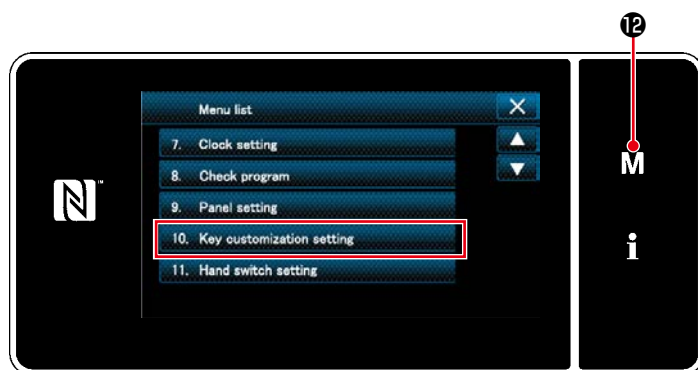

<Mode screen>

1. Press **M** ¹².

The "mode screen" is displayed.

2. Select the "10. Key customization setting".

The "key customization mode list screen" is displayed.

② Setting the key customization

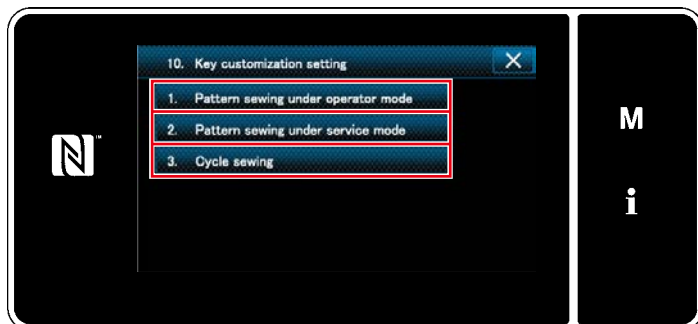

<Key customization mode list screen>

1. Select "1. Pattern sewing under operator mode". Then, "key customization assignment screen (operator mode)" is displayed.
2. Select "2. Pattern sewing under service mode". Then, "key customization assignment screen (Maintenance personnel mode)" is displayed.
3. Select "3. Cycle sewing". Then, "key customization assignment screen (Cycle mode)" is displayed.

③ Selecting a function to be assigned

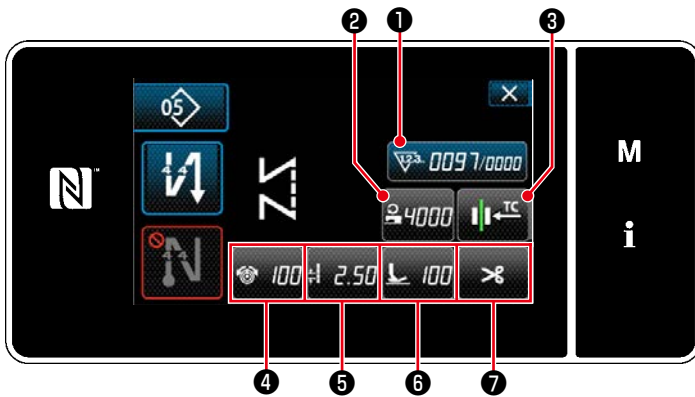

<Key customization assignment screen(Operator mode)>

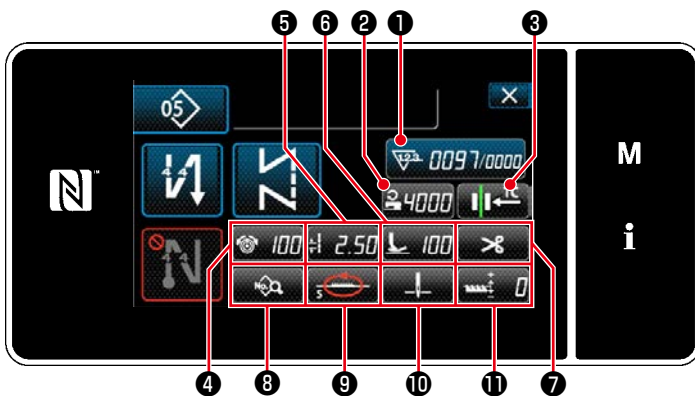

<Key customization assignment screen
(Maintenance personnel mode)>

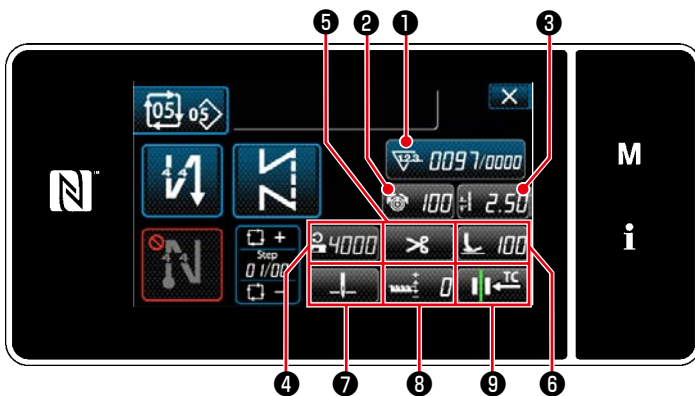

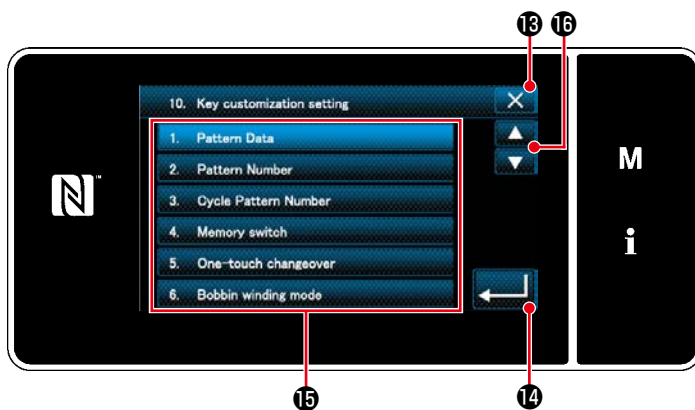

<Key customization assignment screen (Cycle mode)>



<Key customization assignment screen>

The key customization selection screen is displayed by pressing one of the ② to ⑪ (② to ⑦ for the operator mode. ② to ⑨ for the cycle mode.)

1. Press  ⑫ and each function button ⑮ to assign the key to ② to ⑪ (② to ⑦ for the operator mode. ② to ⑨ for the cycle mode.)
2. The counter button is respectively displayed by pressing ① .
3. Press  ⑭ to confirm the setting.
Cancel the operation with  ⑬ . The current screen returns to the previous screen.