

***ENGLISH***

**AB-1351  
INSTRUCTION MANUAL**

\* "CompactFlash(TM)" is the registered trademark of SanDisk Corporation, U.S.A.

# CONTENTS

<b>I . Machine (about the sewing machine)</b> .....	<b>1</b>
<b>Precautions for use</b> .....	<b>1</b>
<b>1. Configuration</b> .....	<b>2</b>
<b>2. Specifications</b> .....	<b>3</b>
<b>2-1. Mechanical specifications</b> .....	<b>3</b>
<b>2-2. Electrical specifications</b> .....	<b>4</b>
<b>2-3. Sewing shape of belt-loops</b> .....	<b>4</b>
<b>2-4. Garment body presser/work clamp foot specifications</b> .....	<b>6</b>
(1) Garment body presser .....	6
(2) Work clamp foot of the sewing machine .....	7
<b>3. Installation</b> .....	<b>8</b>
<b>3-1. Removing the packing materials</b> .....	<b>8</b>
<b>3-2. Fixing the machine</b> .....	<b>9</b>
<b>3-3. Connecting the air coupler</b> .....	<b>9</b>
<b>3-4. Connecting the power plug</b> .....	<b>10</b>
<b>3-5. Assembling the thread stand and installing on the machine</b> .....	<b>12</b>
<b>3-6. Installing the machine head support bar</b> .....	<b>12</b>
<b>3-7. Installing the operation panel IP-420</b> .....	<b>12</b>
<b>3-8. Installing the auxiliary table</b> .....	<b>13</b>
<b>3-9. Installing the manual pedal (optional)</b> .....	<b>13</b>
<b>3-10. Installing the belt loop feeding unit (optional)</b> .....	<b>14</b>
<b>3-11. Installing the additional marking light (optional)</b> .....	<b>15</b>
<b>4. Preparation of the sewing machine</b> .....	<b>16</b>
<b>4-1. Lubrication</b> .....	<b>16</b>
<b>4-2. Attaching the needle</b> .....	<b>16</b>
<b>4-3. Threading the machine head</b> .....	<b>17</b>
<b>4-4. Installing and removing the bobbin case</b> .....	<b>17</b>
<b>4-5. Installing the bobbin</b> .....	<b>18</b>
<b>4-6. Adjusting the thread tension</b> .....	<b>18</b>
<b>4-7. Adjusting the thread take-up spring</b> .....	<b>19</b>
<b>4-8. Example of the thread tension</b> .....	<b>19</b>
<b>5. Operating the sewing machine</b> .....	<b>20</b>
<b>5-1. Emergency stop switch</b> .....	<b>20</b>
(1) Method for operating the emergency stop switch .....	20
(2) Precautions with the emergency stop switch .....	20
<b>5-2. Winding a bobbin</b> .....	<b>21</b>
(1) To wind a bobbin while the sewing machine is performing sewing .....	21
(2) To wind a bobbin independently .....	21
<b>5-3. Thread clamp device</b> .....	<b>22</b>
<b>5-4. Placing a belt loop</b> .....	<b>23</b>
<b>5-5. Adjusting the belt loop tension</b> .....	<b>24</b>
<b>5-6. Setting the belt loop thickness</b> .....	<b>24</b>

5-7. Method for changing the belt loop width.....	25
5-8. Method for adjusting the workpiece stopper .....	26
5-9. Start switch.....	26

## **II . OPERATION (OPERATION PANEL) .....27**

<b>1. Introduction .....</b>	<b>27</b>
<b>2. Method for using the operation panel .....</b>	<b>31</b>
<b>2-1. Name of each section of IP-420 .....</b>	<b>31</b>
<b>2-2. Buttons to be used in common .....</b>	<b>32</b>
<b>2-3. Basic operation of IP-420 .....</b>	<b>33</b>
<b>2-4. Liquid crystal display section when the belt loop individual sewing is selected... 34</b>	
(1) Belt loop individual sewing data entry screen.....	34
(2) Belt loop individual sewing screen.....	36
<b>2-5. How to change over the sewing shape.....</b>	<b>38</b>
<b>2-6. How to change the belt loop length .....</b>	<b>39</b>
(1) How to change the belt loop dimensions .....	39
(2) Changing the belt loop length (entire length) and precautions to be taken .....	41
(3) Changing the belt loop length by the selection of the frame of the work clamp foot .....	41
<b>2-7. How to lower the garment body presser and the work clamp foot .....</b>	<b>42</b>
<b>2-8. Using counter.....</b>	<b>43</b>
(1) Setting procedure of the counter .....	43
(2) Count-up releasing procedure .....	46
(3) How to change the counter value during sewing .....	46
<b>2-9. How to register a new belt loop pattern number .....</b>	<b>47</b>
<b>2-10. How to name a belt loop pattern number .....</b>	<b>49</b>
<b>2-11. How to select a belt loop pattern number.....</b>	<b>50</b>
(1) Selection on the data entry screen .....	50
(2) Selection by the direct button .....	51
<b>2-12. How to copy a belt loop pattern number .....</b>	<b>52</b>
<b>2-13. Belt loop teaching function.....</b>	<b>53</b>
<b>2-14. How to carry out the step operation .....</b>	<b>55</b>
(1) Setback step operation .....	56
(2) Sewing position step operation.....	56
<b>2-15. Function of canceling grasping of a belt loop for the next sewing .....</b>	<b>58</b>
<b>2-16. How to carry out the bartacking setting .....</b>	<b>59</b>
<b>2-17. Liquid crystal display at the time of setting the bartacking .....</b>	<b>60</b>
(1) LK unit data entry screen.....	60
(2) LK unit sewing screen.....	62
<b>2-18. How to select the sewing shape (bartacking setting) .....</b>	<b>64</b>
<b>2-19. List of sewing shapes.....</b>	<b>65</b>
<b>2-20. How to change the item data (bartacking setting).....</b>	<b>66</b>
<b>2-21. How to check the sewing shape.....</b>	<b>67</b>
<b>2-22. How to change the thread tension command from needle entry point to needle entry point....</b>	<b>68</b>
(1) How to add/change the thread tension command from needle entry point to needle entry point ...	68
(2) How to delete the thread tension command from needle entry point to needle entry point.....	69
<b>2-23. How to register a new user-pattern.....</b>	<b>71</b>
<b>2-24. How to change the sewing mode .....</b>	<b>72</b>

<b>2-25. LCD section when the cycle sewing is selected</b> .....	<b>73</b>
(1) Cycle sewing data entry screen.....	73
(2) Sewing screen of the cycle sewing.....	75
<b>2-26. How to carry out cycle sewing</b> .....	<b>77</b>
(1) Selection of the cycle-sewing data .....	77
(2) Method to create the cycle-sewing data .....	78
(3) Method to insert the cycle-sewing data .....	79
(4) Method for deleting the cycle sewing data.....	80
(5) Method for deleting a step of the cycle sewing data.....	80
<b>2-27. How to edit the sewing data</b> .....	<b>81</b>
(1) Method for changing the sewing data .....	81
(2) Sewing data list.....	82
<b>2-28. How to change the memory switch data</b> .....	<b>93</b>
(1) Method for changing the memory switch data .....	93
(2) Memory switch data list .....	94
<b>2-29. How to set the device</b> .....	<b>98</b>
(1) Device setting changing procedure .....	98
(2) Listing of the device settings.....	99
<b>2-30. How to adjust the origin of work clamp foot</b> .....	<b>101</b>
<b>2-31. Using communication function</b> .....	<b>102</b>
(1) Handling possible data .....	102
(2) Performing communication by using the media.....	102
(3) Performing communication by using USB .....	102
(4) Take-in of the data .....	103
(5) Taking in plural data together.....	104
<b>2-32. Performing formatting of the media</b> .....	<b>106</b>
<b>2-33. Trial stitching function</b> .....	<b>107</b>
<b>2-34. How to use information</b> .....	<b>109</b>
(1) How to visually check maintenance/inspection information.....	109
(2) How to reset the warning .....	111
(3) How to set the time .....	111
<b>2-35. How to re-start sewing from the position where the machine has stopped by the detection of thread breakage</b> .....	<b>112</b>
<b>3. ERROR CODE LIST</b> .....	<b>113</b>
<b>4. Massage list</b> .....	<b>126</b>
<b>III. Maintenance</b> .....	<b>130</b>
<b>1. Maintenance</b> .....	<b>130</b>
<b>1-1. Discharging drainage water</b> .....	<b>130</b>
<b>1-2. Adjusting the height of the needle bar</b> .....	<b>130</b>
<b>1-3. Adjusting the needle-to-shuttle relation</b> .....	<b>131</b>
<b>1-4. Adjusting the lift of the work clamp foot</b> .....	<b>132</b>
<b>1-5. The moving knife and counter knife</b> .....	<b>132</b>
<b>1-6. Needle thread clamp device</b> .....	<b>133</b>
<b>1-7. Adjustment of the wiper</b> .....	<b>133</b>
<b>1-8. Thread breakage detector plate</b> .....	<b>134</b>
<b>1-9. Draining waste oil</b> .....	<b>134</b>

1-10. Amount of oil supplied to the hook.....	134
1-11. Replacing the work clamp foot of the sewing machine .....	135
1-12. Replacing the feed plate of the sewing machine .....	135
1-13. Replacing the fork.....	136
1-14. Replacing the fuse .....	136
1-15. Changing the voltage of 100/200V.....	137
1-16. Replenishing the designated places with grease .....	138
(1) Addition of grease to the machine head .....	138
(2) Addition of grease to devices.....	140
1-17. Troubles and corrective measures (sewing conditions).....	142
<b>2. Option .....</b>	<b>144</b>
2-1. Optional parts.....	144
2-2. Gauges .....	144
2-3. Miscellaneous .....	144
2-4. Silicon oil pipes.....	144

# I . Machine (about the sewing machine)

## Precautions for use

Following items have to be checked every working day before the operation of the machine and before the start of work hours.

- 1. Ascertain that the oil pan is filled with the predetermined amount of oil.**
- 2. Never operate the machine unless the oil pan has been filled up with oil.**
- 3. Ascertain that the pressure gauge indicates the designated air pressure of 0.5 MPa.**  
\* (This is necessary particularly when the compressor is stopped for a lunch break or the like.)  
If the compressed air pressure is equal to or less than the designated value, troubles such as interference between the parts can occur. It is therefore necessary to carefully check the compressed air pressure.
- 4. Check whether the needle thread/bobbin thread need to be replenished.**
- 5. To perform sewing immediately after turning ON the power switch, perform trial stitching first, then proceed with sewing of actual products after the test sewing.**
- 6. In the case drainage water accumulates in the regulator section, expel it from there before starting work.**

## 1. Configuration

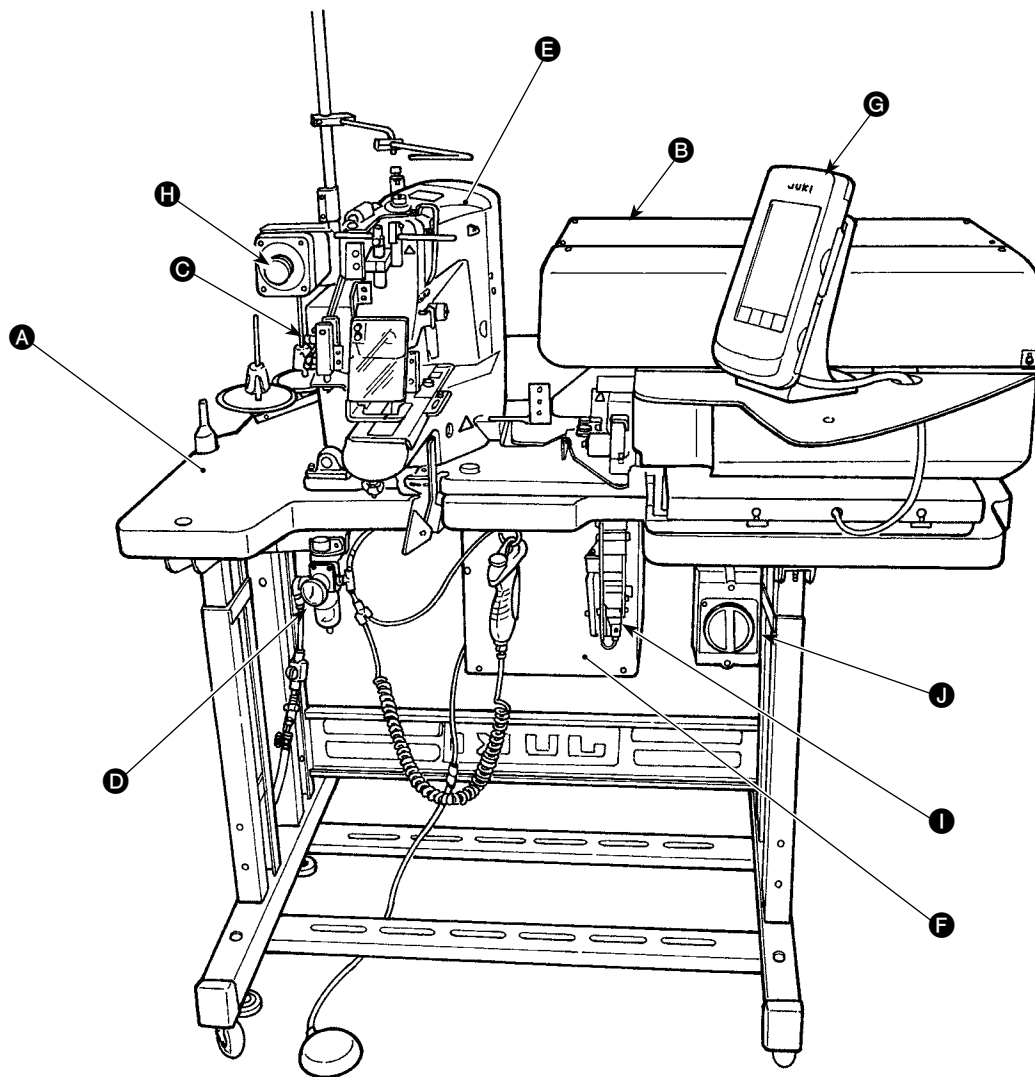

This machine consists of the following nine sections:

- Ⓐ Mechanical section of the main body structure (table stand, table, covers, start switch, etc.)
- Ⓑ Belt loop feeder unit (belt loop draw-out device, belt loop drawing device, etc)
- Ⓒ Belt loop tension releasing unit
- Ⓓ Pneumatic control equipment section (pneumatic equipment, pneumatic piping, etc.)
- Ⓔ Sewing machine section
- Ⓕ Control device
- Ⓖ Operation panel
- Ⓗ Emergency stop switch
- Ⓘ Belt-loop feeding unit (optional)
- ⓰ Power switch

The machine is able to automatically sew desired belt-loops only by operating the start switch after having placed a material (garment body) at the predetermined position on the machine.

When you press emergency stop switch Ⓗ, the power to the devices are turned OFF to stop them.

## 2. Specifications

### 2-1. Mechanical specifications

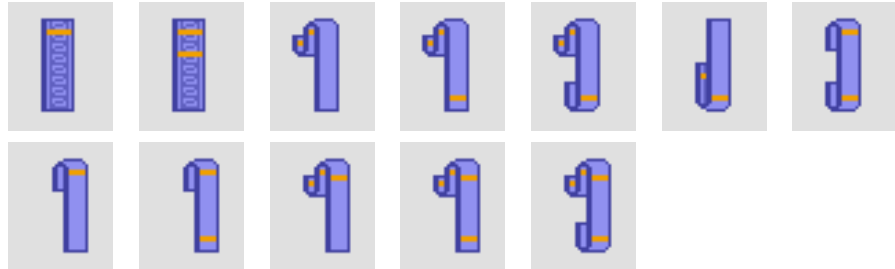
1	Sewing machine in use	LK-1961/AB H (exclusive intermediate machine head AB-1351 based on LK-1900A SS)
2	Sewing speed	Max. number of revolutions 2,500 sti/min (adjustable range: 400 to 2,500 sti/min) The stitching pitch has to be set at 3.2 mm or less. (Stitching pitch is input in increments of 100 sti/min.)
3	Belt-loop shape	
4	Belt-loop width	8 to 20 mm
5	Standard sewing pattern	* Linear bartacking (exclusive pattern for AB-1351) Pattern No. selection method (from among 12-stitch, 15-stitch, 21-stitch, 28-stitch, 36-stitch and 41-stitch) is adopted. The widthwise pattern size is input on the operation panel. The lengthwise pattern size is restricted to the 0 mm, and the widthwise one is restricted to the range from 6 mm to 23 mm. (The lengthwise pattern size is input in increments of 0.1 mm.) * Zigzag bartacking (exclusive pattern for AB-1351) Pattern No. selection method (from among 28-stitch, 36-stitch, 42-stitch, 56-stitch and 64-stitch) is adopted. The widthwise and lengthwise pattern sizes are input on the operation panel. The lengthwise pattern size is restricted to the range from 1 mm to 3.2 mm, and the widthwise one is restricted to the range from 6 to 23 mm. (The lengthwise/widthwise pattern size is input in increments of 0.1 mm.)
6	Lift of the work clamp foot of sewing machine	The distance from the top surface of the throat plate to the undersurface of the work clamp foot is 20 mm.
7	Needle bar stroke	45.7 mm (for 1903A)
8	Needle	ORGAN needle DP x 17 #14 (Standard)
9	Hook in use	Semi-rotary standard hook (x1.0)
10	Thread	Spun #50 (recommended) Filament #50
11	Safety feature	The machine automatically stops in the case a belt-loop clamping fault or thread breakage is detected.
12	Lubrication oil	JUKI New Defrix Oil No.2
13	Air pressure used	0.5 MPa
14	Air consumption	10 dm <sup>3</sup> (ANR)/min or less
15	Dimensions	W: 1,200 mm L: 850 mm H: 1,210 mm
16	Weight	205.5 Kg
17	Noise	Declaration - Equivalent continuous emission sound pressure level (L <sub>pA</sub> ) at the workstation : A-weighted value of 82.0 dB; (Includes K <sub>pA</sub> = 2.5 dB); according to ISO 10821- C.6.3 -ISO 11204 GR2 at 2,500 sti/min for the sewing cycle, 5.5s ON. (Pattern: No.4, 21 Stitches, Max Speed) - Sound power level (L <sub>WA</sub> ) ; A-weighted value of 85.0 dB; (Includes K <sub>WA</sub> = 2.5 dB); according to ISO 10821- C.6.3 -ISO 3744 GR2 at 2,500 sti/min for the sewing cycle, 5.5s ON. (Pattern: No.4, 21 Stitches, Max Speed)
18	Laser marking	Class 2 laser product Maximum output: 1.0mW Wave length: 650nm  Safety standard JIS C 6802:2005 IEC60825-1+A2:2007



## 2-2. Electrical specifications

1	Number of patterns that can be stored in memory	99 patterns can be set.
2	Number of cycles that can be stored in memory	Number of programs: 20 For each program, as many as 30 belt-loops can be set.
3	Input power source	Single-phase 200 – 240 VAC, 50/60Hz 3-phase, 200 - 240 VAC, 50/60 Hz (switchable to single-phase 100 - 120 V) Supply voltage fluctuation: Rated voltage $\pm$ 10 % or less * Adaptable to 380/400/415 VAC with the addition of an optional transformer.
4	Power consumption	3-phase, 200 V type: 250 VA (instantaneous maximum power consumption: 450 VA) Single-phase, 220 V type: 280 VA (instantaneous maximum power consumption: 670 VA) * Average power when the machine sews 4000 belt-loops in eight hours under No. 4 sewing mode.

## 2-3. Sewing shape of belt-loops

		Work clamp foot for linear bartacking	Work clamp foot for zigzag bartacking
No.1		A = 4 mm * (-10 to 19) B = 59 to 99 mm	A = 6 mm * (-9 to 21) B = 59 to 99 mm
No.2		A = 4 mm * (-10 to 19) B = 15 to 30 mm C = 45 to 99 mm	A = 6 mm * (-9 to 21) B = 15 to 30 mm C = 45 to 99 mm
No.3		A = 4 mm * (-10 to 19) B = 45 to 109 mm C = 5 to 11 mm D = (2) mm	A = 6 mm * (-9 to 21) B = 45 to 109 mm C = 5 to 11 mm D = (2) mm
No.4		A = 4 mm * (-10 to 19) B = 30 to 50 mm C = 5 to 11 mm D = 5 to 30 mm E = 6 mm * (-14 to 16)	A = 6 mm * (-9 to 21) B = 30 to 50 mm C = 5 to 11 mm D = 5 to 30 mm E = 12 mm * (-12 to 22)
No.5		A = 4 mm * (-10 to 19) B = 30 to 61 mm C = 5 to 11 mm D = 2 to 8 mm E = 2.5 mm * (-2.5 to 7.5) F = 10 mm * (0 to 20)	A = 6 mm * (-9 to 21) B = 30 to 61 mm C = 5 to 11 mm D = 2 to 8 mm E = 4 mm * (-1 to 9) F = 10 mm * (0 to 20)
No.6		A = 4 mm * (-16 to 19) B = 45 to 99 mm C = 15 to 30 mm D = 2.5 mm * (-2.5 to 7.5)	A = 6 mm * (-9 to 21) B = 45 to 99 mm C = 15 to 30 mm D = 4 mm * (-1 to 9)

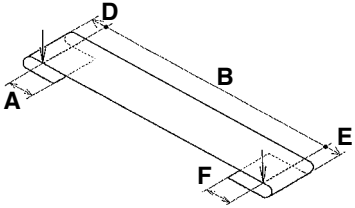
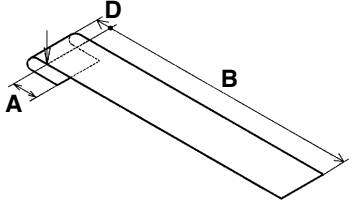
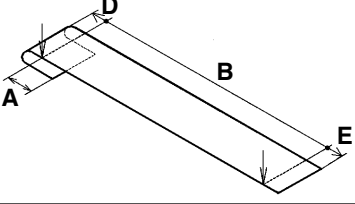
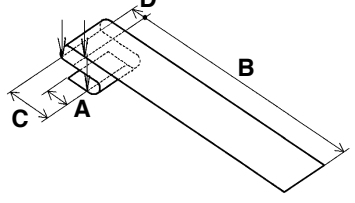
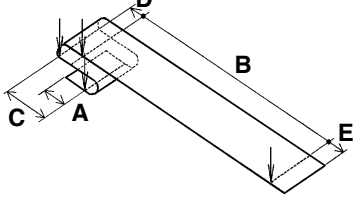
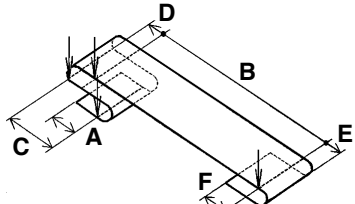
		Work clamp foot for linear bartacking	Work clamp foot for zigzag bartacking
No.7		A = 10 mm * (0 to 15) B = 30 to 63 mm D = 4 mm * (0 to 10) E = 4 mm * (0 to 10) F = 10 mm * (0 to 20) Loosening amount = 0 to 20 mm	A = 10 mm * (0 to 15) B = 30 to 63 mm D = 3 mm * (0 to 10) E = 3 mm * (0 to 10) F = 10 mm * (0 to 20) Loosening amount = 0 to 20 mm
No.8		A = 10 mm * (0 to 15) B = 49 to 109 mm D = 4 mm * (0 to 10)	A = 10 mm * (0 to 15) B = 45 to 109 mm D = 3 mm * (0 to 10)
No.9		A = 10 mm * (0 to 15) B = 30 to 60 mm D = 4 mm * (0 to 10) E = 6 mm * (-14 to 16) Loosening amount = 5 to 30 mm	A = 10 mm * (0 to 15) B = 30 to 60 mm D = 3 mm * (0 to 10) E = 12 mm * (-12 to 22) Loosening amount = 5 to 30 mm
No.10		A = 4 mm * (-10 to 19) B = 45 to 109 mm C = 5 to 11 mm D = 4 mm * (0 to 4)	A = 6 mm * (-9 to 21) B = 45 to 109 mm C = 5 to 11 mm D = 3 mm * (0 to 4)
No.11		A = 4 mm * (-10 to 19) B = 30 to 50 mm C = 5 to 11 mm D = 4 mm * (0 to 4) E = 6 mm * (-14 to 16) Loosening amount = 5 to 30 mm	A = 6 mm * (-9 to 21) B = 30 to 50 mm C = 5 to 11 mm D = 3 mm * (0 to 4) E = 12 mm * (-12 to 22) Loosening amount = 5 to 30 mm
No.12		A = 4 mm * (-10 to 19) B = 30 to 56 mm C = 5 to 11 mm D = 4 mm * (0 to 4) E = 2.5 mm * (-2.5 to 7.5) F = 10 mm * (0 to 20) Loosening amount = 4 to 16 mm	A = 6 mm * (-9 to 21) B = 30 to 56 mm C = 5 to 11 mm D = 3 mm * (0 to 4) E = 4 mm * (-1 to 9) F = 10 mm * (0 to 20) Loosening amount = 4 to 16 mm



1. The range of belt-loop feeding length (the entire length of a belt-loop shown on the operation panel) is from 58 mm to 130 mm. If the belt-loop feeding length exceeding the aforementioned range is set, an error will occur.
  2. In the case "distance B + distance D" exceeds 66 mm for pattern No. 4 or No. 5, "distance B + loosening amount/2" exceeds 66 mm for pattern Nos. 7 and 12, or "distance B + loosening amount" exceeds 66 mm for pattern Nos. 9 and 11, an error will occur.
  3. The dimensions of the belt loop sewing shape displayed on the operation panel are only for reference. The dimensions vary according to the belt-loop material. Be sure to adjust the settings of belt loop dimensions so that your desired finished dimensions are achieved.
- \* Numerical values shown in parentheses are set values. They are not the finished dimensions.

## 2-4. Garment body presser/work clamp foot specifications

### (1) Garment body presser

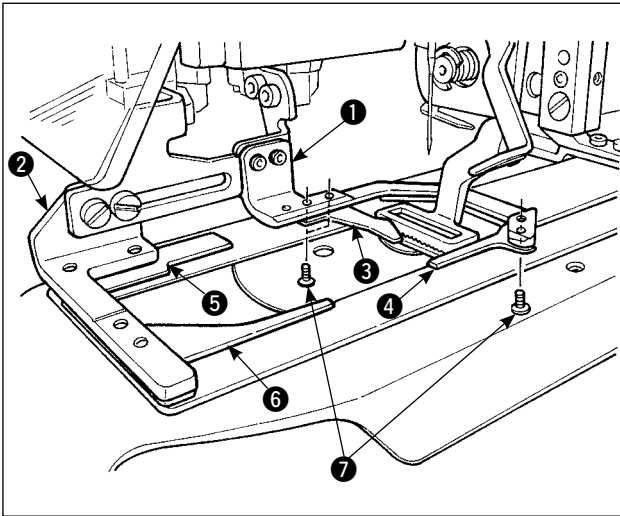

Garment body presser ① and ② for securing the garment body is provided as standard with auxiliary clamps ③, ④, ⑤ and ⑥.

Be aware that the auxiliary clamps ③ may be required to be removed according to the sewing shape of the belt-loop.

In the case of two kinds of sewing shapes; No. 2 and No. 6, auxiliary clamp ③ has to be removed.

Loosen two screws ⑦ and remove the auxiliary clamps ③ from the garment body presser ①.

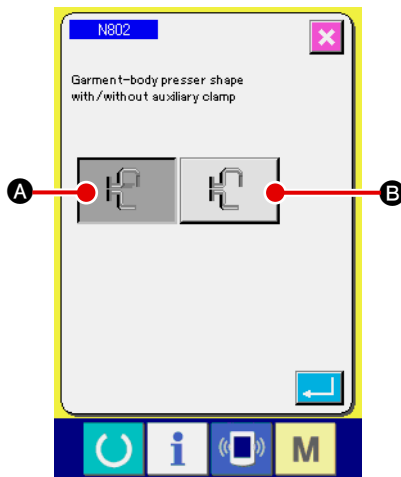

If you have changed the garment body presser, set the machine setting N802 according to the garment body presser actually being used.

Ⓐ Additional clamp is provided

Ⓑ Additional clamp is not provided

→ Refer to "[II-2-29. How to set the device](#)", p.98.



1. For belt loop shapes Nos. 5 and 7, auxiliary clamps ④ and ⑥ are damaged since they are rubbed by the fork pin which rolls the belt loop. If the auxiliary clamps are heavily damaged, they can deform or break. It is necessary to periodically change auxiliary clamps with new ones.
2. Install the auxiliary clamps at right angles to garment body pressers ① and ②. Be sure to check that the auxiliary clamps do not interfere with other parts.

## (2) Work clamp foot of the sewing machine

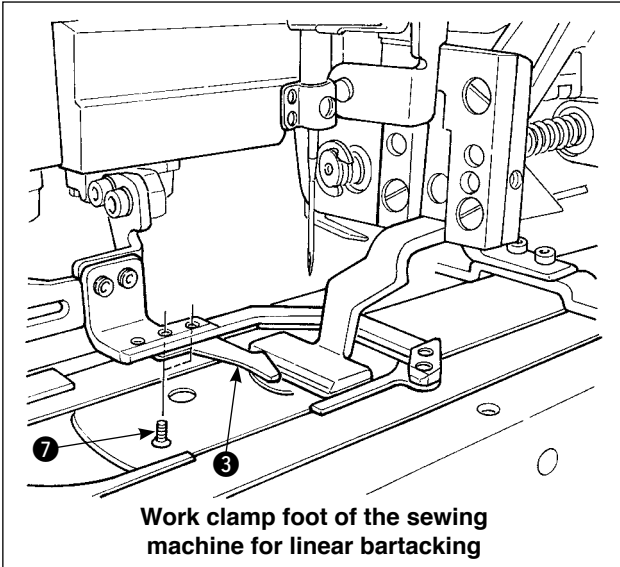

The work clamp foot of the sewing machine for linear bartacking is mounted as standard.

It is used when linear bartacking is used for sewing various kinds of belt loops.

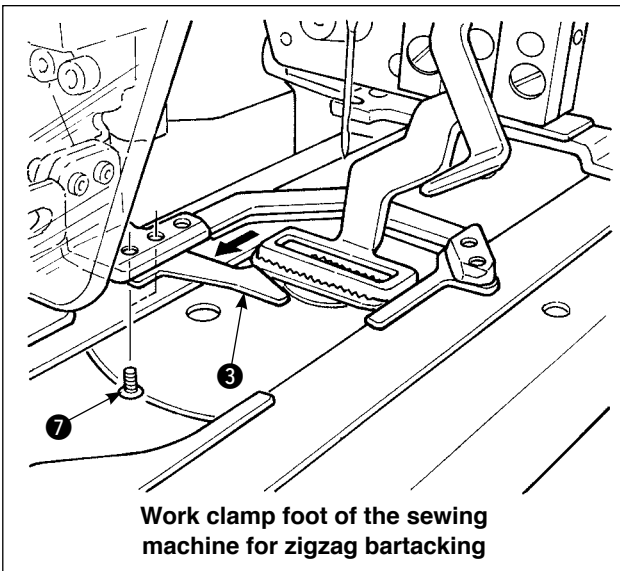

Be aware that, to carry out zigzag bartacking, the currently installed work clamp foot and the feed plate have to be replaced with those for zigzag bartacking, and zigzag bartacking has to be set on the operation panel.

In addition, when the work clamp foot for zigzag bartacking is installed, auxiliary clamp ③ has to be re-positioned accordingly by loosening two screws ⑦ as shown in the figure at the left. (Refer to "[I -2-4 \(1\) Garment body presser/work clamp foot specifications](#)", p.6.)

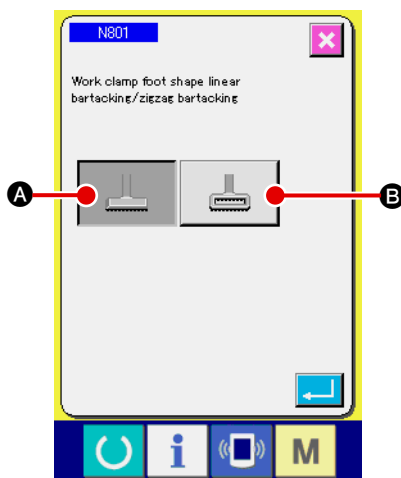

If you have changed the work clamp foot of the sewing machine, set the machine setting N801 according to the work clamp foot actually being used.

- Ⓐ Feeding frame for linear bartacking (initial value)
- Ⓑ Feeding frame for zigzag bartacking

→ Refer to "[II -2-29. How to set the device](#)", p.98.

### 3. Installation

#### 3-1. Removing the packing materials



**CAUTION :**

1. If you lift the machine, do not hold any of the devices or the mechanical section of the sewing machine but hold the table.
2. When you move the machine, the machine head fixation bolt must be attached to the machine. Be sure to carefully keep the machine head fixation bolt.

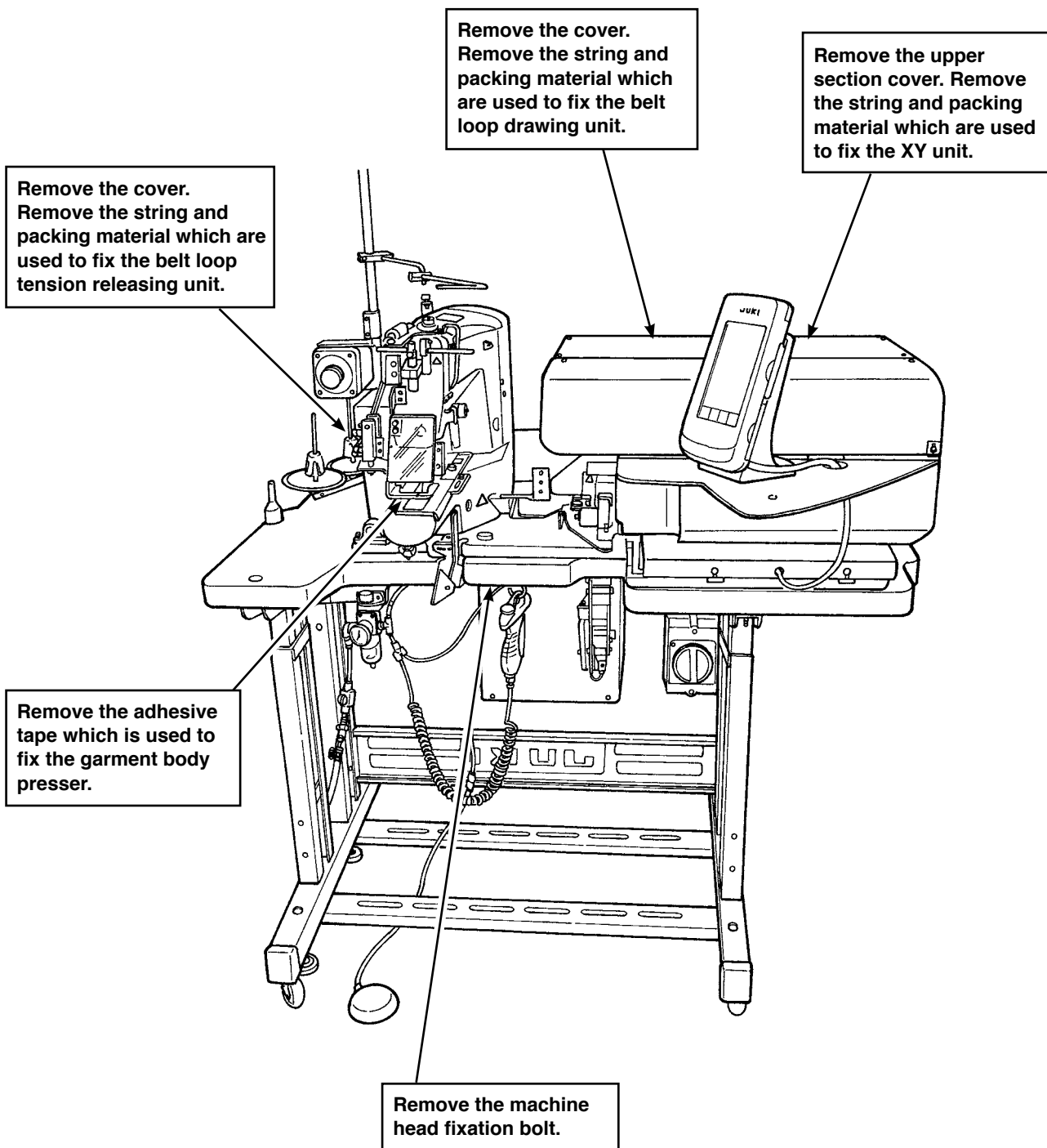

### 3-2. Fixing the machine

#### CAUTION :



1. In order to protect against accidents causing personal injury or death, move the machine to a level and stable place and secure it by lowering adjuster bolts ② (at four locations) placed at the side of casters ①.
2. When adjusting the leg height of the sewing machine, the leg fixing bolts ③ need to be loosened to move the leg up or down. When the fixing bolts have been loosened, there is a danger for the legs to suddenly drop down. Therefore, be careful when loosening the bolts.

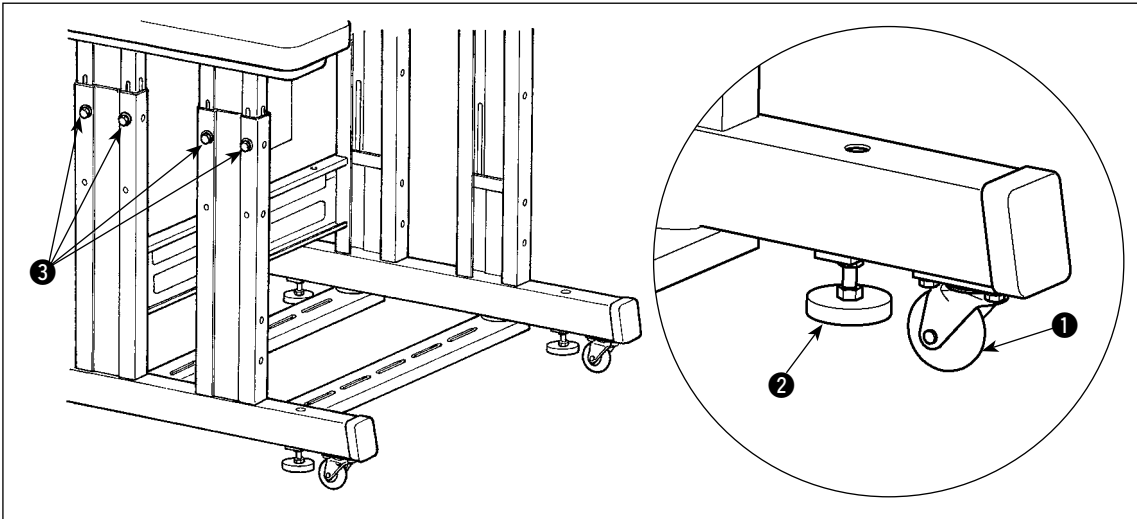

### 3-3. Connecting the air coupler

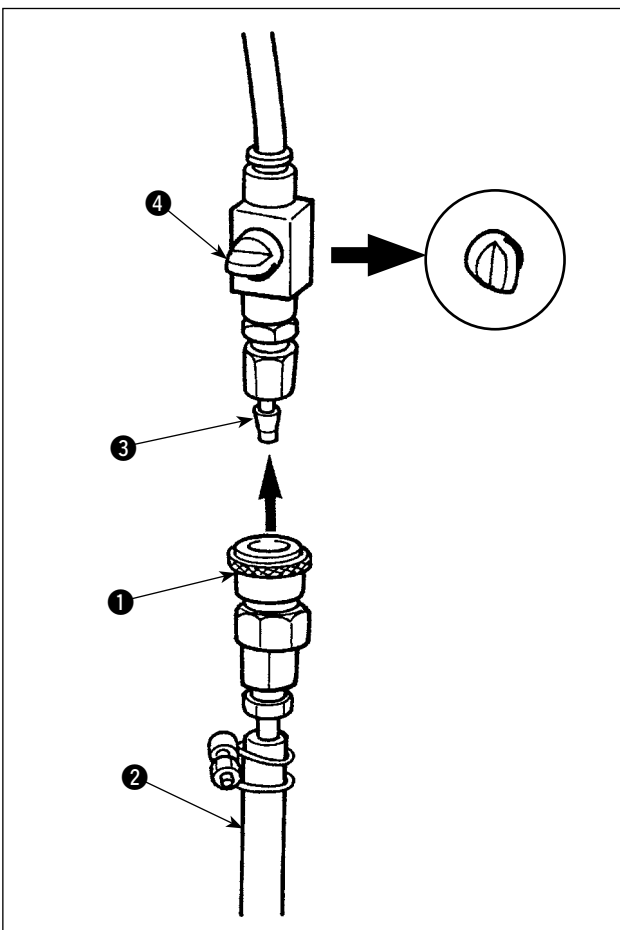

Connect air coupler ① supplied with the unit as an accessory to air hose ②. Then, connect the air coupler to coupler ③ on the main body side.



1. After having connected coupler ① with air cock ④ closed, carefully open air cock ④ to supply air.
2. Check to be sure that the pressure gauge of the regulator indicates 0.5 MPa.

### 3-4. Connecting the power plug



#### CAUTION :

In order to protect against accidents caused by a ground fault or dielectric voltage, be sure to have the adequate power plug mounted by a person who has electrical expertise. It is also important to connect the power plug to the grounded receptacle.

The method to connect the product to the power source differs by the product specifications. Be sure to connect the product to the power source according to the power specifications.

- ① For the single-phase, 200 - 240 V type product  
Connect the sky-blue/brown wire of the power cord to the supply terminal (200 - 240 VAC) and the yellow/green one to the earth terminal respectively.
- ② For the 3-phase, 200 - 240 V type product  
Connect the red/white/black wire of the power cord to the supply terminal (200 - 240 VAC) and the yellow/green one to the earth terminal respectively.
- ③ For the product provided with an high-voltage optional transformer  
Connect the black wires (three) of the power cord to the supply terminal (380 - 415 VAC) and the yellow/green wire to the earth terminal respectively. The product can be connected to 380/400/415 V power terminals according to the setting of the input tap of the transformer. (Standard setting at the time of shipment: 380 V)
- ④ In the case the single-phase, 200 - 240 V type product is modified to the 3-phase, 380/400/415 V type one  
Optional parts are required.
  - High-voltage optional transformer      Parts No.: 40005422
  - Power cord                                      Parts No.: 40070548



In the case of the 3-phase, 380/400/415 V power supply, this product is operated under the single-phase connection state.

#### [Precaution to be taken when changing the power of the high-voltage optional transformer]

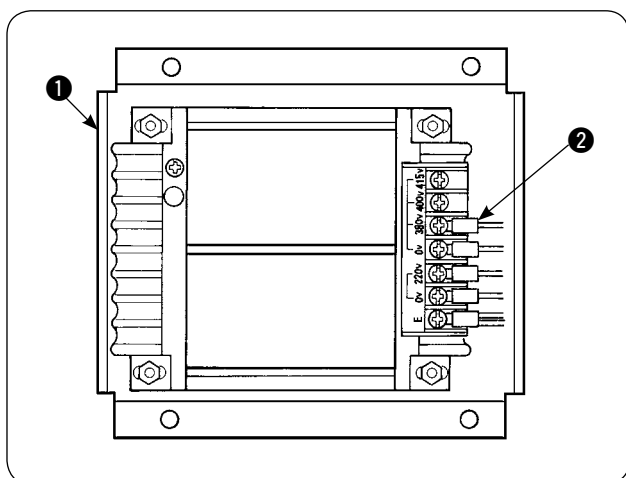

To use high-voltage optional transformer ① with the input voltage of 400 V or 415 V, you need to replace input power cord ② of high-voltage optional transformer ① correspondingly. Change power input cord ② (brown) which is connected to the 380 V power terminal with the one for 400 V or 415 V connection.



In order to protect against accidents, the aforementioned work should be carried out after having left the sewing machine for 5 minutes or more with the power switch turned OFF and the cord removed.

High-voltage optional transformer ① is placed on the side face of the control box.

**CAUTION :**

To protect against accidents such as an electric shock, be sure to turn the power off and remove the power cord from the receptacle before the following work.

**[How to install the high-voltage optional transformer (part number: 40090561)]**

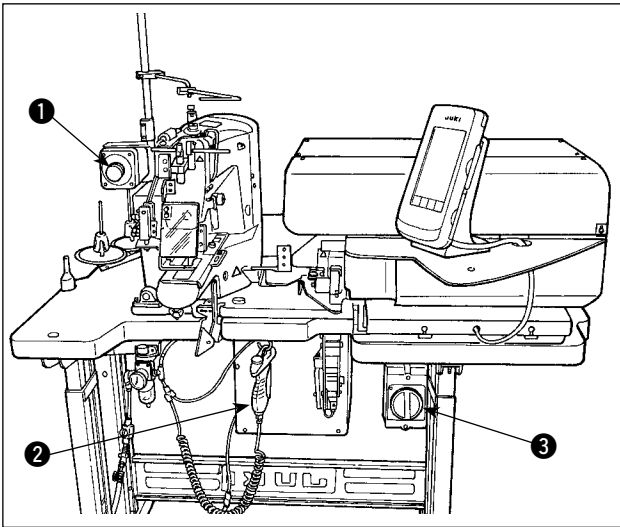

1) Loosen four screws on the front side of emergency stop switch ❶. Open the switch box. Remove the power cord (brown, sky blue, yellow/green wires) from the secondary side (on the side ❷ is printed).

2) Connect the power cord to the optional transformer. Connect the power cord (40005423: Three-wire cord) supplied with the unit to the optional transformer.  
 Brown wire → 380/400/415 V (according to the power specifications)  
 Blue wire → 0 V (next to the 380 V)  
 Yellow/green wire → E (on the ring terminal side)  
 Connect the cord on the control box side (the cord which has been removed in Step 1).  
 Brown wire → 220 V  
 Sky blue wire → (next to the E)  
 Yellow/green wire → E

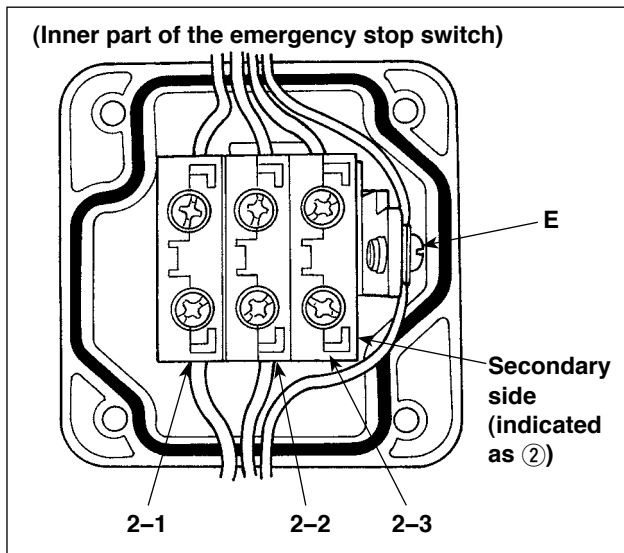

3) Install optional transformer on the side face of control box ❷. Refer to "HIGH VOLTAGE TRANSFORMER SETUP INSTRUCTION (40005426)" for connecting procedure.

4) Connect the power cord supplied with the unit to emergency stop switch ❶.  
 Brown wire → 2-1  
 Sky blue wire → 2-2  
 Yellow/green wire → E  
 (Brown and sky blue wires respectively have a fork terminal.)

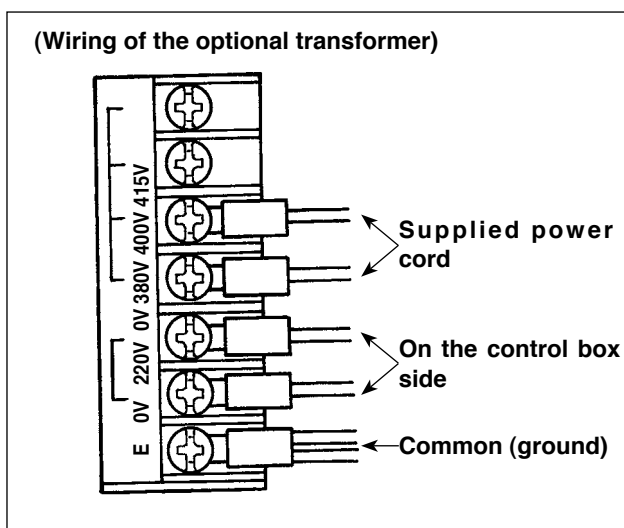

5) Re-tighten the four screws of emergency switch ❶. Take care not to leave a gap in the switch.

6) Change the cord on the plug side of the power switch. (40070548: 4-wire cord)  
 Open the power switch. Remove connection cords on the side of L1, L2 and L3.  
 Black 1, 2 and 3 wires (on the forked terminal side) → L1, L2 and L3 in the power switch  
 Yellow/green wire → Ground (in the power switch)

**\* Discard the cord mounted your machine at the time of delivery.**



### 3-5. Assembling the thread stand and installing on the machine

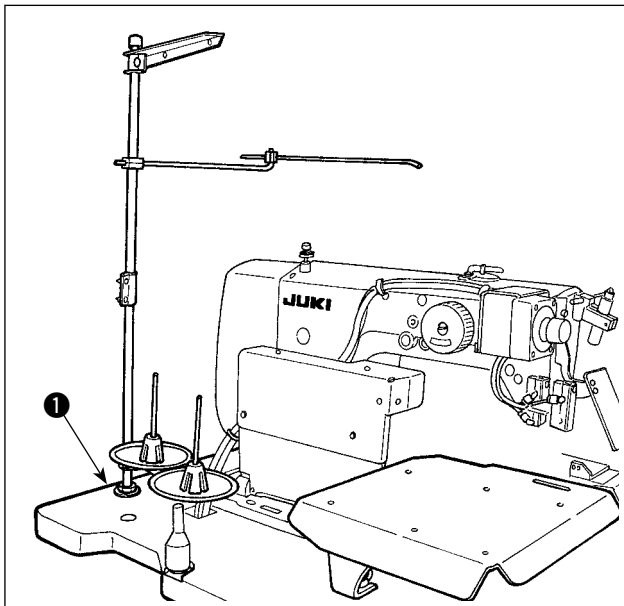

Insert the thread stand in the hole in table ① and fix by fastening a washer and a nut placed on the top and underside of table.

### 3-6. Installing the machine head support bar

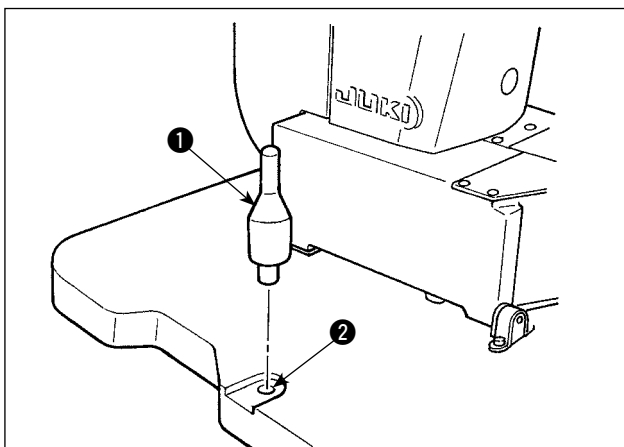

Securely mount machine head support bar included in the accessories supplied with the unit.

Drive machine head support bar ① in hole ② in the machine table.



When tilting the sewing machine, tilt the sewing machine slowly so that no excessive force will be applied to the head support bar.

And when returning the sewing machine back to its original position, be careful not to have your hand get caught between the base and the sewing machine bed.

### 3-7. Installing the operation panel IP-420

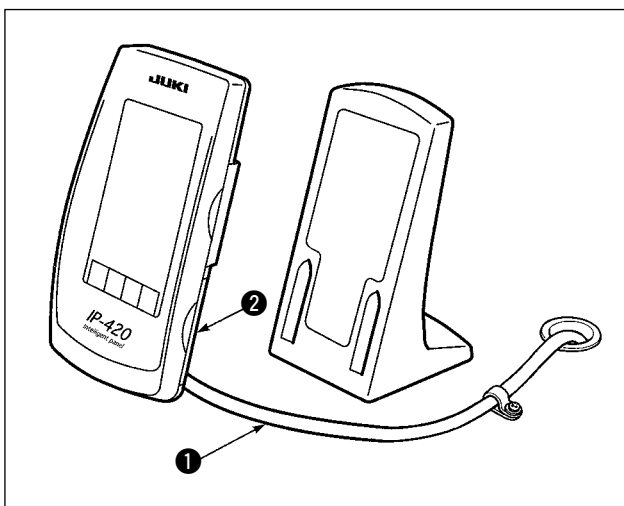

Open the cover on right side face ② section of the IP-420 and connect the connector of cable ① which is secured with adhesive tape on the upper right face of the table to the IP-420.



To protect the operation panel IP-420 from malfunctioning due to static electricity, mount the operation panel on the operation panel base.

### 3-8. Installing the auxiliary table

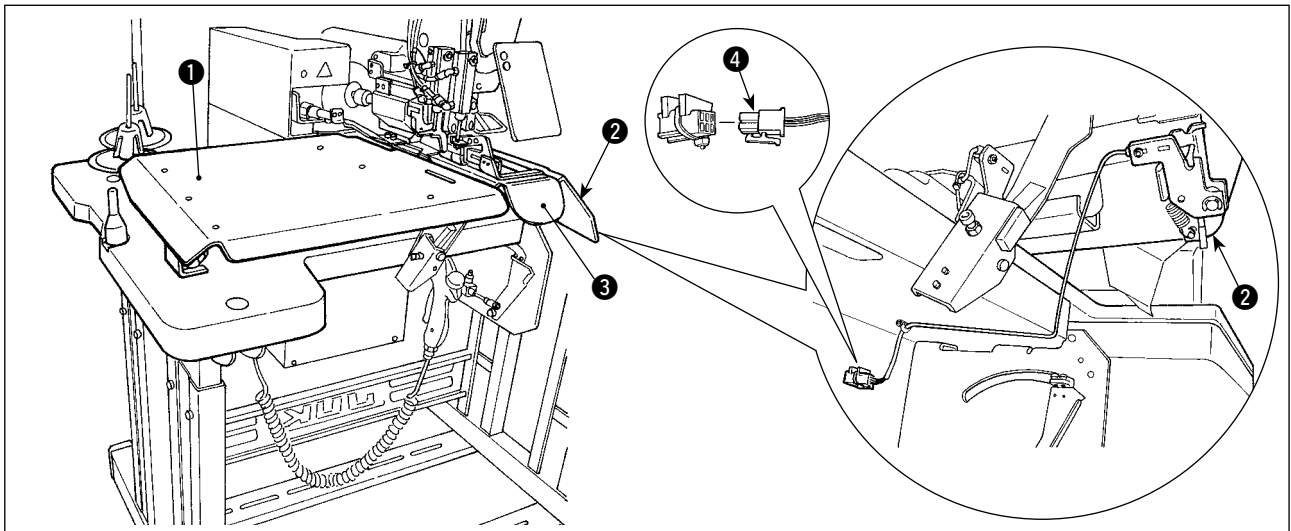

Loosen the butterfly nut on the top surface of the table. Install the auxiliary table for attaching straps left **1** and right **2** in place.

Install it at such a location where a clearance of 3 mm is provided between the throat plate **3** and each auxiliary table.

Remove the start switch connector provided as standard at the time of delivery. Then, insert start switch connector **4** which has been mounted on auxiliary table right **2**.

### 3-9. Installing the manual pedal (optional)

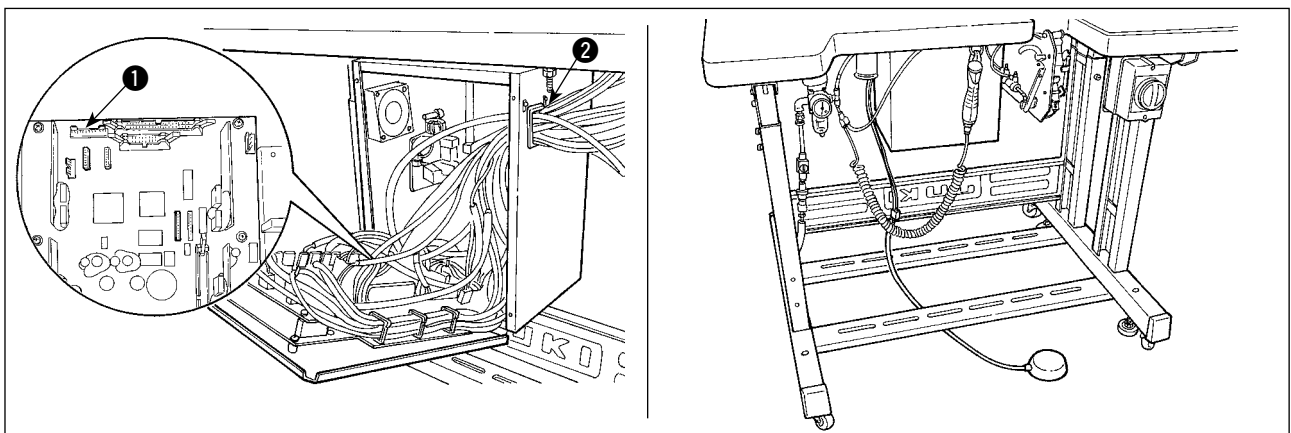

Open the cover of the control box. Insert connector CN88 of the manual pedal into connector **1** CN51 in the control box via the junction cable (40073659). Pass the cable through **2** in the control box.

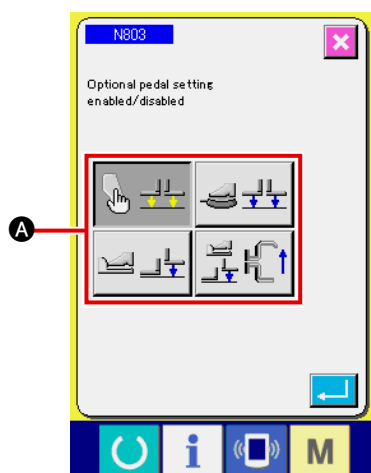

Change the setting to "with optional pedal" on the machine setting N803 **A**.

→ Refer to "[II-2-29. How to set the device](#)", p.98.

### 3-10. Installing the belt loop feeding unit (optional)

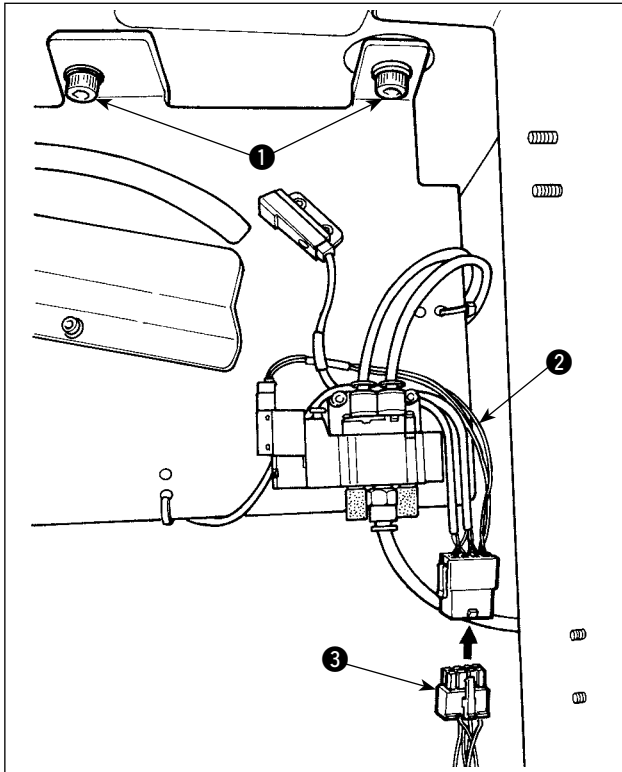

In the case the belt loop feeding unit is to be installed on the machine, the belt loop guide parts installed as standard at the time of delivery have to be removed.

Mount the belt loop feeding unit on the table and fix it by tightening screws ① on the underside of the table.

Connect exclusive junction cable ② to the junction board located behind the main body.

Connect junction cable ② to connector ③ on the feeding unit side.

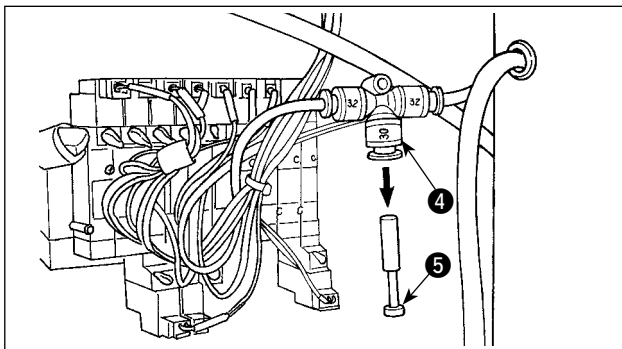

Pull out plug ⑤ from air coupling ④. Then, connect air tube ⑥ on the belt loop feeding unit side to air coupling ④.

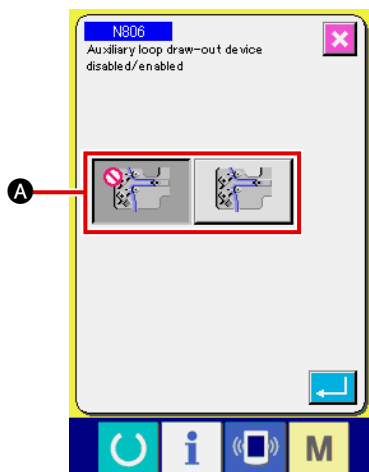
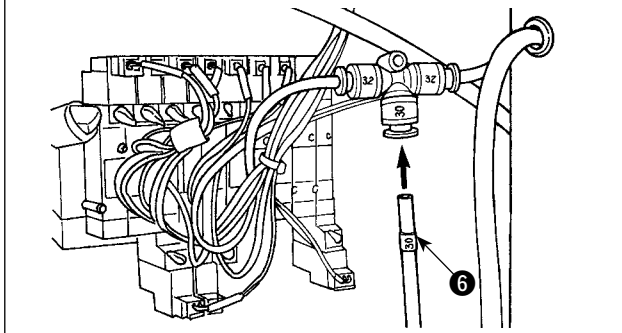

Change the setting to “with belt loop feeding auxiliary unit” on the machine setting N806 **A**.

→ Refer to "[II-2-29. How to set the device](#)", p.98.

### 3-11. Installing the additional marking light (optional)

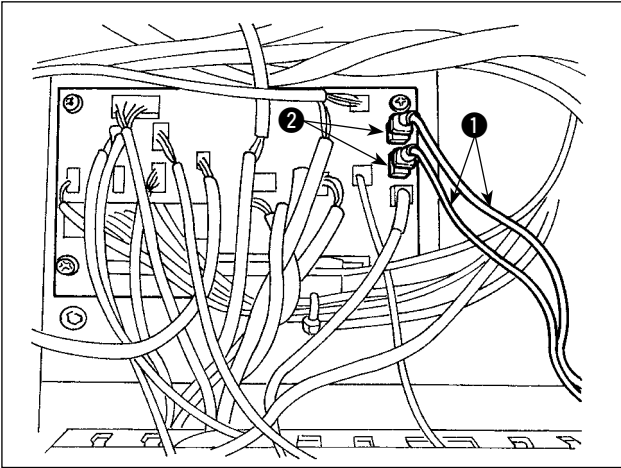

Insert exclusive junction cable ❶ into connector CN85 ❷ of the junction board located behind the main body.

(There are three CN85 connectors including the one used as standard. You may insert the junction cable any of the three connectors.)

## 4. Preparation of the sewing machine

### 4-1. Lubrication



#### CAUTION :

Turn OFF the power before starting the work so as to prevent accidents caused by abrupt start of the sewing machine.

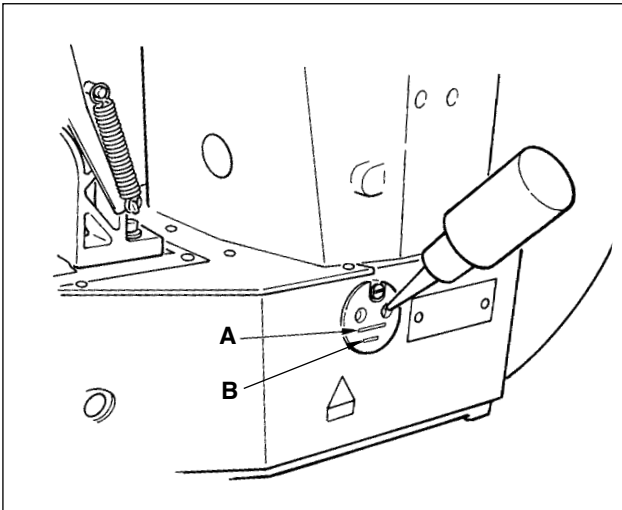

Check that the place between lower line **B** and upper line **A** is filled with oil. Fill there with oil using the oiler supplied with the machine as accessories when oil is short.

\* The oil tank which is filled with oil is only for lubricating to the hook portion.

It is possible to reduce the oil amount when the number of rotation used is low and the oil amount in the hook portion is excessive. (Refer to "[III-1-10. Amount of oil supplied to the hook](#)", p.134.)

1. Do not lubricate to the places other than the oil tank and the hook of **Caution 2** below. Trouble of components will be caused.



2. When using the sewing machine for the first time or after an extended period of disuse, use the machine after lubricating a small amount of oil to the hook portion. (Refer to "[III-1-3. Adjusting the needle-to-hook relation](#)", p.131.)

### 4-2. Attaching the needle



#### CAUTION :

Turn OFF the power before starting the work so as to prevent accidents caused by abrupt start of the sewing machine.

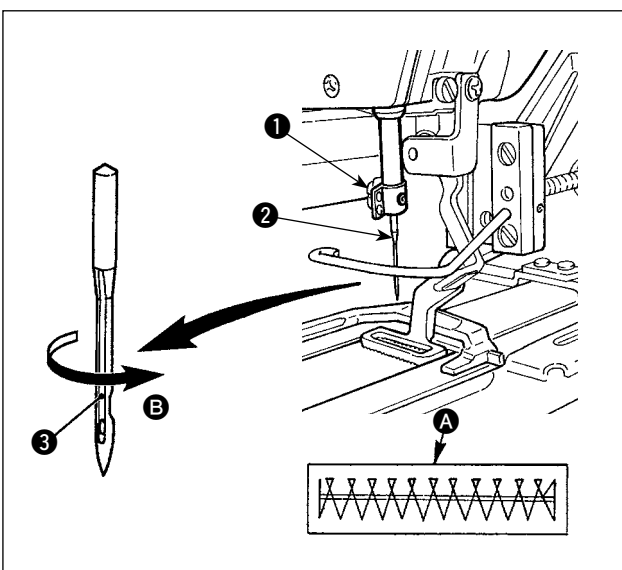

Loosen setscrew **1** and hold needle **2** with the long groove facing **3** toward you. Then fully insert it into the hole in the needle bar, and tighten setscrew **1**.



If the seam shown in **A** is produced, adjust the needle orientation slightly in direction **B**.

### 4-3. Threading the machine head



**CAUTION :**  
Turn OFF the power before starting the work so as to prevent accidents caused by abrupt start of the sewing machine.

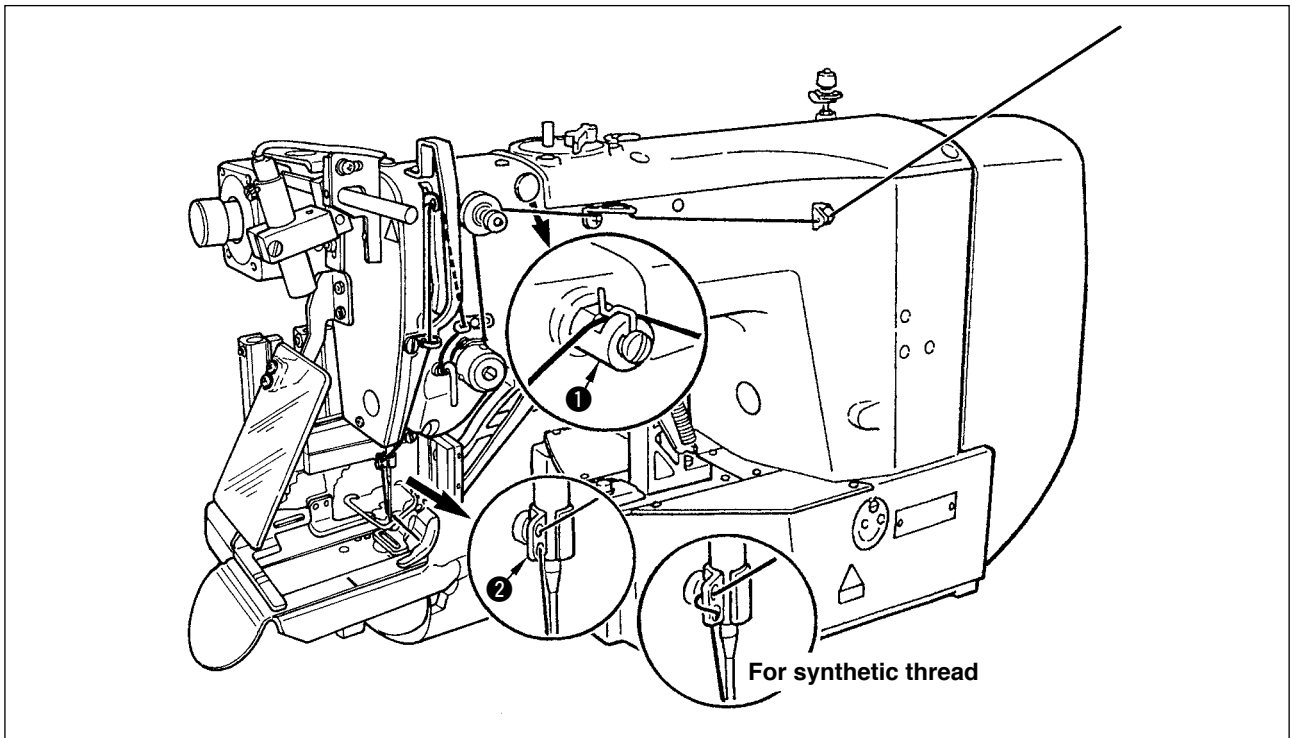

Draw the thread after having threaded the needle so that approximately 4 cm thread trails from the needle eyelet.



When you use silicon oil, pass the thread through silicon-thread thread guide ①. (Silicon-thread thread guide is an optional part.)

### 4-4. Installing and removing the bobbin case



**CAUTION :**  
Turn OFF the power before starting the work so as to prevent accidents caused by abrupt start of the sewing machine.

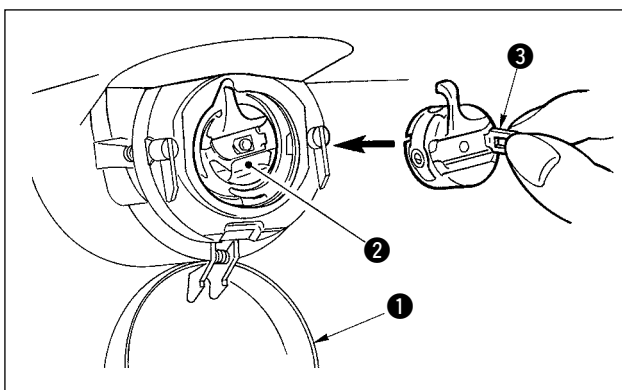

- 1) Open hook cover ①.
- 2) Raise latch ③ of bobbin case ②, and remove the bobbin case.
- 3) When installing the bobbin case, fully insert it into the hook shaft, and close the latch.



If it is not fully inserted, bobbin case ② may slip off during sewing.

## 4-5. Installing the bobbin



### CAUTION :

Turn OFF the power before starting the work so as to prevent accidents caused by abrupt start of the sewing machine.

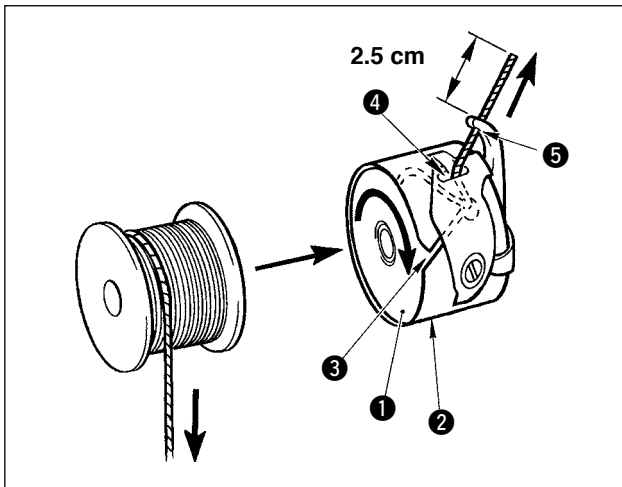

- 1) Set the bobbin ① into bobbin case ② in the direction shown in the figure.
- 2) Pass the thread through thread slit ③ of bobbin case ②, and pull the thread as it is. By so doing, the thread will pass under the tension spring and be pulled out from thread hole ④.
- 3) Pass the thread through thread hole ⑤ of the horn section, and pull out the thread by 2.5 cm from the thread hole.



If the bobbin is installed in the bobbin case orienting the reverse direction, the bobbin thread pulling out will result in an inconsistent state.

## 4-6. Adjusting the thread tension

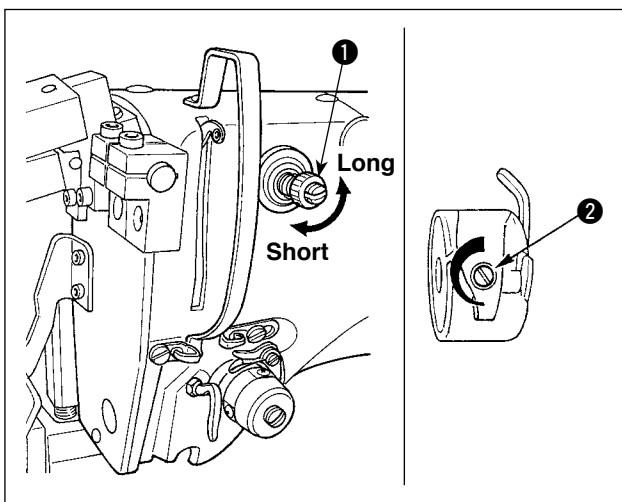

If thread tension controller No. 1 ① is turned clockwise, the length of remaining thread on the needle after thread trimming will be shorter. If it is turned counterclockwise, the length will be longer. Shorten the length to an extent that the thread is not slipped off.

(The standard length of thread remaining on the needle is approximately 4 cm.)

The needle thread tension is adjustable on the operation panel. The bobbin thread tension is adjustable by means of ②.

### Adjusting the needle thread tension

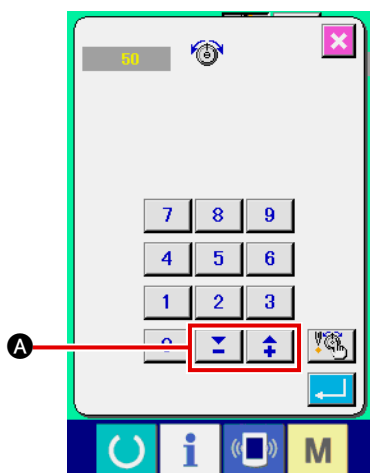

The needle thread tension to be applied to the bartacking sections can be set by means of thread tension setting button A on the operation panel.

#### 4-7. Adjusting the thread take-up spring

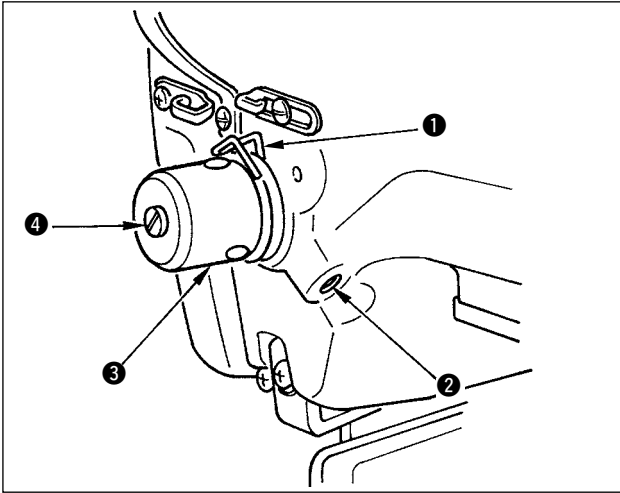

The standard stroke of thread take-up spring ① is 8 to 10 mm, and the pressure at the start is 0.1 to 0.3N.

##### 1) Adjusting the stroke

Loosen setscrew ②, and turn thread tension asm. ③.

Turning it clockwise will increase the moving amount and the thread drawing amount will increase.

##### 2) Adjusting the pressure

To change the pressure of the thread take-up spring, insert a thin screwdriver into the slot of thread tension post ④ while screw ② is tightened, and turn it. Turning it clockwise will increase the pressure of the thread take-up spring. Turning it counterclockwise will decrease the pressure.

#### 4-8. Example of the thread tension

When using the sewing machine for the first time, adjust the thread tension referring to the table below.

Thread	Material	Needle thread tension setting	Thread take-up spring moving amount [Thread drawing amount]	Strength
Polyester spun thread #50	Wool	50 to 55	10mm [13mm]	0.2N
Polyester filament thread #50	Wool	30 to 35	10mm [13mm]	0.1N



## 5. Operating the sewing machine

### 5-1. Emergency stop switch

#### (1) Method for operating the emergency stop switch

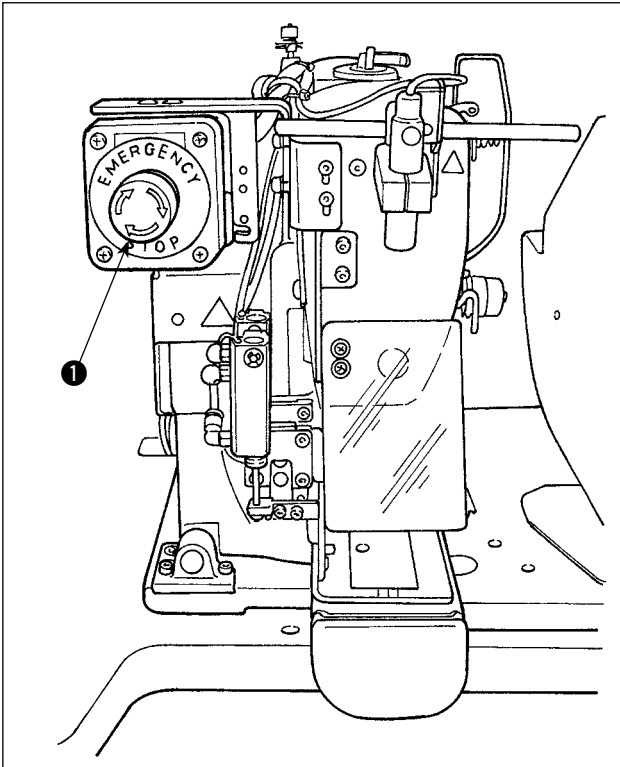

Emergency stop switch ❶ is mounted on the upper left section of the sewing machine head.

Emergency stop switch ❶ is turned ON by strongly pressing in the red button. It is turned OFF by turning it counterclockwise.

If you turn ON emergency stop switch ❶ while the machine is in operation, the power is turned OFF to cause the machine to stop operation.



**If you turn OFF emergency stop switch ❶ with the power switch remained ON, the power is re-turned ON. Take care of abrupt re-turn ON of the power.**

To turn OFF the power for any purpose other than an emergency stop, operate the power switch.

#### (2) Precautions with the emergency stop switch

When emergency stop switch ❶ stays ON, the sewing machine cannot be powered up even if you turn ON/OFF the power switch. The work clamp foot of the sewing machine may depress the loop clamp or the belt loop loosening rod according to the operation timing of emergency stop switch ❶. If this phenomenon occurs, turn OFF the power to the sewing machine and manually lift the work clamp foot of the sewing machine to move it so as to avoid interference. Then, re-turn ON the power to the sewing machine.

## 5-2. Winding a bobbin

### (1) To wind a bobbin while the sewing machine is performing sewing

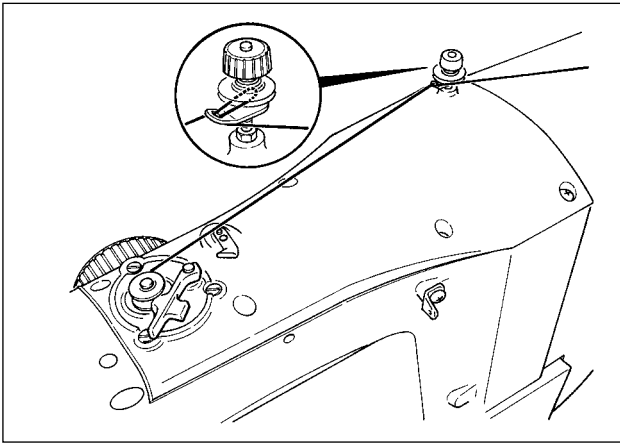

Thread the bobbin winder and wind the bobbin thread onto the bobbin as illustrated in the figure.

### (2) To wind a bobbin independently

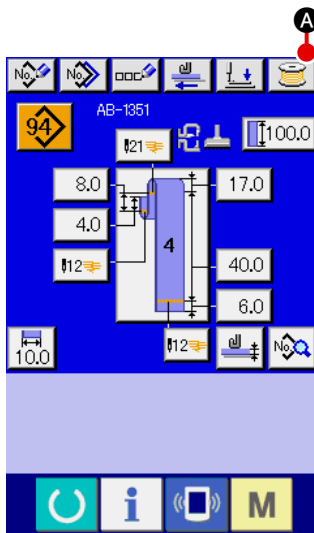

In the case you only want to carry out bobbin winding on the sewing machine, unthread the needle and remove the bobbin from the hook.

#### ① Displaying the bobbin thread winding screen

Press bobbin winding button  **A** on the belt loop data input screen (blue), and the bobbin winding screen appears on the screen.

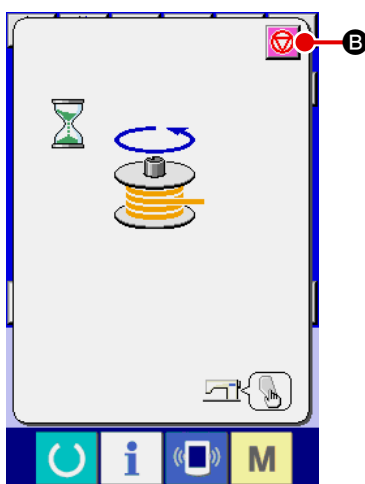

#### ② Starting bobbin winding

Press the start switch, and the sewing machine rotates to start bobbin winding.

#### ③ Stopping the sewing machine



Press stop button  **B**, and the sewing machine stops and returns to the normal mode. If you press the start switch again during bobbin winding, the sewing machine stops under the bobbin winding mode. If you press the start switch again in this state, the sewing machine re-starts bobbin winding. Use this operating procedure when you want to wind thread on two or more bobbins.



The bobbin winding will not start immediately after turning the power ON. To activate the bobbin winding function, set a pattern number or the like first, then press the set ready key  to invoke the sewing screen. In this state, the bobbin winding function is enabled.

## 5-3. Thread clamp device

Trouble of sewing (slip-off of needle thread, stitch skipping, or stain of needle thread) at the time of high-speed start can be prevented with the thread clamp device.

The thread clamp device will operate when the thread clamp button has been selected , but it will not operate when the thread clamp button has not been selected .

Changeover of ON/OFF motion is performed with  key. When the thread grasping device is in the OFF state, the sewing machine is automatically set to the soft-start mode.



1. When memory switch **U035** is "1" (prohibited), the thread clamp does not work. Furthermore, the thread clamp key  will not be displayed.
2. Memory switch, refer to "II-2-28. How to change the memory switch data", p.93.

### \* Matters that demand special attention when using the needle thread clamp

- (1) In case of with the needle thread clamp (motion), make shorter the length of needle thread remaining on the needle at the sewing start for use. When the length of needle thread is lengthened, needle thread on the wrong side of material is apt to protrude. In addition, when the length is excessively lengthened, the end of needle thread held by the needle thread clamp may be rolled in the seams.

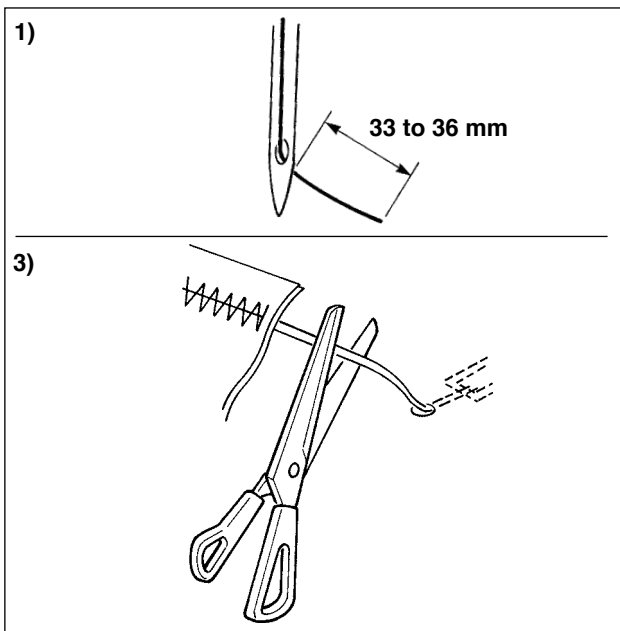

- 1) In case of with the needle thread clamp, the standard of the length of needle thread is 33 to 36 mm.
- 2) When needle thread is long after replacing thread or the like or sewing while holding needle thread by hand, turn OFF the THREAD CLAMP  key.
- 3) When the needle thread held with the thread clamp is rolled in the seams, do not draw the material forcibly and cut the connecting needle thread with the scissors or the like. The seams are not damaged since it is the needle thread at the sewing start.

- (2) It is possible to adjust needle thread shorter by making the needle thread clamp work while holding the stabilized sewing at the start of sewing and the gathering (bird's nest) of needle thread on the wrong side of material can be lessened. However, for the pattern which the stitch length for neatly rolling in needle thread is short, needle thread may protrude from the wrong side of material. Select with/without thread clamp referring to the item below.

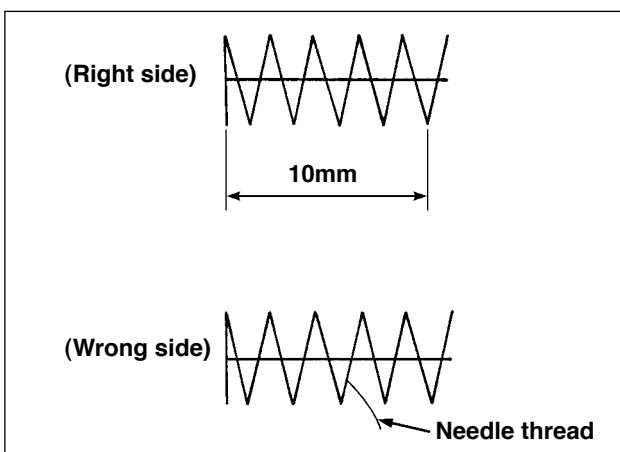

When the sewing length is short (less than approximately 10 mm), the end of needle thread may protrude like beard even when adjusting needle thread shorter.

## 5-4. Placing a belt loop

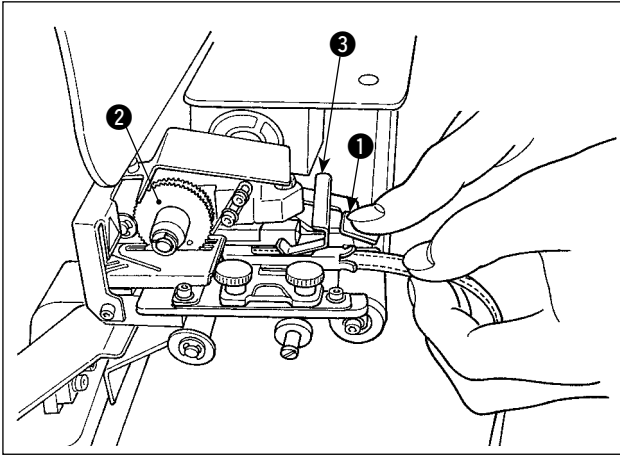

Press down multi-layered part detecting bracket ③ and lever ① of the gear of the loop draw-out device to put the belt loop into the guide until it is placed under gear ②.



**When you route the belt loop under the gear, insert it until it appears from the belt loop cutting knife.**

\* In the case the sewing machine is ON, when multi-layered part detecting bracket ③ is pushed up, the gear is rotated by the motor to feed the belt loop.

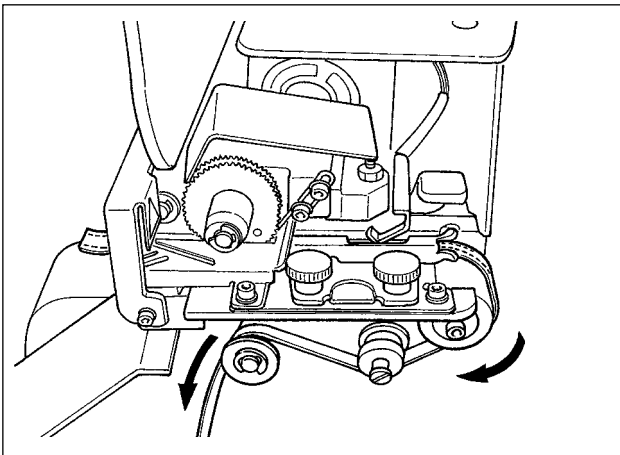

Route the belt loop in the direction of the arrow. Finally, route the belt loop in the guide roller section on the table to allow it to trail downward.



**Position the belt loop below the guide roller so as to prevent it from being hitched or being applied with an excessive resistance at the time of belt loop feeding.**

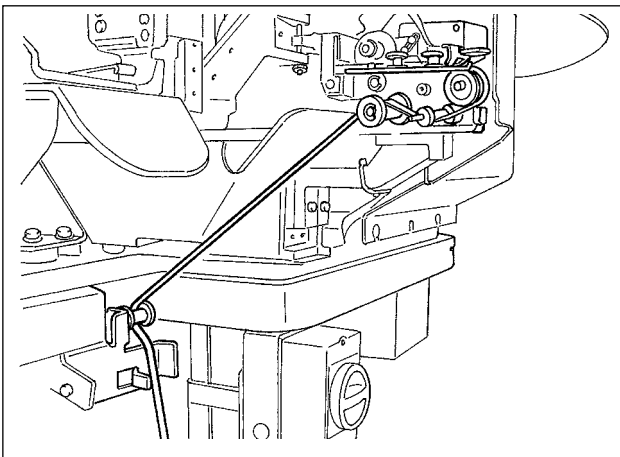

In the case the optional belt loop feeding unit is to be mounted on the sewing machine, route the belt loop as illustrated in the figure at left.



**The belt loop feeding unit is provided with a capability of detecting two different errors; one is the case the belt loop has knots and the other is the case the belt loop cannot be fed due to an excessive resistance.**

## 5-5. Adjusting the belt loop tension

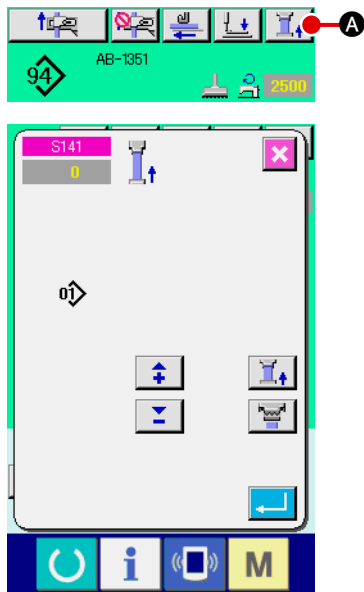

When you have changed the belt loop, you need to re-adjust the belt loop tension without exceptions.

Press the belt loop tension button  **A** on the sewing screen.

The more the belt loop tension is adjusted in a negative direction, the less the belt loop tension becomes. (The belt loop tension can be set and stored in memory on a sewing-pattern by sewing-pattern basis.)

As a guide, adjust the belt loop tension so that the entire length of the belt loop fed from the belt loop feeding section and clamped at the belt loop clamping section is shorter than the entire belt loop length displayed when selecting a sewing pattern by approximately 1 mm.



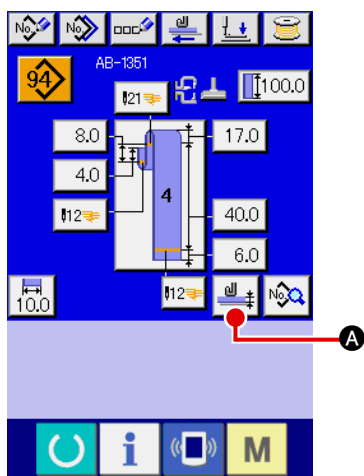

If the sewing machine is operated under a high belt loop tension, the entire length of the belt loop fed becomes shorter than required. In this case, problems such that the belt loop cannot be sewing at the predetermined length or that the cut end of the belt loop is not straight can occur. To prevent such problems, adjust the belt loop tension adequately.

## 5-6. Setting the belt loop thickness



When you use a new belt loop, you need to set the belt loop thickness without exceptions. If the belt loop has multi-layered parts (splices), thickness of the multi-layered part has also to be set.

Press belt loop thickness teaching button  **A** on the operation panel screen.

Route the belt loop to be used in the predetermined manner and press belt loop feeding button  **B**. The belt loop is fed as long as the feed key is held pressed. As long as you keep the feed key held pressed, the belt loop is fed. Be sure to press the enter button  **C** after having passed both the normal-thickness part and multi-layered part of the belt loop under the multi-layered part detecting section.

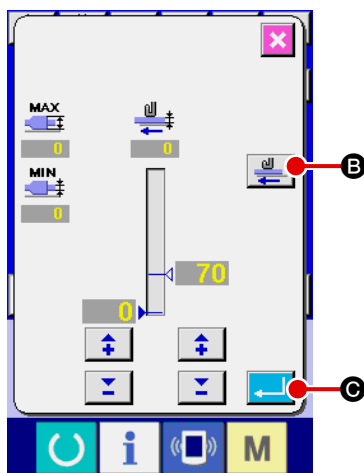

1. If the belt loop thickness is smaller than the predetermined value, the belt loop presence/absence detector of the belt loop drawing device may determine that the belt loop is absent even if the belt loop is present. If the aforementioned error occurs, operate the sewing machine with the belt loop presence/absence detecting function disabled.

2. As a guide, the belt loop thickness is 1 to 1.8 mm. If the belt loop thickness exceeds the aforementioned range, the belt loop clamping section and the work clamp foot of the sewing machine can interfere with each other. To prevent this, be sure to perform trial stitching in prior to confirm no interference between them. Then, start sewing.

## 5-7. Method for changing the belt loop width

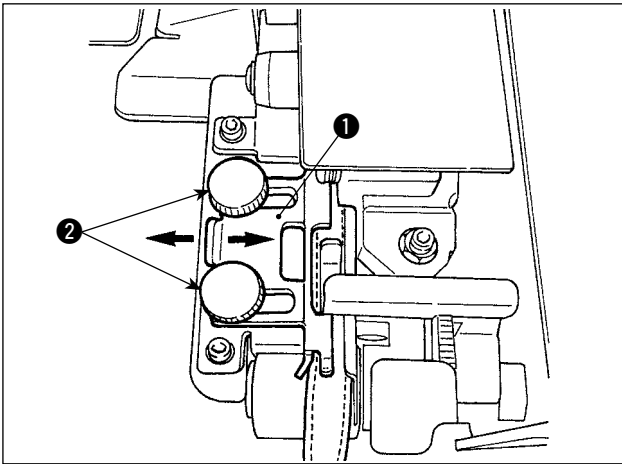

- 1) When you want to change the belt loop width, loosen two screws ② of belt loop guide ① to adjust the guide width to fit the belt loop width.

Adjust so that the belt-loop passes through the belt-loop guide smoothly with no excessive lateral space between the guide and the belt loop, with guide ① pressed lightly against the belt loop.

Check that the top end of the belt loop guide matches the belt loop width.

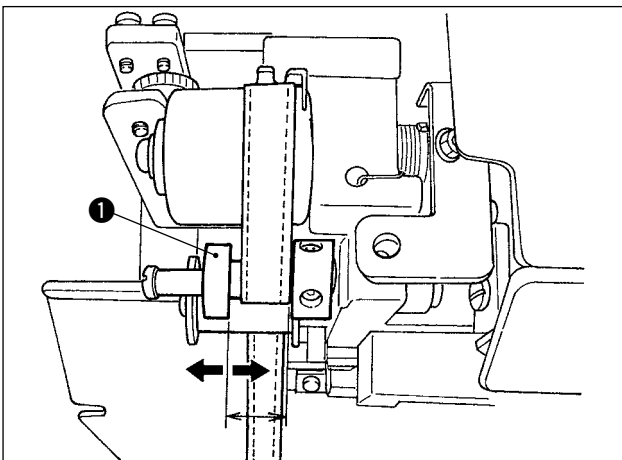

- 2) Adjust the position of guide ① according to the belt loop width.

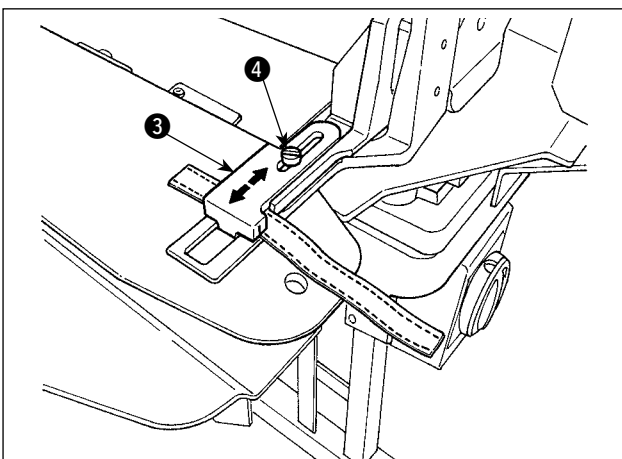

- 3) Loosen setscrew ④ of the belt loop clamp. Adjust the position of loop clamp, upper ③ according to the belt loop width.

**The width of the belt loop guide section and that of the belt loop clamping section should be adjusted so that the belt loop smoothly pass through and that no widthwise play exists. If there is an excessive widthwise play, the belt loop attaching location can vary.**



- 4) Enter a value of belt loop width into belt loop width setting section A on the operation panel screen. At the same time, change the dimensions of a seam for attaching a belt loop. Refer to "[II-2-6. How to change the belt loop length](#)", p.39 for the method for changing the seam dimensions.

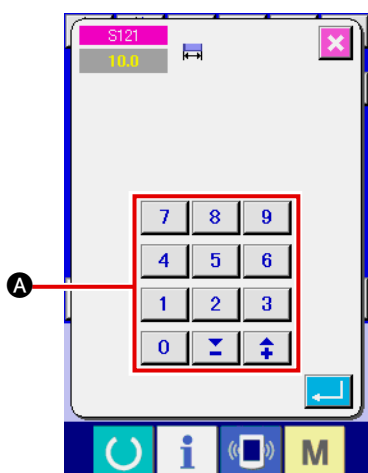

**If the bartacking width of which is extremely wider than the bartacking width setting specified through the operation panel is sewn, the garment-body presser and the belt-loop clamp can interfere with each other (error No. M596). If the alarm is given, change the bartacking width setting to decrease the bartacking width.**



## 5-8. Method for adjusting the workpiece stopper

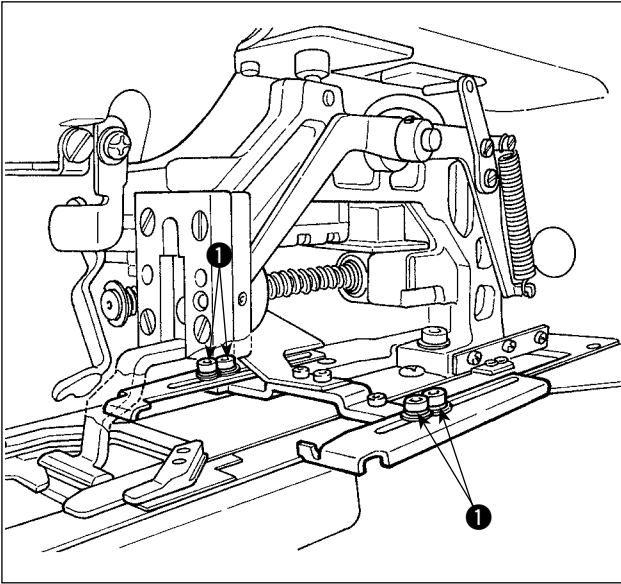

Loosen screws ❶ and adjust the position of the workpiece stopper according to the belt loop attaching location on the garment body.



In the case the workpiece stopper is adjusted to a position which is behind the needle entry point by 17 mm or more, the risk of catching the garment body between the throat plate and the workpiece stopper can be posed. In the case the workpiece stopper position has to be adjusted to 17 mm or more away from the needle entry toward far side, the custom-made material stopper should be used to avoid the problem.

## 5-9. Start switch



### CAUTION :

When you press the start switch, the garment-body presser comes down. At the same time, the loop clamp moves toward the sewing machine at a high speed. Take added care to keep your hands away from the loop clamp during work.

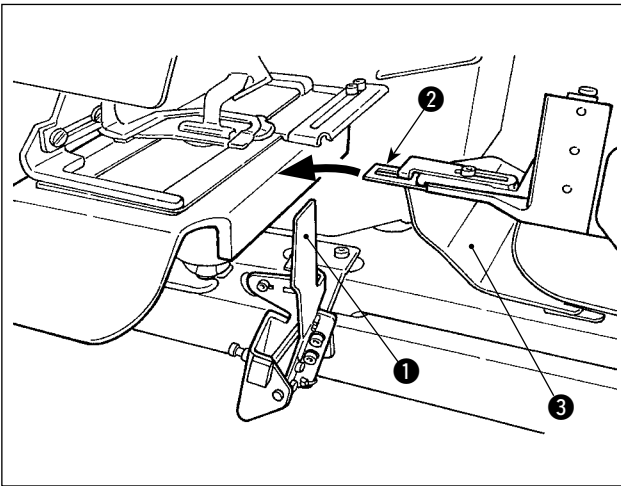

Once you have completed preparation for sewing, you can bring the sewing machine into operation by pressing start switch ❶.

When the loop clamp ❷ has clamped the belt loop, operation of the start switch ❶ will be accepted.

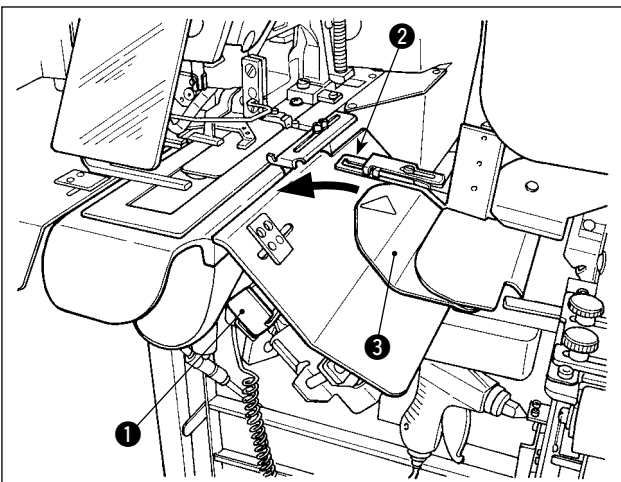

1. Operate the sewing machine taking care not to allow your hands move above safety cover ❸ since the hands can interfere with the loop clamp.

2. If you do not keep the start switch held pressed for a sufficiently long time, sewing will be interrupted. Be sure to keep the start switch fully held pressed.

3. You may also press the start switch while the belt loop clamp clamps the belt loop and travels to the standby position after the completion of sewing. In that case, the belt-loop clamp will not stop at the standby position but will move directly to the sewing position to start the next sewing. Be sure to exercise added care during this procedure.



## II. OPERATION (OPERATION PANEL)

### 1. Introduction

#### 1) Type of sewing data handled by the IP-420

Pattern name	Description
Vector format data	File that extension is “.VDT” Read from media. Max. 999 patterns can be used.
Sewing data	File that extension is “.EPD” Read from media. Max. 999 patterns can be used.

#### 2) Folder structure of the media

Store each file in the directories below of the media.

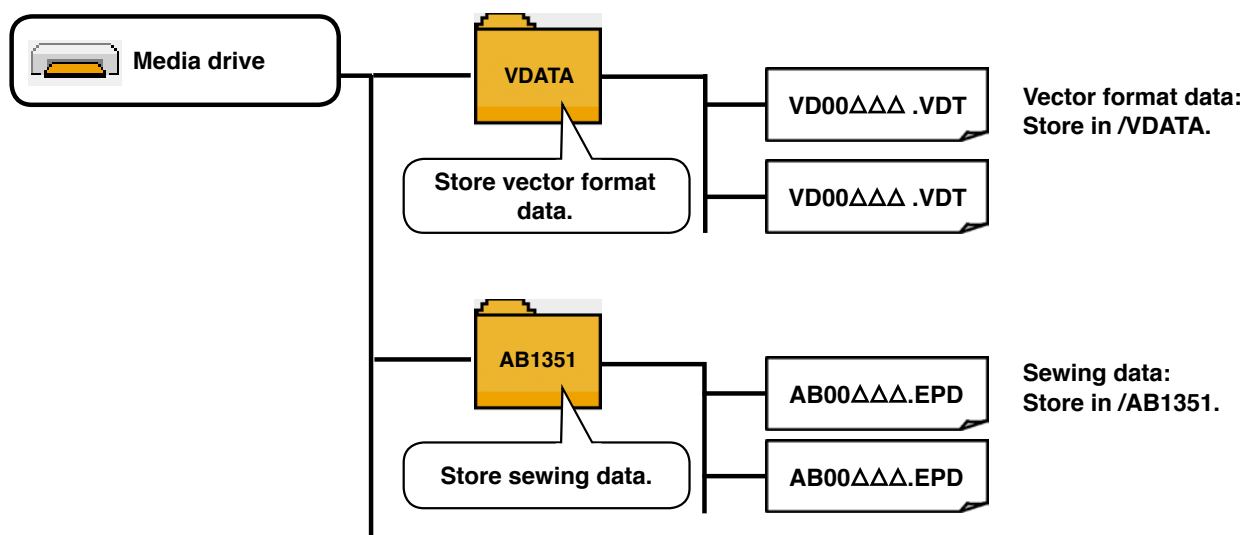

Data that are not stored in the directories above cannot be read. So, be careful.



### 3) CompactFlash (TM)

#### ■ Inserting the CompactFlash (TM)

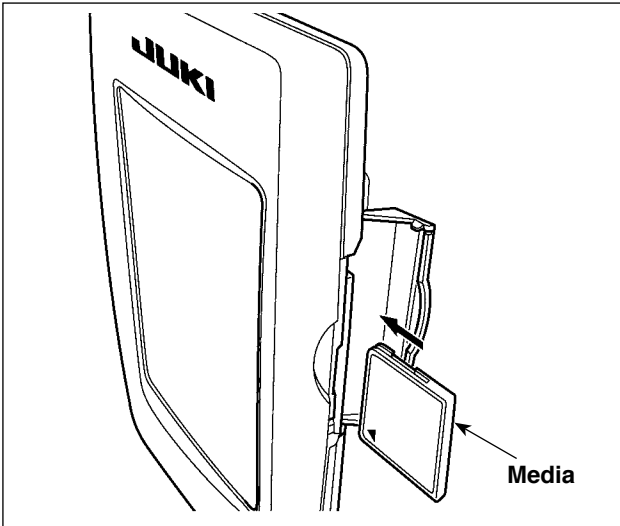

- 1) Turn the label side of the CompactFlash (TM) to this side (place the notch of the edge to the rear.) and insert the media that has a small hole to the rear.
- 2) After completion of setting of the media, close the cover. By closing the cover, it is possible to access. If the media and the cover come in contact with each other and the cover is not closed, check the following matters.
  - Check that the media is securely pressed until it goes no further.
  - Check that the inserting direction of the media is proper.



1. When the inserting direction of the media is wrong, panel or media may be damaged.
2. Do not insert any item other than the CompactFlash (TM).
3. The media slot in the IP-420 accommodates to the CompactFlash (TM) of 2GB or less.
4. The media slot in the IP-420 supports the FAT16 which is the format of the CompactFlash (TM). FAT32 is not supported.
5. Be sure to use the CompactFlash (TM) which is formatted with IP-420. For the formatting procedure of the CompactFlash (TM), see "[II-2-32. Performing formatting of the media](#)", p.106.

#### ■ Removing the CompactFlash (TM)

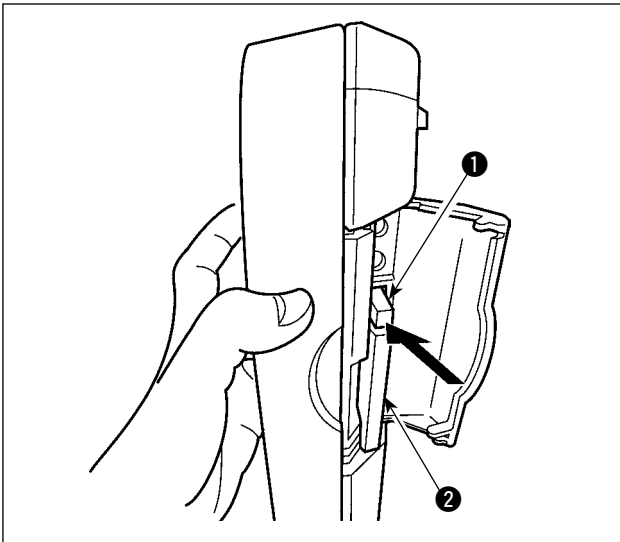

- 1) Hold the panel by hand, open the cover, and press the media removing lever ①. The media ② is eject.



**When the lever ① is strongly pressed, the media ② may be broken by protruding and falling.**

- 2) When the media ② is drawn out as it is, removing is completed.

#### 4) USB port

##### ■ Inserting a device into the USB port

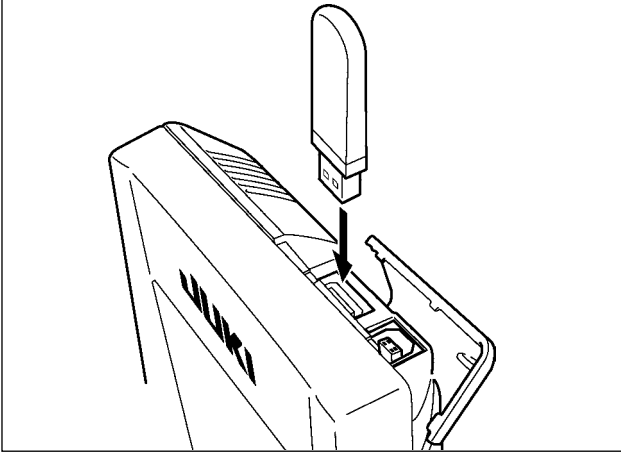

Slide the top cover and insert the USB device into the USB port. Then, copy data to be used from the USB device onto the main body.

After completion of copying the data, remove the USB device.

##### ■ Disconnecting a device from the USB port

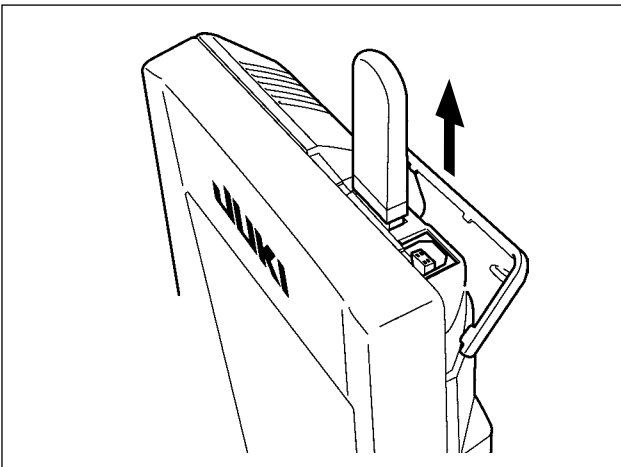

Remove the USB device. Put the cover back in place.

##### **Cautions when using the media:**



- Do not wet or touch it with wet hands. Fire or electric shock will be caused.
- Do not bend, or apply strong force or shock to it.
- Never perform disassembling or remodeling of it.
- Do not put the metal to the contact part of it. Data may be disappeared.
- Avoid storing or using it in the places below.

Place of high temperature or humidity / Place of dew condensation

Place with much dust / Place where static electricity of electrical noise is likely to occur

① Precautions to be taken when handling USB devices

- Do not leave the USB device or USB cable connected to the USB port while the sewing machine is in operation. The machine vibration can damage the port section resulting in loss of data stored on the USB device or breakage of the USB device or sewing machine.
- Do not insert/remove a USB device during reading/writing a program or sewing data. It may cause data breakage or malfunction.
- When the storage space of a USB device is partitioned, only one partition is accessible.
- Some type of the USB device may not be properly recognized by this sewing machine.
- JUKI does not compensate for loss of data stored on the USB device caused by using it with this sewing machine.
- When the panel displays the communication screen or pattern data list, the USB drive is not recognized even if you insert a medium into the slot.
- For USB devices and media such as CF cards, only one device/medium should be basically connected/inserted to/into the sewing machine. When two or more devices/media are connected/inserted, the machine will only recognize one of them. Refer to the USB specifications.
- Insert the USB connector into the USB terminal on the IP panel until it will go no further.
- Do not turn the power OFF while the data on the USB flash drive is being accessed.

② USB specifications

- Conform to USB 1.1 standard
- Applicable devices \*1\_\_\_ Storage devices such as USB memory, USB hub, FDD and card reader
- Not-applicable devices\_\_\_ CD drive, DVD drive, MO drive, tape drive, etc.
- Format supported \_\_\_\_\_ FD (floppy disk) FAT 12  
Others (USB memory, etc.), FAT 12, FAT 16, FAT 32
- Applicable medium size \_ FD (floppy disk) 1.44MB, 720kB  
Others (USB memory, etc.), 4.1MB ~ (2TB)
- Recognition of drives \_\_\_ For external devices such as a USB device, the device which is recognized first is accessed. However, when a medium is connected to the built-in media slot, the access to that medium will be given the highest priority. (Example: If a medium is inserted into the media slot even when the USB memory has already been connected to the USB port, the medium will be accessed.)
- Restriction on connection \_ Max. 10 devices (When the number of storage devices connected to the sewing machine has exceeded the maximum number, the 11th storage device and beyond will not be recognized unless they are once disconnected and re-connected. )
- Consumption current \_\_\_ The rated consumption current of the applicable USB devices is 500 mA at the maximum.

\*1: JUKI does not guarantee operation of all applicable devices. Some device may not operate due to a compatibility problem.

## 2. Method for using the operation panel

### 2-1. Name of each section of IP-420

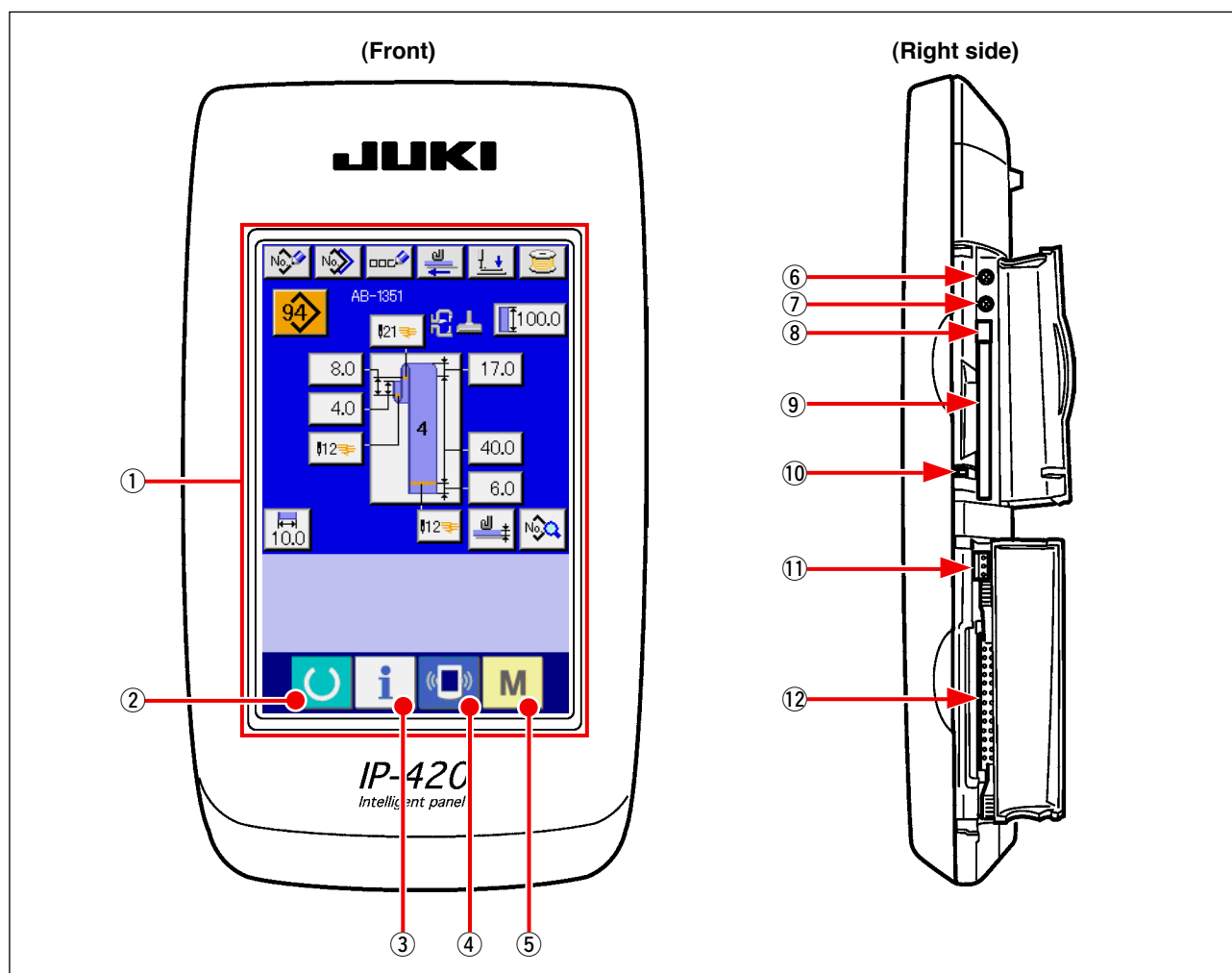

① Touch panel · LCD display section

②  SET READY key → Changeover of the data input screen and the sewing screen can be performed.

③  INFORMATION key → Changeover of the data input screen and the information screen can be performed.

④  COMMUNICATION key → Changeover of the data input screen and the communication screen can be performed.

⑤  MODE key → Changeover of the data input screen and the mode changeover screen which performs various detail settings can be performed.

⑥ Contrast control

⑦ Brightness control

⑧ CompactFlash (TM) eject button

⑨ CompactFlash (TM) slot

⑩ Cover detection switch

⑪ Connector for external switch

⑫ Connector for control-box connection

## 2-2. Buttons to be used in common

The buttons which perform common operations in each screen of IP-420 are as follows:



CANCEL button

→ This button closes the pop-up screen.  
In case of the data change screen, the data being changed can be cancelled.



ENTER button

→ This button determines the changed data.



UP SCROLL button

→ This button scrolls the button or the display in the upward direction.



DOWN SCROLL button

→ This button scrolls the button or the display in the downward direction.



RESET button

→ This button performs the release of error.



NUMERAL INPUT button

→ This button displays ten keys and input of numerals can be performed.



CHARACTER INPUT button

→ This button displays the character input screen.  
→ Refer to “[II -2-10. How to name a belt loop pattern number](#)”, p.49.



PRESSER LOWERING button

→ Presser is lowered, and the presser lowering screen is displayed. To lift presser, press presser lift button displayed in the presser lowering screen.



Bobbin winder button

→ Bobbin thread winding is performed.  
→ Refer to “[I -5-2. Winding a bobbin](#)”, p.21.

## 2-3. Basic operation of IP-420



### ① Turn ON the power switch

When the power is turned ON first, the language selection screen is displayed. Set the language you use. (It is possible to change with Memory switch **U239**).

**Important** When ending the selection screen with **CANCEL** button **X** or **ENTER** button **↵** without performing the language selection, the language selection screen is displayed whenever the power is turned ON.

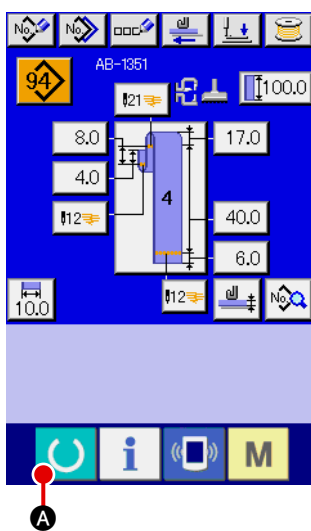

### ② Press SET READY key to move on to the sewing ready state

When SET READY key **A** is pressed, the back color of LCD display is changed to green, and the sewing machine is set to the sewing possible state.

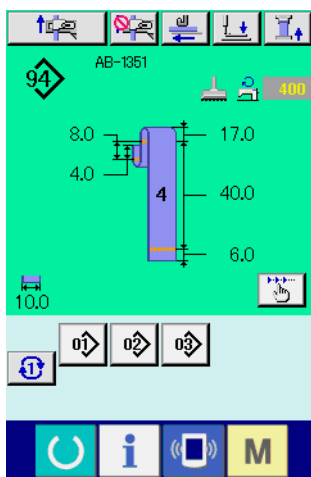





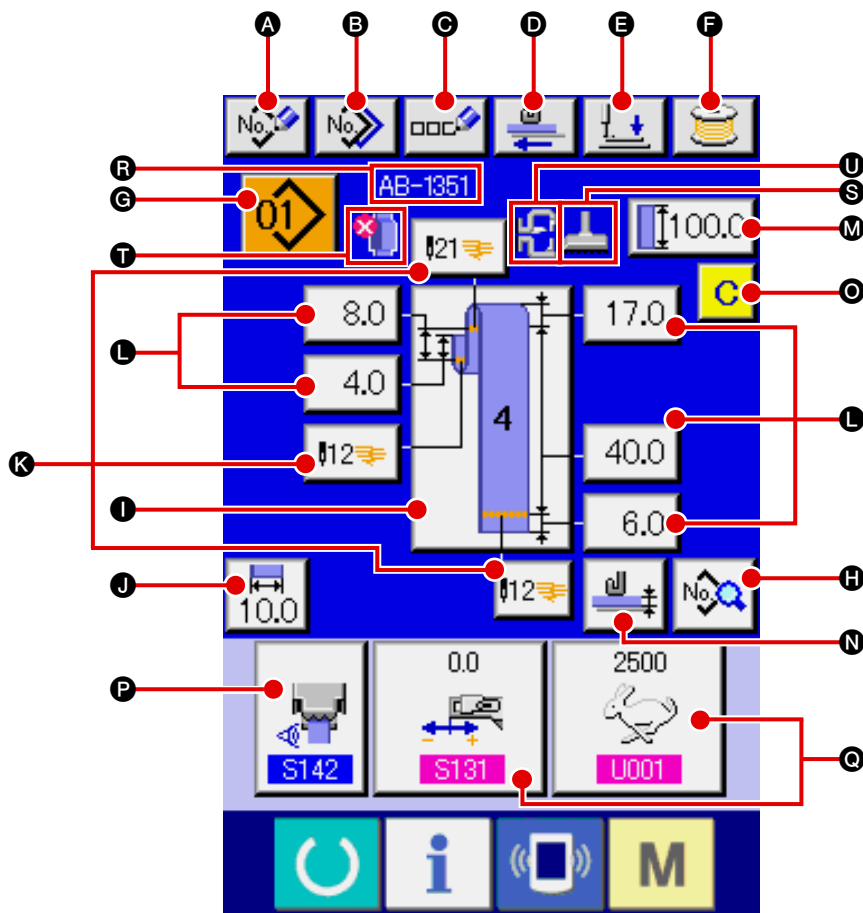

## 2-4. Liquid crystal display section when the belt loop individual sewing is selected

### (1) Belt loop individual sewing data entry screen



Symbol	Name of button	Description
<b>A</b>	New pattern creating button	Displays the new belt loop pattern number creation screen to allow registration of new pattern data. → Refer to " <a href="#">II-2-9. How to register a new belt loop pattern number</a> ", p.47.
<b>B</b>	Copy button	Displays the copy source belt loop pattern number selection screen to allow copying of pattern data. → Refer to " <a href="#">II-2-12. How to copy a belt loop pattern number</a> ", p.52.
<b>C</b>	Character entry button	Displays the belt loop individual sewing character entry screen to allow entry of the name of pattern data. → Refer to " <a href="#">II-2-10. How to name a belt loop pattern number</a> ", p.49.
<b>D</b>	Feed button	Insert a belt loop into the belt loop feeder unit and press this button to feed the belt loop.
<b>E</b>	Presser lowering button	The machine lowers the garment body presser and the work clamp foot and displays the presser lowering screen. → Refer to " <a href="#">II-2-7. How to lower the garment body presser and the work clamp</a> ", p.42.
<b>F</b>	Bobbin winding button	Displays the bobbin winding screen to allow the machine to wind a bobbin. → Refer to " <a href="#">I-5-2. Winding a bobbin</a> ", p.21.

Symbol	Name of button	Description
Ⓔ	Pattern number list button	Displays the belt loop pattern number list screen to allow selection of pattern data. → Refer to " <a href="#">II-2-11. How to select a belt loop pattern number</a> ", p.50.
Ⓕ	Sewing data list button	Displays the sewing data list screen. Detailed sewing data which is not displayed on the entry screen can be selected to edit sewing data.
Ⓖ	Sewing shape button	Displays the sewing shape setting screen. → Refer to " <a href="#">II-2-5. How to change over the sewing shape</a> ", p.38.
Ⓙ	Belt loop width button	Displays the belt loop width setting screen.
Ⓚ	Bartacking button	Displays the LK individual data entry screen to shift to the bartacking setting mode. The number of buttons to be displayed on the screen differs with the sewing shape. The number of stitches and the types of sewing shape (linear bartacking or zigzag bartacking) will be displayed on the button. → Refer to " <a href="#">II-2-16. How to carry out the bartacking setting</a> ", p.59.
Ⓛ	Belt loop length button	Displays the belt loop length setting screen. The buttons are displayed according to the sewing shape and the settable belt loop length that can be set. The number of buttons to be displayed on the screen differs with the sewing shape.
Ⓜ	Belt loop length entry button	Displays the belt loop length entry screen.
Ⓝ	Belt loop thickness teaching button	Displays the belt loop thickness teaching screen. → Refer to " <a href="#">II-2-13. Belt loop teaching function</a> ", p.53.
Ⓞ	Belt loop multi-layered part clear button	Displays the confirmation screen to allow you to determine whether or not the detected multi-layered part of the belt loop (or detected no belt loop state) may be cleared.
Ⓟ	Sewing data customization button	Displays the sewing data setting screen specified on the customization setting screen of the data entry screen.
Ⓠ	Sewing data / adjustment data customization screen	Displays the sewing data setting screen or the adjustment data setting screen specified on the customization setting screen of the data entry screen.





Symbol	Name of image	Description
Ⓡ	Name of belt loop individual sewing data	Displays the name entered in the belt loop individual sewing data which is currently selected.
Ⓢ	Frame of the work clamp foot	Displays the work clamp foot for linear bartacking or that for zigzag bartacking which is currently selected.  : Work clamp foot for linear bartacking  : Work clamp foot for zigzag bartacking
Ⓣ	Information on the multi-layered part of belt loop	The detected multi-layered part of the belt loop will be displayed.  : No belt loop  : Multi-layered part of belt loop is detected
Ⓤ	Garment body presser	Displays presence/absence of the additional clamp for the currently-selected garment body presser.  : Additional clamp is present.  : Additional clamp is absent.

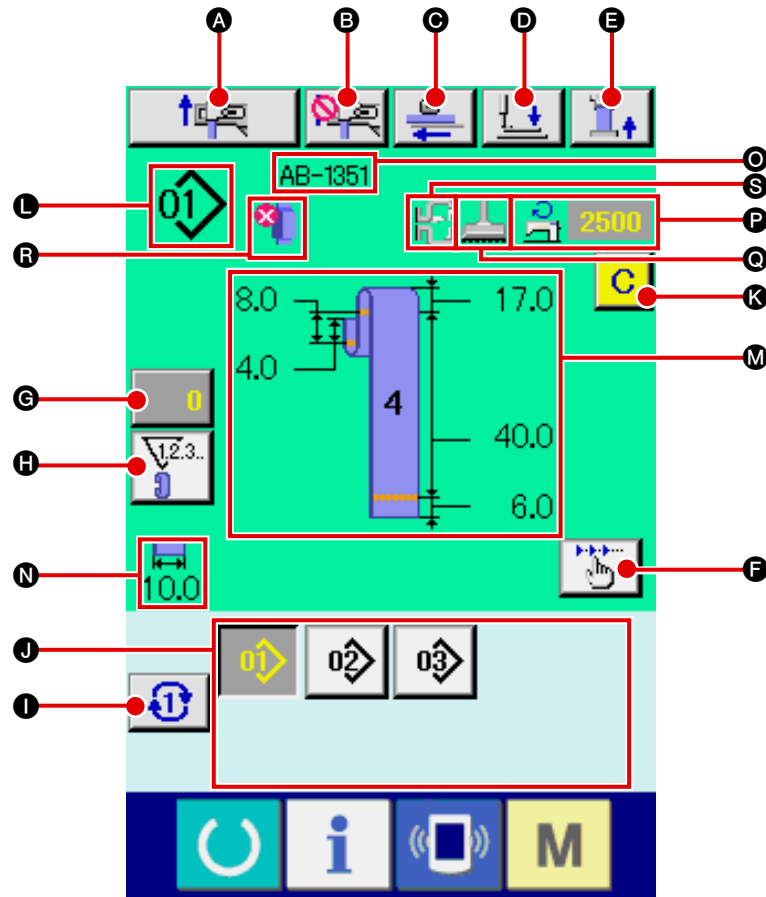







## (2) Belt loop individual sewing screen





Symbol	Name of button	Description
<b>A</b>	Setback operation button	Carries out the setback operation.
<b>B</b>	Next belt loop catching cancel button	The machine carries out prohibition (cancel) or reset of belt loop catching for the next sewing. → Refer to " <a href="#">II-2-15. Function of canceling grasping of a belt loop for the next sewing</a> ", p.58.
<b>C</b>	Feed button	When this button is pressed with a belt loop inserted into the belt loop feeder, the feeder feeds the belt loop. It should be remembered, however, this button cannot be pressed while the sewing machine is engaged in sewing or carries out setback operation.
<b>D</b>	Presser lowering button	The machine lowers the garment body presser and the work clamp foot and displays the presser lowering screen. It should be remembered, however, this button cannot be pressed while the sewing machine is engaged in sewing or carries out setback operation. → Refer to " <a href="#">II-2-7. How to lower the garment body presser and the work clamp foot</a> ", p.42.
<b>E</b>	Belt loop tension button	Displays the belt loop tension entry screen. At this time, the start switch action will be prohibited.
<b>F</b>	Step operation button	Displays the step operation selection screen and shifts to the step operation mode. It should be remembered, however, this button cannot be pressed while the sewing machine performs the setback operation. → Refer to " <a href="#">II-2-14. How to carry out the step operation</a> ", p.55.
<b>G</b>	Counter value change button	Displays the current counter value on the button. When this button is pressed, the counter value change screen is displayed. → Refer to " <a href="#">II-2-8. Using counter</a> ", p.43.

Symbol	Name of button	Description
H	Counter changeover button	<p>Bartacking counter display/belt loop counter display/bobbin thread counter display can be changed over.</p> <p>The button is displayed only in the case two or more of the aforementioned counters are in the ON state.</p> <p> : Bartacking counter</p> <p> : Belt loop counter</p> <p> : Bobbin thread counter</p> <p>→ Refer to "<a href="#">II-2-8. Using counter</a>", p.43.</p>
I	Direct-pattern next page button	Displays belt loop pattern numbers registered on the next page on J section.
J	Direct pattern button	<p>Displays the belt loop pattern number specified on the direct pattern selection screen.</p> <p> <b>Be aware that a press on this button activates the work clamp foot and the garment-body presser.</b></p>
K	Belt loop multi-layered part clear button	Displays the confirmation screen to allow you to determine whether or not the detected multi-layered part of the belt loop (or detected no belt loop state) may be cleared.

Symbol	Name of image	Description
L	Belt loop pattern number	Displays the belt loop pattern number which is currently selected.
M	Belt loop pattern description	Displays the description (sewing shape, dimensions) of the belt loop pattern to be sewn.
N	Belt loop width	Displays the belt loop width which is currently set.
O	Name of belt loop individual sewing data	Displays the name entered in the belt loop individual sewing data which is currently selected.
P	Number of revolutions of sewing machine	Displays the number of revolutions (set value) of the bartacking pattern which is being sewing.
Q	Frame of the work clamp foot	<p>Displays the work clamp foot for linear bartacking or that for zigzag bartacking which is currently selected.</p> <p> : Work clamp foot for linear bartacking</p> <p> : Work clamp foot for zigzag bartacking</p>
R	Information on the multi-layered part of belt loop	<p>The detected multi-layered part of the belt loop will be displayed.</p> <p> : No belt loop</p> <p> : Multi-layered part of belt loop is detected</p>
S	Garment body presser	<p>Displays presence/absence of the additional clamp for the currently-selected garment body presser.</p> <p> : Additional clamp is present.</p> <p> : Additional clamp is absent.</p>

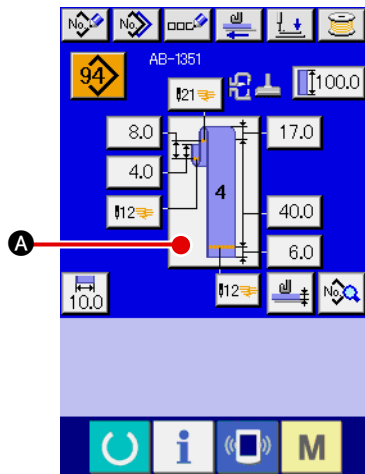
## 2-5. How to change over the sewing shape









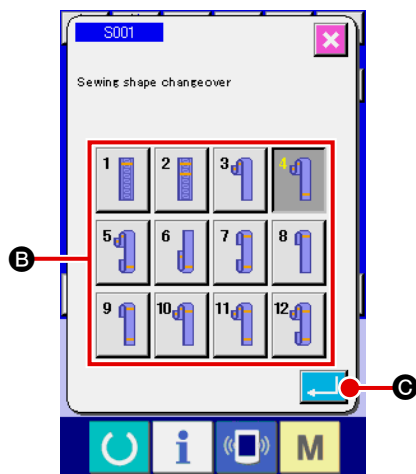





- Display the belt loop individual sewing data entry screen**  
 Only on the belt loop individual sewing data entry screen (blue), changeover of the sewing shape is enabled. On the sewing screen of the belt loop individual sewing (green), press the set ready key  to display the belt loop individual sewing data entry screen (blue).

- Bring up the sewing shape selection screen**

Press sewing shape button  **A**, and the sewing shape selection screen is displayed.



- Select the type of sewing shape and confirm your entry**  
 The following twelve different sewing shapes are available. Select a desired one from among them. Select a desired type of sewing shape by pressing one of sewing shape selection buttons **B** which corresponds to the desired type. Then, press enter button  **C**, and the sewing shape you have selected is confirmed and the screen returns to the belt loop individual sewing data entry screen.

Pictograph	Name	Pictograph	Name
	Belt loop shape No. 1		Belt loop shape No. 7 (Both-end roll type)
	Belt loop shape No. 2		Belt loop shape No. 8
	Belt loop shape No. 3		Belt loop shape No. 9
	Belt loop shape No. 4		Belt loop shape No. 10
	Belt loop shape No. 5		Belt loop shape No. 11
	Belt loop shape No. 6 (Semi-classic type)		Belt loop shape No. 12

## 2-6. How to change the belt loop length

### (1) How to change the belt loop dimensions

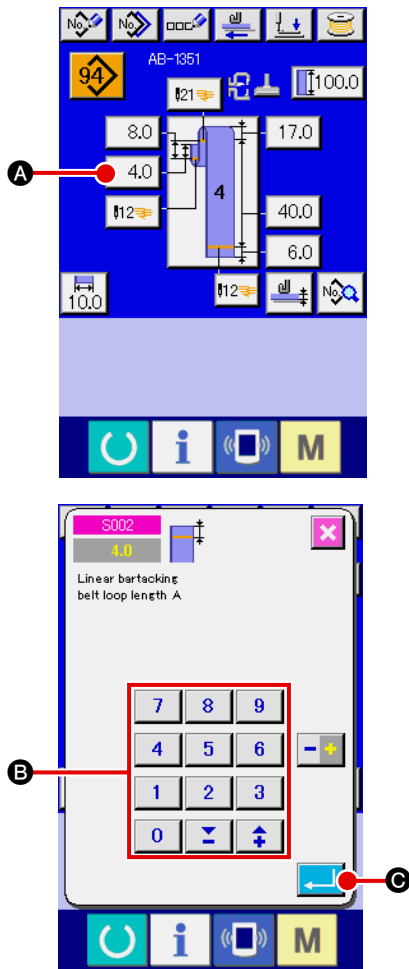

#### ① Displaying the belt loop individual sewing data entry screen

The belt loop dimensions can be changed on the belt loop individual sewing data entry screen. On the sewing screen of the belt loop individual sewing (green), press the set ready key  to display the belt loop individual sewing data entry screen (blue).

#### ② Bringing up the belt loop length entry screen

When you press the button for the belt loop length you want to change, the corresponding belt loop length entry screen is displayed. As an example of belt loop length changing procedure, take belt loop length A in the belt loop shape No. 4. Press button  **A** to display the belt loop length entry screen.

- \* Availability of belt loop lengths A to F depends on belt loop shape (i.e., belt loop shapes No. 1 to No. 12). Therefore, they can be classified into two groups; one group consists of the available belt loop lengths and the other consists of the unavailable ones.
- \* The initial value and settable range of the belt loop length differ with the belt loop shape (i.e., belt loop shapes No. 1 to No. 12).

#### ③ Entering data

Enter a desired value with numeric keys and +/- button **B**.

#### ④ Confirming your entry

Press enter button  **C**, and the data you have entered is confirmed.

- \* For the other belt loop lengths, you can change the data following the steps of procedure described above.

1. The dimensions of the belt loop sewing shape displayed on the operation panel are only for reference. The dimensions vary according to the belt-loop material. Be sure to adjust the settings of belt loop dimensions so that your desired finished dimensions are achieved.



2. Dimension A set by S002 and S003 is common to all sewing shapes. The set value, therefore, remains the same even if you change the sewing pattern. (For sewing shapes Nos. 7, 8 and 9, dimension A set by S028 and S029 is used. This means that the entire length of the belt loop may be out of the range (E483) in the event you have changed the sewing shape.)

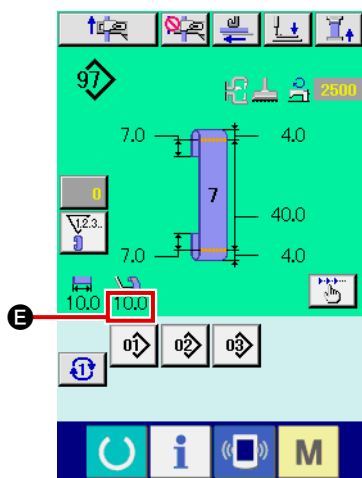
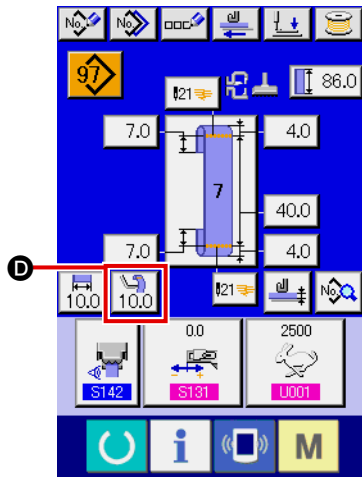

### ⑤ Setting the loosening amount

In the case belt-loop shape No. 7, No. 9, No. 11 or No. 12 is selected, the loosening amount setting button  **D** appears on the belt-loop individual sewing data entry screen.

When you press loosening amount setting button  **D**, the loosening amount setting screen is displayed to enable setting of the loosening amount.

In the case belt loop shape No. 7, No. 9, No. 11 or No. 12 is selected, the loosening amount is displayed in section **E** on the belt-loop individual sewing screen.

## (2) Changing the belt loop length (entire length) and precautions to be taken

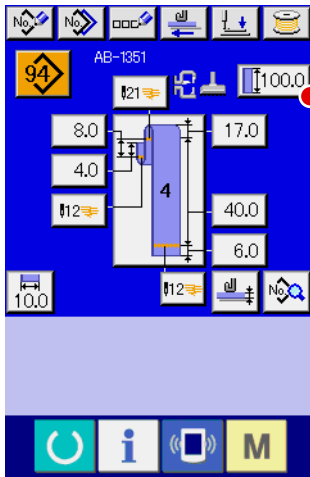

When you press button **F**, the belt loop length (entire length) entry screen is displayed to allow you to change belt loop length (entire length).

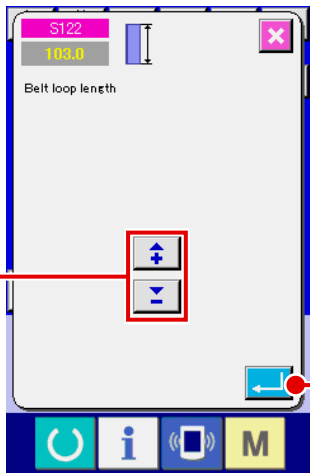

Enter the desired value with +/- button **G**. Then confirm your entry with enter button **H**.

**Caution** In the case you have changed the belt loop length (entire length), the belt loop for each belt loop shape changes in length of the finished dimensions. So, be careful.

Belt loop shape	Finished length of belt loop to be changed
No.1	Belt loop length B
No.2	Belt loop length C
No.3	Belt loop length B
No.4	Belt loop length E
No.5	Belt loop length F
No.6 (semi-classic type)	Belt loop length B
No.7 (both-end roll type)	Belt loop length F
No.8	Belt loop length B
No.9	Belt loop length E
No.10	Belt loop length B
No.11	Belt loop length E
No.12	Belt loop length F

## (3) Changing the belt loop length by the selection of the frame of the work clamp foot

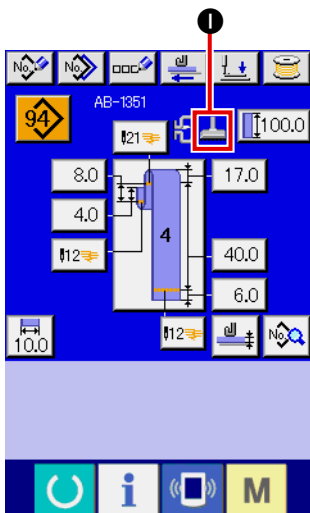

The belt loop dimensions/entire length is changed by changing the frame of the work clamp foot (linear bartacking/zigzag bartacking). When the frame of the work clamp foot is desired to be changed, selection can be made at **N801** of the machine setting. The feeding frame which is currently selected is displayed in **I**.

→ Refer to "[II-2-29. How to set the device](#)", p.98.

## 2-7. How to lower the garment body presser and the work clamp foot

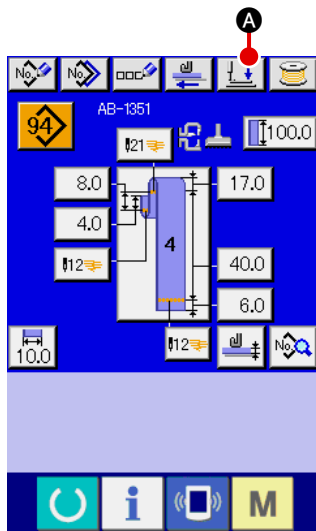



When you press presser lowering button  **A** on the belt loop individual sewing data entry screen (blue) on the sewing screen of the belt loop individual sewing (green), the presser lowering screen is displayed.

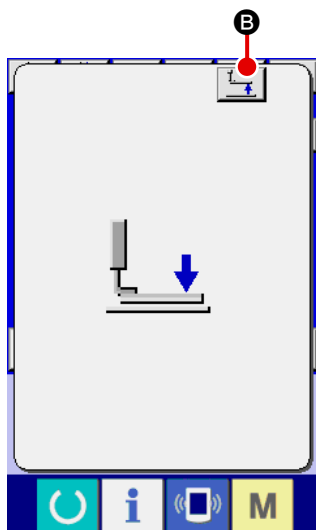

**Even if you press the presser lowering button immediately after turning the power ON, the error buzzer will sound and the presser lowering will not start.**

**Press set ready key  to retrieve the origin to bring up the sewing screen before pressing the presser lowering button.**



When you press presser lowering button  **A**, the sewing machine carries out the following operation and displays the presser lowering screen.

The garment-body presser comes down and moves backward.



The work clamp foot of the machine head comes down.

When you press presser lifting button  **B** on the presser lowering screen, the sewing machine carries out the following operation and goes back to the entry screen (or sewing screen).

The garment-body presser moves forward and goes up.

The work clamp foot of the machine head goes up.



**When you press presser lowering button  **A** or lifting button  **B**, the work clamp foot of the machine head and the garment-body presser operate respectively. Take care not to allow your hands to be caught by the garment-body presser and the work clamp foot.**

## 2-8. Using counter

### (1) Setting procedure of the counter

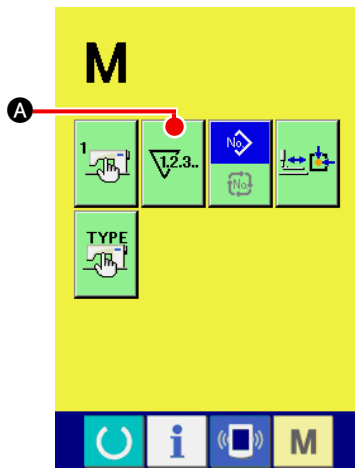

#### ① Display the counter setting screen

Press **M** switch and the COUNTER SETTING button .

**A** is displayed on the screen. When this button is pressed, the counter setting screen is displayed.

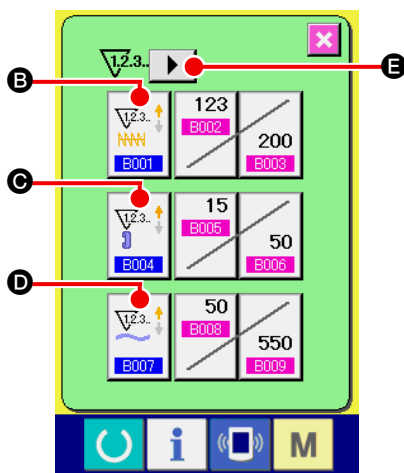

#### ② Selection of kinds of counters

This sewing machine has four different counters; i.e., the bartacking counter, belt-loop counter, No. of pcs. counter and bobbin thread counter.

When BARTACKING COUNTER TYPE SELECT button 

**B**, BELT LOOP COUNTER TYPE SELECT button  **C**

or NO. OF PCS. COUNTER TYPE SELECT button  **D**

is pressed, the corresponding counter type select screen is displayed. On this screen the counter type can be selected individually.

To set the bobbin thread counter, press page changeover button  **E** to change over the page shown on the screen.

Then, press the bobbin thread counter type selection button

 **F** to display the counter type selection screen.

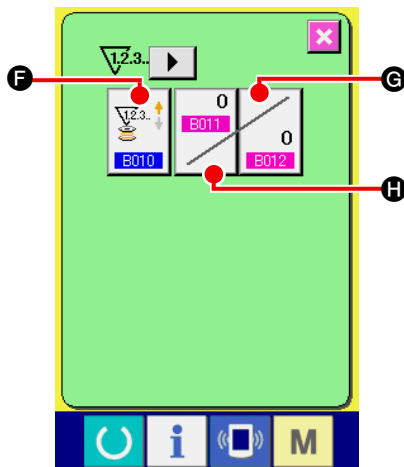



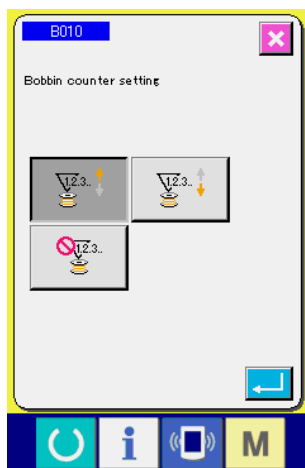
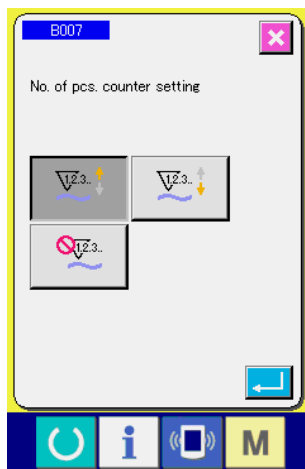
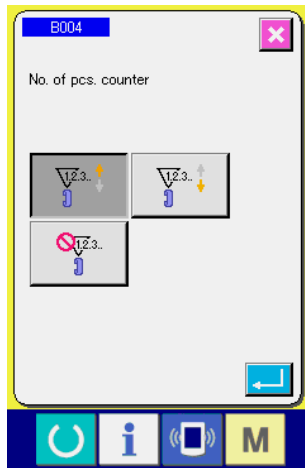
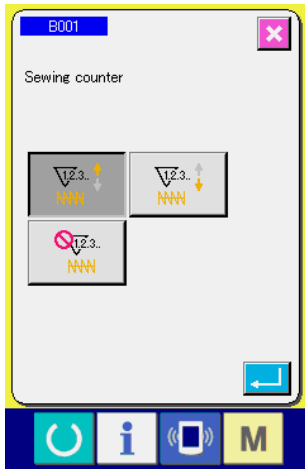

<b>[Bartacking counter]</b>	
	<b>UP counter:</b> Every time the sewing machine sews a bartack, the counter increases its current value by one. When the current value equals to the preset value, the count-complete screen is displayed.
	<b>DOWN counter:</b> Every time the sewing machine sews a bartack, the counter decreases its current value by one. When the existing value is reached "0", the count-up screen is displayed.
	<b>Counter disuse:</b> The bartacking counter does not count a finished shape even when the machine has sewn the shape. The counter screen of the sewing counter is not displayed.



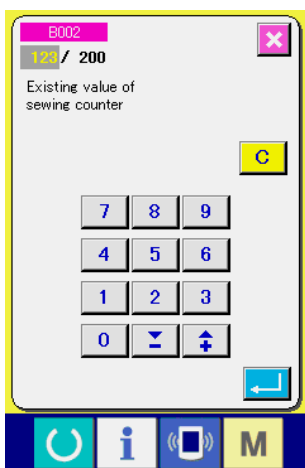
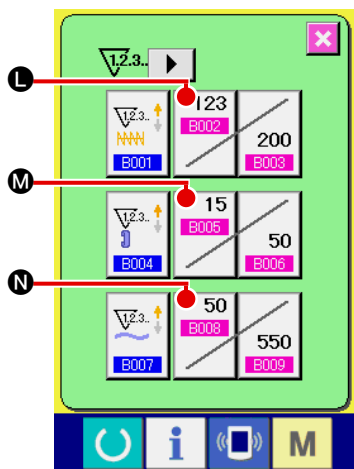
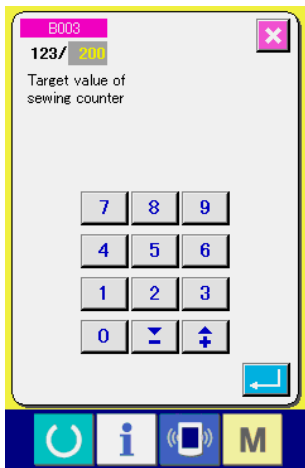
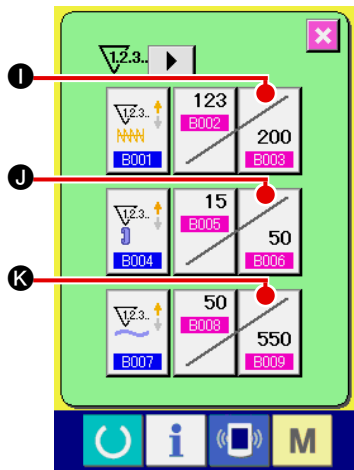

<b>[Belt loop counter]</b>	
	<b>UP counter:</b> Every time the sewing machine sews a belt loop, the counter increases its current value by one. When the current value equals to the preset value, the count-complete screen is displayed.
	<b>DOWN counter:</b> Every time the sewing machine finishes all the belt-loops of a garment under the cycle sewing .mode, the counter decreases its current value by one. When the current value reaches 0 (zero), the count-complete screen is displayed.
	<b>Counter disuse:</b> The belt loop counter does not count a finished shape even when the machine has sewn the shape. The counter screen of the sewing counter is not displayed.

<b>[No. of pcs. counter]</b>	
	<b>UP counter:</b> Every time the sewing machine finishes all the belt loops of a garment under the cycle sewing mode, the counter increases its current value by one. When the current value equals to the preset value, the count-complete screen is displayed.
	<b>DOWN counter:</b> Every time the sewing machine sews a belt loop, the counter decreases its current value by one. When the existing value is reached "0", the count-up screen is displayed.
	<b>Counter disuse:</b> The belt loop counter does not count a finished shape even when the machine has sewn the shape. The counter screen of the No. of pcs. counter is not displayed.

<b>[Bobbin thread counter]</b>	
	<b>UP counter:</b> The value shown on the counter increases by one for every 10 bartacking stitches. When the current value shown on the counter reaches the set value, the count-complete screen is displayed.
	<b>DOWN counter:</b> The value shown on the counter decreases by one for every 10 bartacking stitches. When the current value shown on the counter reaches zero (0), the count-complete screen is displayed.
	<b>Counter disuse:</b> The bobbin thread counter does not work even the machine performs sewing. The count-complete screen for the bobbin thread counter will not be displayed.







### ③ Change of counter set value

Press button  **I** for the bartacking counter, button  **J** for the belt loop counter, button  **K** for the No. of pcs. counter or button  **G** for the bobbin thread counter to display the corresponding counter set value input screen.

Here, input the set value.  
When "0" is inputted in the set value, the display of count-up screen is not performed.

### ④ Changing the current value on the counter

Press button  **L** for the bartacking counter, button  **M** for the belt loop counter, button  **N** for the No. of pcs. counter or button  **H** for the bobbin thread counter to display the corresponding counter current value input screen.

Here, input the existing value.

## (2) Count-up releasing procedure

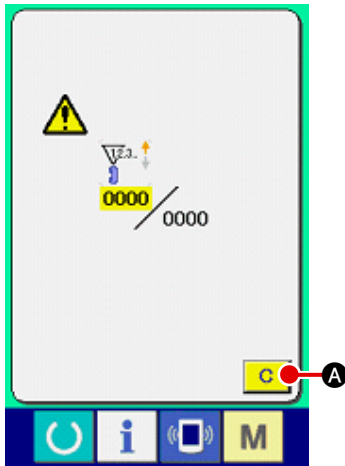

When the count-up condition is reached during sewing work, the count-up screen is displayed and the buzzer beeps. Press CLEAR button **C** **A** to reset the counter and the screen returns to the sewing screen. Then the counter starts counting again.

## (3) How to change the counter value during sewing

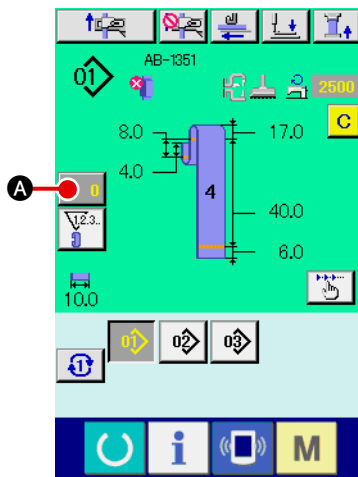

### ① Display the counter value change screen

When you desire to revise the counter value during sewing work due to the mistake or the like, press COUNTER VALUE CHANGE button **C** **A** on the sewing screen. The counter value change screen is displayed.

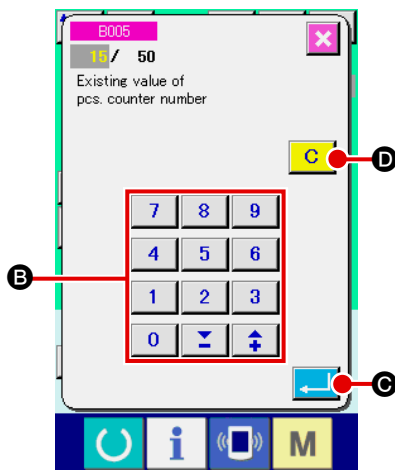

### ② Change the counter value

Input the value you desire with ten keys, or “+” or “-” key **B**.

### ③ Determine the counter value

When ENTER button **C** is pressed, the data is determined.

When you desire to clear the counter value, press CLEAR button **C** **D**.

## 2-9. How to register a new belt loop pattern number

This section describes how to create a new belt loop pattern using the following belt loop pattern as an example.

Pattern number	15
Belt loop shape	No.5
Belt loop width	15 mm
Bartacking shape	28-stitch linear bartacking
Bartacking width	16 mm

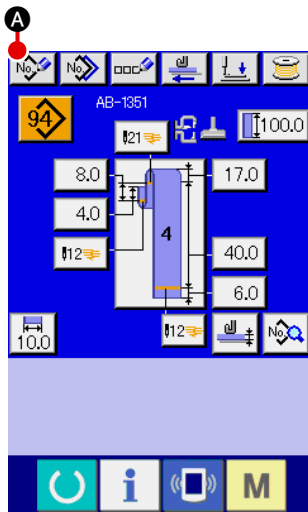



### ① Displaying the data entry screen

When you bring up the entry screen under the belt loop individual sewing mode or the belt loop cycle sewing mode, new pattern creation is enabled. Press new creation button  **A** to display the new belt loop pattern number creation screen.

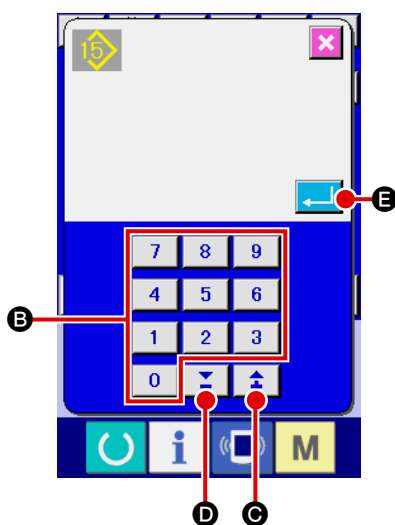
**A** to display the new belt loop pattern number creation screen.



### ② Entering a pattern number

Enter new pattern number 15 with numeric keys **B**. It is also possible to search for an unregistered sewing pattern number using +/- buttons   (**C**, **D**).

When you press enter button  **E**, the new pattern number to create is confirmed and the belt loop shape selection screen is displayed.

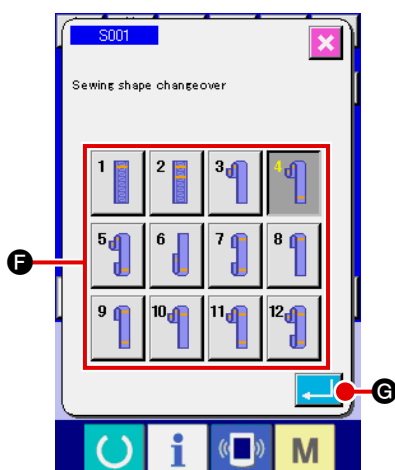

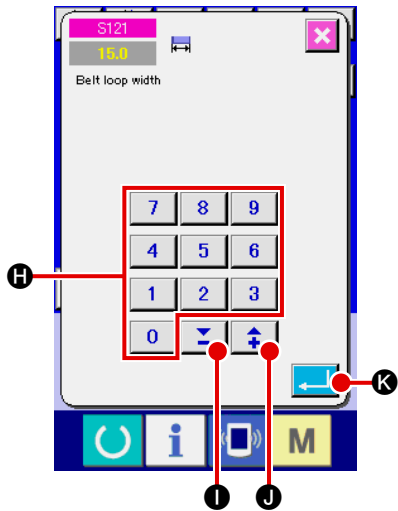

### ③ Selecting a belt loop shape

Select the belt loop shape No. 5 with button **F**. Confirm your entry by pressing enter button  **G**. Then, the belt loop width entry screen is displayed.



④ **Entering a belt loop width**

Enter 15 with numeric keys **H** or +/- buttons   (**I**, **J**) to set the belt loop width to 15 mm. Press enter button  **K** to confirm your entry. Then, the standard pattern selection screen is displayed.

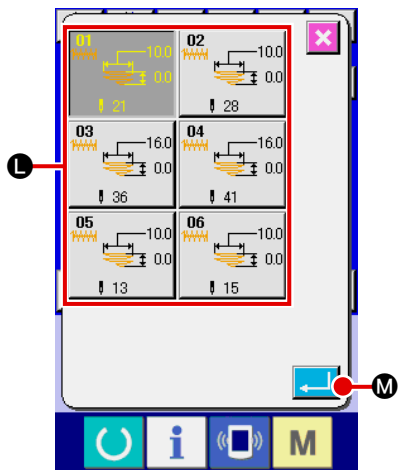



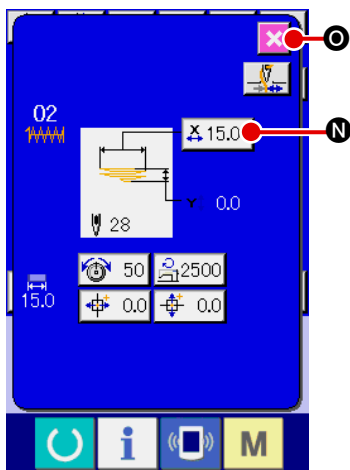

⑤ **Selecting a standard pattern**

Standard sewing pattern, 28-stitch bartacking with button **L**. Press enter button  **M** to confirm your entry. Then, the bartacking information entry screen is displayed.



⑥ **Entering a bartacking width**

When you press X actual dimension value button  **N** on the bartacking information entry screen, and the first bartacking X actual dimension value setting screen is displayed.

Enter 16 with numeric key **P** or +/- buttons   (**Q**, **R**) to set the bartacking width to 16 mm. Press enter button  **S** to confirm your entry. Then screen goes back to the bartacking information entry screen.

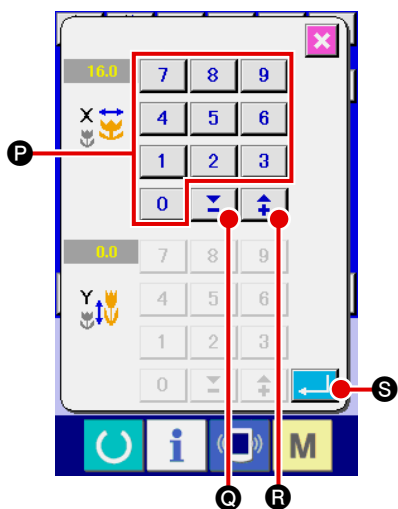

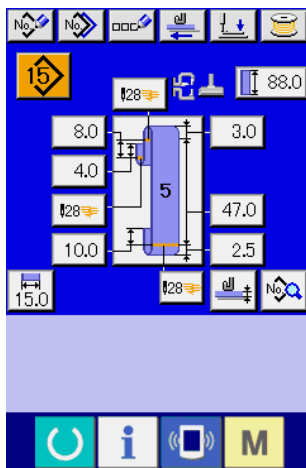

### ⑦ Finishing the creation of a new pattern

When you press close button  **Ⓞ** on the bartacking information entry screen, the screen goes back to the belt loop data entry screen. Check to make sure that the parameters you have set are included on the data entry screen.



If you press the cancel button on any of the screens which appear on the steps of procedure beyond ③, the screen returns to the belt loop data entry screen. In this case, the values of the parameters you have not set shown on the belt loop data entry screen are their initial values.

## 2-10. How to name a belt loop pattern number

It is possible to enter as many as 14 characters for each belt loop pattern number.

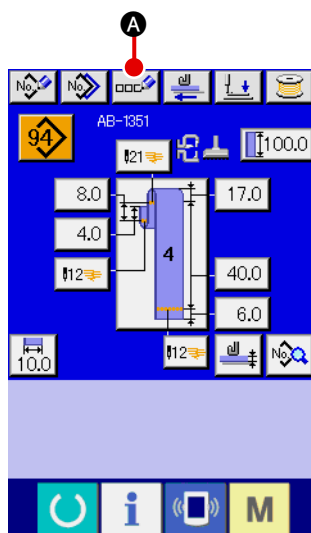

### ① Displaying the data entry screen







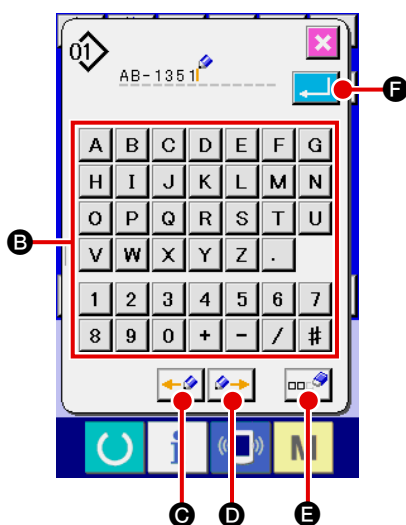

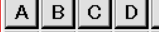

Only on the belt loop individual sewing data entry screen (blue), the name of a belt loop pattern number can be entered. On the sewing screen (green), press the set ready key  to display the data entry screen (blue).

### ② Bringing up the character entry screen

When you press character entry button  **A**, and the character entry screen is displayed.



### ③ Entering characters

Characters can be entered by pressing character button **B** corresponding to the desired character. As many as 14 alphanumeric characters ( ,  ) and symbols ( , , ,  and  ). The cursor can be moved by means of cursor leftward-travel button  **C** or cursor rightward-travel button  **D**. If you want to delete the entered character, move the cursor to the character to delete and press delete button  **E**.

### ④ Finishing the entry of characters

When you press enter button  **F**, the character entry is finished. After the end of the character entry, the characters you have entered are displayed on the upper part of the data entry screen (blue).

## 2-11. How to select a belt loop pattern number

### (1) Selection on the data entry screen

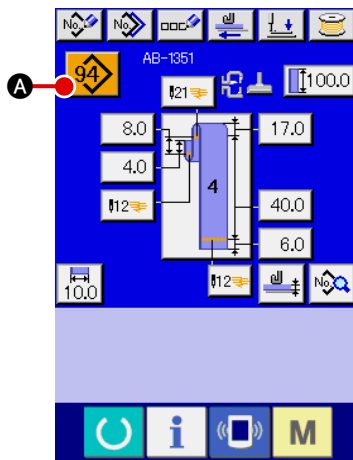

#### ① Displaying the data entry screen

The belt loop pattern number can be selected on the data entry screen (blue). If the sewing screen (green) is displayed, press set ready key  to display the data entry screen.

#### ② Bringing up the pattern number selection screen



When you press belt loop pattern number selection button

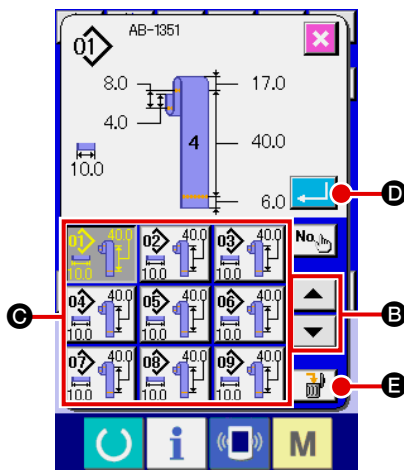

**A**, the belt loop pattern number selection screen is displayed. The belt loop pattern number which is currently selected and its details are displayed on the upper part of the screen and the list of the belt loop pattern number buttons is displayed on the lower part of the screen.



#### ③ Selecting a belt loop pattern number

Every time you press up/down scroll buttons  **B**, the registered belt loop pattern number button  **C** changes over one after another. The button indicates the details of the sewing data entered for the belt loop pattern number. Press belt loop pattern number button **C** corresponding to the pattern you want to select.

#### ④ Confirm the belt loop pattern number

When you press enter button  **D**, the belt loop pattern number selection screen is closed to finish the selection.

- \* If you want to delete the registered belt loop pattern number, press delete button  **E**. It should be noted, however, that the belt loop pattern No. registered in the cycle sewing cannot be deleted.

## (2) Selection by the direct button



### CAUTION :

1. Make sure without fail of the contour of the sewing pattern after selection of the sewing pattern. If the sewing pattern extends outside the work clamp foot, the needle will interfere with the work clamp foot.
2. Be aware that a press on the direct pattern button activates the work clamp foot and the garment-body presser.

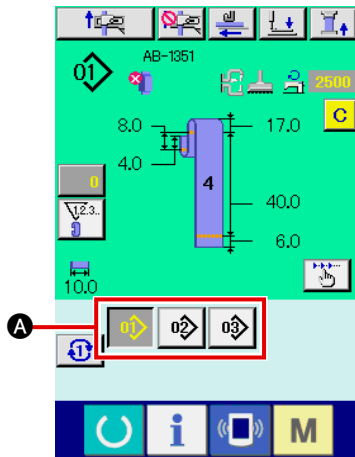

### ① Displaying the data input screen or the sewing screen

When the pattern has already been registered on the direct pattern selection screen, pattern button **A** is displayed on the lower side of the sewing screen without exceptions.

### ② Selecting the pattern No.

When pattern button **A** is pressed, the belt loop pattern No. to be displayed is changed.

Display and press the button of the belt loop pattern No. you desire to sew. When it is pressed, the belt loop pattern No. is selected.



## 2-12. How to copy a belt loop pattern number

It is possible to copy the sewing data of a registered belt loop pattern number to an unregistered belt loop pattern number. Overwrite copy of the belt loop pattern number is prohibited. If you want to overwrite a belt loop pattern number, it is necessary to delete the pattern number you do not need in advance.

→ Refer to "II-2-11. How to select a belt loop pattern number", p.50.

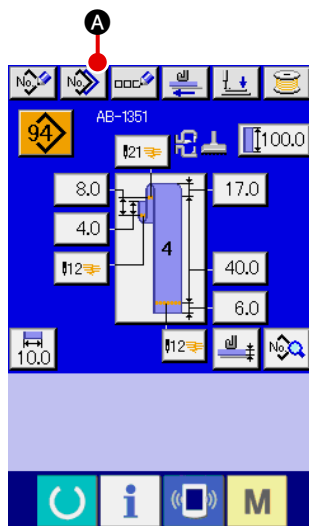

### ① Displaying the data entry screen

Only on the belt loop individual sewing data entry screen (blue) on which the pattern button is selected, the belt loop pattern number can be copied. If the sewing screen (green), is displayed, press the set ready key  to display the data entry screen (blue).

### ② Bringing up the pattern copy screen

When you press pattern copy button  **A**, the pattern button copy (selection of the source pattern to be copied) screen is displayed.

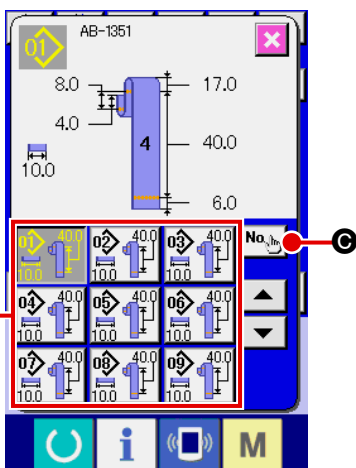



### ③ Selecting a copy source pattern number

Select a copy source belt loop pattern number from belt loop pattern number list button **B**.

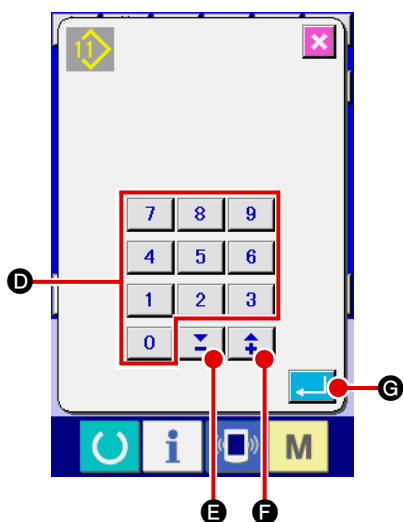
Then, when you press copy destination entry button  **C**, the copy destination entry screen is displayed.



### ④ Entering a copy destination pattern number

Enter a copy destination belt loop pattern number using numeric keys **D**. It is also possible to search for an unused belt loop pattern number using +/- buttons   (**F**, **E**).

### ⑤ Starting copying

Press enter button  **G** to start copy of the belt loop pattern number. The screen will return to the belt loop pattern No. copy (copy source selection) screen with the copied belt loop pattern No. being selected.

\* It is also possible to copy the cycle sewing data following the similar procedure.

## 2-13. Belt loop teaching function

This function works to measure the thickness of multi-layered part of a belt loop and to enable setting of the automatic multi-layered part detection. "Enable/disable" of the automatic multi-layered part detecting function can be selected by means of the memory switch. (Initial state: Enable)



1. For this function, the belt-loop draw-out button should be pressed with a belt-loop placed on the belt-loop draw-out device.
2. If there is little difference between the largest measured thickness and smallest one at the time of data confirmation, the warning screen M601 is displayed since the error (E379) "feed out amount of multi-layered part of material is abnormal" can occur when feeding the actual belt loop.  
To use this function, confirm data after the teaching of both the normal thickness and the multi-layered part thickness of the belt loop.

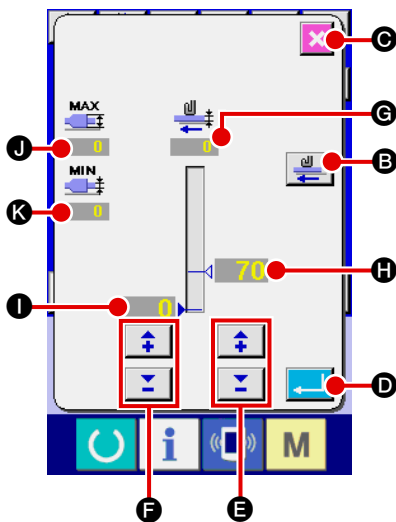
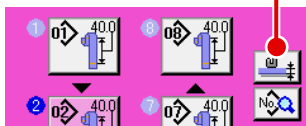
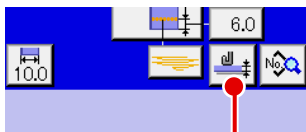

### ① Displaying the teaching screen for belt loop thickness setting

When you press belt loop thickness teaching button (A) on the belt loop individual sewing data entry screen or on the cycle sewing data entry screen, the teaching screen for the belt loop thickness setting is displayed. If the sewing screen (green) is displayed, press the set ready key to display the data entry screen (blue).

### ② Measuring the belt loop thickness

When you press draw-out button (B) after having placed a belt loop on the belt-loop feeder unit, the feeder unit draws out the belt loop to measure the belt loop thickness. The measured value is displayed on (G). As long as you keep the draw-out button held pressed, the value shown on (G) is updated. Largest value (J) and smallest value (K) of the belt loop thickness calculated on the basis of the measured value are displayed.

### ③ Correcting the measured value

Based on the measured value, value (H) which is used for the determination of the presence of a multi-layered part of the belt loop and value (I) which is used for the determination of the absence of a belt loop are automatically calculated. If you want to correct the calculated values, you can change them using +/- buttons (E and F) for the respective values.

### ④ Confirming your entry

Press enter button (D), and the data you have entered is confirmed. If you want to cancel the measured value, press cancel button (C) to close this screen.



Initial value (H) to discriminate the multi-layered part of belt loop and initial value (I) to discriminate no belt-loop state can be set by means of memory switches U504 and U505.

Refer to "II-2-28. How to change memory switch data", p.93 for the method to change the memory switch data.

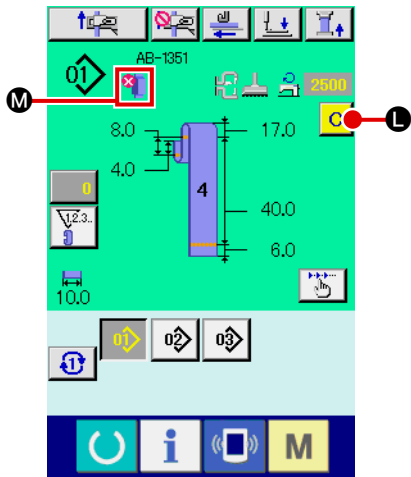

**In the case a multi-layered part of the belt loop is detected**

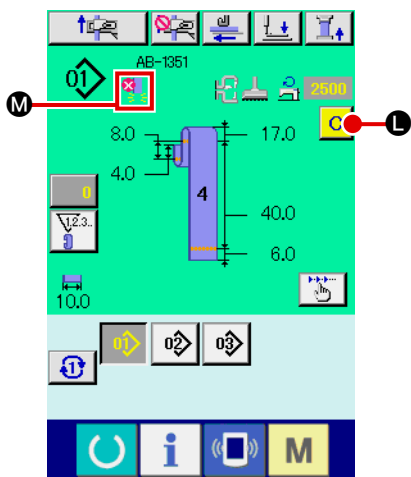

**In the case the absence of a belt loop is detected**

⑤ **Display on the panel concerning the belt-loop multi-layered part detection/no belt-loop detection**



When a belt loop is drawn out with this function enabled after confirmation of the data, the belt-loop status will be displayed in section **M** on the panel if the function determines the presence of a multi-layered part on the belt loop or the absence of a belt loop.

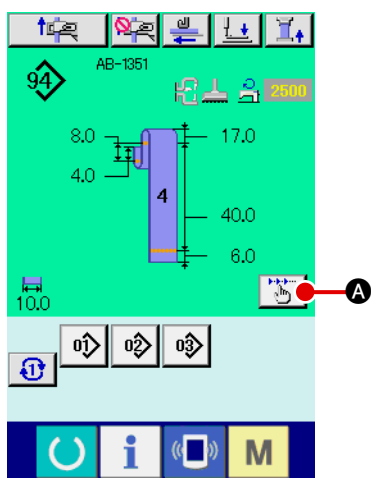

To reset the display and return to the normal display (i.e. nothing is displayed), remove the multi-layered part if there was a multi-layered part, or replenish the belt loop if there was no belt loop, and press the clear button **L** on the input screen.

## 2-14. How to carry out the step operation

The step operation is the function which enables step-by-step operation of the sewing machine. For the AB-1351, two different operations, i.e., setback and sewing position can be checked by means of the step operation.



When you press step operation button  **A** on the sewing screen of the belt loop individual sewing or of the cycle sewing, the step operation selection screen is displayed. If the screen displays the data entry screen (blue), press the set ready key  to display the sewing screen (green).

When you press setback step button  **B**, the screen changes to the setback step operation screen. When you press sewing position step operation button  **C**, screen changes to the sewing position step operation screen.

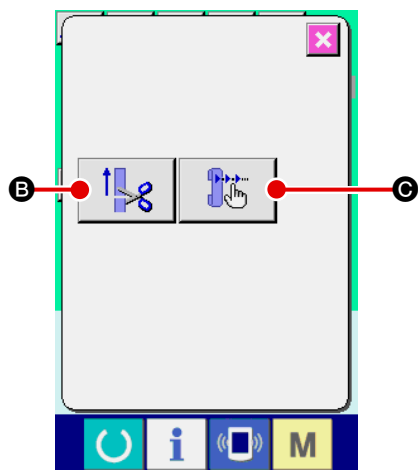

## (1) Setback step operation

The setback operation can be operated on a step-by-step basis.

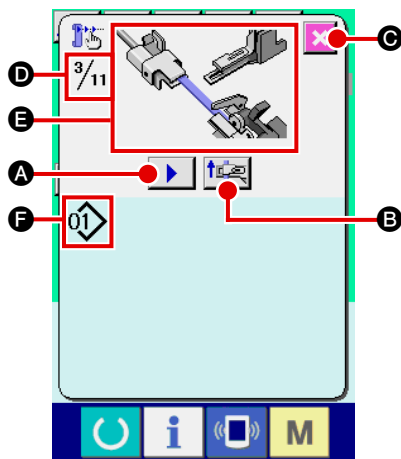

### ① Carrying out the step operation

When you press step feed button  **A**, the belt loop feeder unit carries out one step operation. Picture **E** is displayed to show the aforementioned operation process as it looks. In addition, the step number under edition, the number of entire steps **D** and belt loop pattern number **F** under edition are displayed.

### ② Finishing the step operation

Press cancel button  **C** to close the screen.

### ③ Carrying out the sequential setback operation

If you want to carry out setback operation not on a step-by-step basis but on the basis of sequential operation, press setback operation button  **B** to allow you to check the sequence of setback operation.

## (2) Sewing position step operation

The belt-loop sewing operation can be carried out on a step-by-step basis.

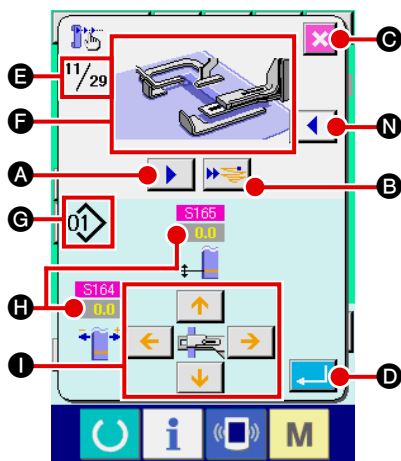

### ① Carrying out the step operation

When you press step feed button  **A**, the belt loop feeder unit carries out one step operation. Picture **E** is displayed to show the aforementioned operation process as it looks. In addition, the step number under edition, the number of entire step **E** and belt loop pattern number **G** under edition are displayed.





In the case of the operation step where the belt loop clamp operates, the confirmation screen is displayed. Be aware that the belt loop clamp goes forward if you press the button on the confirmation screen.

### ② Changing the sewing data

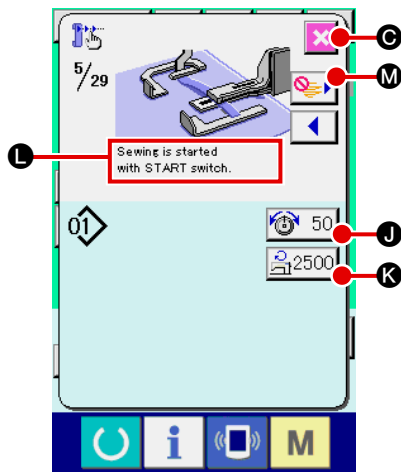
When you check the step operation, changeable sewing data **H** is displayed. Values of the XY directions can be changed by means of parameter change button **I**.



### ③ Starting sewing

When you proceed to the sewing step, message **L** telling that the sewing can be started with the start switch is displayed. At that time, thread tension button  50 **J** and setting button of max. number of revolutions  2500 **K** are displayed. If you want to set those values, you may change the respective values.



Press the start switch to start actual sewing.

### ④ Finishing the step operation

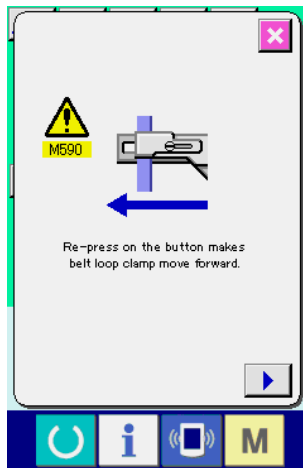
When you press cancel button  **C**, the belt-loop feeder unit will move to the standby position to complete the step operation.



### ⑤ Confirming your entry

To confirm your entry, press enter button  **D**. If you proceed with the step operation without pressing enter button  **D** or terminate the step operation by pressing cancel button  **C**, the data you have entered in the current step will be cancelled.

### ⑥ Carrying out the sewing on the basis of sequential sewing of a belt loop

If you want to carry out sewing of a belt loop not on a step-by-step basis but on the basis of sequential sewing of a belt loop, press one-function forward button  **B**.

Then, the sewing machine will carry out a sequential operation until the next sewing-start step. (Every time you press the button, step operation ③ is carried out.)

As with ③, the sewing machine starts sewing by a press on the start switch.

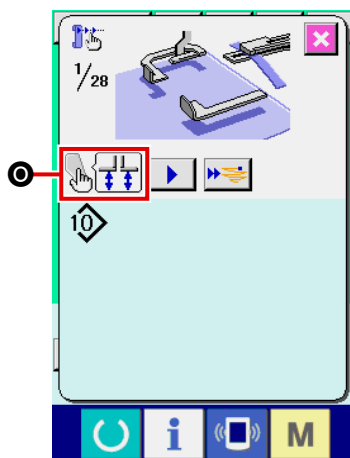

### ⑦ No sewing performed

In the sewing step, if the sewing skip button  **M** is pressed, the machine will move on to the next step without performing the sewing.

### ⑧ Step backward

When the step is desired to be moved backward, press the step backward button  **N**, and the system can be moved backward up to the step allowed by the system.



### ⑨ Lifting/lowering the garment-body presser

The garment-body presser can be lifted/lowered by pressing the start switch at the first step ( **O** is displayed) of the sewing position step operation.

## 2-15. Function of canceling grasping of a belt loop for the next sewing

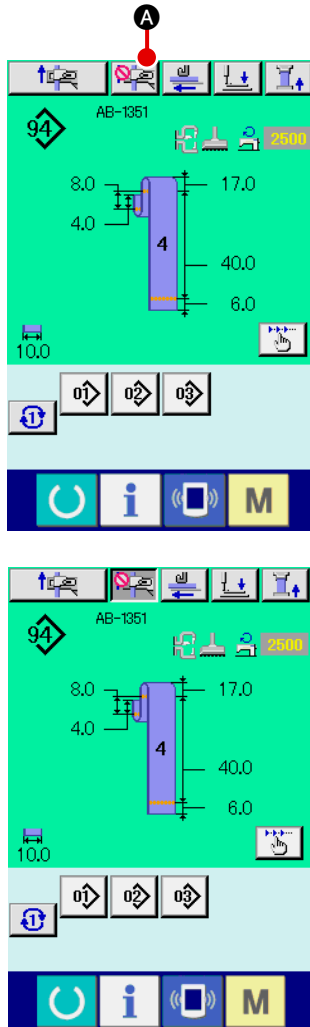
This function is used to prohibit the setback operation after the end of sewing. In the case you know that the power to the machine will be turned off after the end of sewing, or in the case you don't need to setback the next belt so as to change over the product, this function is used to prevent the next belt loop from being grasped uselessly.



When press button  **A**, the button is brought to the depressed state (ON state)  to prohibit the setback operation after the end of sewing. When one sequence of belt-loop sewing is finished in the ON state, the button is reset (OFF state).

In addition to the end of sewing as described above, the cancellation of grasping of a belt loop for the next sewing (prevention of the setback operation after the end of sewing) can be reset from the state where button **A** is pressed in the following cases:



- When the button, which is in the ON state, is pressed again (to place it in the OFF state)
- When the ready key is pressed on the sewing screen (green) to return to the data entry screen (blue);
- When the power is turned OFF;
- When the error screen is displayed;
- When you carry out sewing using the step operation function (the screen changes to the step operation selection screen).

## 2-16. How to carry out the bartacking setting

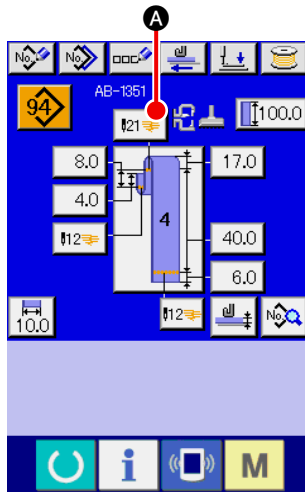

### ① Changing the screen to the LK unit data entry screen

When you press bartacking button  **A** on the belt loop individual sewing data entry screen, the LK unit data entry screen is displayed. You can set the bartacking on this screen.

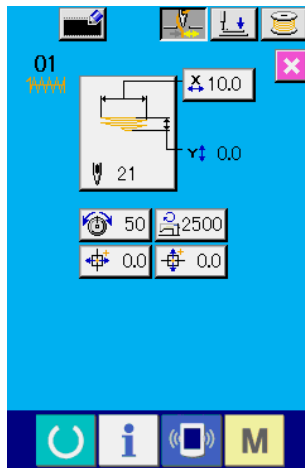



LK unit data entry screen



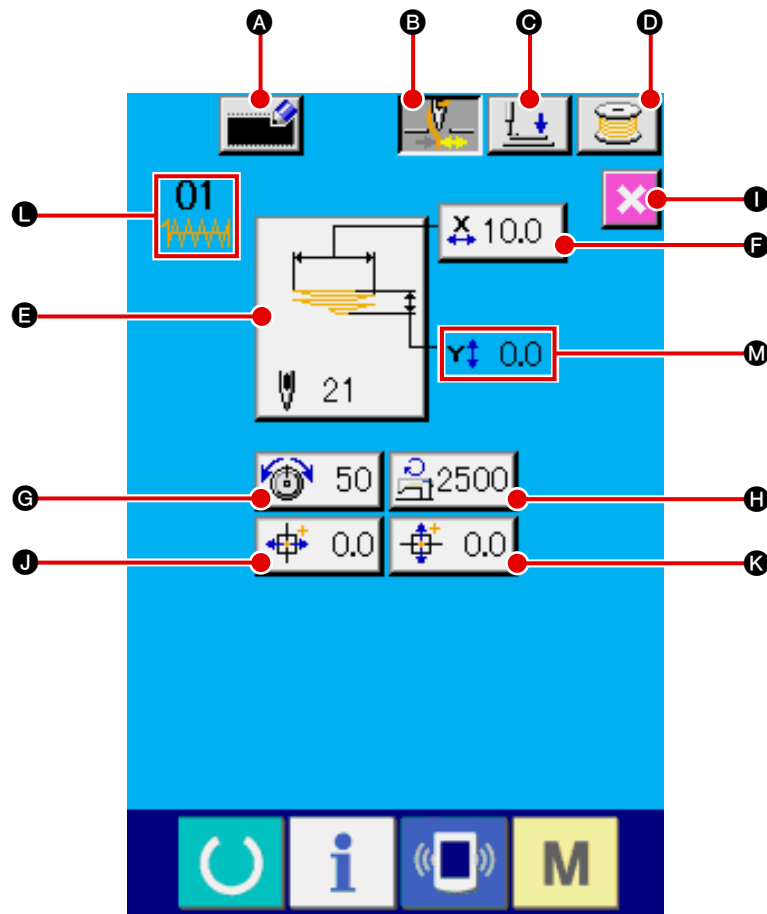

## 2-17. Liquid crystal display at the time of setting the bartacking

### (1) LK unit data entry screen





Symbol	Name of button	Description
<b>A</b>	New user-pattern register button	Displays the new user-pattern register screen. → Refer to " <a href="#">II-2-23. How to register a new user-pattern</a> ", p.71.
<b>B</b>	Thread clamp button	Selects "enable/disable" of the thread clamp.  : Thread clamp is enabled  : Thread clamp is disabled * In the case the thread clamp prohibition is selected with the memory switch U035, the thread clamp button is not displayed.
<b>C</b>	Presser lowering button	Lowest the garment-body presser and the work clamp foot and displays the presser lowering screen. It should be remembered, however, the error alarm buzzer sounds and a press on the button is disabled if the set ready key has not at all pressed up to that time. → Refer to " <a href="#">II-2-7. How to lower the garment body presser and the work clamp foot</a> ", p.42.
<b>D</b>	Threading button	Displays the threading screen. It should be remembered, however, the error alarm buzzer sounds and a press on the button is disabled if the set ready key has not at all pressed up to that time. → Refer to " <a href="#">I-5-2. Winding a bobbin</a> ", p.21.



Symbol	Name of button	Description
Ⓔ	Sewing shape selection button	Displays the sewing shape which is currently selected. When you press the button, the standard pattern number list screen is displayed in the case you have selected a standard pattern or the user-pattern list screen is displayed in the case you have selected a user-pattern. → Refer to " <a href="#">II-2-18. How to select the sewing shape (bartacking setting)</a> ", p.64.
Ⓕ	Actual X-direction value button	Displays the actual dimension value in X direction of the sewing shape which is currently selected. When you press this button, the actual X/Y actual value setting screen is displayed. → Refer to " <a href="#">II-2-20. How to change the item data (bartacking setting)</a> ", p.66.
Ⓖ	Thread tension setting button	Displays, on this button, the needle thread tension value set in the pattern data which is currently selected. When you press the button, thread tension setting screen is displayed. → Refer to " <a href="#">II-2-20. How to change the item data (bartacking setting)</a> ", p.66.
Ⓗ	Max. sewing speed control setting button	Displays the controlled max. sewing speed which is currently set on the button. When you press the button, max. sewing speed control setting screen is displayed. → Refer to " <a href="#">II-2-20. How to change the item data (bartacking setting)</a> ", p.66.
Ⓘ	Close button	Displays the belt loop individual sewing data entry screen and enters the belt loop individual sewing mode.
⓵	X-travel amount setting button	Displays the travel amount of the currently-selected sewing shape in X direction. When pressed, the X-travel amount setting screen is displayed. → Refer to " <a href="#">II-2-20. How to change the item data (bartacking setting)</a> ", p.66.
Ⓚ	Y-travel amount setting button	Displays the travel amount of the currently-selected sewing shape in Y direction. When pressed, the X-travel amount setting screen is displayed. → Refer to " <a href="#">II-2-20. How to change the item data (bartacking setting)</a> ", p.66.

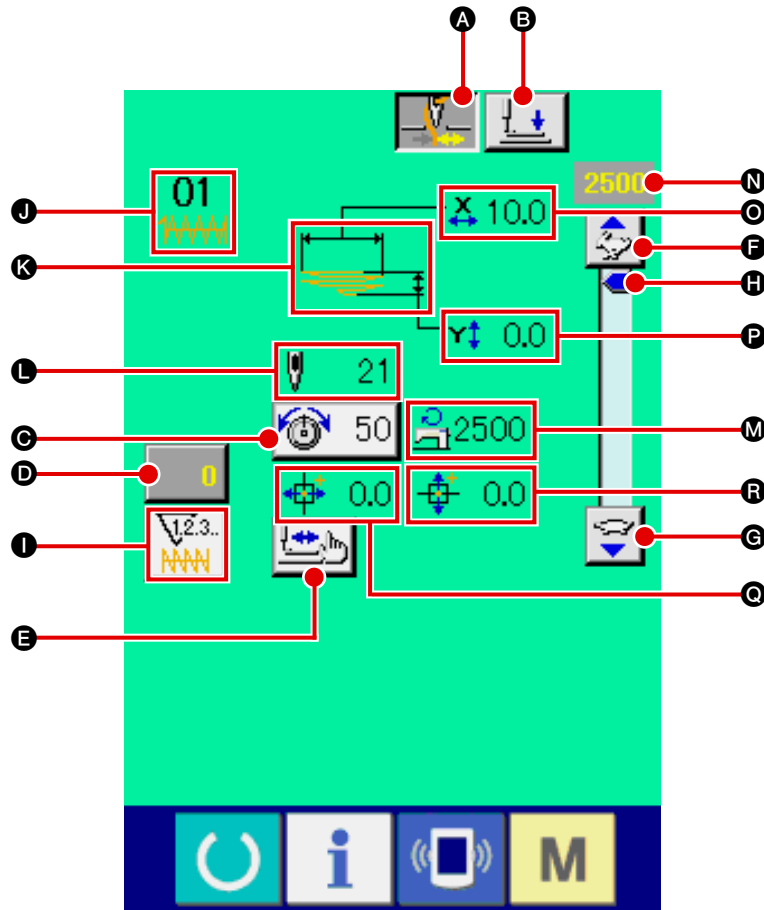

Symbol	Name of image	Description
Ⓛ	Pattern number and type of pattern	Displays the pattern number and the type of pattern (standard pattern/user pattern) which are currently selected.   : Standard pattern   : User pattern
Ⓜ	Actual Y-direction value	Displays the actual dimension value in Y direction of the sewing shape which is currently selected. If the actual dimension value in Y direction is any value other than 0.0, the actual Y-direction value button is displayed.

(2) LK unit sewing screen



Symbol	Name of button	Description
<b>A</b>	Thread clamp button	<p>Selects "enable/disable" of the thread clamp.</p>  : Thread clamp is enabled  : Thread clamp is disabled <p>* In the case the thread clamp prohibition is selected with the memory switch U035, the thread clamp button is not displayed.</p>
<b>B</b>	Presser lowering button	<p>Lowere the work clamp foot and displays the presser lowering screen.                      → Refer to "<b>II-2-7. How to lower the garment body presser and the work clamp foot</b>", p.42.</p>
<b>C</b>	Thread tension setting button	<p>Displays, on this button, the needle thread tension value set in the pattern data which is currently selected. When you press the button, the thread tension setting screen is displayed.                      → Refer to "<b>II-2-20. How to change the item data (bartacking setting)</b>" p.66.</p>
<b>D</b>	Counter value change button	<p>Displays the current counter value on the button. When you press the button, the counter value change screen is displayed.                      → Refer to "<b>II-2-8. Using counter</b>", p.43.</p>
<b>E</b>	Step sewing button	<p>Displays the machine-head jump step sewing screen. You can check the pattern shape on this screen.                      → Refer to "<b>II-2-21. How to check the sewing shape</b>", p.67.</p>
<b>F</b>	Speed-dial setting increase button	<p>Increases the number of revolutions of the sewing machine in increments of 100.</p>

Symbol	Name of button	Description
<b>G</b>	Speed-dial setting decrease button	Decreases the number of revolutions of the sewing machine in increments of 100.
<b>H</b>	Speed-dial setting button	Increases/decreases the number of revolutions of the sewing machine when the button is moved upward or downward.
<b>I</b>	Counter changeover button	<p>Bartacking counter display/bobbin thread counter display can be changed over. The button is displayed only in the case both the bartacking counter and bobbin thread counter are in the ON state.</p> <p> : Bartacking counter</p> <p> : Bobbin thread counter</p> <p>→ Refer to "<b>II-2-8. Using counter</b>", p.43.</p>

Symbol	Name of image	Description
<b>J</b>	Pattern number and type of pattern	<p>Displays the pattern number and the type of pattern (standard pattern/user pattern) which are currently selected.</p> <p> : Standard pattern</p> <p> : User pattern</p>
<b>K</b>	Sewing shape	Displays the sewing shape which is currently selected.
<b>L</b>	Number of stitches	Displays the total number of stitches of the sewing shape which is currently selected.
<b>M</b>	Max. sewing speed control setting	Displays the Max. sewing speed control setting which has been set under the setting mode.
<b>N</b>	Sewing speed	Displays the sewing speed preset with the speed dial.
<b>O</b>	X actual dimension value button	Displays the actual dimension value, in X direction, of the sewing shape which is currently selected.
<b>P</b>	Y actual dimension value button	Displays the actual dimension value, in Y direction, of the sewing shape which is currently selected.
<b>Q</b>	X-travel amount display	Displays the travel amount of the currently-selected sewing shape in X direction.
<b>R</b>	Y-travel amount display	Displays the travel amount of the currently-selected sewing shape in Y direction.

## 2-18. How to select the sewing shape (bartacking setting)

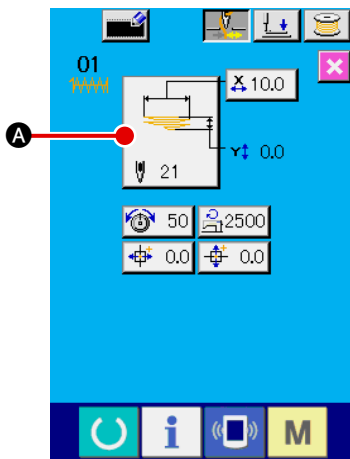

### ① Displaying the data entry screen

Only on the data entry screen (light blue), the sewing shape selection is enabled. On the sewing screen (green), press the set ready key  to the data entry screen (light blue).

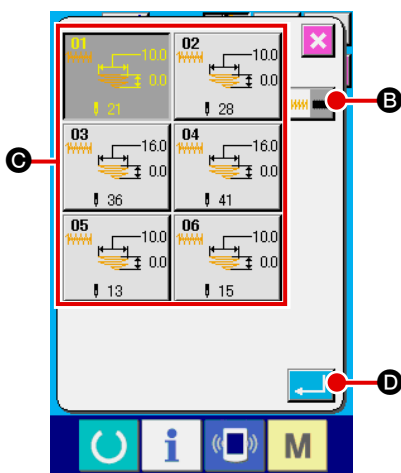

### ② Bringing up the sewing shape selection screen

When you press sewing shape selection button  **A**, the sewing shape selection screen is displayed.



### ③ Selecting the desired type of sewing shape

The following two different types of sewing shapes are available. If you want to change the standard pattern to the user pattern or vice versa, press sewing shape type selection button  **B**.

Pictograph	Name	Max. number of patterns
	Standard pattern	11
	User pattern	200

\* Refer to " [II-2-29. How to set the device](#)", p.98 for the selection of the linear bartacking/zigzag bartacking of the standard pattern.

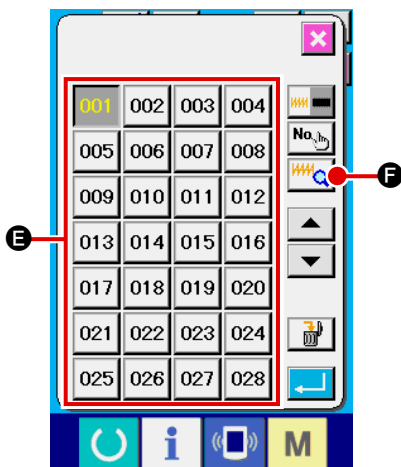

### ④ Selecting the sewing shape

Press sewing shape button **C** which corresponds to the one you want.

### ⑤ Confirming the sewing shape



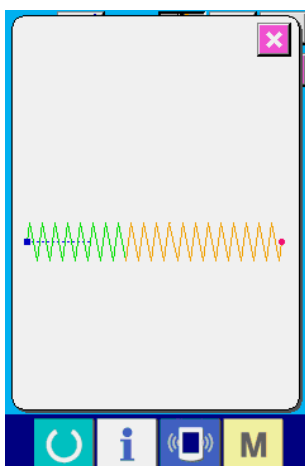

Press enter button  **D** to confirm the sewing shape you have selected. Then, the data entry screen is displayed.

In the case you have selected the user pattern, the screen at left is displayed. Pattern No. selection button **E** appears on the screen. Press the pattern No. button which corresponds to the one you want.

If you want to check the sewing shape you have selected, press viewer button  **F**. Then, the viewer screen is displayed to show the sewing shape you have selected.

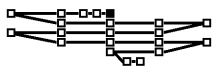
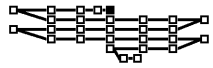
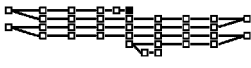

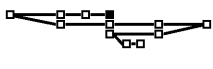
## 2-19. List of sewing shapes

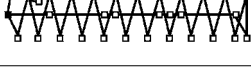
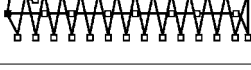
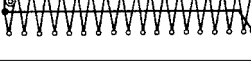
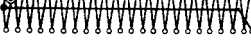
No.	Needle-entry diagram	Number of stitches	Sewing size (mm)	
			Length	Width
1		21	0	12.0
2		28	0	12.0
3		36	0	16.0
4		41	0	16.0
5		12	0	12.0
6		15	0	12.0
7		28	2.5	12.0
8		36	2.5	16.0
9		42	2.5	16.0
10		56	2.5	16.0
11		64	2.5	16.0

\* The sewing size indicated applies when the enlargement factor is 100 %.

## 2-20. How to change the item data (bartacking setting)

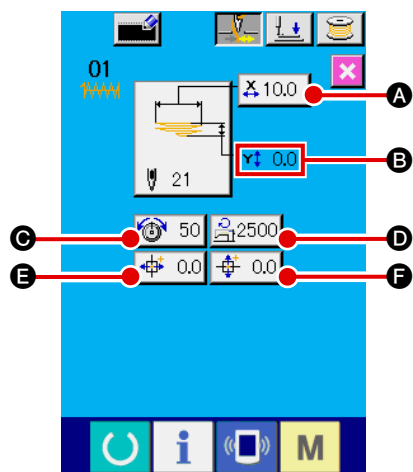

### ① Displaying the data entry screen

On the data entry screen, the item data can be changed. On the sewing screen (green), press the set ready key  to display the data entry screen (light blue).

\* The thread tension value can also be changed on the sewing screen.

### ② Displaying the item data entry screen

When the item data button corresponding to the item you want to change is pressed, the item data entry screen is displayed. There are following six data items.

	Item	Input range	Initial value
A	X actual dimension value	6.0 to 23.0 (mm)	10.0 (mm)
B	Y actual dimension value	0.0 to 3.2 (mm)	0.0 (mm)
C	Thread tension	0 to 200	50
D	Max. sewing speed control	400 to 2500 (sti/min)	2500 (sti/min)
E	X travel amount	-23.0 to 23.0 (mm)	0.0 (mm)
F	Y travel amount	-3.2 to 3.2 (mm)	0.0 (mm)

\* The maximum input range and initial value of max. limiting speed **D** depend on the memory switch U01.

\* Even if the set value of the X/Y travel amount falls within the input range, the actual sewing range may reach the travel limits of the sewing machine. In this case, the out-of-range error E042 will occur.

For example, the X actual dimension value entry procedure is as follows.

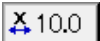
Press  **A** to display the item data entry screen.

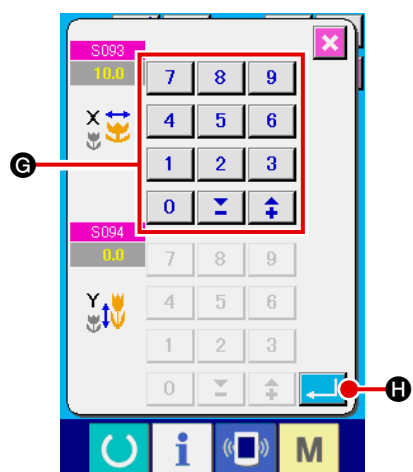

### ③ Entering data

Enter a desired value with the numeric keys and +/- buttons **G**.

### ④ Confirming your entry

When you press enter button  **H**, the data you have entered is confirmed.

\* For the other item data, data can be changed in the similar procedure.

\* X/Y values of the X/Y actual dimension values can be entered on one and the same screen.



- If you turn OFF the power to the sewing machine without having pressed the set ready key, the set values of the pattern number, X/Y actual dimension values, the max. sewing speed, thread tension and X/Y travel amount will not be stored in memory.
- If you change the Y travel amount, the dimensions between bartacks will change.
- Be sure to check the sewing shape by means of the machine head jump step sewing after having changed the X/Y travel amount. If the sewing range exceeds the work clamp foot, the needle can come in contact with the work clamp foot during sewing resulting in needle breakage.

## 2-21. How to check the sewing shape



### CAUTION :

After the pattern selection, be sure to check the shape of the sewing pattern you have selected at all times. If the pattern size is larger than the work clamp foot, the needle can interfere with the work clamp foot during sewing resulting in needle breakage.

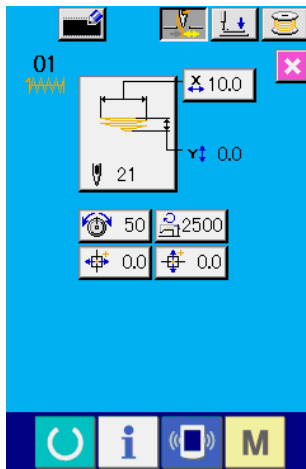

### ① Displaying the sewing screen

Bring up the data entry screen (light blue). When you press the set ready key , the background color of the LCD changes from blue to green. On this screen, sewing is enabled.

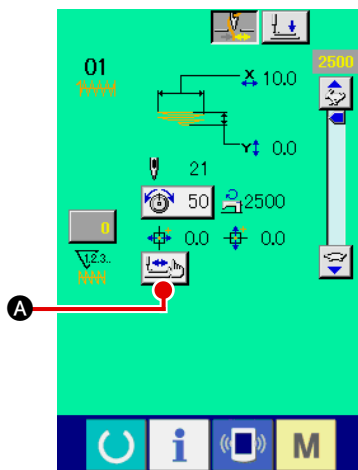

### ② Displaying the machine-head jump step sewing screen

When you press step sewing button  **A**, the machine-head jump step sewing screen is displayed.

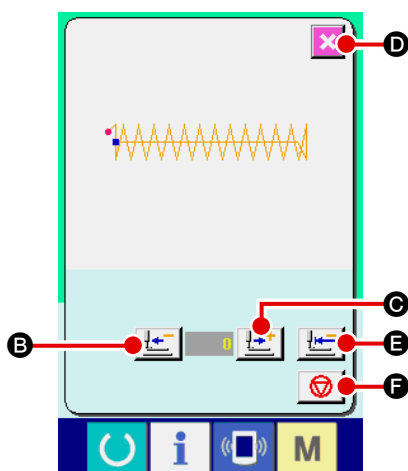



### ③ Lowering the work clamp foot by means of the start switch



In this mode, the sewing machine will not start even if you press the start switch.

### ④ Performing jump sewing with the work clamp foot lowered

Check the sewing shape by means of the work clamp foot backward button  **B** and work clamp foot forward button  **C**.

When you keep either button held pressed, the work clamp foot keeps moving even if you release your finger from the button.

When you want to stop the work clamp foot, press stop button



**F** When you press "move to initial position" button  **E**,

the screen is closed and the LK unit sewing screen is displayed.



If you press the work clamp foot forward/backward button with the needle bar lowered, the work clamp foot will automatically lift the needle bar to its upper position before moving. Be careful.

### ⑤ Finishing checking the sewing shape

When you press cancel button  **D**, the screen returns to the sewing screen.



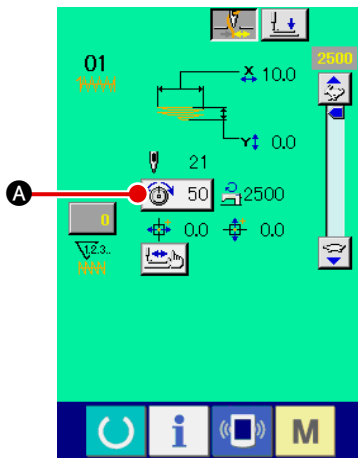

## 2-22. How to change the thread tension command from needle entry point to needle entry point

### (1) How to add/change the thread tension command from needle entry point to needle entry point



#### ① Displaying the thread tension command change screen



Press thread tension button  **A** on the sewing screen when you select a user pattern to display the thread tension setting screen. When you press thread command change button  **B** on the thread tension setting screen, the thread tension command change screen is displayed. If the start switch is pressed, the work clamp foot will be lowered.



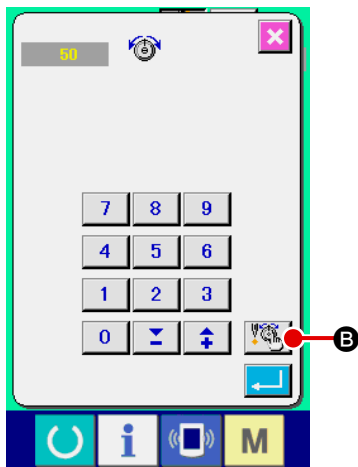



In this mode, the sewing machine will not start even if you press the start switch.



#### ② Specifying the location of the command to be changed

Specify the location to which a new thread tension command you want to add, or at which the current thread tension command value you want to change by means of 1-stitch backward button  **C** or 1-stitch forward button  **D** with the work clamp foot lowered.

You can also move the needle entry point to another one, before or after the current point, at which a thread tension command value is set by means of  **E** or  **F**. To stop moving the needle entry point, press stop button  **G**.

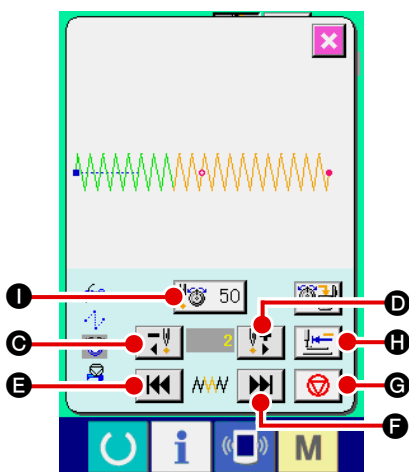

When you press return-to-origin button  **H**, the screen is closed and displays the LK unit sewing screen.

The values shown on the screen are absolute values (thread tension value + Thread tension command value).

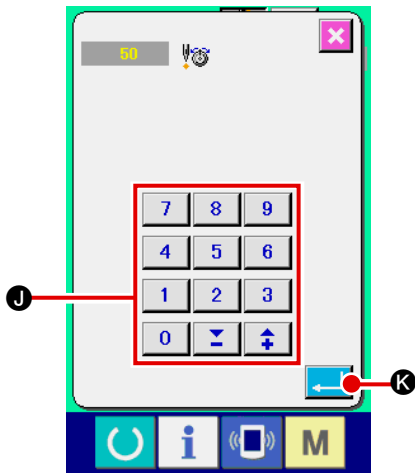





### ③ Entering a thread tension command value

When you press command entry button  **A**, the thread tension increase/decrease value entry screen is displayed. Enter a desired value using the numeric keys and +/- buttons **J**. When you press enter button  **K**, your entry is confirmed.

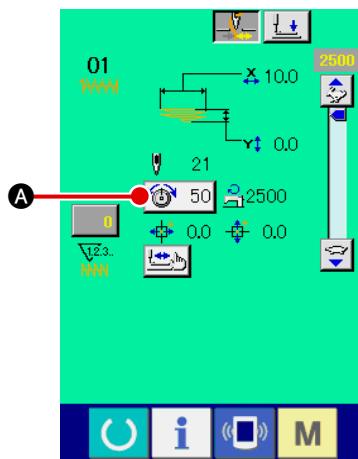
## (2) How to delete the thread tension command from needle entry point to needle entry point





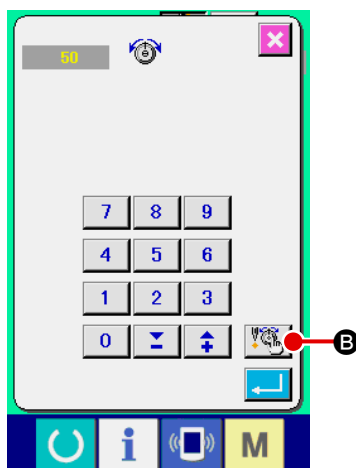

### ① Displaying the thread tension command change screen

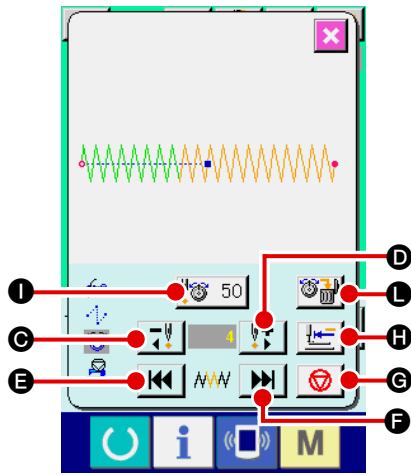

Press thread tension button  **A** on the sewing screen when you select a user pattern to display the thread tension setting screen. When you press thread command change button  **B** on the thread tension setting screen, the thread tension command change screen is displayed.







- ② **Specifying the location of the command to be deleted**  
 Specify the location of the command you want to delete by means of 1-stitch backward button  **C** or 1-stitch forward button  **D** with the work clamp foot lowered.

You can also move the needle entry point to another one, before or after the current point, at which a thread tension command is set by means of  **E** or  **F**. To stop moving the needle entry point, press stop button  **G**.

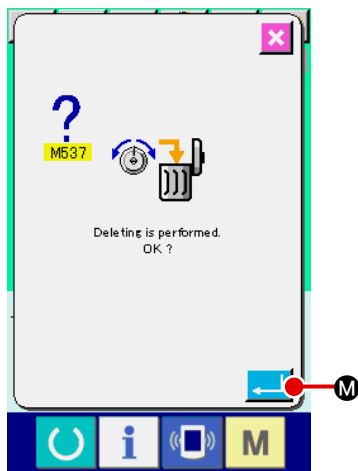
When you press "move to initial position" button  **H**, the screen is closed and the LK unit sewing screen is displayed. In the case the current needle entry point is located on the thread tension command, command delete button  **L** is displayed.



- ③ **Deleting the thread tension command**  
 When you press command delete button  **L**, the command delete screen is displayed. When you press enter button  **M**, the command is deleted.

## 2-23. How to register a new user-pattern

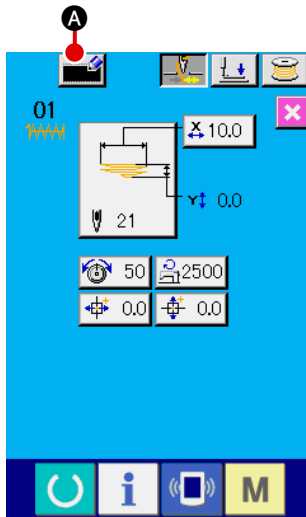

### ① Displaying the data entry screen

Only on the data entry screen (light blue), a new pattern can be registered. On the sewing screen (green), press the set ready key  to display the data entry screen (light blue).

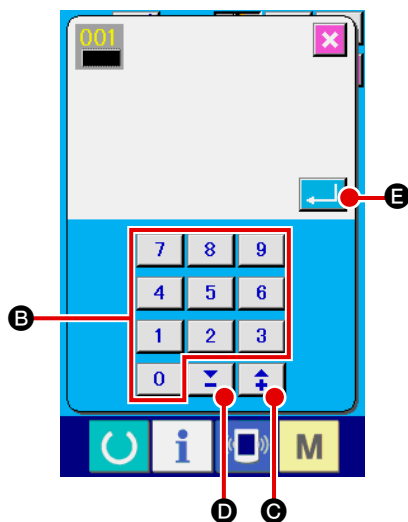

### ② Bringing up the new user-pattern register screen

When you press new register button  **A**, the new user-pattern register screen is displayed.



### ③ Entering a user pattern number

Enter a new user-pattern number you want to register with numeric keys **B**. If you enter the user pattern number which has already been used, E403 will be displayed when you press enter button  **E**. In this case, select another user pattern number which has not been used. It is prohibited to register a new user-pattern to the user pattern number which has already been used.

It is also possible to search user pattern numbers by means of +/- buttons   (**C**, **D**).

### ④ Confirming the user pattern number

When you press enter button  **E**, the new user pattern number to be registered is confirmed. Then, the data entry screen for the user-pattern selection is displayed.

## 2-24. How to change the sewing mode

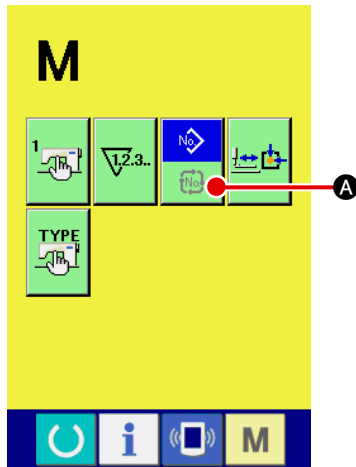

### ① Selecting the sewing mode

When you press the **M** switch in the state where a pattern has already been selected, sewing mode selection button



**A** is displayed on the screen. When you press this button, the sewing mode is changed over between the individual sewing mode and the cycle sewing mode.

- \* The look of the sewing mode selection button varies according to the sewing mode which is currently selected.

When the individual sewing is selected:



When the cycle sewing is selected:



## 2-25. LCD section when the cycle sewing is selected

This model of sewing machine is able to sew belt loops sequentially with several different pieces of belt loop pattern data combined. As many as 30 different belt loop patterns can be entered in a cycle. Use the cycle sewing for sewing belt loops of two or more different sewing shapes for one apparel product. As many as 20 different pieces of cycle sewing data can be registered. Use the cycle sewing by creating a new sewing cycle or copying the existing one according to your need.





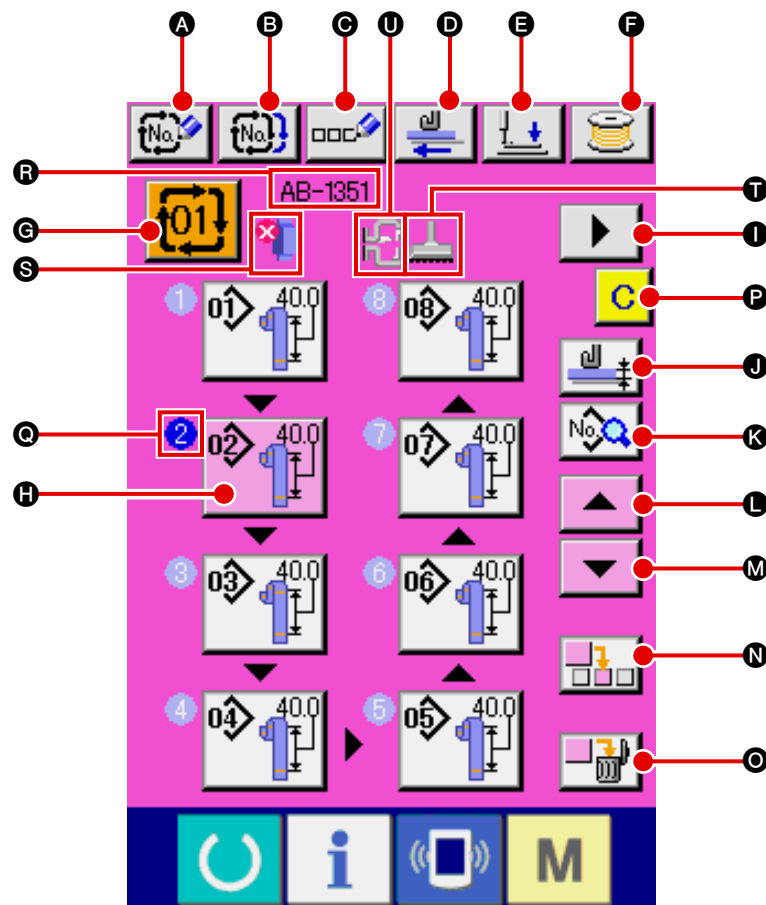

→ Refer to "[II-2-9. How to register a new belt loop pattern number](#)", p.47 and "[II-2-12. How to copy a belt loop pattern number](#)", p.52.

### (1) Cycle sewing data entry screen



Symbol	Name of button	Description
A	Cycle-sewing new data register button	Displays a new cycle-sewing data number register screen. → Refer to " <a href="#">II-2-9. How to register a new belt loop pattern number</a> ", p.47.
B	Cycle-sewing data copy button	Displays the cycle-sewing belt loop pattern number copy screen. → Refer to " <a href="#">II-2-12. How to copy a belt loop pattern number</a> ", p.52.
C	Cycle-data name entry button	Displays the cycle-sewing data name entry screen. → Refer to " <a href="#">II-2-10. How to name a belt loop pattern number</a> ", p.49.
D	Belt loop draw-out button	Insert a belt loop into the belt loop feeder unit and press this button. Then the unit feeds the belt loops.
E	Presser lowering button	Lowers the garment-body presser and the work clamp foot and displays the presser lowering screen. → Refer to " <a href="#">II-2-7. How to lower the garment body presser and the work clamp foot</a> ", p.42.

Symbol	Name of button	Description
F	Bobbin winding button	Enables bobbin winding → Refer to " I -5-2. Winding a bobbin", p.21.
G	Cycle-sewing data No. selection button	Displays, on the button, the cycle-sewing data number which is currently selected. When you press the button, the cycle-sewing data No. selection screen is displayed.
H	Pattern selection button	Ⓜ Displays, on the button, the belt loop pattern numbers registered in the order of sewing sequence and their belt loop shapes. Displays the belt loop pattern data entry screen. * Button pictograph/display of button H or Ⓜ is shown by the number of entered belt loop patterns.
I	Next-page display button	Displayed when the number of belt loop patterns registered in the cycle sewing data becomes 8 or more.
J	Belt loop thickness teaching button	Displays the belt loop thickness setting teaching screen. → Refer to " II-2-13. Belt loop teaching function", p.53.
K	Cycle-sewing sewing data list button	Displays the cycle-sewing sewing data list screen.
L	Scroll up button	Scrolls up the belt loop pattern number to display the previous one.
M	Scroll down button	Scrolls down the belt loop pattern number to display the next one.
N	Step insert button	Inserts a step just before the belt loop pattern number which is currently selected.
O	Step delete button	Deletes the step which is currently selected.
P	Belt loop multi-layered part clear button	Displays the confirmation screen to allow you to determine whether or not the detected multi-layered part of the belt loop (or detected no belt loop state) may be cleared.





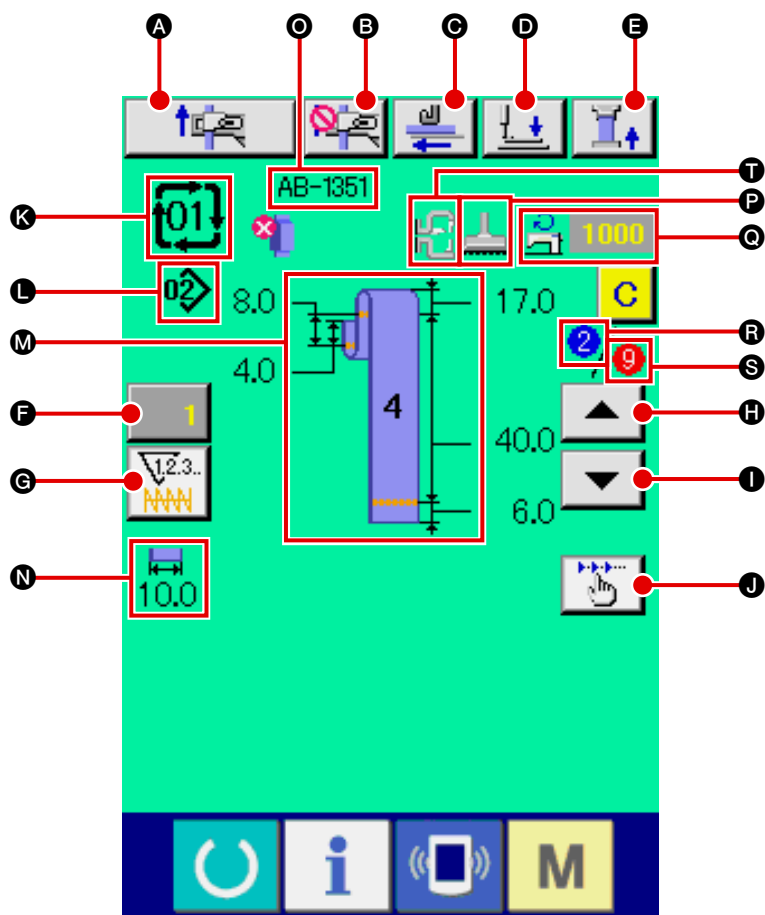

Symbol	Name of image	Description
Q	Order of sewing	Displays the order of sewing of belt-loop pattern data which is being entered. If the screen is changed over to the sewing screen, the belt loop pattern to be sewn first will be displayed in blue. * Button pictograph/display of button H or Ⓜ is shown by the number of entered belt loop patterns.
R	Cycle-sewing data name	Displays the name input into the cycle-sewing data which is currently selected.
S	Information on belt loop multi-layered part	Displays the information on the detected multi-layered part of the belt loop.  : No belt loop  : Multi-layered part of belt loop is detected
T	Frame of the work clamp foot	Displays the work clamp foot for linear bartacking or that for zigzag bartacking which is currently selected.  : Work clamp foot for linear bartacking  : Work clamp foot for zigzag bartacking
U	Garment body presser	Displays presence/absence of the additional clamp for the currently-selected garment body presser.  : Additional clamp is present.  : Additional clamp is absent.





(2) Sewing screen of the cycle sewing



Symbol	Name of button	Description
<b>A</b>	Setback operation button	Carries out the setback operation.
<b>B</b>	Next belt loop grasping cancel button	The machine carries out prohibition (cancel) or reset of belt loop grasping for the next sewing. → Refer to "II-2-15. Function of canceling grasping of a belt loop for the next sewing", p.58.
<b>C</b>	Belt loop draw-out button	When you press draw-out this button after having inserted a belt loop into the belt loop feeder unit, the belt loop feeder unit draws out the belt loop. However, a press on this button is disabled during sewing or setback operation.
<b>D</b>	Presser lowering button	Lowers the garment body presser and the work clamp foot and displays the presser lowering screen. However, a press on this button is disabled during sewing or setback operation. → Refer to "II-2-7. How to lower the garment body presser and the work clamp foot", p.42.
<b>E</b>	Belt loop tension button	Displays the belt loop tension entry screen. At this time, the start switch action will be prohibited.
<b>F</b>	Counter value change button	Displays the current counter value on the button. When you press the button, the counter value change screen is displayed. → Refer to "II-2-8. Using counter", p.43.



Symbol	Name of button	Description
<b>G</b>	Counter changeover button	<p>Bartacking counter display / belt loop counter display / No. of pcs. counter display / bobbin thread counter display can be changed over.</p> <p>The button is displayed only in the case two or more of the aforementioned counters are in the ON state.</p>  : Bartacking counter  : Belt loop counter  : No. of pcs. counter  : Bobbin thread counter <p>→ Refer to "<b>II-2-8. Using counter</b>", p.43.</p>
<b>H</b>	Order-of-sewing backward button	<p>Restores the belt loop pattern to be sewn to the previous one.</p> <div style="border: 1px dashed black; padding: 5px;">  <b>Be aware that a press on this button activates the work clamp foot and the garment-body presser.</b> </div>
<b>I</b>	Order-of-sewing forward button	<p>Restores the belt loop pattern to be sewn to the next one.</p> <div style="border: 1px dashed black; padding: 5px;">  <b>Be aware that a press on this button activates the work clamp foot and the garment-body presser.</b> </div>
<b>J</b>	Step operation button	<p>Displays the step operation selection screen and enables the step operation mode. While the machine is carrying out the set-back operation, however, this button is disabled even if it is pressed.</p> <p>→ Refer to "<b>II-2-14. How to carry out the step operation</b>", p.55.</p>

Symbol	Name of image	Description
<b>K</b>	Cycle-sewing data No.	Displays the cycle-sewing data number which is currently selected.
<b>L</b>	Belt loop pattern No.	Displays the belt loop pattern number which is currently selected.
<b>M</b>	Belt loop pattern description	Displays the description of the belt loop pattern to be sewn.
<b>N</b>	Belt loop width	Displays the belt loop width which is currently set.
<b>O</b>	Cycle-sewing data name	Displays the name input into the cycle-sewing data which is currently selected.
<b>P</b>	Frame of the work clamp foot	<p>Displays the work clamp foot for linear bartacking or that for zigzag bartacking which is currently selected.</p>  : Work clamp foot for linear bartacking  : Work clamp foot for zigzag bartacking
<b>Q</b>	Number of revolutions for sewing	Displays the number of revolutions (set value) for the bartacking pattern which is being sewn.
<b>R</b>	Order of sewing	Displays the order of sewing which is being carried out.
<b>S</b>	Display of the total number of registered patterns	Displays the total number of belt loop patterns registered in the cycle-sewing data number which is being sewn.
<b>T</b>	Garment body presser	<p>Displays presence/absence of the additional clamp for the currently-selected garment body presser.</p>  : Additional clamp is present.  : Additional clamp is absent.

## 2-26. How to carry out cycle sewing

It is necessary first to change sewing mode to the cycle sewing before setting data.

→ Refer to "[II-2-24. How to change the sewing mode](#)", p.72.

### (1) Selection of the cycle-sewing data

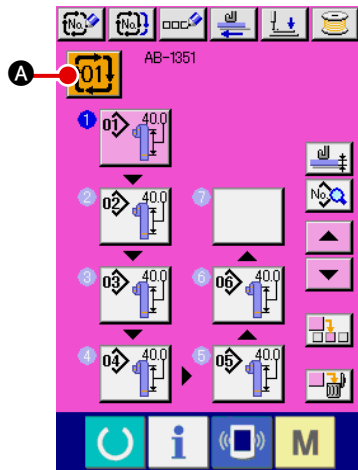

#### ① Displaying the data entry screen

Only on the data entry screen (pink), the cycle-sewing data number can be selected. On the sewing screen (green), press the set ready key  to display the data entry screen (pink).

#### ② Bringing up the cycle-sewing data number selection screen

When you press cycle-sewing data No. button  **A**, the cycle-sewing data number selection screen is displayed. The cycle-sewing data number which is currently selected and its description are displayed on the upper part of the screen. The other registered cycle-sewing data numbers and buttons are displayed on the lower part of the screen.

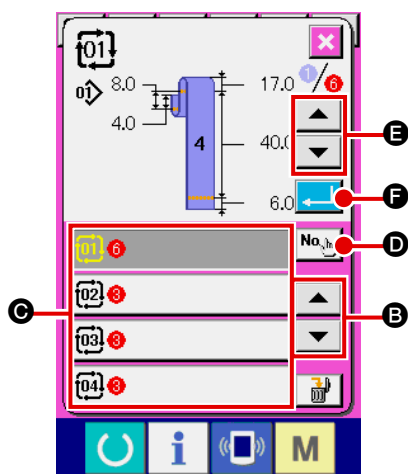

#### ③ Selecting the cycle-sewing data number

Every time you press upper/lower scroll buttons  **B**, the cycle-sewing data No. button **C** changes over one after another.

It is also possible to bring up the cycle-sewing data number entry screen with number input button  **D** and directly enter the cycle-sewing data number.

Now, press cycle-sewing data No. button **C** you want to select.

When you press step confirmation buttons  **E**, sewing shape, etc. registered in the cycle-sewing data are displayed one after another.

#### ④ Confirming the cycle sewing data number

When you press enter button  **F**, the cycle-sewing data number selection screen is closed to finish selection.

## (2) Method to create the cycle-sewing data

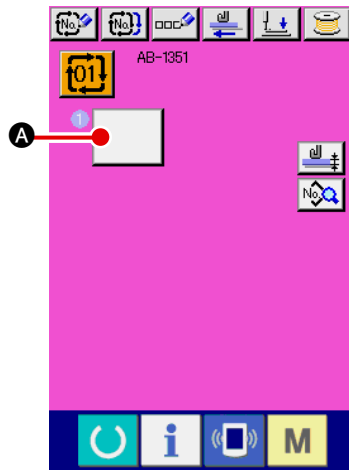

### ① Displaying the data entry screen

Only on the data entry screen (pink), the cycle-sewing data number can be selected. On the sewing screen (green), press the set ready key  to display the data entry screen (pink).

Since no pattern number is registered in the initial screen, the first pattern selection button is displayed in the blank state.

### ② Displaying the pattern number selection screen

When you press pattern selection  **A**, the pattern number selection screen is displayed.

### ③ Selecting a pattern number

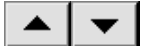
Every time you press up/down scroll buttons  **B**, the registered pattern number button **C** changes over one after another.

It is also possible to bring up the pattern number entry screen with number input button  **D** and directly enter the pattern number.

The button displays the description of the pattern data. Now, press pattern No. button you want to select.



### ④ Confirming the pattern number

When you press enter button  **E**, the pattern number selection screen is closed to finish selection.

### ⑤ Repeating steps of procedure ② through ④ by the number of patterns you want to register

Once the first registration is confirmed, the 2nd pattern selection button  **F** will be displayed.

Repeat steps of procedure ② through ④ by the number of patterns you want to register.

You can select the pattern No. button by pressing up/down scroll buttons  **G**. The selected pattern No. button is displayed in pink .

When you press pattern No. button **H** shown on the display, the belt loop pattern data entry screen is displayed. On this screen, you can set each parameter of the pattern data separately.

If you change the parameter on the belt-loop pattern data entry screen of the cycle sewing screen, the parameter of the original belt-loop pattern will be changed. When setting a parameter, the confirmation screen M589 is displayed. Press enter button  **E** as long as no problem will be caused by changing the parameter.

→ Refer to "[II-2-6. How to change the belt loop length](#)", p.39 for details.

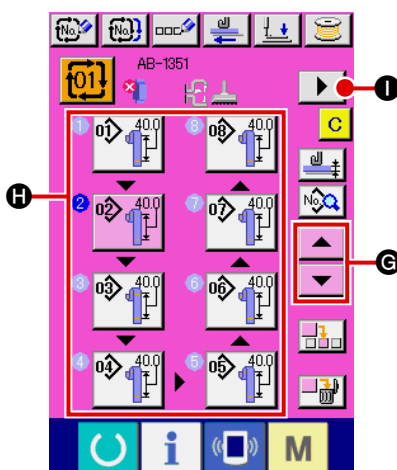
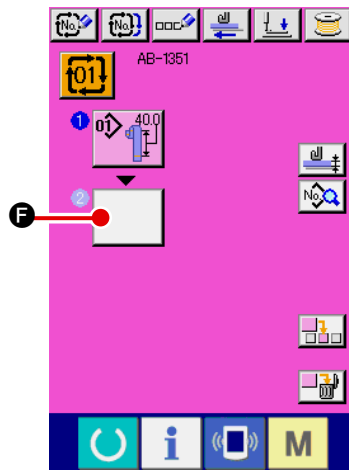
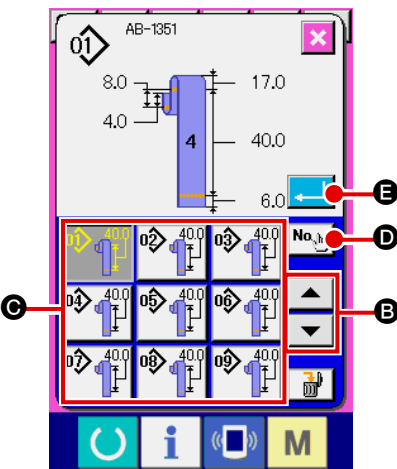

When the combined data you have created requires several screens, you can display the next screen with screen scroll button  **I**.

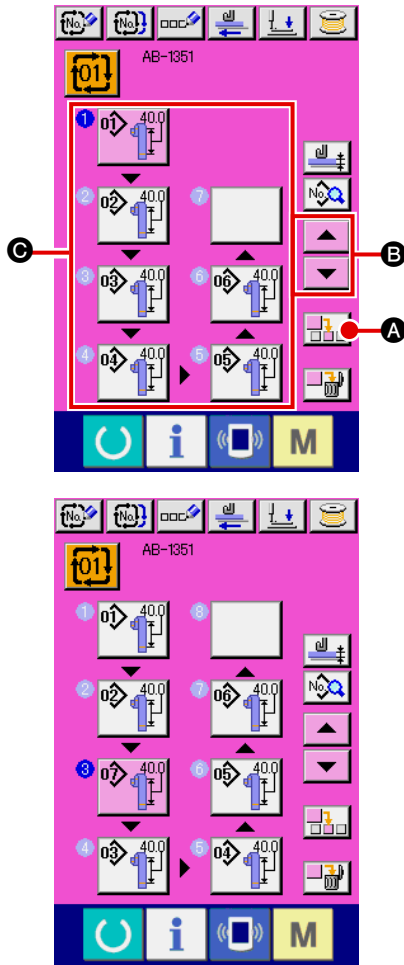

### (3) Method to insert the cycle-sewing data



#### ① Determining the insertion position

When you press pattern No. insert button  **A**, a sewing step is inserted into the location between the previous pattern number and the pattern number which is being selected (displayed in pink). Determine location **C** into which a sewing step is to be inserted by means of up/down scroll buttons  **B** and press pattern No. insert button  **A**.

#### ② Selecting the pattern number to be inserted and confirming it

When you press pattern No. insert button  **A**, the pattern number list screen is displayed.

Carry out steps of procedure ③ through ④ described in "[II-2-26. \(2\) Method to create the cycle-sewing data](#)", p.78.

Once you have confirmed the pattern number, the selected pattern number is displayed at the determined location of insertion.

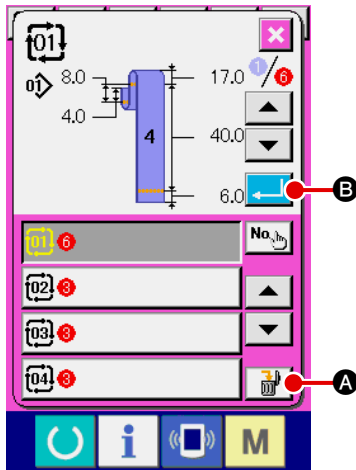

#### (4) Method for deleting the cycle sewing data



##### ① Selecting the cycle sewing data number

Carry out steps of procedure ① to ③ described in "II-2-26. (1) Selection of the cycle sewing data", p.77 to display the cycle sewing data you want to delete.

##### ② Deleting the cycle sewing data

When you press date delete button  **A**, the cycle sewing data delete confirmation popup window will appear on the screen. If you press  **B** on the popup window, the cycle sewing data you have selected is deleted.

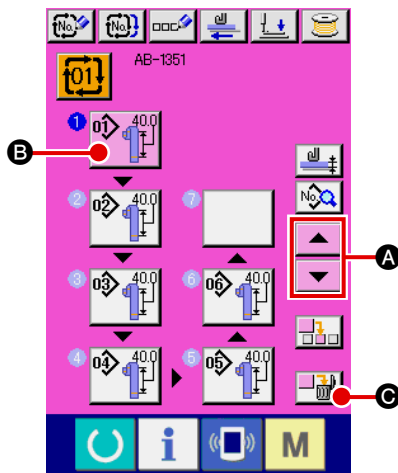

#### (5) Method for deleting a step of the cycle sewing data



##### ① Selecting the cycle sewing data number

Carry out steps of procedure ① to ② described in "II-2-26. (1) Selection of the cycle sewing data", p.77 to place the cycle sewing data which contains the step you want to delete in the selected state.

##### ② Displaying the pattern No. selection screen

Press up/down scroll buttons  **A** to place the pattern selection button of the step you want to delete in selected state  **B**, and press step delete button  **C**. Then, the data step delete popup window is displayed.

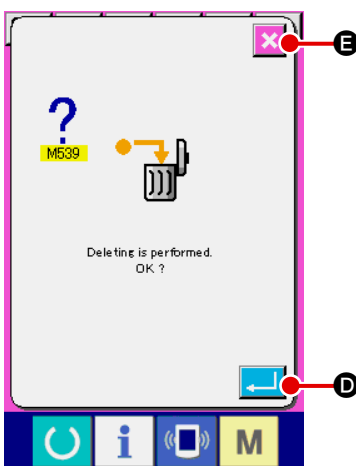

##### ③ Deleting the step of the cycle sewing data you want to delete

When you press enter button  **D**, the selected step of the cycle sewing data is deleted.

If you press cancel button  **E**, the screen returns to the cycle sewing data entry screen without deleting the selected step.

## 2-27. How to edit the sewing data

### (1) Method for changing the sewing data

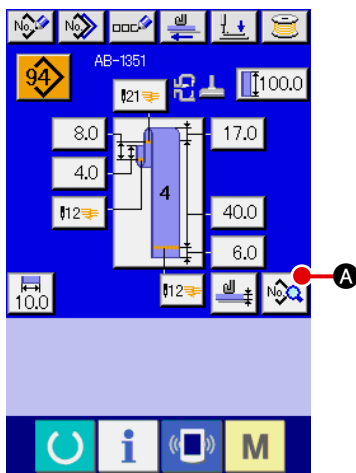

#### ① Displaying the entry screen

When you bring up the data entry screen for the belt loop in individual sewing mode or the belt loop cycle-sewing mode, you can change the sewing data.

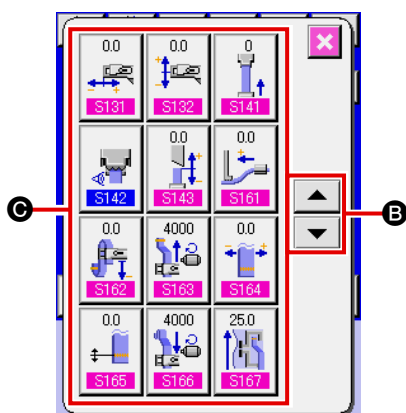

#### ② Selecting the sewing data to be changed

When you press sewing data list button  **A**, the sewing data list screen is displayed. Select the data you want to change.

Select data item button **C** you want to change by pressing up/down scroll buttons  **B**.

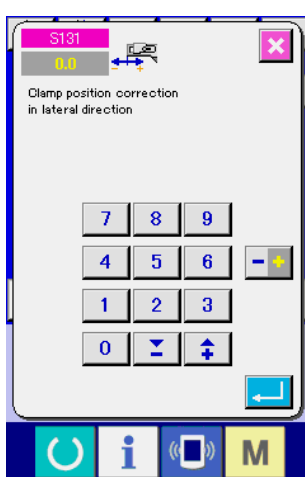

#### ③ Changing the sewing data

Sewing data consists of two different types of data items; one type of data item requires changing of the numeric data, and the other type of data item requires changing of the pictograph.

The data item requiring changing of the numeric data is assigned with a number such as **S131** displayed in pink. The numeric data can be changed by means of the numeric keys and +/- buttons shown on the data change screen.

The data item requiring changing of the pictograph is assigned with a number such as **S142** displayed in blue. The pictograph can be selected from those shown on the change screen.

\* Refer to (2) Sewing data list for the details of sewing data.











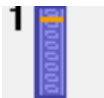















**If you turn OFF the power to the sewing machine without having pressed the set ready key, the set values of the sewing data will not be stored in memory.**





















**The dimensions of the belt loop sewing shape displayed on the operation panel are only for reference. The dimensions vary according to the belt loop material. Be sure to adjust the settings of belt loop dimensions so that your desired finished dimensions are achieved.**

(2) Sewing data list

No.	Item	Input range/ selection range	Initial value
S001	<b>Belt loop sewing shape</b>  : No.1  : No.2  : No.3  : No.4  : No.5  : No.6  : No.7  : No.9  : No.9  : No.10  : No.11  : No.12	No. 1 to No. 12	No.4
S002	<b>Linear bartacking belt loop length A</b> Entry of belt loop length A when the work clamp foot for linear bartacking is used 	-10.0 to 19.0 (mm)	4.0 (mm)
S003	<b>Zigzag bartacking belt loop length A</b> Entry of belt loop length A when the work clamp foot for zigzag bartacking is used 	-9.0 to 21.0 (mm)	6.0 (mm)
S004	<b>Belt loop length B for sewing shape No. 1</b> 	59.0 to 99.0 (mm)	79.0 (mm)
S005	<b>Belt loop length B for sewing shape No. 2</b> 	15.0 to 30.0 (mm)	17.0 (mm)
S006	<b>Belt loop length C for sewing shape No. 2</b> 	45.0 to 99.0 (mm)	62.0 (mm)
S007	<b>Belt loop length B for sewing shape No. 3</b> 	45.0 to 109.0 (mm)	71.0 (mm)
S008	<b>Linear bartacking belt loop length C for sewing shape No. 3</b> 	5.0 to 11.0 (mm)	8.0 (mm)
S009	<b>Zigzag bartacking belt loop length C for sewing shape No. 3</b> 	5.0 to 11.0 (mm)	8.0 (mm)
S011	<b>Belt loop length B for sewing shape No. 4</b> 	30.0 to 50.0 (mm)	40.0 (mm)
S012	<b>Linear bartacking belt loop length C for sewing shape No. 4</b> 	5.0 to 11.0 (mm)	8.0 (mm)
S013	<b>Zigzag bartacking belt loop length C for sewing shape No. 4</b> 	5.0 to 11.0 (mm)	8.0 (mm)
S014	<b>Belt loop length D for sewing shape No. 4 (belt loop loosening amount)</b> 	5.0 to 30.0 (mm)	17.0 (mm)
S015	<b>Linear bartacking belt loop length E for sewing shape No. 4</b> 	-14.0 to 16.0 (mm)	6.0 (mm)

\* : Data marked with an asterisk (\*) are not displayed on the sewing data list screen. They are displayed, however, from the data entry screen.















 : Data in a grey box are not displayed in the standard state. To display them, refer to the Engineer's Manual.

No.	Item		Input range/ selection range	Initial value
S016 *	Zigzag bartacking belt loop length E for sewing shape No. 4		-12.0 to 22.0 (mm)	12.0 (mm)
S017 *	Belt loop length B for sewing shape No. 5		30.0 to 61.0 (mm)	47.0 (mm)
S018 *	Linear bartacking belt loop length C for sewing shape No. 5		5.0 to 11.0 (mm)	8.0 (mm)
S019 *	Zigzag bartacking belt loop length C for sewing shape No. 5		5.0 to 11.0 (mm)	8.0 (mm)
S020 *	Belt loop length D for sewing shape No. 5 (belt loop loosening amount)		2.0 to 8.0 (mm)	3.0 (mm)
S021 *	Linear bartacking belt loop length E for sewing shape No. 5		-2.5 to 7.5 (mm)	2.5 (mm)
S022 *	Zigzag bartacking belt loop length E for sewing shape No. 5		-1.0 to 9.0 (mm)	4.0 (mm)
S023 *	Belt loop length F for sewing shape No. 5		0 to 20.0 (mm)	10.0 (mm)
S024 *	Belt loop length B for sewing shape No. 6		45.0 to 99.0 (mm)	62.0 (mm)
S025 *	Belt loop length C for sewing shape No. 6		15.0 to 30.0 (mm)	17.0 (mm)
S026 *	Linear bartacking belt loop length D for sewing shape No. 6		-2.5 to 7.5 (mm)	2.5 (mm)
S027 *	Zigzag bartacking belt loop length D for sewing shape No. 6		-1.0 to 9.0 (mm)	4.0 (mm)
S028 *	Linear bartacking belt loop length A for sewing shape No. 7		0 to 15.0 (mm)	10.0 (mm)
S029 *	Zigzag bartacking belt loop length A for sewing shape No. 7		0 to 15.0 (mm)	10.0 (mm)
S030 *	Belt loop length B for sewing shape No. 7		30.0 to 63.0 (mm)	40.0 (mm)
S031 *	Linear bartacking belt loop length D for sewing shape No. 7		0 to 10.0 (mm)	4.0 (mm)
S032 *	Zigzag bartacking belt loop length D for sewing shape No. 7		0 to 10.0 (mm)	3.0 (mm)
S033 *	Linear bartacking belt loop length E for sewing shape No. 7		0 to 10.0 (mm)	4.0 (mm)

\* : Data marked with an asterisk (\*) are not displayed on the sewing data list screen. They are displayed, however, from the data entry screen.







 : Data in a gray box are not displayed in the standard state. To display them, refer to the Engineer's Manual.



No.	Item		Input range/ selection range	Initial value
S034 *	<b>Zigzag bartacking belt loop length E for sewing shape No. 7</b>		0 to 10.0 (mm)	3.0 (mm)
S035 *	<b>Linear bartacking belt loop length F for sewing shape No. 7</b>		0 to 20.0 (mm)	10.0 (mm)
S036 *	<b>Zigzag bartacking belt loop length F for sewing shape No. 7</b>		0 to 20.0 (mm)	10.0 (mm)
S037 *	<b>Belt loop loosening amount for sewing shape No. 7</b>		-2.0 to 40.0 (mm)	0 (mm)
S121 *	<b>Belt loop width</b> When the belt loop width is changed, the bartacking width is automatically changed according to the new belt loop width. At this time, the bartacking width out-of-range error (E435) can take place for some set values of the belt loop width.		8.0 to 20.0 (mm)	10.0 (mm)
S122 *	<b>Belt loop length</b>		58.0 to 130.0 (mm)	100.0 (mm)
S131	<b>Clamp position correction in lateral direction</b> This switch is used to correct the lateral position of the belt loop clamp when sewing belt loops.		-3.0 to 3.0 (mm)	0 (mm)
S132	<b>Belt loop clamp longitudinal supply position correction</b> This switch is used to correct the longitudinal position of the belt loop clamp when feeding belt loops.		-5.0 to 5.0 (mm)	0 (mm)
S141	<b>Belt loop tension</b> This switch is used to adjust the belt loop tension that is applied by the belt loop drawing device when the device places the belt loop in sewing position. + : Increases the belt loop tension - : Decreases the belt loop tension → Refer to " I -5-5. Adjusting the belt loop tension", p.24 for details.		-100 to 100	-5
S142	<b>Enable/disable of detection of belt loop drawing device failure</b>  : Enable  : Disable In the case of a light-weight material, disable this function setting.		—	Enable
S143	<b>Belt loop cutter section draw-out correction</b> This function reduces the belt loop draw-out amount to be grasped by the belt loop drawing device immediately after cutting of the belt loop which is not grasped by the drawing device.		-3.0 to 0 (mm)	0 (mm)
S146	<b>Enable/disable of the clamp lower position sensor when sewing the last belt loop</b>  : Enable  : Disable The clamp runs on the garment-body presser when sewing the last part of the belt loop according to the sewing size. In this case, set this item to disable.		—	Enable

\* : Data marked with an asterisk (\*) are not displayed on the sewing data list screen. They are displayed, however, from the data entry screen.

 : Data in a gray box are not displayed in the standard state. To display them, refer to the Engineer's Manual.

No.	Item		Input range/ selection range	Initial value
S147	<b>Fed out amount correction by the clamp amount</b> When setting the belt loop, the length of the fed out belt loop can be corrected by the amount clamped by the belt loop drawing device.		-10.0 to 10.0 (mm)	0 (mm)
S161	<b>Belt loop clamp loosening amount for 1st sewing</b> The amount of belt loop to be loosened by moving the belt loop clamp toward the work clamp of the machine head during the 1st sewing. +: To increase the belt loop loosening amount - : To decrease the belt loop loosening amount		0 to 5.0 (mm)	0 (mm)
S162	<b>Shape Nos. 3, 4, 5, 10, 11, 12: Loosening amount between 1st sewing and 2nd sewing</b> The amount of tension applied to the garment body, for shape Nos. 3, 4, 5, 10, 11 and 12, which is decreased by moving the belt loop clamp from the 2nd sewing position toward you. +: To increase the belt loop loosening amount - : To decrease the belt loop loosening amount		0 to 13.0 (mm)	0 (mm)
S163	<b>Shape Nos. 3, 4, 5, 10, 11, 12: Limit to moving speed of belt loop clamp to 2nd sewing position</b> For shape Nos. 3, 4, 5, 10, 11 and 12, the moving speed of the belt loop clamp to the 2nd sewing position can be limited by means of this switch.		500 to 4000 (pps)	4000 (pps)
S164	<b>Shape Nos. 4, 5, 11, 12: Final sewing position correction in lateral direction of clamp</b> For shape Nos. 4, 5, 11 and 12, the final sewing position can be corrected in lateral direction. Carry out correction in the case the position of the belt loop differs from the position of bartacking. +: Belt loop is moved to the right with respect to the sewing position. - : Belt loop is moved to the left with respect to the sewing position.		-6.0 to 6.0 (mm)	0 (mm)
S165	<b>Shape No. 4, 11: Final sewing position correction in terms of longitudinal direction of clamp</b> For shape Nos. 4 and 11, the distance between the work clamp of machine head and the belt loop clamp at the final sewing position can be decreased by means of this switch. This can reduce the length of remaining thread. <b>Caution: If you excessively move the work clamp foot of the machine head toward the clamp position, the clamp can be stepped over by the work clamp foot. To prevent this, be sure to carefully check the position of those parts before carrying out the adjustment.</b>		-5.0 to 5.0 (mm)	2.0 (mm)
S166	<b>Shape Nos. 4, 5, 11, 12: Limit to moving speed of belt loop clamp to final sewing position</b> For shape Nos. 4, 5, 11 and 12, the moving speed of the belt loop clamp to the final sewing position can be changed by means of this switch.		1000 to 4000 (pps)	4000 (pps)





\* : Data marked with an asterisk (\*) are not displayed on the sewing data list screen. They are displayed, however, from the data entry screen.

: Data in a gray box are not displayed in the standard state. To display them, refer to the Engineer's Manual.

No.	Item	Input range/ selection range	Initial value
S167	<p><b>Garment body feed: Garment body travel amount to far side for the operation to prevent belt loop from being caught</b></p> <p>In the case U507 "operation to prevent the belt loop from being caught" is selected for shape Nos. 3, 4, 5, 10, 11 and 12, this is the travel amount of the garment body to far side before the belt loop clamp travels toward the 2nd sewing position.</p> <p>By changing this period, the belt loop expanding position can be shifted to prevent the belt loop from being caught.</p>	0 to 50.0 (mm)	25.0 (mm)
S168	<p><b>Garment body feed: Belt loop clamp travel standby time for the operation to prevent belt loop from being caught</b></p> <p>In the case U507 "operation to prevent the belt loop from being caught" is selected for shape Nos. 3, 4, 5, 10, 11 and 12, the period of time to retard start of travel of the belt loop clamp toward the 2nd sewing position is specified with respect to the garment body feed.</p> <p>By changing this period, the belt loop expanding position can be shifted to prevent the belt loop from being caught.</p>	0 to 999 (msec)	200 (msec)
S169	<p><b>Shape No. 6: Belt loop clamp loosening amount at 3rd sewing position</b></p> <p>For shape No. 6, the amount of the belt loop to be loosened by moving the belt loop clamp toward you after the clamp has traveled to far side until the 3rd sewing position is reached. This item concerns the aforementioned belt loop loosening amount.</p> <p>Adjust this amount if the garment fabric is pulled or it slackens to exceed the specified dimension between the 3rd sewing position and the fabric edge.</p> <p>+ : To increase the belt loop loosening amount - : To decrease the belt loop loosening amount</p>	0 to 13.0 (mm)	4.0 (mm)
S171	<p><b>Shape Nos. 5, 12: Belt loop rolling position correction in terms of lateral direction of clamp</b></p> <p>For shape Nos. 5 and 12, the position at which the fork is plunged into the final bartacking of the pattern can be corrected in lateral direction of the clamp.</p>	-6.0 to 6.0 (mm)	0 (mm)
S172	<p><b>Shape No. 7: Belt loop rolling position correction in terms of lateral direction of clamp</b></p> <p>The position at which the fork is plunged into the 2nd bartacking of pattern shape No. 7 can be corrected in lateral direction of the clamp.</p>	-6.0 to 6.0 (mm)	0 (mm)
S174	<p><b>Shape Nos. 7, 8, 9: Clamp position correction in lateral direction for clamping and rolling belt loop</b></p> <p>For the shape Nos. 7, 8 and 9, the lateral position of the clamp before the clamp clamps the belt loop and rolls it with the fork is corrected.</p>	-7.0 to 7.0 (mm)	0 (mm)
S176	<p><b>Shape Nos. 7, 9: Belt loop loosening rod insertion position correction</b></p> <p>For the shape Nos. 7 and 9, the insertion position of the belt loop loosening rod is corrected. (The range in which the loosening rod can move has limits. Therefore, the rod may not move to the set position.)</p>	-20.0 to 20.0 (mm)	0 (mm)







\* : Data marked with an asterisk (\*) are not displayed on the sewing data list screen. They are displayed, however, from the data entry screen.

: Data in a gray box are not displayed in the standard state. To display them, refer to the Engineer's Manual.

No.	Item	Input range/ selection range	Initial value
S178	<p><b>Shape No. 7: Belt loop rolling position correction in longitudinal direction of the clamp</b></p> <p>For shape No. 7, this switch is used to correct the longitudinal position of the belt loop clamp when inserting the fork at the 2nd sewing position.</p> 	-3.0 to 3.0 (mm)	0 (mm)
S179	<p><b>Garment body feed: Travel amount to far side for garment body tension reducing operation</b></p> <p>In the case U507 "operation to reduce garment body pulling" is selected for shape Nos. 3, 4, 5, 10, 11 and 12, this is the amount of travel of garment body feed to far side before the feed travels to the 2nd sewing position. By increasing this value, the amount that the belt loop clamp pulls the belt loop while the clamp travels can be decreased. (If this value is excessively increased, the belt loop can come off when the belt loop clamp travels.)</p> 	-10.0 to 10.0 (mm)	0 (mm)
S180	<p><b>Shape No. 7: 2nd sewing position correction in lateral direction of clamp</b></p> <p>For shape No. 7, this switch is used to correct the lateral position of the belt loop clamp at the 2nd sewing position. Carry out the correction if the belt loop position deviates from the sewing position. +: Belt loop is moved to the right with respect to the sewing position. - : Belt loop is moved to the left with respect to the sewing position.</p> 	-6.0 to 6.0 (mm)	0 (mm)
S181	<p><b>Shape Nos. 3, 4, 5, 10, 11, 12: 2nd sewing position correction in lateral direction of clamp</b></p> <p>For shape Nos. 3, 4, 5, 10, 11 and 12, this switch is used to correct the lateral position of the belt loop clamp at the 2nd sewing position. Carry out the correction if the belt loop position deviates from the sewing position. +: Belt loop is moved to the right with respect to the sewing position. - : Belt loop is moved to the left with respect to the sewing position.</p> 	-3.0 to 3.0 (mm)	0 (mm)
S182	<p><b>Shape Nos. 2, 6: 2nd sewing position correction in lateral direction of clamp</b></p> <p>For shape Nos. 2 and 6, this switch is used to correct the lateral position of the belt loop clamp at the 2nd sewing position. Carry out the correction if the belt loop position deviates from the sewing position. +: Belt loop is moved to the right with respect to the sewing position. - : Belt loop is moved to the left with respect to the sewing position.</p> 	-3.0 to 3.0 (mm)	0 (mm)

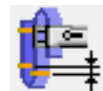





\* : Data marked with an asterisk (\*) are not displayed on the sewing data list screen. They are displayed, however, from the data entry screen.

: Data in a gray box are not displayed in the standard state. To display them, refer to the Engineer's Manual.

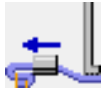
No.	Item		Input range/ selection range	Initial value
S183	<p><b>Shape No. 6: 3rd sewing position correction in lateral direction of clamp</b></p> <p>For shape No. 6, this switch is used to correct the lateral position of the belt loop clamp at the 3rd sewing position.</p> <p>Carry out the correction if the belt loop position deviates from the sewing position.</p> <p>+ : Belt loop is moved to the right with respect to the sewing position.</p> <p>- : Belt loop is moved to the left with respect to the sewing position.</p>		-3.0 to 3.0 (mm)	0 (mm)
S184	<p><b>Shape Nos. 5, 7, 12: Belt loop rolling position correction in terms of lateral direction of clamp</b></p> <p>For shape Nos. 5, 7 and 12, this is the amount of lateral travel of the belt loop clamp before removing the fork from the belt loop.</p>		-6.0 to 6.0 (mm)	0 (mm)
S185	<p><b>Shape Nos. 7, 9: Loosening amount after releasing rod has moved, in terms of longitudinal direction of clamp</b></p> <p>For shape Nos. 7 and 9, it is the amount by which the garment-body tension is reduced by moving the belt loop clamp forward after having moved it to far side to allow the belt loop releasing rod can be inserted.</p>		0 to 13.0 (mm)	0 (mm)
S186	<p><b>Shape No. 6: Loosening amount between the 2nd and 3rd sewing positions</b></p> <p>This is the loosening amount of the garment body tension during the travel to the 3rd sewing position by operating the garment body feed before the travel to the 3rd sewing position.</p> <p>+ : To increase the belt loop loosening amount</p> <p>- : To decrease the belt loop loosening amount</p>		0 to 40.0 (mm)	25.0 (mm)
S187	<p><b>Shape Nos. 7, 9: Speed limitation of travel to lower bartacking position</b></p> <p>For shape Nos. 7 and 9, the speed of the clamp when it travels to the 2nd sewing position can be limited.</p>		1000 to 4000 (pps)	4000 (pps)
S189	<p><b>Shape Nos. 3, 4, 5, 10, 11, 12: Correction of longitudinal position of belt loop clamp at 2nd sewing position</b></p> <p>For shape Nos. 3, 4, 5, 10, 11 and 12, this switch is used to correct the longitudinal position of the belt loop clamp when lowering the work clamp of the machine head at the 2nd sewing position.</p>		-3.0 to 3.0 (mm)	0 (mm)
S190	<p><b>Shape Nos. 4, 5: Correction of amount of moving belt loop clamp to far side during 2nd sewing</b></p> <p>For shape Nos. 4 and 5, this switch is used to correct the amount of moving the belt loop clamp to far side during 2nd sewing.</p>		-20.0 to 20.0 (mm)	0 (mm)
S191	<p><b>Manual pedal use: Amount of moving garment body feed backward after garment body presser has come down</b></p> <p>In the case the manual pedal has been programmed by the device setting data so that the front and rear garment body pressers are driven separately and the garment body feed travel is enabled after the garment body presser has come down, this is the amount of travel of the garment body feed after the garment body presser has come down.</p> <p>→ Refer to "<a href="#">II-2-29. How to set the device</a>", p.98 for details of the device setting data changing procedure.</p>		0 to 20.0 (mm)	10.0 (mm)

















\* : Data marked with an asterisk (\*) are not displayed on the sewing data list screen. They are displayed, however, from the data entry screen.

: Data in a gray box are not displayed in the standard state. To display them, refer to the Engineer's Manual.

No.	Item	Input range/ selection range	Initial value
S194	<p><b>Shape Nos. 10, 11, 12: Belt loop clamping position shifting function</b></p> <p>For shape Nos. 10, 11 and 12, this switch is used to select the function that shifts the belt loop clamping position by moving the clamp with the belt loop pressed by the work clamp foot after the 2nd sewing.</p>  : Automatic Enable/disable of the belt loop clamping position shifting operation is automatically changed over according to the set value of the belt loop dimension.  : Enable The belt-loop clamping position shifting operation is carried out at all times.  : Disable The belt-loop clamping position shifting operation is not carried out.	—	Automatic
S195	<p><b>Shape Nos. 10, 11, 12: 3rd sewing position correction in terms of longitudinal direction of clamp</b></p>  <p>For shape Nos. 10, 11 and 12, the 3rd sewing position of the clamp can be corrected in longitudinal direction.</p>	-20.0 to 20.0 (mm)	0 (mm)
S196	<p><b>Shape Nos. 10, 11, 12: Garment-body feed 3rd sewing position correction</b></p>  <p>For shape Nos. 10, 11 and 12, the 3rd sewing position of the garment body feed can be corrected.</p> <p><b>Caution: If this sewing data is changed, dimension B and dimension D will change.</b></p>	-3.0 to 3.0 (mm)	0 (mm)
S197	<p><b>Shape Nos. 10, 11, 12: Belt loop clamping position correction in terms of longitudinal direction of clamp</b></p>  <p>For shape Nos. 10, 11 and 12, the clamp position at the time when the belt loop is pressed by the work clamp foot can be corrected in longitudinal direction, while the belt-loop clamping position shifting function is enabled.</p>	-15.0 to 15.0 (mm)	0 (mm)
S198	<p><b>Shape Nos. 10, 11, 12: Garment-body feed belt-loop clamping position correction</b></p>  <p>For shape Nos. 10, 11 and 12, the garment body feed position at the time when the belt loop is pressed by the work clamp foot can be corrected while the belt-loop grasping position shifting function is enabled.</p>	-15.0 to 15.0 (mm)	0 (mm)
S199	<p><b>Shape Nos. 10, 11, 12: Belt-loop clamping position shifting amount correction in terms of longitudinal direction of clamp</b></p>  <p>For shape Nos. 10, 11 and 12, the belt-loop clamping position shifting amount by moving the clamp to the far side after the work clamp foot presses the belt-loop can be corrected, while the belt-loop grasping position shifting function is enabled.</p>	-10.0 to 20.0 (mm)	0 (mm)

















\* : Data marked with an asterisk (\*) are not displayed on the sewing data list screen. They are displayed, however, from the data entry screen.

 : Data in a gray box are not displayed in the standard state. To display them, refer to the Engineer's Manual.

No.	Item	Input range/ selection range	Initial value	
S203	<p><b>Shape Nos. 7, 8, 9: Belt-loop status selection when correcting the position at which belt-loop clamp rolls belt loop</b></p> <p>The belt-loop status when the clamp position is changed by means of S174 "Shape Nos. 7, 8 and 9: Belt-loop rolling position correction in lateral direction of clamp" can be selected.</p>  : Clamp is moved with the belt-loop tensed.  : Clamp is moved with one side of belt-loop cut.	—	Tensed state of the belt loop	
S221 *	Belt loop length B for sewing shape No. 8		45.0 to 109.0 (mm)	80.0 (mm)
S222 *	Linear bartacking belt loop length D for sewing shape No. 8		0 to 10.0 (mm)	4.0 (mm)
S223 *	Zigzag bartacking belt loop length D for sewing shape No. 8		0 to 10.0 (mm)	3.0 (mm)
S224 *	Belt loop length B for sewing shape No. 9		30.0 to 60.0 (mm)	40.0 (mm)
S225 *	Linear bartacking belt loop length D for sewing shape No. 9		0 to 10.0 (mm)	4.0 (mm)
S226 *	Zigzag bartacking belt loop length D for sewing shape No. 9		0 to 10.0 (mm)	3.0 (mm)
S227 *	Linear bartacking belt loop length E for sewing shape No. 9		-14.0 to 16.0 (mm)	6.0 (mm)
S228 *	Zigzag bartacking belt loop length E for sewing shape No. 9		-12.0 to 22.0 (mm)	12.0 (mm)
S229 *	Belt loop loosening amount for sewing shape No. 9		2.0 to 30.0 (mm)	17.0 (mm)
S230 *	Belt loop length B for sewing shape No. 10		45.0 to 109.0 (mm)	79.0 (mm)
S231 *	Linear bartacking belt loop length C for sewing shape No. 10		5.0 to 11.0 (mm)	8.0 (mm)
S232 *	Zigzag bartacking belt loop length C for sewing shape No. 10		5.0 to 11.0 (mm)	8.0 (mm)
S233 *	Linear bartacking belt loop length D for sewing shape No. 10		0 to 4.0 (mm)	4.0 (mm)
S234 *	Zigzag bartacking belt loop length D for sewing shape No. 10		0 to 4.0 (mm)	3.0 (mm)

\* : Data marked with an asterisk (\*) are not displayed on the sewing data list screen. They are displayed, however, from the data entry screen.







 : Data in a gray box are not displayed in the standard state. To display them, refer to the Engineer's Manual.

No.	Item		Input range/ selection range	Initial value
S235 *	Belt loop length B for sewing shape No. 11		30.0 to 50.0 (mm)	40.0 (mm)
S236 *	Linear bartacking belt loop length C for sewing shape No. 11		5.0 to 11.0 (mm)	8.0 (mm)
S237 *	Zigzag bartacking belt loop length C for sewing shape No. 11		5.0 to 11.0 (mm)	8.0 (mm)
S238 *	Linear bartacking belt loop length D for sewing shape No. 11		0 to 4.0 (mm)	4.0 (mm)
S239 *	Zigzag bartacking belt loop length D for sewing shape No. 11		0 to 4.0 (mm)	3.0 (mm)
S240 *	Linear bartacking belt loop length E for sewing shape No. 11		-14.0 to 16.0 (mm)	6.0 (mm)
S241 *	Zigzag bartacking belt loop length E for sewing shape No. 11		-12.0 to 22.0 (mm)	12.0 (mm)
S242 *	Belt loop loosening amount for sewing shape No. 11		2.0 to 30.0 (mm)	17.0 (mm)
S243 *	Belt loop length B for sewing shape No. 12		30.0 to 56.0 (mm)	47.0 (mm)
S244 *	Linear bartacking belt loop length C for sewing shape No. 12		5.0 to 11.0 (mm)	8.0 (mm)
S245 *	Zigzag bartacking belt loop length C for sewing shape No. 12		5.0 to 11.0 (mm)	8.0 (mm)
S246 *	Linear bartacking belt loop length D for sewing shape No. 12		0 to 4.0 (mm)	4.0 (mm)
S247 *	Zigzag bartacking belt loop length D for sewing shape No. 12		0 to 4.0 (mm)	3.0 (mm)
S248 *	Linear bartacking belt loop length E for sewing shape No. 12		-2.5 to 7.5 (mm)	2.5 (mm)
S249 *	Zigzag bartacking belt loop length E for sewing shape No. 12		-1.0 to 9.0 (mm)	4.0 (mm)
S250 *	Belt loop length F for sewing shape No. 12		0 to 20.0 (mm)	10.0 (mm)
S251 *	Belt loop loosening amount for sewing shape No. 12		2.0 to 16.0 (mm)	6.0 (mm)

\* : Data marked with an asterisk (\*) are not displayed on the sewing data list screen. They are displayed, however, from the data entry screen.

 : Data in a gray box are not displayed in the standard state. To display them, refer to the Engineer's Manual.



No.	Item		Input range/ selection range	Initial value
S280	<p><b>Shape No. 9: 2nd sewing position correction in lateral direction of clamp</b></p> <p>For shape No. 9, this switch is used to correct the lateral position of the belt loop clamp at the 2nd sewing position.</p> <p>Carry out correction in the case the position of the belt loop differs from the position of bartacking.</p> <p>+ : Belt loop is moved to the right with respect to the sewing position.</p> <p>- : Belt loop is moved to the left with respect to the sewing position.</p>		-6.0 to 6.0 (mm)	0 (mm)
S281	<p><b>Shape No. 9: 2nd sewing position correction in longitudinal direction of clamp</b></p> <p>For shape No. 9, the distance between the work clamp of machine head and the belt loop clamp at the 2nd sewing position can be decreased by means of this switch. This can reduce the length of remaining thread.</p> <p><b>Caution: If you excessively move the work clamp foot of the machine head toward the clamp position, the clamp can be stepped over by the work clamp foot. To prevent this, be sure to carefully check the position of those parts before carrying out the adjustment.</b></p>		-5.0 to 5.0 (mm)	2.0 (mm)
S282	<p><b>Shape Nos. 11, 12: Clamp speed limitation when moving to the loosening rod insertion position</b></p> <p>For shape Nos. 11 and 12, the speed of the clamp, which is employed when it moves to the far side after the completion of 3rd sewing in order to insert the loosening rod, can be limited.</p>		1000 to 4000 (pps)	4000 (pps)
S283	<p><b>Shape Nos. 10, 11, 12: 3rd sewing position correction in lateral direction of clamp</b></p> <p>For shape Nos. 10, 11 and 12, the 3rd sewing position can be corrected in lateral direction.</p> <p>Carry out correction in the case the position of the belt loop differs from the position of bartacking.</p> <p>+ : Belt loop is moved to the right with respect to the sewing position.</p> <p>- : Belt loop is moved to the left with respect to the sewing position.</p>		-6.0 to 6.0 (mm)	0 (mm)
S284	<p><b>Shape Nos. 10, 11, 12: Loosening amount after travel to 3rd sewing position in terms of longitudinal direction of clamp</b></p> <p>For shape Nos. 10, 11 and 12, this is the loosening amount of the garment body tension by moving the clamp from the 3rd sewing position to the far side.</p> <p>+ : To increase the belt loop loosening amount</p> <p>- : To decrease the belt loop loosening amount</p>		0 to 13.0 (mm)	0 (mm)
S285	<p><b>Shape Nos. 10, 11, 12: Limit to moving speed of belt loop clamp to 3rd sewing position</b></p> <p>For shape Nos. 3, 4, 5, 10, 11 and 12, the moving speed of the belt loop clamp to the 3rd sewing position can be limited by means of this switch.</p>		1000 to 4000 (pps)	4000 (pps)
S286	<p><b>Shape No. 6: Limit to moving speed of belt loop clamp to 3rd sewing position</b></p> <p>For shape No. 6, the moving speed of the belt loop clamp to the 3rd sewing position can be limited by means of this switch.</p>		1000 to 4000 (pps)	4000 (pps)

\* : Data marked with an asterisk (\*) are not displayed on the sewing data list screen. They are displayed, however, from the data entry screen.

: Data in a gray box are not displayed in the standard state. To display them, refer to the Engineer's Manual.

## 2-28. How to change the memory switch data

### (1) Method for changing the memory switch data

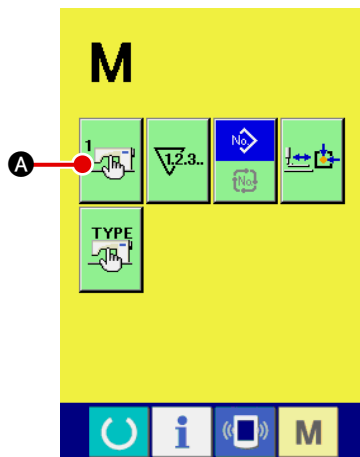

#### ① Displaying the memory switch data list screen

When you press mode changeover key **M**, memory switch

data button  **A** is displayed on the screen. When you press this button, the memory switch data list screen is displayed.

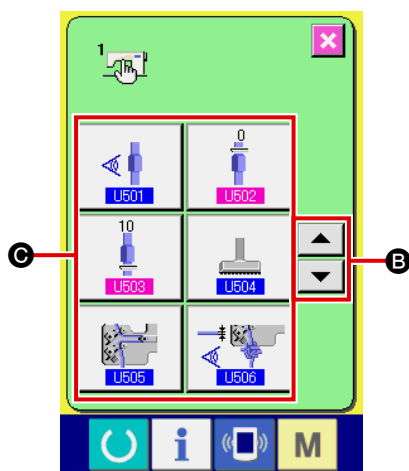

#### ② Selecting the memory switch data button data of which you want to change

Press up/down scroll buttons  **B** to select data item button **C** data of which you want to change.

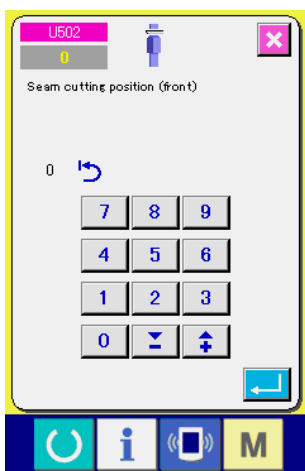

#### ③ Changing the memory switch data

There are two types of memory switch data according to the data changing method; one is changed by changing figures and the other is changed by selecting a pictograph.

For data items data of which are changed with figures are assigned with a number in pink as **U502**.

For these items, set values can be changed with the numeric keys and +/- buttons displayed on the data change screen.



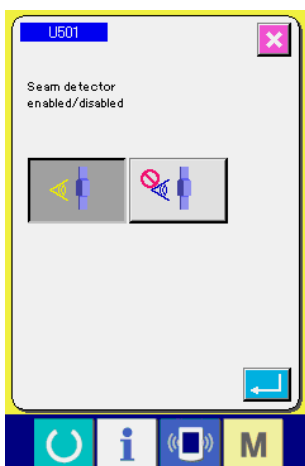

For data items data of which are changed by selecting a pictograph are assigned with a number in blue as **U501**.







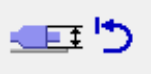







For these data items, a pictograph can be selected from those displayed on the screen.







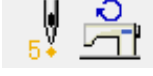



\* Refer to (2) Memory switch data list for details of the memory switch data.

## (2) Memory switch data list

No.	Item	Input range/ selection range	Initial value
U501	<p><b>Multi-layered part detecting function enabled/disabled</b> Enable/disable of the multi-layered part detecting function is selected with this switch.</p>  <p style="text-align: center;">Enable                  Disable</p>	—	Enable
U502	<p><b>Multi-layered part cutting position (front)</b> In the case, when the top of seam (i.e. joint) of a belt loop is detected, the part of the belt-loop before the detected seam is to be cut as a defective part, the length of the part of the belt-loop to be cut is entered with this switch (in mm). Since the area around the seam is likely to bulge gradually toward the seam, accuracy of the seam detection varies according to the belt-loop material. This switch is provided to compensate the detection accuracy. In addition, this switch sometimes has to be adjusted according to the belt-loop width. * The front-side trimming of the multi-layered part is only enabled when the front/rear is selected for the multi-layered part trimming position. (memory switch level 2 K551). Refer to the Engineer's Manual for the memory switch level 2. In the initial state, the front part of the belt-loop is not cut.</p> 	0 to 99 (mm)	10 (mm)
U503	<p><b>Seam cutting position (rear)</b> The length of a belt-loop from the rear end of a seam to the belt-loop cutting position is set with this parameter (in mm). Since the area around the seam is likely to bulge gradually toward the seam, accuracy of the seam detection varies according to the belt-loop material. Adjust this parameter to around 10 to adjust the aforementioned length to approximately 10 mm according to the belt-loop material. If this length has no allowance, the seam may remain on the belt loop.</p> 	0 to 99 (mm)	10 (mm)
U504	<p><b>Belt-loop multi-layered part detection display initial value</b> This switch is used to set the initial value to determine the multi-layered part of a belt loop for the newly created belt loop pattern. → Refer to "<a href="#">II-2-13. Belt loop teaching function</a>", <a href="#">p.53</a> for details.</p> 	0 to 255	70
U505	<p><b>Belt-loop no-insertion detection display initial value</b> This switch is used to set the initial value to determine no-belt-loop state for the newly created belt loop pattern. → Refer to "<a href="#">II-2-13. Belt loop teaching function</a>", <a href="#">p.53</a> for details.</p> 	0 to 255	0

No.	Item	Input range/ selection range	Initial value
U506	<p><b>Belt loop clamp standby at intermediate position:</b>  <b>Selection of longitudinal position</b>            With this switch, the standby position of the belt loop clamp in terms of longitudinal direction at the intermediate standby position can be selected.            If the far-side is selected, the operator has a wider space to handle the sewing product.</p> <div style="display: flex; justify-content: space-around; align-items: center;"> <div style="text-align: center;">               Standard           </div> <div style="text-align: center;">               Far           </div> </div>	—	Standard
U507	<p><b>Shape Nos. 3, 4, 5, 10, 11, 12: Selection of travel method to second sewing position</b>            For the shape Nos. 3, 4, 5, 10, 11 and 12, the method to move the clamp and the garment-body presser to the second sewing position is selected.</p> <div style="display: flex; justify-content: space-between;"> <div style="width: 30%;">  </div> <div> <p>Standard: Standard quick operation</p> </div> </div> <div style="display: flex; justify-content: space-between; margin-top: 10px;"> <div style="width: 30%;">  </div> <div> <p>Operation to reduce garment body pulling: Select this setting when the belt loop is excessively floated by being pulled by the garment body.</p> </div> </div> <div style="display: flex; justify-content: space-between; margin-top: 10px;"> <div style="width: 30%;">  </div> <div> <p>Operation to prevent the belt loop from being caught: Select this setting when the expanded belt loop interferes with the work clamp of the machine head or the needle.</p> </div> </div>	—	Standard
U508	<p><b>Belt loop width/bartacking width interlocking function</b>            This is the function that automatically changes the bartacking width when the belt-loop width is changed according to the change rate of the latter.</p> <div style="display: flex; justify-content: space-around; align-items: center; margin-bottom: 10px;">  <span>: Enable</span> </div> <div style="display: flex; justify-content: space-around; align-items: center;">  <span>: Disable</span> </div>	—	Enable
U001	<p><b>Maximum sewing speed</b></p> 	400 to 2500	2500
U002	<p><b>Sewing speed of 1st stitch</b>            In case of with thread clamp</p> 	400 to 1500	1000
U003	<p><b>Sewing speed of 2nd stitch</b>            In case of with thread clamp</p> 	400 to 2500	1500
U004	<p><b>Sewing speed of 3rd stitch</b>            In case of with thread clamp</p> 	400 to 2500	2500
U005	<p><b>Sewing speed of 4th stitch</b>            In case of with thread clamp</p> 	400 to 2500	2500
U006	<p><b>Sewing speed of 5th stitch</b>            In case of with thread clamp</p> 	400 to 2500	2500
U007	<p><b>Thread tension of 1st stitch</b>            In case of with thread clamp</p> 	0 to 200	200

No.	Item		Input range/ selection range	Initial value
U008	<b>Thread tension setting at the time of thread trimming</b>		0 to 200	0
U009	<b>Thread tension changeover timing at the time of thread trimming</b> In case of with thread clamp		-6 to 4	0
U010	<b>Sewing speed of 1st stitch</b> In case of without thread clamp		400 to 1500	400
U011	<b>Sewing speed of 2nd stitch</b> In case of without thread clamp		400 to 2500	900
U012	<b>Sewing speed of 3rd stitch</b> In case of without thread clamp		400 to 2500	2500
U013	<b>Sewing speed of 4th stitch</b> In case of without thread clamp		400 to 2500	2500
U014	<b>Sewing speed of 5th stitch</b> In case of without thread clamp		400 to 2500	2500
U015	<b>Thread tension of 1st stitch</b> In case of without thread clamp		0 to 200	0
U016	<b>Thread tension changeover timing at the time of sewing start</b> In case of without thread clamp		-5 to 2	-5
U030	<b>Selection of reference point for pattern enlargement/reduction</b>	 Origin  Sewing starting point	—	Origin
U032	<b>Buzzer sound can be prohibited</b>	 Without buzzer sound  Panel operating sound  Panel operating sound + error	—	Panel operating sound + error
U033	<b>Number of stitches of thread clamp can be delayed</b>		1 to 7 (Stitch)	2
U034	<b>Clamping timing of thread clamp can be delayed</b>		-10 to 0	0
U035	<b>Thread clamp control can be prohibited</b>	 Normal  Prohibited	—	Normal
U036	<b>Feed motion timing is selected</b> Set the timing in "-" direction when stitch is not well-tightened.		-8 to 16	0
U049	<b>Bobbin winding speed can be set</b>		800 to 2000	1600

No.	Item	Input range/ selection range	Initial value																
U071	<b>Thread breakage detection selection</b>   Thread breakage detection invalid    Thread breakage detection valid	—	Valid																
U072	<b>Number of invalid stitches at the start of sewing of thread breakage detection</b>		0 to 15 (stitches)																
U073	<b>Number of invalid stitches at the end of sewing of thread breakage detection</b>		0 to 15 (stitches)																
U074	<b>Re-sewing function after thread breakage</b> This is the function that re-starts sewing of belt loops from the position where the machine has stopped by the detection of thread breakage.  : Enable (Sewing is re-started by means of the start switch after resetting the sewing machine on the thread breakage detection error screen.)  : Disable (The screen is returned to the data entry screen by resetting the sewing machine on the thread breakage error detection screen.)	—	Enable																
U239	<b>Language selection</b> <table border="0" style="width: 100%; text-align: center;"> <tr> <td>日本語 Japanese</td> <td>English English</td> <td>中文繁體字 Chinese (traditional)</td> <td>中文简体字 Chinese (simplified)</td> </tr> <tr> <td>Español Spanish</td> <td>Italiano Italian</td> <td>Français French</td> <td>Deutsch German</td> </tr> <tr> <td>Português Portuguese</td> <td>Türkçe Turkish</td> <td>Tiếng Việt Vietnamese</td> <td>한국어 Korean</td> </tr> <tr> <td>Indonesia Indonesian</td> <td>Русский Russian</td> <td></td> <td></td> </tr> </table>	日本語 Japanese	English English	中文繁體字 Chinese (traditional)	中文简体字 Chinese (simplified)	Español Spanish	Italiano Italian	Français French	Deutsch German	Português Portuguese	Türkçe Turkish	Tiếng Việt Vietnamese	한국어 Korean	Indonesia Indonesian	Русский Russian			—	English
日本語 Japanese	English English	中文繁體字 Chinese (traditional)	中文简体字 Chinese (simplified)																
Español Spanish	Italiano Italian	Français French	Deutsch German																
Português Portuguese	Türkçe Turkish	Tiếng Việt Vietnamese	한국어 Korean																
Indonesia Indonesian	Русский Russian																		
U245	<b>Grease-up error clear</b> Clearing of number of stitches of grease-up is performed. → Refer to " <a href="#">III-1-16. Replenishing the designated places with grease</a> ", p.138.		—																
U269	<b>Grease-up error clear</b> Number of belt-loops to be sewn with grease run-out state is cleared. → Refer to " <a href="#">III-1-16. Replenishing the designated places with grease</a> ", p.138.		—																

## 2-29. How to set the device

### (1) Device setting changing procedure

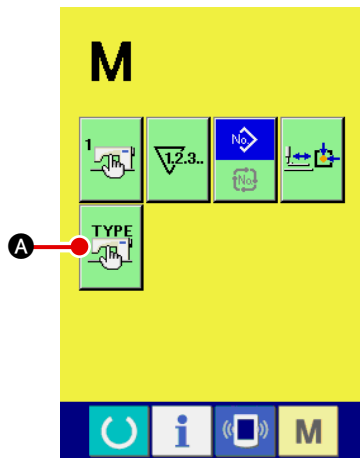

#### ① Displaying the device setting screen

Press the **M** switch, and device setting button  **A** will be displayed on the screen. When you press this button, the device setting screen is displayed.

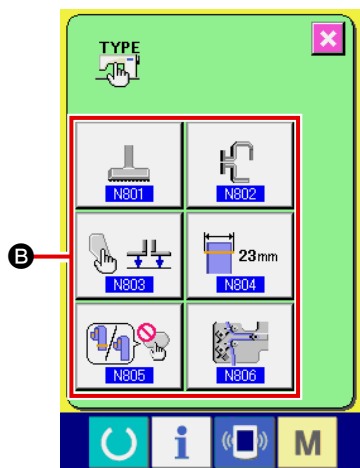

#### ② Selecting the memory switch button setting of which is to be changed

Select data item **B** setting of which you want to change.

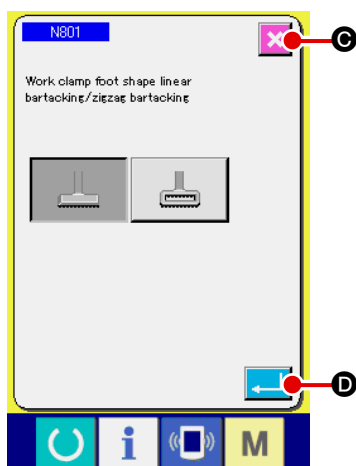







#### ③ Changing data

Data items are assigned with No. such as **N801** displayed in blue. The pictograph to be displayed on the data changing screen can be selected.





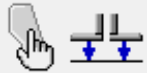
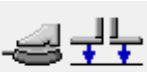

When you press enter button  **D**, the data is confirmed.

When you press cancel button  **C**, the changed data is not updated.

**(2) Listing of the device settings**

No.	Item	Input range/ selection range	Initial value
<p><b>N801</b></p>	<p><b>Work clamp foot shape</b> The shape of the work clamp foot of the sewing machine to be used is set. Parameters to be displayed, and the operation of the sewing machine and belt-loop clamp change over according to the selected work clamp foot shape. The setting of the work clamp foot should match the shape of the work clamp foot actually mounted on the sewing machine.</p> <div style="display: flex; justify-content: space-around; align-items: center;"> <div style="text-align: center;">  <p>Linear bartacking</p> </div> <div style="text-align: center;">  <p>Zigzag bartacking</p> </div> </div> <p><b>Caution:</b> When you select the "linear bartacking," the standard bartacking patterns 7 to 9 cannot be selected.</p> <div style="border: 1px dashed black; padding: 5px; margin-top: 10px;"> <p> <b>If the machine performs sewing with the "zigzag bartacking" selected with the linear bartacking presser is mounted on the sewing machine, the needle may break.</b></p> </div>	—	Linear bartacking
<p><b>N802</b></p>	<p><b>Selection of the garment-body presser shape</b> With/without of the auxiliary clamp for the garment-body presser is selected. The setting should match the shape of the garment-body presser actually mounted on the sewing machine.</p> <div style="display: flex; justify-content: space-around; align-items: center;"> <div style="text-align: center;">  <p>With the auxiliary clamp</p> </div> <div style="text-align: center;">  <p>Without the auxiliary clamp</p> </div> </div> <p><b>Caution:</b> The belt-loop patterns of shape Nos. 2 and 6 cannot be sewing with the auxiliary clamp installed. In the case "With the auxiliary clamp" is selected, "E478 Belt-loop shape/garment-body presser shape mismatch error" will occur when one of those belt-loop pattern shapes is selected and the set ready key is pressed. If the error has occurred, select "Without the auxiliary clamp" with the auxiliary clamp removed.</p>	—	With the auxiliary clamp
<p><b>N803</b></p>	<p><b>Manual function</b> The operation of the manual pedal (optional) is selected. If the manual pedal is used, the garment-body presser can be manually operated. Refer to the Engineer's Manual for details</p> <div style="margin-top: 10px;"> <p> : Manual pedal is not used</p> <p> : Simultaneous operation of the front/rear garment-body pressers</p> <p> : Separate operation of the front/rear garment-body pressers</p> <p> : Separate operation of the front/rear garment-body pressers. The garment-body is moved.</p> </div>	—	Manual pedal is not used



No.	Item	Input range/ selection range	Initial value
<b>N804</b>	<p><b>Limitation to input of X-direction of bartacking</b></p> <p>It is possible to restrict the input of X-direction data on the bartacking.</p> <p>In the case the narrow-width throat plate (optional) is used, 14 mm should be selected.</p> <div style="display: flex; justify-content: space-around; align-items: flex-start;"> <div style="text-align: center;">  <p>23 mm (standard throat plate)</p> </div> <div style="text-align: center;">  <p>14 mm (narrow-width throat plate)</p> </div> </div>	—	23 mm
<b>N805</b>	<p><b>Third bartack cancellation switch function</b></p> <p>Use/disuse of the third bartack cancellation switch (optional) is selected.</p> <p>Refer to the Engineer's Manual for details.</p> <div style="display: flex; justify-content: space-around; align-items: center;"> <div style="text-align: center;">  <p>Disuse</p> </div> <div style="text-align: center;">  <p>Use</p> </div> </div>	—	Disuse
<b>N806</b>	<p><b>Feeding device operation/stop changeover</b></p> <p>Operation/stop of the feeding device (optional) is selected.</p> <div style="display: flex; justify-content: space-around; align-items: center;"> <div style="text-align: center;">  <p>Stop</p> </div> <div style="text-align: center;">  <p>Operation</p> </div> </div>	—	Stop

## 2-30. How to adjust the origin of work clamp foot

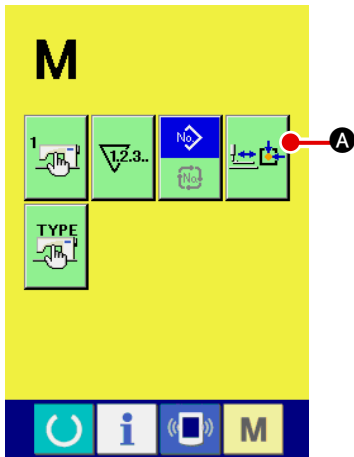

- ① Displaying the work clamp foot origin adjustment screen**

When you press the mode changeover key **M**, work clamp foot origin adjustment button  **A** is displayed. When you press this button, the work clamp foot origin adjustment screen is displayed.

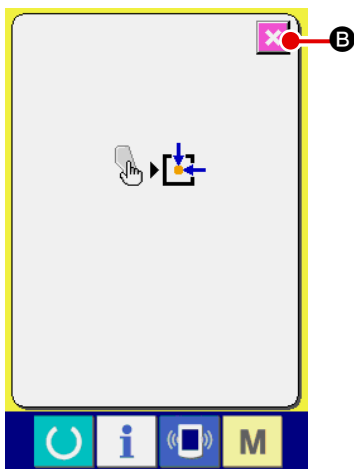

- ② Adjusting the origin of the work clamp foot**

Retrieve the origin with the start switch.  
When you press cancel button  **B**, the work clamp foot origin adjustment screen is closed and the mode screen is displayed.



## 2-31. Using communication function

Communication function can download the sewing data created with other sewing machine, creation of sewing data and sewing data created by editing device PM-1 to the sewing machine. Furthermore, the above data can be uploaded to a media.

As the means of communication, a media slot and USB port are prepared.

### (1) Handling possible data

Sewing data that can be handled are 2 kinds below, and the respective data formats are as shown below.

Data name		Extension	Description of data
Vector format data		VD000XXX.VDT	It is the data of needle entry point created with PM-1, and the data format that can be operated in common between JUKI sewing machines.
Sewing data		AB00XXX.EPD	Exclusive sewing data for AB model of the sewing machine created with the sewing machine.

XXX: File No.

### (2) Performing communication by using the media

For handling way of the media, read "[II-1. INTRODUCTION](#)", p.27.

### (3) Performing communication by using USB

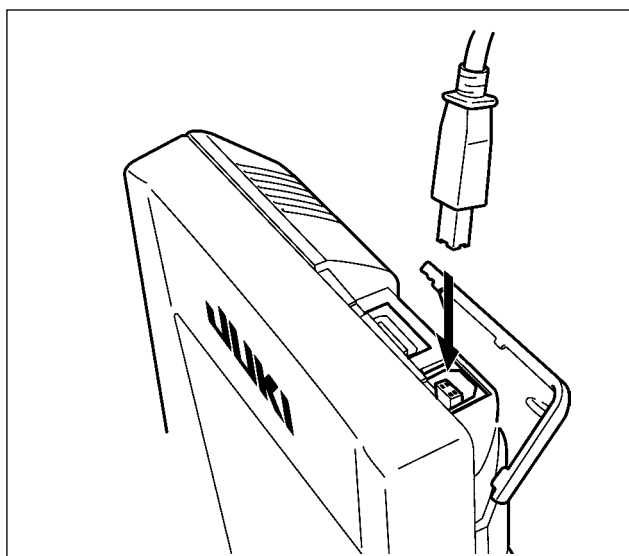

Data can be sent/received to/from a personal computer or the like, by means of a USB cable.



If the contact part becomes dirty, failure of contact will be caused. Do not touch by hand, and control so that dust, oil or other foreign material does not adhere to it. In addition, the inside element is damaged by static electricity or the like. So, be very careful when handling.

#### (4) Take-in of the data

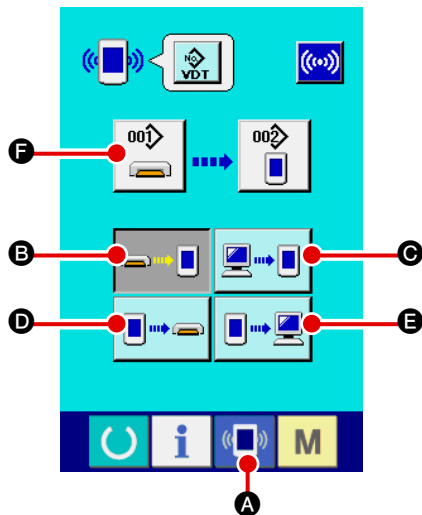

##### ① Display the communication screen

When communication switch  (A) of switch seat section is pressed in the data input screen, the communication screen is displayed.

##### ② Select the communication procedure

There are four communication procedures as described below.

- Ⓑ Writing data from media to panel
- Ⓒ Writing data from personal computer (server) to panel
- Ⓓ Writing data from panel to media
- Ⓔ Writing data from panel to personal computer (server)

Select the button of communication procedure you desire.

##### ③ Select the data No.

When  (F) is pressed, the writing file selection screen is displayed.

Input the file No. of the data you desire to write. For the file No., input the numerals of the part xxx of VD00xxx.vdt of the file name.

Designation of the pattern No. of writing destination can be performed in the same way. When the writing destination is the panel, pattern Nos. which have not been registered are displayed.

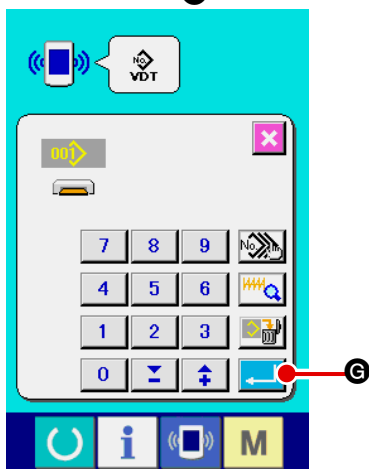



##### ④ Determine the data No.

When ENTER button  (G) is pressed, the data No. selection screen is closed and the selection of the data No. has been completed.

##### ⑤ Start communication

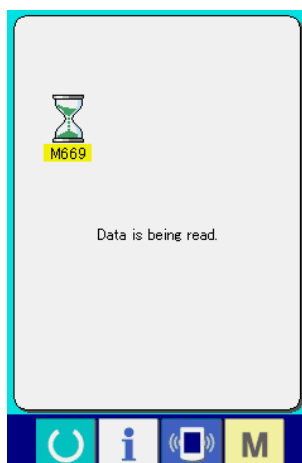
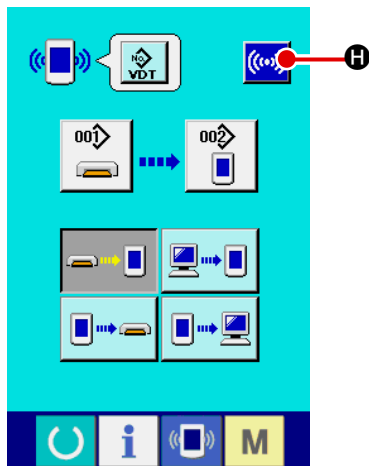
When COMMUNICATION START button  (H) is pressed, the data communication starts. The during communication screen is displayed during communication and the screen returns to the communication screen after the end of communication.



 **Do not open the cover during reading the data. Data may not be read in.**

## (5) Taking in plural data together

It is possible for vector data, sewing data to select plural writing data and write them together. Pattern No. of writing destination will become the same No. of the selected data No.



**It is not possible for the No. after No. 201 of media to select plural No.**

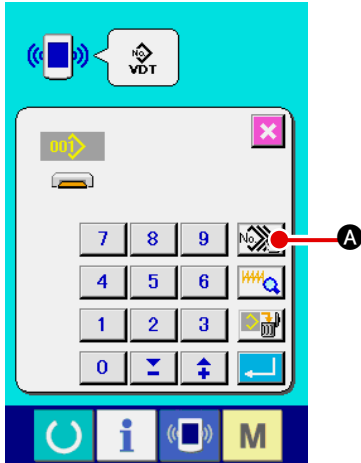

### ① Display the writing file selection screen

When PLURAL SELECTION button  **A** is pressed, the data No. plural selection screen is displayed.

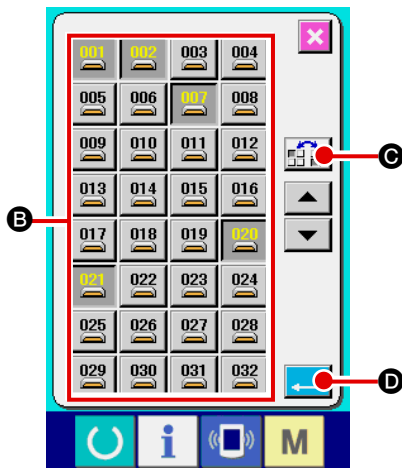

### ② Perform the data No. selection

Since the list of existing data file numbers is displayed, press FILE NO. button **B** you desire to write. It is possible to invert the selected state of the button with INVERSION button  **C**.

### ③ Determine the data No.

When ENTER button  **D** is pressed, the data No. plural selection screen is closed and the data selection ends.

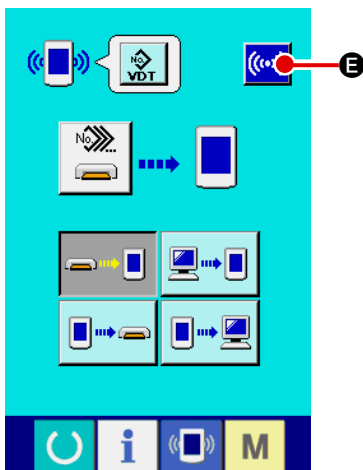

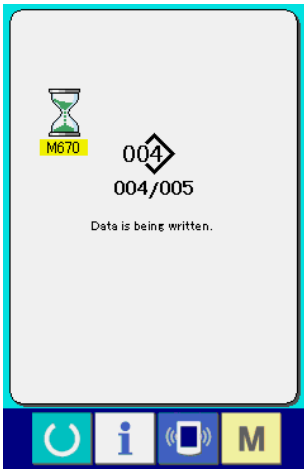

### ④ Start the communication

When COMMUNICATION START button  **E** is pressed, the data communication starts.

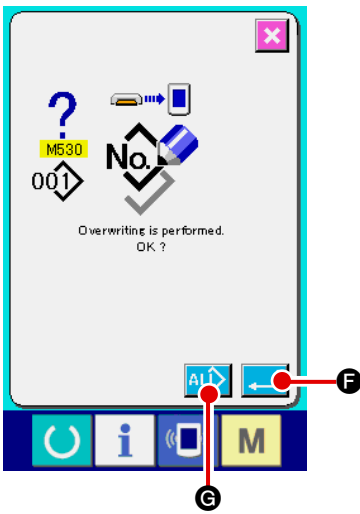

Data No. during communication, total number of writing data and number of data that have ended the data communication are displayed in the during communication screen.



- \* When performing writing the pattern No. which already exists, the overwriting confirmation screen is displayed before writing. When performing overwriting, press ENTER button  **F**. When performing overwriting all without displaying the overwriting confirmation screen, press OVERWRITING button  **E** in all cases.

## 2-32. Performing formatting of the media

To re-format a medium, the IP-420 has to be used. The IP-420 is not able to ready any medium which is formatted on a personal computer.

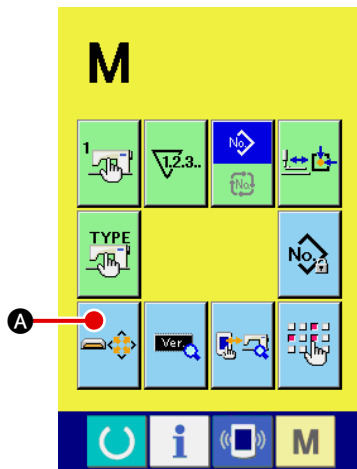

### ① Display the media format screen

When **M** switch is held pressed for three seconds, MEDIA FORMAT button  **A** is displayed on the screen. When this button is pressed, the media format screen is displayed.

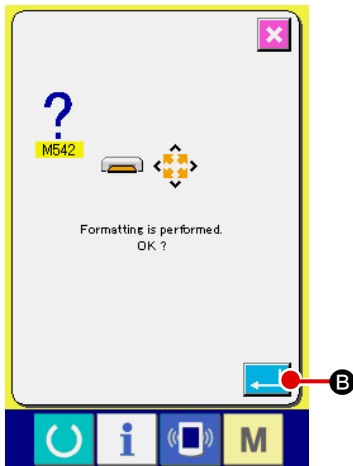

### ② Start formatting of the media

Set the media you desire to format to the media slot, close the cover, press ENTER button  **B** and formatting starts. Save necessary data in the media to the other media before formatting. When formatting is performed, the inside data are deleted.

When two or more media are connected to the sewing machine, the medium to be formatted is determined by the predetermined priority order.

High ← Low

CF(TM) slot ← USB device 1 ← USB device 2 ← ...  
When a CF (TM) is inserted in the CF (TM) slot, the CompactFlash (TM) will be formatted according to the priority order as shown above.

Refer to the USB specifications for the priority order of access.



## 2-33. Trial stitching function

Data created with PM-1 (sewing data programming/editing software) can be used for trial stitching by connecting the personal computer and the sewing machine online.

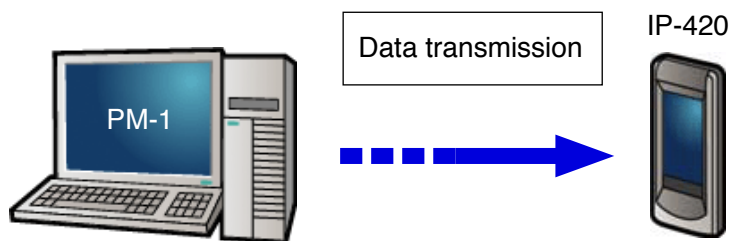

Connect the personal computer with the IP-420. Create data with the PM-1. Then, transmit the data to the sewing machine. When the IP-420 displays the data entry screen, the trial stitching screen is automatically displayed. Refer the HELP for the PM-1 for how to operate the PM-1.



**When programming a pattern, the starting point has to be set at coordinates (0, 0) or enter a second origin at coordinates (0, 0). Be aware that the garment-body presser and the wiper can interfere with each other depending on the location of the sewing starting position.**

### ● How to carry out trial stitching

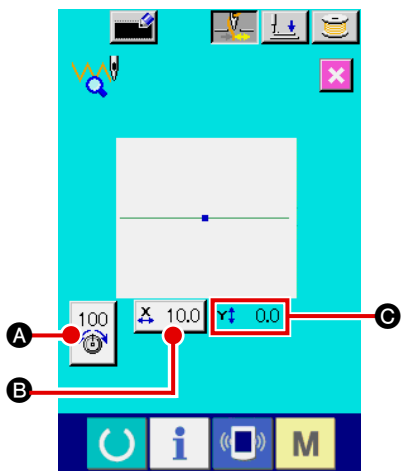

#### ① Receiving trial stitching data from the PM-1

When the data on trial stitching (vector form data) is sent from the PM-1, the trial stitching screen shown at left is displayed. At the center of the screen, the needle entry diagram of the transmitted data is displayed. The needle entry diagram differs in color according to the thread tension value.

#### ② Editing the vector data

Three items show described below can be set for the vector-form data transmitted from the PM-1.

- Ⓐ : Thread tension
- Ⓑ : X actual-dimension value
- Ⓒ : Y actual-dimension value

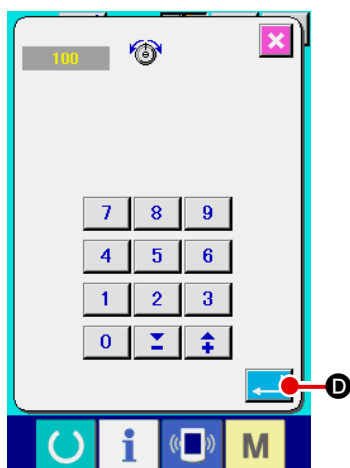

#### ③ Changing the data

When you press item (Ⓐ - Ⓒ) button you want to change, the numeric keys are displayed. Enter a desired value.

After the data entry, press enter button  Ⓓ.



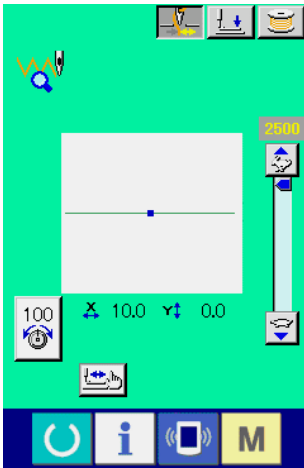

#### ④ Carrying out trial stitching

When you press set ready key  on the previous page, the trial stitching screen is displayed. In this state, you can carry out trial stitching.

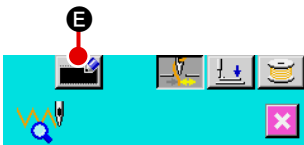

#### ⑤ Registering the data on a user pattern

If you want to register the data on trial stitching you have carried out, press register button  **E** displayed on the trial stitching screen. Enter the user pattern number under which you want to register the trial stitching data with numeric keys **F**.

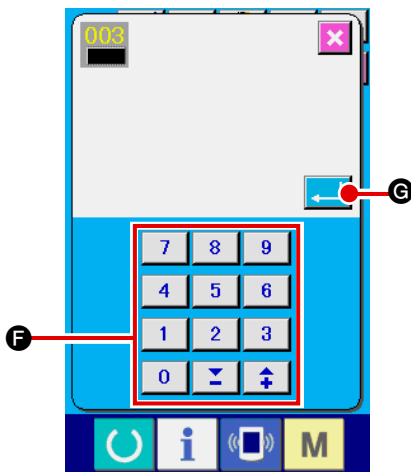

#### ⑥ Confirming the data registration

When you press enter button  **G**, the register screen is closed to finish registration.

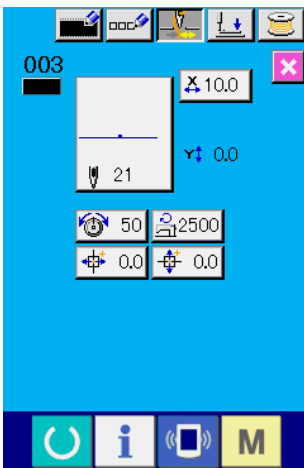

#### ⑦ Displaying the data entry screen

After registration, the data entry screen is automatically displayed.

## 2-34. How to use information

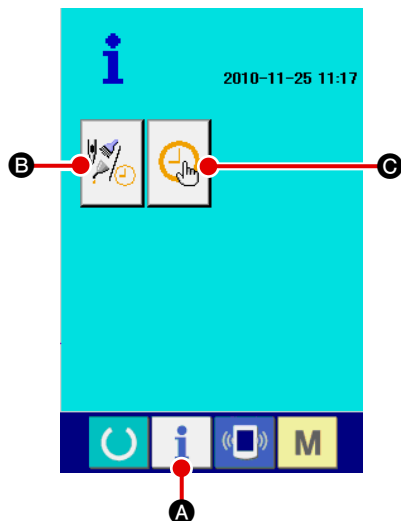

When you press information key **i** **A** on the switch sheet section of the data entry screen, the information screen is displayed.

### **B** Maintenance/inspection information

Time for changing oil (grease run-out), time for changing the needle and time for cleaning can be specified to output a warning notice when the specified time is reached.

→ Refer to "**II-2-34. (1) How to visually check maintenance/inspection information**", p.109.

→ Regarding the method to designate a time, refer to the Engineer's Manual.

### **C** Time setting

The current time can be set.

→ Refer to "**II-2-34. (3) How to carry out time setting**", p.111.

## (1) How to visually check maintenance/inspection information

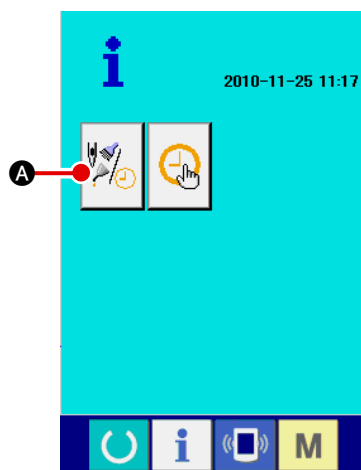

### ① Displaying the maintenance/inspection information screen

Press maintenance/inspection information button  **A** on the information screen.

Three information items are displayed on the maintenance/inspection information screen.

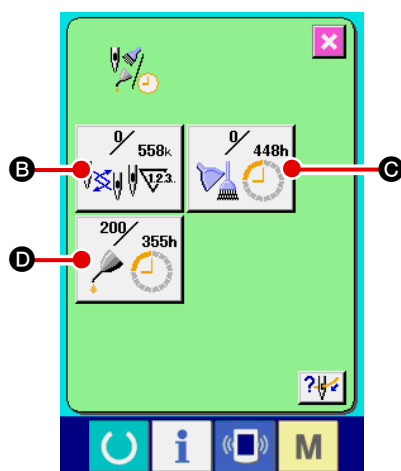

**B** : Needle changing  
(unit: 1,000 stitches)

**C** : Cleaning time (unit: hour)

**D** : Oil changing time (unit: hour)

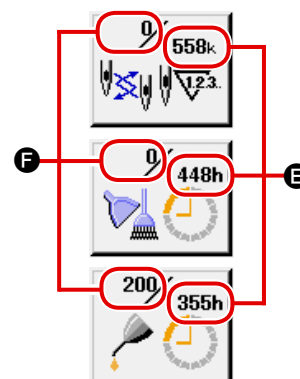

Items buttons **B**, **C** and **D** display inspection warning interval **E** and the remaining time before changing **F**.

In addition, the remaining time before changing can be cleared.

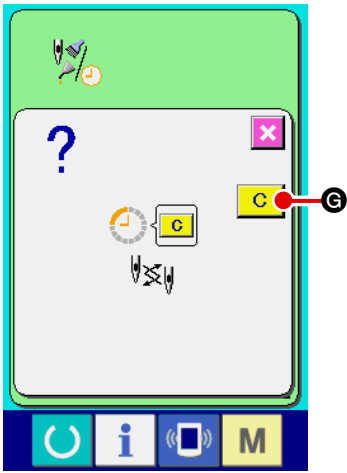

② **Clearing the remaining time before changing**

When you press item button **B**, **C** or **D** you want to clear, the changing time clear screen is displayed.

When you press clear button **C** **G**, the remaining time before changing is cleared.

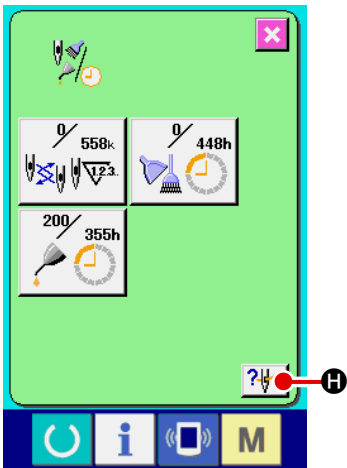

③ **Displaying the threading diagram**

When you press threading button  **H** displayed on the maintenance/inspection information screen, the machine-head threading diagram is displayed. Use this diagram when you thread the machine head.

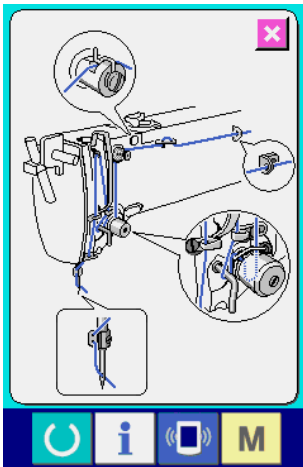

## (2) How to reset the warning

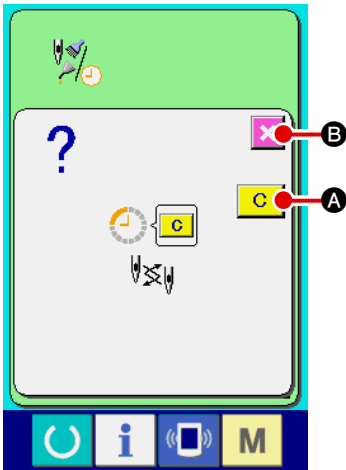

When the specified inspection time is reached, the warning screen is displayed.

To clear the inspection time, press clear button **C** **A**. The inspection time is cleared and the popup screen is closed.

If you do not clear the inspection time, press cancel button **X** **B** to close the popup screen. It should be noted, however, the warning screen will be displayed every time one sewing sequence is finished until the inspection time is cleared.

Warning number for each inspection item is as follows:

- Needle changing : A201
- Cleaning time : A202
- Time for changing oil : A203

## (3) How to set the time

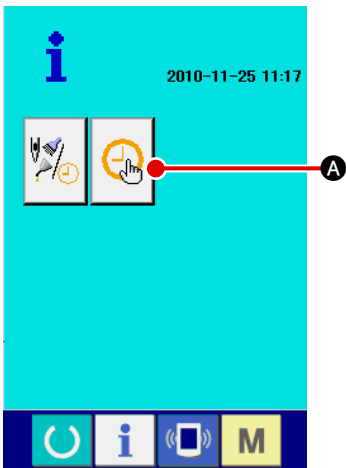

### ① Displaying the time setting screen

Press time setting button **A** on the information screen.

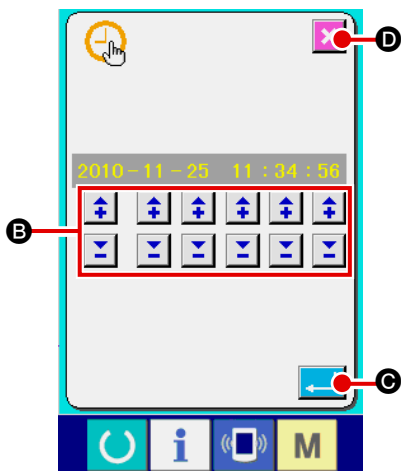

### ② Setting the current time of day

Press respective buttons **B** to set the time of day (year, month, day, hour: minute: second).

When you press enter button **C**, the set time is registered.

When you press cancel button **X** **D**, the set time becomes invalid and the screen returns to the information screen.

## 2-35. How to re-start sewing from the position where the machine has stopped by the detection of thread breakage

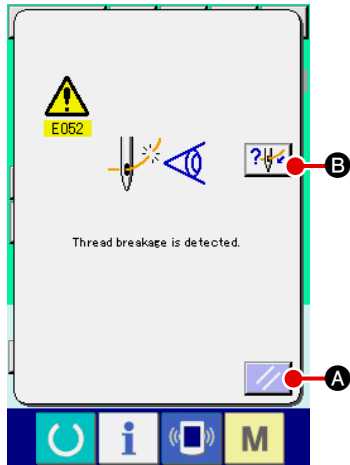



### ① Reset the error

Press reset button  **A** to reset the error.

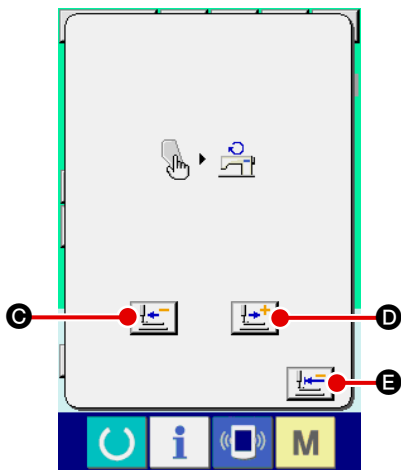
Press threading button  **B**, and the threading diagram will be displayed.



### ② Align the work clamp foot with the re-sewing position







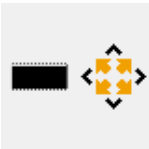
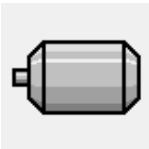

When you press feed backward button  **C**, the work clamp foot is moved backward in 1-stitch steps. When you press feed forward button  **D**, the work clamp foot is moved forward in 1-stitch steps. Move the work clamp foot to the re-sewing position.

### ③ Re-start sewing

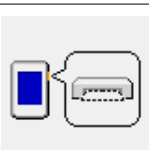







Press the start switch, and the sewing machine will re-start sewing.

If you do not want to carry out re-sewing, press initial position travel button  **E** to return the screen to the setting screen.

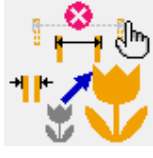

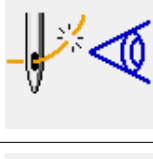

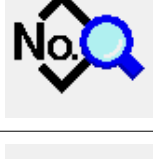



### 3. ERROR CODE LIST



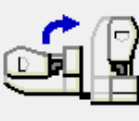
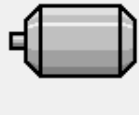
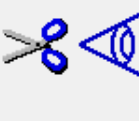

Error code	Display	Description of error	Display message	How to recover	Place of recovery
E001		<b>Main CPU EEPROM is initialized</b> Machine head and the control box differ in the type of model, or they have broken.	Data is initialized.	Turn OFF the power	
E007		<b>Machine lock</b> Main shaft of the sewing machine fails to rotate due to some trouble.	Machine is locked.	Turn OFF the power	
E008		<b>Undefined machine head is selected</b> Memory of machine head cannot be read.	Undefined head is selected.	Turn OFF the power	
E010		<b>Pattern No. error</b> Pattern No. which is backed up is not registered to data ROM, or setting of reading inoperative is performed.	Specified pattern does not exist.	Possible to re-enter after reset.	Previous screen
E011		<b>External media not inserted</b> External media is not inserted.	Media is not inserted.	Possible to re-enter after reset.	Previous screen
E012		<b>Read error</b> Data read from external media cannot be performed.	Data cannot be read.	Re-start after resetting is enabled.	Previous screen
E013		<b>Write error</b> Data write from external media cannot be performed.	Data cannot be written.	Re-start after resetting is enabled.	Previous screen
E014		<b>Write protect</b> The medium is in the write-protected state.	Writing is prohibited.	Re-start after resetting is enabled.	Previous screen
E015		<b>Format error</b> Format cannot be performed.	Formatting is impossible.	Re-start after resetting is enabled.	Previous screen
E016		<b>External media capacity over</b> Capacity of external media is insufficient.	Capacity is insufficient. (media)	Re-start after resetting is enabled.	Previous screen



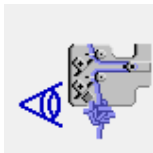
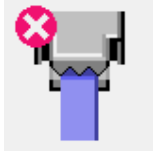

Error code	Display	Description of error	Display message	How to recover	Place of recovery
E017		<b>EEPROM capacity over</b> Machine memory capacity is insufficient.	Capacity is insufficient. (Machine)	Re-start after resetting is enabled.	Previous screen
E018		<b>EEPROM type error</b> The type of ROM is different from the correct one.	ROM type is different.	Re-start after resetting is enabled.	Previous screen
E019		<b>File size over</b> File is too large.	Pattern data is too large. (Approx. 20000 stitches)	Re-start after resetting is enabled.	Previous screen
E022		<b>File No. error</b> The specified file does not exist on the server or the medium.	Specified file does not exist.	Re-start after resetting is enabled.	Previous screen
E024		<b>Pattern data size over</b> Memory size is over.	Memory capacity has run out.	Re-start after resetting is enabled.	Data input screen
E027		<b>Server reading error</b> Data cannot be read from the server.	Data cannot be read.	Re-start after resetting is enabled.	Previous screen
E028		<b>Server writing error</b> Data write from server cannot be performed.	Data cannot be written.	Re-start after resetting is enabled.	Previous screen
E029		<b>Media lid open error</b> Lid of media slot is open.	Cover of media slot is open.	Re-start after resetting is enabled.	Previous screen
E030		<b>Needle bar position missing error</b> Needle bar is not in the predetermined position.	Needle is not in a proper position.	Re-start after resetting is enabled.	Data input screen
E031		<b>Air pressure drop</b> Air pressure is dropped.	Low air pressure.	Re-start after resetting is enabled.	Data input screen
E032		<b>File compatibility error</b> Incompatibility between files.	File cannot be read.	Re-start after resetting is enabled.	Data input screen



Error code	Display	Description of error	Display message	How to recover	Place of recovery
E040		<b>Moving limit is over</b> The sewing data exceeds the allowable sewing range.	Move limit is exceeded.	Re-start after resetting is enabled.	Setting screen
E042		<b>Operation error</b>	Operation cannot be performed.	Re-start after resetting is enabled.	Data input screen
E043		<b>Max. pitch over error</b> Max. pitch is exceeded.	Max Pitch is exceeded.	Re-start after resetting is enabled.	Data input screen
E045		<b>Pattern data error</b>	Pattern data no good.	Re-start after resetting is enabled.	Data input screen
E050		<b>Stop switch</b> When the stop switch is pressed.	Temporary stop switch is pressed.	Re-start after resetting is enabled.	Data input screen
E052		<b>Thread breakage detection error</b> When thread breakage is detected.	Thread breakage is detected.	Re-start after resetting is enabled.	Step input screen
E061		<b>Memory switch data error</b> Memory switch data is broken or revision is old.	Memory switch data error.	Turn OFF the power	
E062		<b>Pattern data error</b> In the case the memory switch data has corrupted or is of an earlier version.		Re-start after resetting is enabled.	Data input screen
E063		<b>Machine head identification error</b> The identified machine head does not match the control box. (The machine head and the EEPROM on the main PWB are different in model)		Turn OFF the power	
E064		<b>Read-only attribute</b> The destination file is placed in the read-only state by the read-only attribute.	Data cannot be written.	Re-start after resetting is enabled.	Data input screen

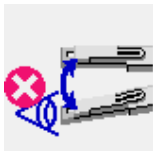
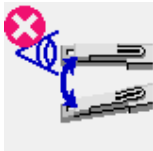



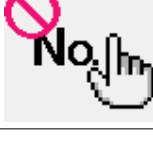
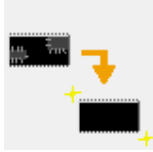



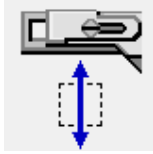



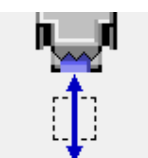
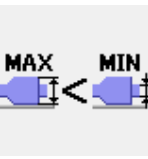



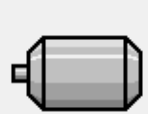

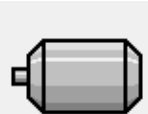
Error code	Display	Description of error	Display message	How to recover	Place of recovery
E220		<b>Grease run-out warning</b> Every time the number of stitches sewn has reached 100 million. → Refer to " <b>III-1-16. Replenishing the designated places with grease</b> ", p.138.	Important: Grease is running out. Add grease.	Re-start after resetting is enabled.	Data input screen
E221		<b>Grease run-out error</b> Every time the number of stitches sewn has reached 120 million, the sewing machine is placed in "sewing disabled" state. This error can be cleared with memory switch <b>U245</b> . → Refer to " <b>III-1-16. Replenishing the designated places with grease</b> ", p.138.	Important: Grease has run out. Add grease.	Re-start after resetting is enabled.	Data input screen
E290		<b>Belt loop grease up alarm</b> When the belt loop sewing has been performed for one million times. → Refer to " <b>III-1-16. Replenishing the designated places with grease</b> ", p.138.	Important: Belt-loop feeder is running out of grease. Add grease.	Re-start after resetting is enabled.	Data input screen
E291		<b>Belt loop grease up error</b> When the belt loop sewing has been performed for 1.2 million times, the machine will no longer be able to continue sewing. This situation can be reset by the memory switch <b>U269</b> . → Refer to " <b>III-1-16. Replenishing the designated places with grease</b> ", p.138.	Important: Belt-loop feeder has run out of grease. Add grease.	Re-start after resetting is enabled.	Data input screen
E302		<b>Machine head tilt check</b> When the machine head tilt sensor is in the OFF state.	Head is tilted.	Re-start after resetting is enabled.	Data input screen
E303		<b>Meniscus sensor error</b>	UP position of sewing machine motor cannot be detected. (Woodruff plate signal of sewing machine motor)	Turn OFF the power	
E305		<b>Thread trimming knife sensor error</b> The thread trimming knife is out of its normal position.	Thread trimmer knife sensor cannot be detected.	Turn OFF the power	
E306		<b>Thread grasping sensor error</b> The thread clamping device is out of its normal position.	Thread clamp sensor cannot be detected.	Turn OFF the power	
E363		<b>Sub-PWB error is detected (Power is turned OFF)</b>		Turn OFF the power	
E364		<b>Sub-PWB error is detected (Reset)</b>		Turn OFF the power	

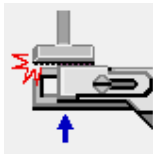

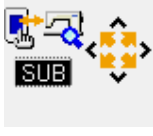

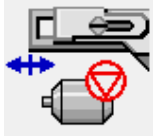
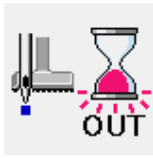

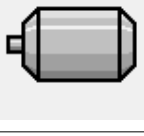
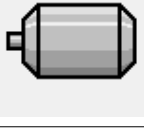

Error code	Display	Description of error	Display message	How to recover	Place of recovery
E368		<b>Belt-loop draw-out auxiliary device position sensor fault</b> The position sensor is not in its initial position on completion of the operation.	Sensor input is abnormal when auxiliary belt-loop draw-out device operates.	Re-start after resetting is enabled.	Data input screen
E369		<b>Belt-loop draw-out auxiliary device lock-up is detected</b> In the case the lock-up sensor stays ON for a predetermined time or the position sensor input remains unchanged at the time of driving. → In the case of a thick belt-loop, the lock-up sensor may detect lock-up state at the multi-layered part, resulting in this error. If this error occurs, change the lock-up detecting condition setting appropriately.	Auxiliary belt-loop draw-out device is locked.	Re-start after resetting is enabled.	Data input screen
E377		<b>Belt-loop grasping failure</b>	Failed to catch a belt loop.	Re-start after resetting is enabled.	Data input screen
E378		<b>Belt-loop drawing failure</b>	Failed to draw out a belt loop.	Re-start after resetting is enabled.	Data input screen
E379		<b>Multi-layered part ejection amount fault</b> When a multi-layered part of a belt-loop is ejected, the ejection amount is faulty (the end of the multi-layered part cannot be detected) → If this error occurs at any part other than the multi-layered part of a belt-loop, check whether the teaching value of the multi-layered part thickness is appropriate.	Feed out amount of multi-layered part of material is abnormal.	Re-start after resetting is enabled.	Data input screen
E380		<b>No belt-loop state is detected</b> No belt-loop insertion state is detected. → If this error occurs when a belt-loop has already been inserted correctly, check whether the teaching value of the multi-layered part thickness is appropriate.	No loop is present	Re-start after resetting is enabled.	Data input screen
E386		<b>Clamp upper-position sensor fault (upper position)</b> The upper position sensor is in the OFF state or the lower position sensor is in the ON state when the clamp rests at its upper position.	Input of sensor at the upper position of clamp is abnormal.	Re-start after resetting is enabled.	Data input screen



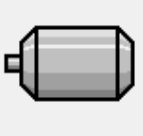
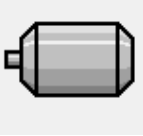
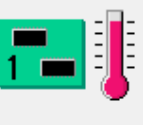

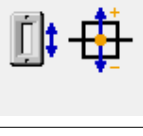
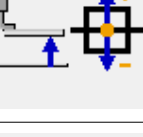
Error code	Display	Description of error	Display message	How to recover	Place of recovery
E387		<b>Clamp lower-position sensor fault (lower position)</b> The lower position sensor is in the OFF state or the upper position sensor is in the ON state when the clamp rests at its lower position. → This error also occurs in the case the clamp fails to come down to the sensor input position when a heavy-weight sewing material is used.	Input of sensor at the lower position of clamp is abnormal.	Re-start after resetting is enabled.	Data input screen
E388		<b>Clamp position sensor fault (upper and lower positions)</b> The clamp position sensor input is wrong at both the upper and lower positions.	Clamp upper/lower position sensor input is abnormal	Re-start after resetting is enabled.	Data input screen
E401		<b>Copy is disabled</b>	Cannot copy.	Possible to re-enter after reset.	Previous screen
E402		<b>Erase is disabled (in use for cycle operation)</b>	Data cannot be deleted since it is used for cycle data.	Possible to re-enter after reset.	Previous screen
E403		<b>Creation of new data is disabled</b>	This No. is already used.	Possible to re-enter after reset.	Previous screen
E404		<b>Pattern number selection is disabled</b>	This No. cannot be found.	Possible to re-enter after reset.	Previous screen
E435		<b>Out of input range error</b>	Set value exceeds data setting range.	Possible to re-enter after reset.	Previous screen
E476		<b>Sub-PWB backup data conversion</b>	Old backup data has been changed to new format	Turn OFF the power	
E477		<b>Belt-loop loosening motor out of range</b> This error code is displayed in the case the total of belt-loop dimensions B and D exceeds 66.0 mm for shape Nos. 4 and 5, in the case the total of belt-loop dimension B and a half of the loosening amount exceeds 66.0 mm for shape Nos. 7 and 12, or in the case the total of belt-loop dimension B and the loosening amount exceeds 66.0 mm for shape Nos. 9 and 11. Respectively set the aforementioned dimensions so that the total value does not exceed 66.0 mm.	Travel destination of loop loosening motor is out of setting range.	Re-start after resetting is enabled.	Previous screen

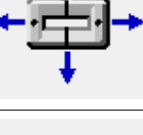
Error code	Display	Description of error	Display message	How to recover	Place of recovery
E478		<b>Belt-loop shape does not match garment-body presser shape</b> In the case "Additional clamp is provided" is selected, sewing is prohibited if the sewing shape No. 2 or 6 is selected.	Garment-body presser shape does not match belt loop shape	Re-start after resetting is enabled.	Previous screen
E479		<b>Pattern No. cannot be deleted (pattern No. individual key-lock is set)</b> In the case deletion of the pattern No. for which the pattern No. individual key-lock is set is attempted.	Not erasable since keys are under key lock state	Re-start after resetting is enabled.	Previous screen
E480		<b>Bartacking data fault</b> In the case the bartacking pattern which is selected as the belt-loop pattern has not yet registered.	Unregistered bartacking is selected.	Re-start after resetting is enabled.	Previous screen
E481		<b>Work clamp foot/bartacking shape unmatched</b> In the case the zigzag bartacking is included in the pattern to be sewn with the work clamp foot for linear bartacking.	Feeding frame shape does not match bartacking shape.	Re-start after resetting is enabled.	Data input screen
E482		<b>Feeder position pattern data fault</b> → If this error is detected, re- turn the power ON. Then the parameter which was the cause of the error is cleared to return to the initial value.	Pattern data value of belt loop feeder is abnormal.	Turn OFF the power	
E484		<b>Data cannot be erased (user pattern)</b> In the case deletion of the user pattern which has been registered to the belt-loop pattern is attempted.	Data cannot be erased because it is used for a belt loop pattern.	Re-start after resetting is enabled.	Previous screen
E485		<b>Feeder X-axis motor travel range fault</b>	Travel destination of feeder X-axis motor is out of setting range.	Turn OFF the power	
E486		<b>Feeder Y-axis motor travel range fault</b>	Travel destination of feeder Y-axis motor is out of setting range.	Turn OFF the power	





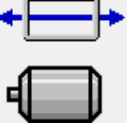
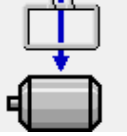
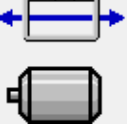
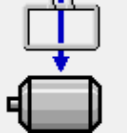

Error code	Display	Description of error	Display message	How to recover	Place of recovery
E487		<b>Garment-body moving motor travel-range fault</b>	Travel destination of garment body moving motor is out of setting range.	Turn OFF the power	
E488		<b>Loop loosening motor travel-range fault</b>	Travel destination of loop loosening motor is out of setting range.	Turn OFF the power	
E489		<b>Belt-loop feeding motor travel-range fault</b>	Travel destination of draw-out motor is out of setting range.	Turn OFF the power	
E490		<b>Belt-loop thickness teaching set-value range fault</b> In the case, on the belt-loop teaching screen, the difference-in-height detecting position is set to a larger value than the belt-loop no-insertion detecting position value or the enter button is pressed with both values set to an equal value.	Belt loop thickness setting is abnormal.	Re-start after resetting is enabled.	Previous screen
E702		<b>CPU runaway is detected</b>	Program is abnormal. (CPU)	Turn OFF the power	
E703		<b>Machine type error (Panel is connected to the sewing machine which is not supposed.)</b> When the machine type code of system is not proper in the initial communication.	Model of sewing machine is different from that of panel.	Possible to rewrite program after pressing down communication switch.	Communication screen
E704		<b>Inconsistency of system version</b> System software version is inconsistent in the initial communication.	Version of program incompatible.	Possible to rewrite program after pressing down communication switch.	Communication screen
E730		<b>Main shaft motor encoder is defective or lacking for phases</b> When encoder of the sewing machine motor is abnormal.	Sewing machine motor is defective. (Encoder A and B phases)	Turn OFF the power	
E731		<b>Main motor hole sensor is defective or position sensor is defective</b> Hole sensor or position sensor of the sewing machine motor is defective.	Sewing machine motor is defective. (Encoder U V and W phases)	Turn OFF the power	
E733		<b>Reverse rotation of main shaft motor</b> When the sewing machine motor rotates in the reverse direction.	Sewing machine motor runs in the reverse direction.	Turn OFF the power	



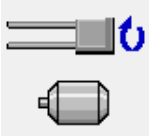
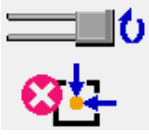

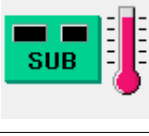
Error code	Display	Description of error	Display message	How to recover	Place of recovery
E762		<b>LK work clamp foot interferes with the clamp</b> In the case the clamp hits against the work clamp foot of the LK machine when the former passes under the latter.	Work clamp foot and clamp of LK interfere each other.	Turn OFF the power	
E763		<b>Sub-PWB CPU fault</b>	Sub-PWB CPU is abnormal.	Turn OFF the power	
E764		<b>Sub-PWB backup data is initialized</b>	Data has been initialized. (Sub-PWB backup data)	Turn OFF the power	
E765		<b>Sub-PWB correction-value backup data is initialized</b>	Data has been initialized. (Sub-PWB correction backup data)	Turn OFF the power	
E786		<b>Preset device status fault</b>	Response from preset device has not been received.	Turn OFF the power	
E787		<b>Feeder X-axis motor stop position fault</b> In the case the incorrect stop position of the belt-loop feeder in X-axis direction is detected.	Feeder X-axis stop position is not correct.	Turn OFF the power	
E788		<b>Predetermined wait time for LK to start sewing has run out</b>	Change in S.STATE signal cannot be detected.	Turn OFF the power	
E789		<b>Predetermined wait time for LK to lift the work clamp foot has run out</b>	Change in LK work clamp foot position signal cannot be detected.	Turn OFF the power	
E802		<b>Power electrical discontinuity detection</b>	Power instantaneously lost.	Turn OFF the power	
E811		<b>Over voltage</b> When input power is more than the specified value.	Input voltage is too high. (Check input voltage.)	Turn OFF the power	
E813		<b>Low voltage</b> When input power is less than the specified value.	Input voltage is too low. (Check input voltage.)	Turn OFF the power	

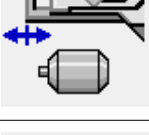
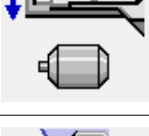
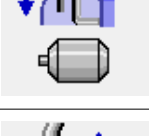
Error code	Display	Description of error	Display message	How to recover	Place of recovery
E901		<b>Main shaft motor IPM abnormality</b> When IPM of servo control p.c.b. is abnormal.	SDC P.C.B. is defective. (IPM)	Turn OFF the power	
E902		<b>Main shaft motor over current</b>		Turn OFF the power	
E903		<b>Stepping motor power abnormality</b> When stepping motor power of SERVO CONTROL p.c.b. fluctuates more than $\pm 15\%$ .	Power of SDC P.C.B. is defective. (Stepping motor power 85 V)	Turn OFF the power	
E904		<b>Solenoid power abnormality</b> When solenoid power of SERVO CONTROL p.c.b. fluctuates more than $\pm 15\%$ .	Power of SDC P.C.B. is defective. (Solenoid power 33 V)	Turn OFF the power	
E905		<b>Main-shaft heat sink temperature fault</b> Overheat of servo control p.c.b. Turn ON the power again after taking time.	Temperature of SDC P.C.B. is too high.	Turn OFF the power	
E907		<b>X feed motor origin retrieval error</b> When origin sensor signal is not inputted at the time of origin retrieval motion.	Origin of X motor cannot be found. (X origin sensor)	Turn OFF the power	
E908		<b>Y feed motor origin retrieval error</b> When origin sensor signal is not inputted at the time of origin retrieval motion.	Origin of Y motor cannot be found. (Y origin sensor)	Turn OFF the power	
E910		<b>Presser motor origin retrieval error</b> When origin sensor signal is not inputted at the time of origin retrieval motion.	Origin of presser thread trimmer motor cannot be found. (Presser thread trimmer origin sensor)	Turn OFF the power	
E913		<b>Thread clamp origin retrieval error</b> When origin sensor signal is not inputted at the time of origin retrieval motion.	Origin of thread clamp motor cannot be found. (Thread clamp origin sensor)	Turn OFF the power	
E914		<b>X, Y Feed defective error</b> Timing lag between feed and main shaft occurs	X/Y feed trouble is detected.	Turn OFF the power	
E915		<b>Communication abnormality between operation panel and MAIN CPU</b> When abnormality occurs in data communication.	Communication is impossible. (Panel - MAIN P.C.B.)	Turn OFF the power	











Error code	Display	Description of error	Display message	How to recover	Place of recovery
E916		<b>Communication abnormality between MAIN CPU and main shaft CPU</b> When abnormality occurs in data communication.	Communication is impossible. (MAIN P.C.B. - SDC P.C.B.)	Turn OFF the power	
E917		<b>Communication failure between operation panel and personal computer</b> When abnormality occurs in data communication.	Communication is impossible. (Panel - PC)	Turn OFF the power	
E918		<b>Main p.c.b. heat sink temperature fault</b> Overheat of MAIN p.c.b. Turn ON the power again after taking time.	Main P.C.B. temperature is too high.	Turn OFF the power	
E926		<b>X-motor excessive location deviation error</b>	X-feed motor position is off.	Turn OFF the power	
E927		<b>Y-motor excessive location deviation error</b>	Y-feed motor position is off.	Turn OFF the power	
E931		<b>X-motor overload error</b>	X-feed motor overload is excessive.	Turn OFF the power	
E932		<b>Y-motor overload error</b>	Y-feed motor overload is excessive.	Turn OFF the power	
E943		<b>EEPROM of main CPU is defective</b> When data writing to MAIN CONTROL p.c.b. cannot be performed.	MAIN P.C.B. is defective.	Turn OFF the power	

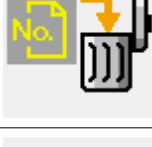





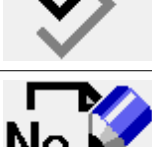



Error code	Display	Description of error	Display message	How to recover	Place of recovery
E946		<b>Machine head EEPROM write failure</b> When data writing to machine head p.c.b. cannot be performed.	Head P.C.B. is defective.	Turn OFF the power	
E975		<b>Fork rotating motor step-out detection</b>	Out-of-step of fork rotating motor has been detected.	Re-start after resetting is enabled.	Data input screen
E976		<b>Fork rotating motor origin-retrieval error</b> In the case the origin sensor signal is not input when the origin retrieval operation is carried out.	Origin of fork rotating motor could not be found.	Turn OFF the power	
E977		<b>Operation panel ⇄ Sub-PWB CPU communication disabled</b> In the case data communication fault has occurred.	Communication cannot be carried out. (Operation panel – Sub-PWB)	Turn OFF the power	
E978		<b>Sub-PWB temperature fault</b> <b>Sub-PWB overheats</b> Re-turn the power ON after the lapse of a certain period of time.	Sub-PWB temperature is rising.	Turn OFF the power	
E979		<b>Feeder unit ⇄ Main control CPU communication disabled</b> In the case data communication fault has occurred.	Communication cannot be carried out. (Feeder – Main PWB)	Turn OFF the power	
E980		<b>Feeder X-axis motor step-out detection</b>	Out-of-step of feeder X-axis motor has been detected.	Turn OFF the power	
E981		<b>Feeder Y-axis motor step-out detection</b>	Out-of-step of feeder Y-axis motor has been detected.	Turn OFF the power	
E982		<b>Garment-body moving motor step-out detection</b>	Out-of-step of garment body moving motor has been detected.	Turn OFF the power	
E983		<b>Belt-loop loosening motor step-out detection</b>	Out-of-step of loop loosening motor has been detected.	Turn OFF the power	
E984		<b>Belt-loop feeding motor step-out detection</b>	Out-of-step of draw-out motor has been detected.	Turn OFF the power	



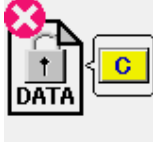
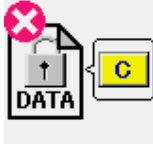

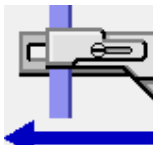
Error code	Display	Description of error	Display message	How to recover	Place of recovery
E985		<b>Feeder X-axis motor origin-retrieval error</b> In the case the origin sensor signal is not input when the origin retrieval operation is carried out.	Origin of feeder X-axis motor could not be found.	Turn OFF the power	
E986		<b>Feeder Y-axis motor origin-retrieval error</b> In the case the origin sensor signal is not input when the origin retrieval operation is carried out.	Origin of feeder Y-axis motor could not be found.	Turn OFF the power	
E987		<b>Garment-body moving motor origin-retrieval error</b> In the case the origin sensor signal is not input when the origin retrieval operation is carried out.	Origin of garment body moving motor could not be found.	Turn OFF the power	
E988		<b>Belt-loop loosening motor origin-retrieval error</b> In the case the origin sensor signal is not input when the origin retrieval operation is carried out.	Origin of loop loosening motor could not be found.	Turn OFF the power	
E989		<b>Belt-loop feeding motor origin-retrieval error</b> In the case the origin sensor signal is not input when the origin retrieval operation is carried out.	Origin of draw-out motor could not be found.	Turn OFF the power	

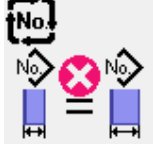
## 4. Message list

Message No.	Display	Displayed message	Description
M520		Erasing is performed. OK ?	<b>Confirmation of user pattern erasure</b> Erases the user pattern Yes or No?
M522		Erasing is performed. OK ?	<b>Confirmation of cycle pattern</b> Erases the user pattern Yes or No?
M524		Erasing is performed. OK ?	<b>Confirmation of erasure on communication screen (pattern data)</b> Erases the user pattern Yes or No?
M525		Erasing is performed. OK ?	<b>Confirmation of erasure on communication screen (sewing machine data)</b> Erases the user pattern Yes or No?
M526		Erasing is performed. OK ?	<b>Confirmation of erasure on communication screen (program data)</b> Erases the user pattern Yes or No?
M528		Overwriting is performed. OK ?	<b>Confirmation of user pattern overwrite</b> Overwrites user pattern Yes or No?
M529		Overwriting is performed. OK ?	<b>Confirmation of media data overwrite</b> Overwrites user pattern Yes or No?
M530		Overwriting is performed. OK ?	<b>Confirmation of overwrite on communication screen (operation panel + pattern data)</b> Overwrites user pattern Yes or No?
M531		Overwriting is performed. OK ?	<b>Confirmation of overwrite on communication screen (media + pattern data)</b> Overwrites user pattern Yes or No?
M532		Overwriting is performed. OK ?	<b>Confirmation of overwrite on communication screen (server + pattern data)</b> Overwrites user pattern Yes or No?
M533		Overwriting is performed. OK ?	<b>Confirmation of overwrite on communication panel screen (operation panel + sewing machine data)</b> Overwrites user pattern Yes or No?

Message No.	Display	Displayed message	Description
M534		Overwriting is performed. OK ?	<b>Confirmation of overwrite on communication screen (media + pattern data)</b> Overwrites user pattern Yes or No?
M535		Overwriting is performed. OK ?	<b>Confirmation of overwrite on communication screen (server + pattern data)</b> Overwrites user pattern Yes or No?
M537		Deleting is performed. OK ?	<b>Confirmation of tension data deletion (thread tension)</b> Deletes thread-tension data Yes or No?
M539		Deleting is performed. OK ?	<b>Confirmation of cycle sewing data deletion</b> Deletes thread-tension data Yes or No?
M541		All data in cycle data are deleted. OK ?	<b>Confirmation of all cycle data deletion</b> Deletes all pieces of data contained in cycle data Yes or No?
M542		Formatting is performed. OK ?	<b>Confirmation of formatting</b> Formats the data storage medium Yes or No?
M544		Data does not exist.	<b>Communication screen input No. disabled (operation panel)</b> No data exists.
M545		Data does not exist.	<b>Communication screen input No. disabled (media)</b> No data exists.
M546		Data does not exist.	<b>Communication screen input No. disabled (server)</b> No data exists.
M547		Overwriting cannot be performed since data exists.	<b>Communication screen overwrite disabled (operation panel)</b> Overwrite is disabled since data exists.
M548		Overwriting cannot be performed since data exists.	<b>Communication screen overwrite disabled (media)</b> Overwrite is disabled since data exists.

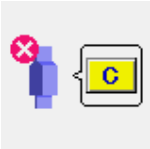
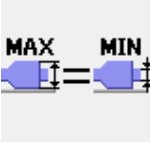
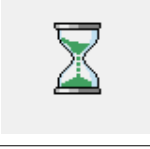
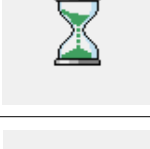
Message No.	Display	Displayed message	Description
M549		Overwriting cannot be performed since data exists.	<b>Communication screen overwrite disabled (server)</b> Overwrite is disabled since data exists.
M554		Key-lock customization data have been initialized.	<b>Customized data initialization notification</b> Key-lock customized data has been initialized.
M555		Key-lock customization data are broken. Initializing is OK?	<b>Customized data breakage notification</b> Key-lock customized data has broken. Do you want to initialize it?
M556		Key-lock customization data are to be initialized. OK?	<b>Confirmation of customized data initialization</b> Initializes key-lock customized data Yes or No?
M589		Belt loop pattern data content of registration source is to be changed OK?	<b>Confirmation of the change made to the belt-loop pattern data under the cycle sewing mode</b> Registered original belt-loop pattern data content will be changed. Do you want to change the data content? Yes or No?
M590		Re-press on the button makes belt loop clamp move forward.	<b>Confirmation of the belt-loop clamp operation</b> Press this key again to move the belt-loop clamp forward.
M591		Pressing ENTER key makes device move.	<b>Check program (adjustment mode)</b> Device operation confirmation at the time screen transition. Press the enter key to move the device.
M592		When another belt loop is sewn, sewing counter reaches preset number before finishing sewing.	<b>Upon sewing screen transition/upon completion of sewing</b> When the next belt-loop is sewn, the sewing counter increments one count.
M594		Belt-loop pattern width does not agree with the value registered in cycle pattern	<b>Belt-loop width for cycle sewing pattern</b> The belt-loop pattern width registered in the cycle pattern does not match the actual belt-loop width.
M596		The garment-body presser may interfere with loop clamp. OK?	<b>Garment-body presser/belt-loop clamp interference</b> In the case the belt-loop width is set at a small value and the bartacking width is set to a large value, the garment-body presser and the clamp can interfere with each other.

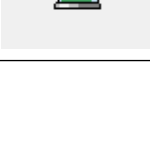
Message No.	Display	Displayed message	Description
M598		X motor range is out of setting range	<b>Feeder unit X-axis motor is out of range</b> The X-axis motor travel range is out of the allowable range. The allowable range within which the X-axis motor can move forward during sewing of a belt-loop is exceeded because of the X-axis motor position correction setting.
M599		Y motor range is out of setting range	<b>Feeder unit Y-axis motor is out of range</b> The Y-axis motor travel range is out of the allowable range. The allowable range within which the Y-axis motor can move forward during grasping of a belt-loop is exceeded because the belt-loop length is too short.
M600		Data on multi-layered parts is cleared. OK?	<b>Clearing of information on multi-layered-part</b> Clears the information on the multi-layered part Yes or No?
M601		No difference between the measured maximum and minimum thicknesses of belt loop. Multi-layered part may not have been measured. Data is entered. OK?	<b>Belt-loop teaching</b> Only a small difference exists between the maximum and minimum values of the measured belt-loop thickness. Multi-layered part thickness may not have been measured. Do you want to confirm data?
M653		Formatting is performed.	<b>Formatting</b> Formatting is being carried out.
M669		Data is being read.	<b>Reading data</b> Data is being read.
M670		Data is being written.	<b>Writing data</b> Data is being written.
M671		Data is being converted.	<b>Converting data</b> Data is being converted.

## III. Maintenance

### 1. Maintenance

#### 1-1. Discharging drainage water



**CAUTION :**

Do not place hands, feet, face or tools on the moving part of the main body so as to protect against possible accidents caused by abrupt start of the machine.

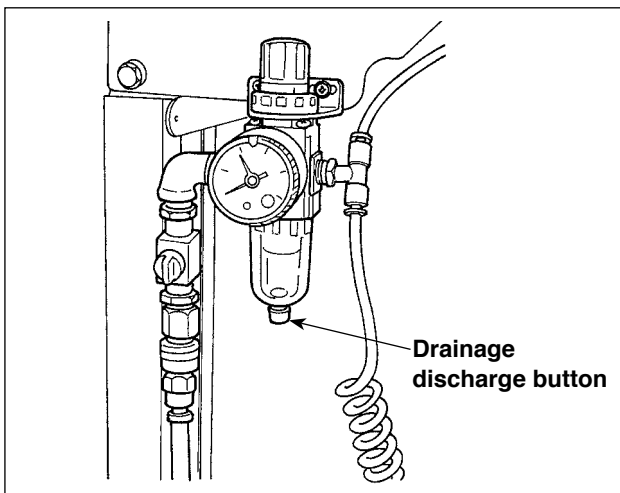

Be sure to discharge drainage water from the filter.

Press the drainage discharge button on the underside of the filter to discharge water accumulated in the filter.

Loosen the screw of the drainage discharge button on the underside of the filter to discharge water accumulated in the filter.

After having drained the filter, firmly tighten the screw of the drainage discharge button.

#### 1-2. Adjusting the height of the needle bar



**CAUTION :**

Turn OFF the power before starting the work so as to prevent accidents caused by abrupt start of the sewing machine.

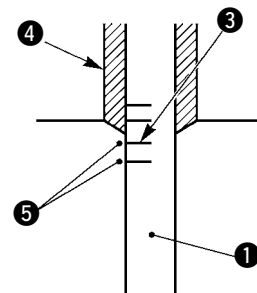
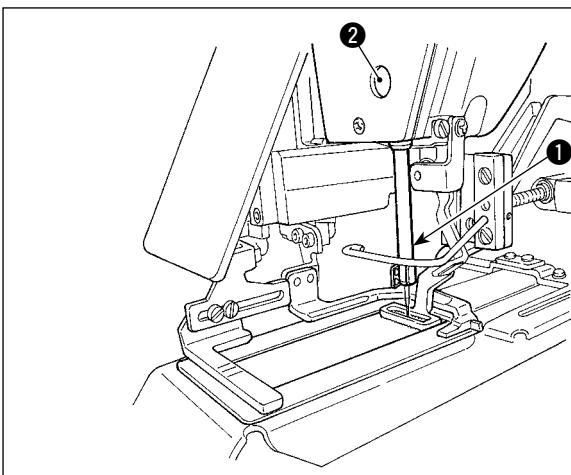

⑤ : Engraved line for DP x 17

Bring needle bar ① to the lowest position of its stroke. Loosen needle bar connection screw ② and adjust so that upper marker line ③ engraved on the needle bar aligns with the bottom end of needle bar bushing, lower ④.



After the adjustment, make sure that there is no uneven torque.

\* When stitch skipping occurs in accordance with the sewing conditions, adjust the height of the needle bar so as to lower it by 0.5 to 1 mm from the needle bar engraved line ③.

### 1-3. Adjusting the needle-to-shuttle relation



**CAUTION :**  
Turn OFF the power before starting the work so as to prevent accidents caused by abrupt start of the sewing machine.

#### Relation between needle and engraved lines

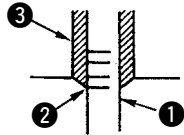

- 1) Turn the handwheel by hand. When needle bar ① has gone up, adjust so that lower marker line ② engraved on the needle bar aligns with the bottom end of the needle bar bushing, lower ③.

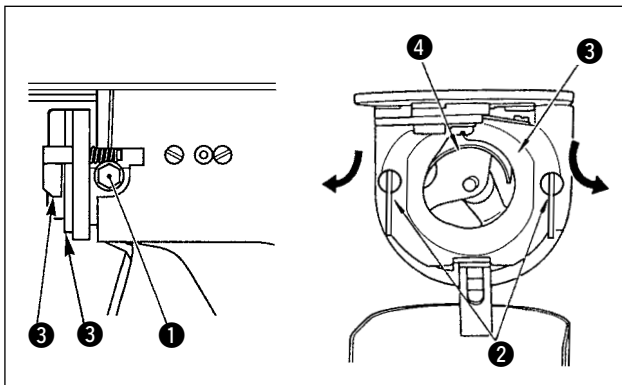

- 2) Loosen setscrew ① in the driver. Open inner hook pressers ② to the right and left, and remove inner hook presser ③.



**At this time, be careful not to let inner hook ④ come off and fall.**

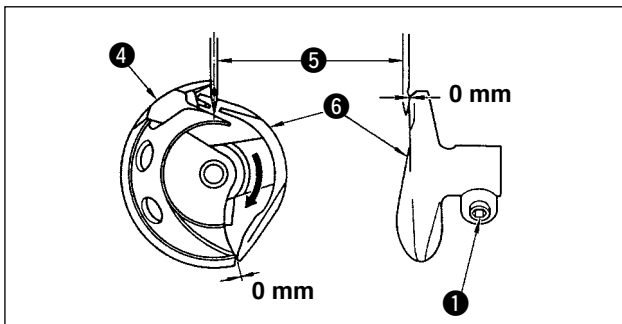

- 3) Adjust so that the blade point of inner hook ④ aligns with the center of needle ⑤, and that a clearance of 0 mm is provided between the front end of the driver and the needle as the front end face of driver ⑥ receives the needle to prevent the needle from being bent. Then tighten setscrew ① of the driver.

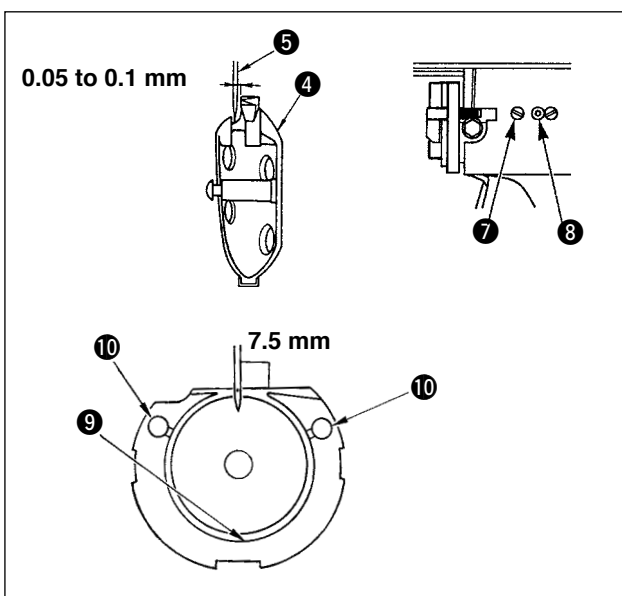

- 4) Loosen setscrew ⑦ of the shuttle, and adjust the longitudinal position of the shuttle. To do this adjustment, turn shuttle race adjusting shaft ⑧ clockwise or counterclockwise to provide a 0.05 to 0.1 mm clearance between needle ⑤ and the blade point of inner hook ④.
- 5) After adjusting the longitudinal position of the shuttle, further adjust to provide a 7.5 mm clearance between the needle and the shuttle by adjusting the rotating direction. Then tighten setscrew ⑦ of the shuttle.



**Apply a small amount of oil to race section ⑨ and oil wick ⑩, and use the sewing machine after an extended period of disuse or cleaning the periphery of hook portion.**



## 1-4. Adjusting the lift of the work clamp foot



### CAUTION :

As the work is performed while the power is ON, never touch the switches other than the necessary one so as to prevent accidents caused by the malfunction of switches.

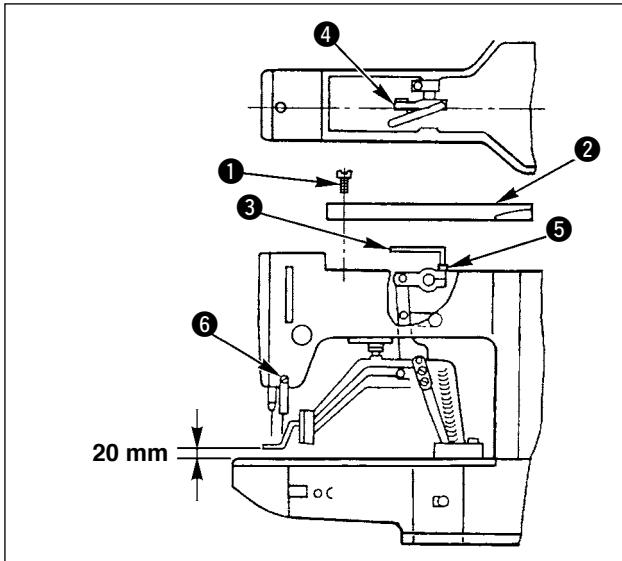

- 1) With the machine in stop mode, remove six setscrews ① of the top cover, and take off top cover ②.
- 2) Apply L-shaped wrench ③ to socket bolt ⑤ of clamp ④, and loosen the socket bolt.
- 3) Push down L-shaped wrench ③ to increase the lift of the work clamp foot, or pull it up to decrease the lift.
- 4) After the adjustment, securely tighten socket bolt ⑤.



If the work clamp foot lever support plate interferes with the wiper, readjust the height of the wiper using setscrew ⑥ in the wiper installing base.

## 1-5. The moving knife and counter knife



### CAUTION :

Turn OFF the power before starting the work so as to prevent accidents caused by abrupt start of the sewing machine.

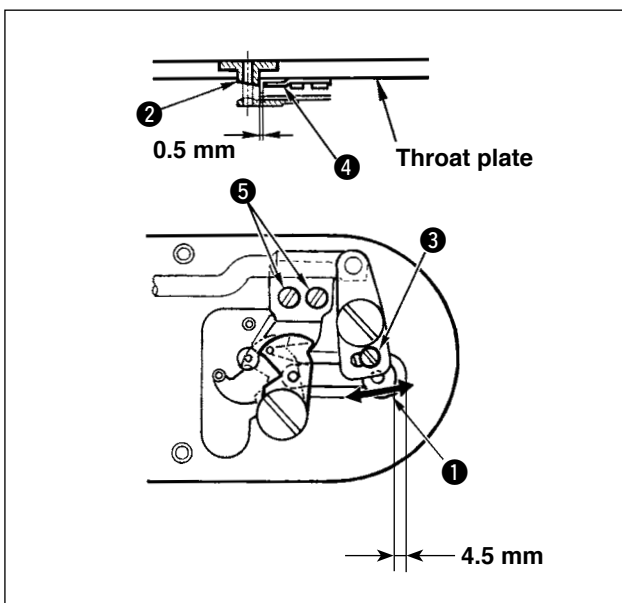

- 1) Loosen adjusting screw ③ so that a clearance of 4.5 mm is provided between the front end of the throat plate and the top end of thread trimmer lever, small ①. To adjust, move the moving knife in the direction of arrow.
- 2) Loosen setscrew ⑤ so that a clearance of 0.5 mm is provided between needle hole guide ② and counter knife ④. To adjust, move the counter knife.

## 1-6. Needle thread clamp device



### CAUTION :

Turn OFF the power before starting the work so as to prevent accidents caused by abrupt start of the sewing machine.

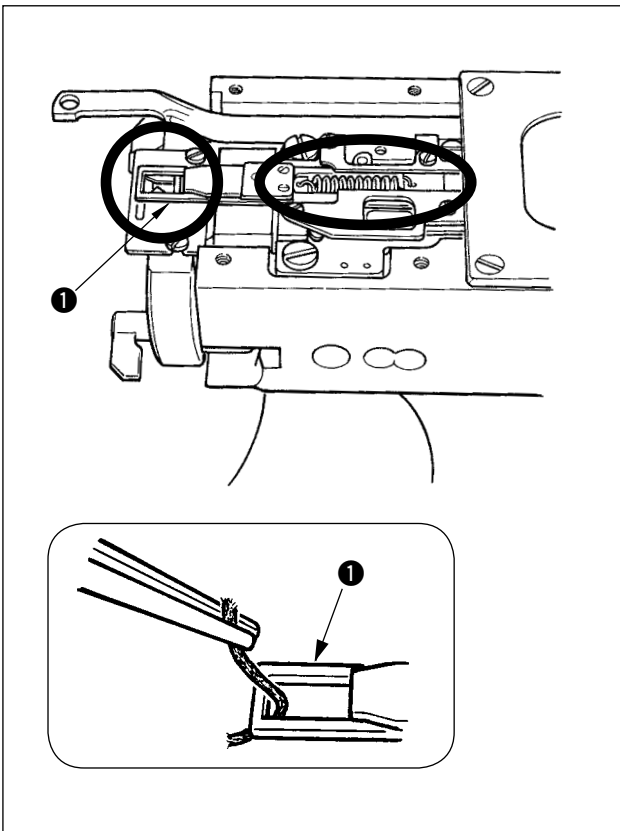

- 1) When thread is caught at top end ❶ of the thread clamp, thread clamp becomes incomplete and sewing trouble at the sewing start will be caused.  
Remove it with tweezers or the like.
- 2) When removing thread waste or thread dust collected on the thread clamp device, remove it after removing the throat plate.

## 1-7. Adjustment of the wiper



### CAUTION :

Turn OFF the power before starting the work so as to prevent accidents caused by abrupt start of the sewing machine.

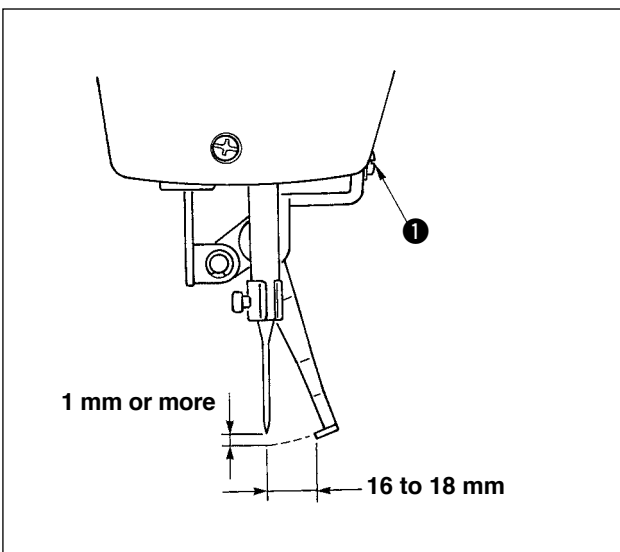

- 1) Loosen screw ❶ to adjust so that a clearance of 1 mm or more is provided between the wiper and the needle.  
At this time, the standard of the distance between the wiper and the needle is 16 to 18 mm. By adjusting the distance wide, the work clamp foot can prevent stepping on needle thread when it comes down.
- \* The position of the needle is when the sewing machine has stopped after the sewing finished.

### 1-8. Thread breakage detector plate

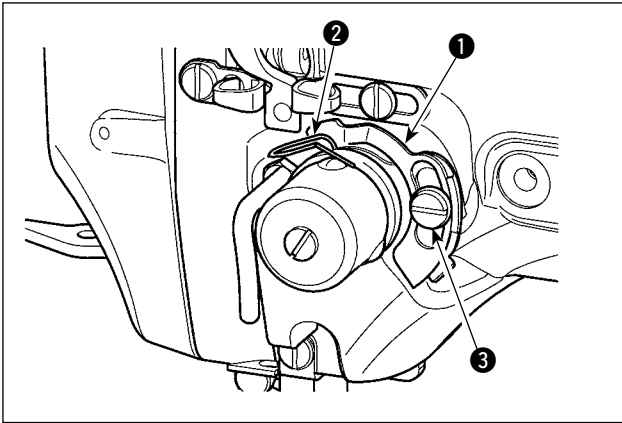

- 1) Adjust so that thread breakage detector plate **1** is always in contact with thread take-up spring **2** in the absence of needle thread. (Slack: approx. 0.5mm)
- 2) Whenever the stroke of thread take-up spring **2** has been changed, be sure to readjust thread breakage detector plate **1**. To make this adjustment, loosen screw **3**.



Adjust so that thread breakage detector plate **1** does not touch any adjacent metallic parts other than thread take-up spring **2**.

### 1-9. Draining waste oil

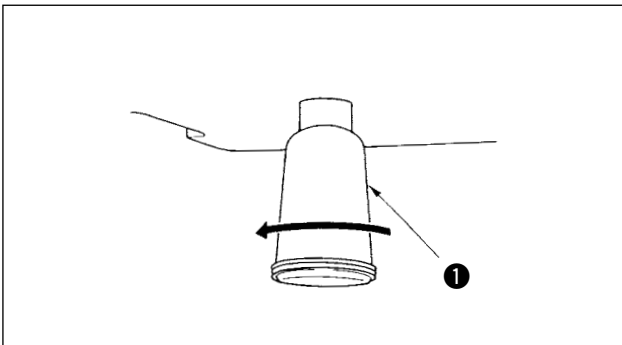

When polyethylene oiler **1** becomes filled with oil, remove polyethylene oiler **1** and drain the oil.

### 1-10. Amount of oil supplied to the hook

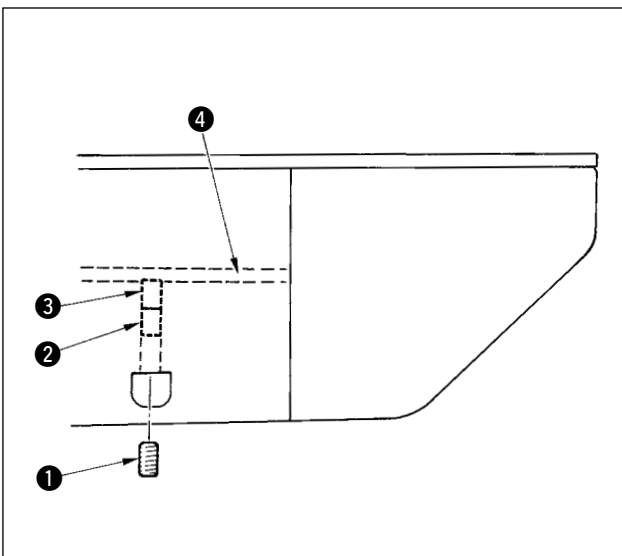

- 1) Loosen setscrew **1** and remove setscrew **1**.
- 2) When screwing in adjustment screw **2**, the amount of oil of oil pipe, left **4** can be reduced.
- 3) After the adjustment, screw in setscrew **1** and fix it.



1. The state of standard delivery is the position where **3** is lightly screwed in and returned by 4 turns.

2. When reducing the amount of oil, do not screw in the screw at once. Observe the state for approximately half a day at the position where **3** is screwed in and returned by 2 turns. If reducing is excessive, worn-out of the hook will result.

### 1-11. Replacing the work clamp foot of the sewing machine

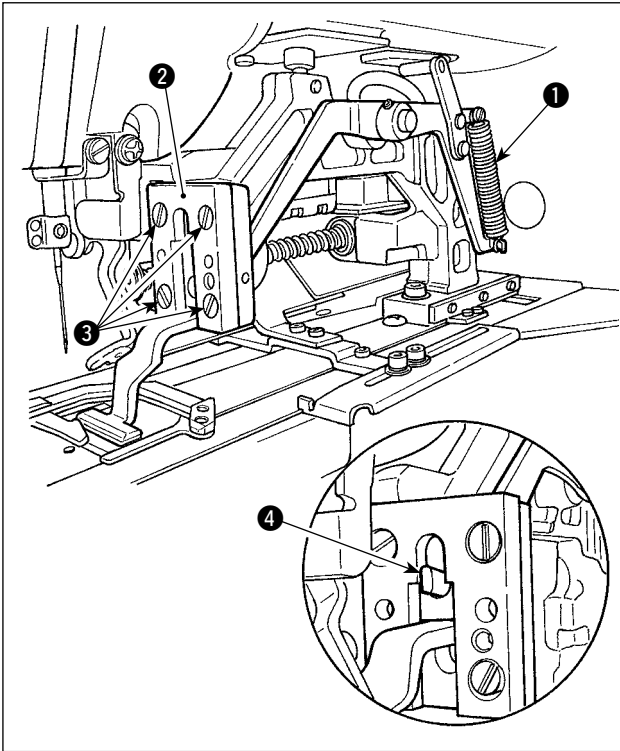

Remove spring ① which presses down the work clamp foot. Loosen setscrews ③ which secures work clamp foot guide ② to replace the work clamp foot of the sewing machine.

When placing the replacement work clamp foot, check to be sure that top end ④ of lifting lever fits in the work clamp foot.

After the replacement, securely tighten setscrews ③ in the work clamp foot guide.

### 1-12. Replacing the feed plate of the sewing machine

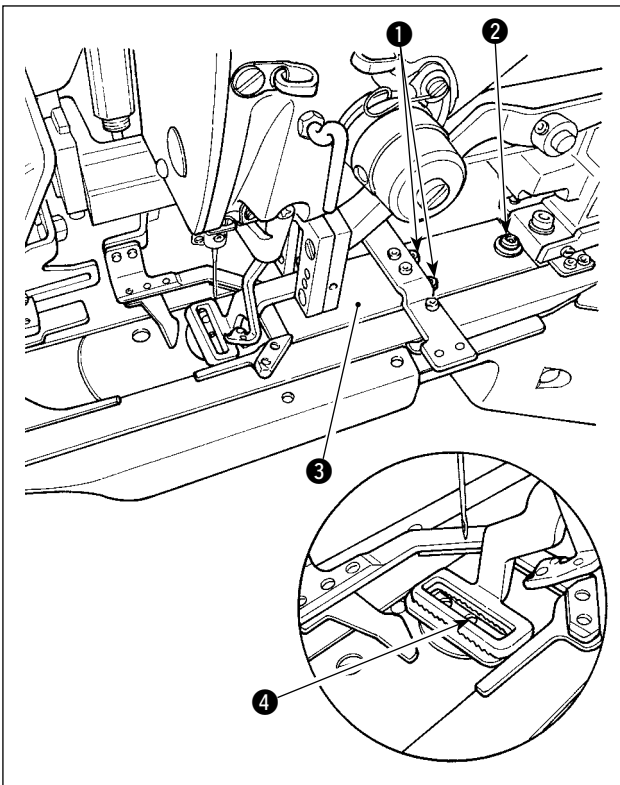

Loosen setscrews ① and ② which secure the feed plate. Slide feed plate ③ toward the operator until it comes off.

Place the replacement feed plate on the sewing machine. Check to be sure that the needle entry hole in the feed plate is positioned at center ④ of the needle hole in the throat plate, and securely tighten setscrews ① and ②.

The work clamp foot for the linear bartacking and that for the zigzag bartacking respectively need exclusive feed plate of the sewing machine. Be sure to change the feed plate with the correct one whenever you change the type of the work clamp foot of the sewing machine.



Whenever the work clamp foot and feed plate of the sewing machine are replaced with those for zigzag bartacking, the position of the garment-body presser has to be changed accordingly. (Refer to "I-2-4 (2) Work clamp foot of the sewing machine", p.7.)

### 1-13. Replacing the fork

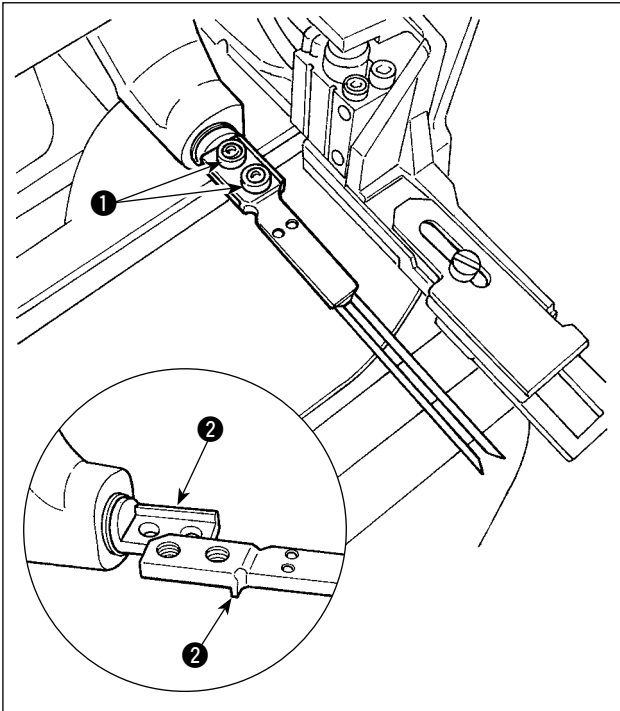

For the fork, the pin section is integral with the base section. To replace the fork, both the pin section and the base section have to be replaced together.

Loosen two setscrews ❶ and replace the fork pin asm. with a new one.

The fork pin is to be mounted with fitted in seating section ❷ in terms of both the longitudinal and lateral directions as shown in the figure at left. Be sure to securely tighten setscrews ❶ with the fork pressed against the seating section.



The fork section is always pressed by the work clamp foot of the sewing machine. Daily checkup is necessary to check whether the fork pin is damaged, the fork is bent or the setscrews have loosened.

### 1-14. Replacing the fuse

#### WARNING:



1. To avoid electrical shock hazards, turn OFF the power and open the control box cover after about five minutes have passed.
2. Open the control box cover after turning OFF the power without fail. Then, replace with a new fuse with the specified capacity.

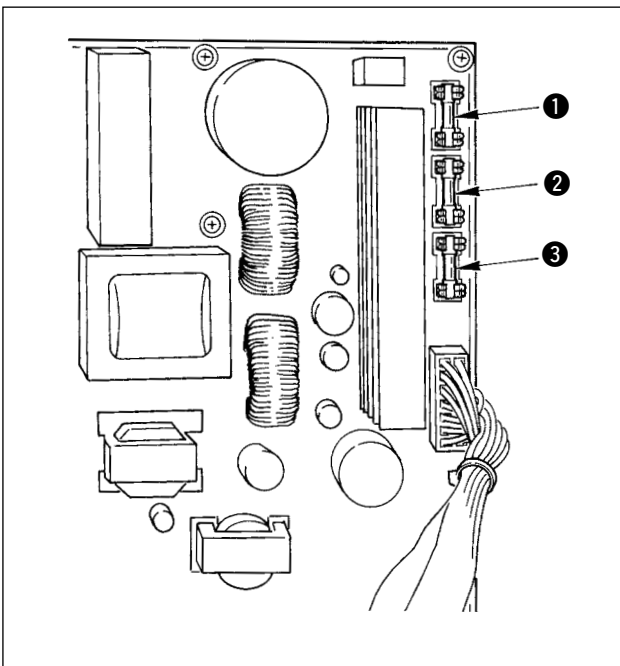

Check first that the power switch is in the OFF state, and disconnect the power cord from the wall outlet.

Then, wait for five minutes or more.

Remove four screws which secure the back cover of control box. Carefully open the back cover.

There are three fuses placed on the upper right section of the SDC PWB.

- ❶ For stepping motor power supply protection 5A (time-lag fuse)
- ❷ For solenoid power supply protection 3.15A (time-lag fuse)
- ❸ For control power supply protection 2A (fast-blow type fuse)

## 1-15. Changing the voltage of 100/200V



### WARNING:

To prevent personal injuries caused by electric shock hazards or abrupt start of the sewing machine, carry out the work after turning OFF the power switch and a lapse of 5 minutes or more. To prevent accidents caused by unaccustomed work or electric shock, request the electric expert or engineer of our dealers when adjusting the electrical components.

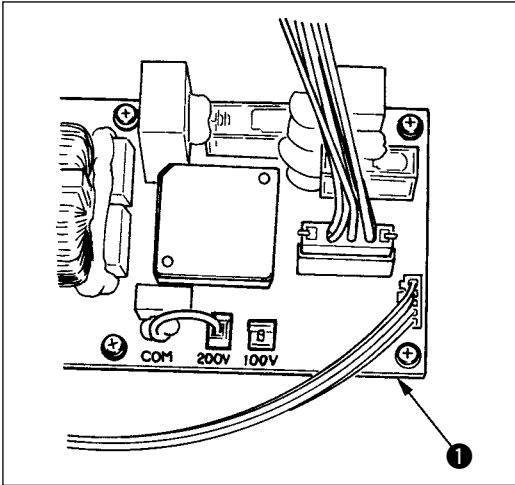

The power supply can be changed over between the “single-phase, 100V to 120V” and “3-phase 200V to 240V” by carrying out the following two steps.

- ① Replacement of the power cord
- ② Change-round of the changeover connector on the FLT PWB.

- 1) Turn OFF the power supply with the power switch after confirming that the sewing machine has stopped.
- 2) Draw out the power cord from the power plug socket after confirming that the power switch is turned OFF. Then wait for five minutes or more.
- 3) Remove four screws fixing the rear cover of the control box and slowly open the rear cover.

### [In the case the single-phase, 100V to 120V power supply is used]

Connect the AC power supply to the black and white wires of the power cord plug and the earth wire to the green/yellow wire. For the operation with the single-phase power supply, the red wire does not need to be connected. Consequently, cut both ends of the wire at the bottom of the cord.

### [In the case the 3-phase, 200V to 240V power supply is used]

Connect the AC power supply to the black, white and red wires of the power cord plug and the earth wire to the green/yellow wire. Consequently, cut both ends of the wire at the bottom of the cord.

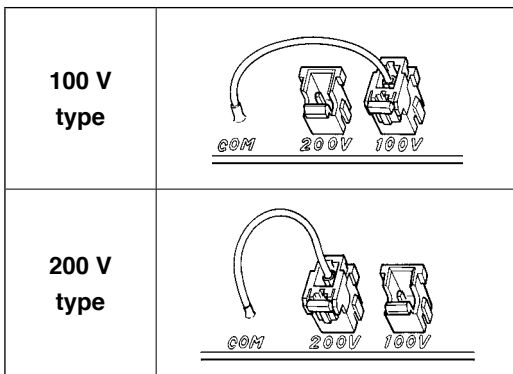

**If you make a mistake in the procedure for changing, you may damage the control box. Therefore, take extra care in the change process.**

Connect the wiring inside the power switch as shown below:

### Wiring of the single-phase 100V - 120V type machine

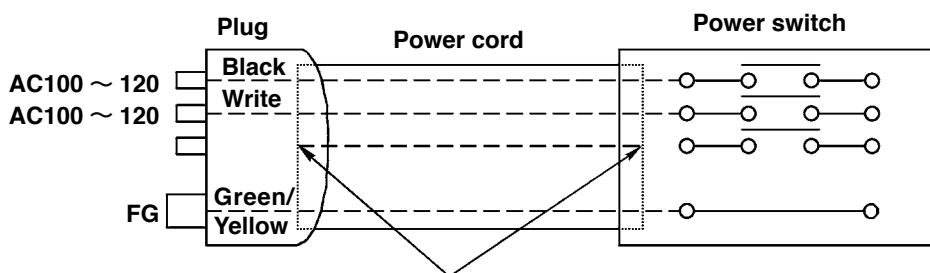

Cut both ends of the red wire.

### Wiring of the 3-phase 200V - 240V type machine

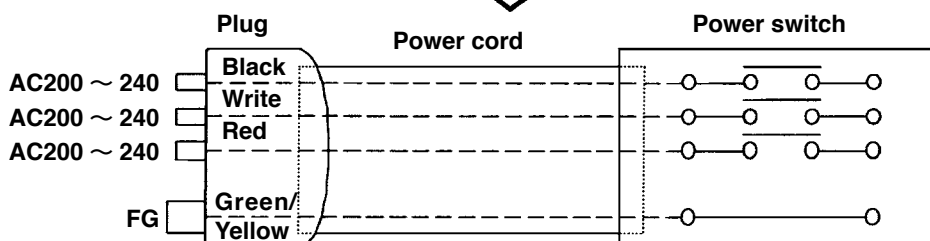

## 1-16. Replenishing the designated places with grease

- \* Perform grease supplement when the errors below are displayed or once a year (either one which is earlier). If grease has decreased due to cleaning of the sewing machine or any other reasons, be sure to immediately add grease.

### (1) Addition of grease to the machine head

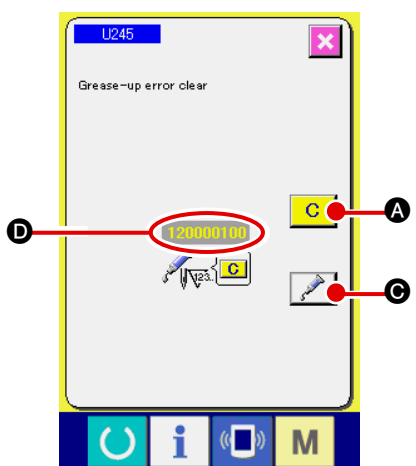
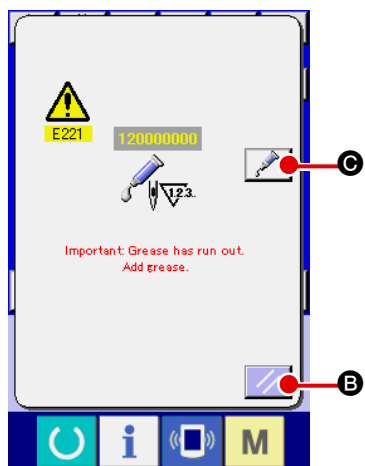
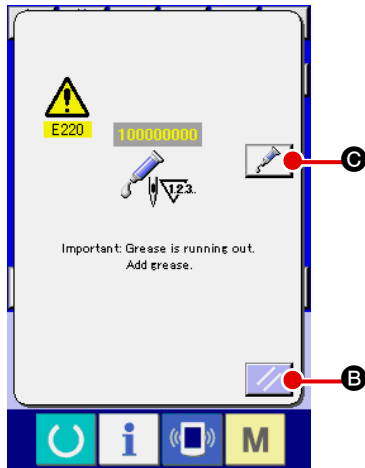

When the sewing machine has been used for a certain number of stitches, error “E220 Grease-up warning” is displayed. This display informs the operator of the time of replenishing the designated places with grease. Be sure to replenish the places with the grease below. Then call the memory switch U245, press CLEAR button **C** **A** and set NUMBER OF STITCHES **D** to “0”.

Ever after the display of the error “E220 Grease-up warning”, when RESET key **B** is pressed, the error is released, and the sewing machine can be continuously used. Afterwards, however, error code “E220 Grease-up warning” is displayed every time the power is re-turning ON.

In addition, when the sewing machine is used further for a certain period of time without replenishing the places with grease after the display of error No. E220, error “E221 Grease-up error” is displayed and the sewing machine fails to operate since the error cannot be released even when the RESET key **B** is pressed.

When error “E221 Grease-up error” is displayed, be sure to replenish the designated places below with grease. Then call the memory switch U245, press CLEAR button **C** **A** and set NUMBER OF STITCHES **D** to “0”.

When RESET key **B** is pressed without replenishing the designated places with grease, error code “E221 Grease-up warning” is displayed every time the power is re-turning ON afterwards and the sewing machine fails to operate. So, be careful.



1. Error code E220 or E221 is displayed again unless NUMBER OF STITCHES **D** is changed to “0” after replenishing the designated places with grease. When E221 is displayed, the sewing machine fails to operate. So, be careful.
2. When GREASE APPLYING POSITION DISPLAY button **C** is pressed in each screen, the grease applying position can be confirmed in the panel display. Be sure, however, to perform the grease applying after turning OFF the power.

**CAUTION :**

Turn OFF the power before starting the work so as to prevent accidents caused by abrupt start of the sewing machine.

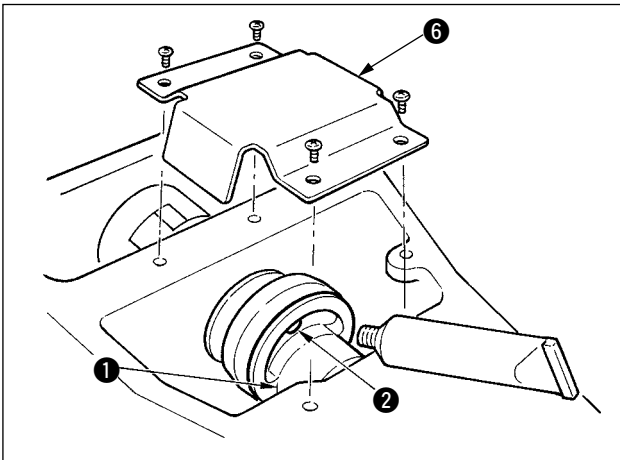
**1) Replenishing the eccentric cam section with grease**

- 1) Open the upside cover and remove the grease cover ⑥.
- 2) Remove rubber cap ② located on the side of eccentric cam ①. Then replenish there with grease.

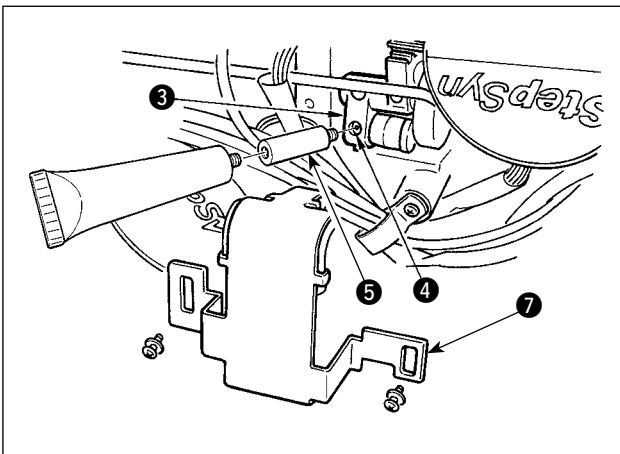
**2) Replenishing the oscillator pin section with grease**

- 1) Tilt the machine head and remove the grease cover ⑦.
- 2) Remove setscrew ④ in oscillator gear ③, screw in the grease tube attached joint ⑤ supplied as accessories, and replenish there with the grease.
- 3) Securely tighten setscrew ④ which has been removed after replenishing with the grease.



## (2) Addition of grease to devices

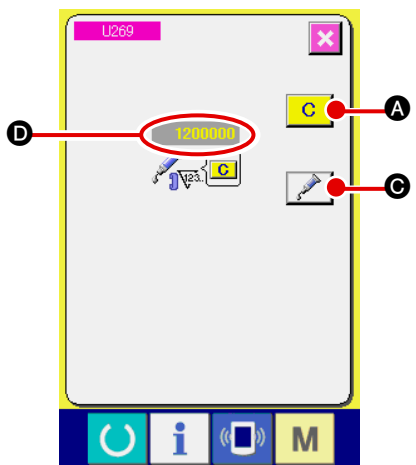
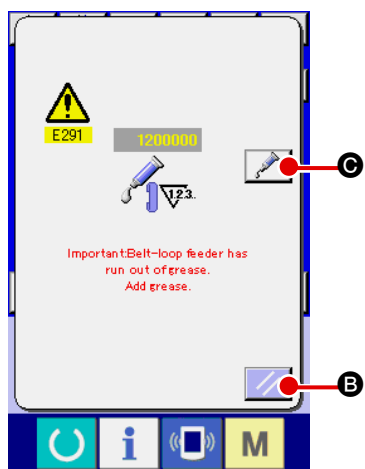
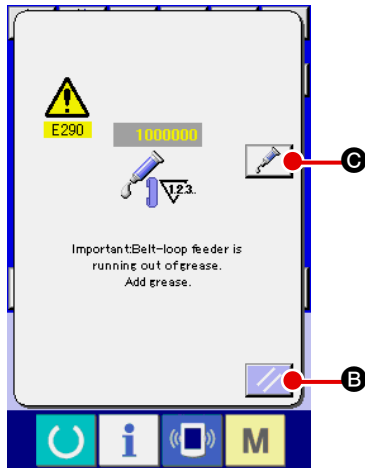

When the sewing machine has been used for a certain number of stitches, error “E290 Grease-up warning” is displayed. This display informs the operator of the time of replenishing the designated places with grease. Be sure to replenish the places with the grease below. Then call the memory switch U269, press CLEAR button **C** **A** and set NUMBER OF STITCHES **D** to “0”.

Ever after the display of the error “E290 Grease-up warning”, when RESET key **B** is pressed, the error is released, and the sewing machine can be continuously used. Afterwards, however, error code “E290 Grease-up warning” is displayed every time the power is re-turning ON.

In addition, when the sewing machine is used further for a certain period of time without replenishing the places with grease after the display of error No. E290, error “E291 Grease-up error” is displayed and the sewing machine fails to operate since the error cannot be released even when the RESET key **B** is pressed.

When error “E291 Grease-up error” is displayed, be sure to replenish the designated places below with grease. Then call the memory switch U269, press CLEAR button **C** **A** and set NUMBER OF STITCHES **D** to “0”.

When RESET key **B** is pressed without replenishing the designated places with grease, error code “E291 Grease-up warning” is displayed every time the power is re-turning ON afterwards and the sewing machine fails to operate. So, be careful.

- 1. Error code E290 or E291 is displayed again unless NUMBER OF STITCHES **D** is changed to “0” after replenishing the designated places with grease. When E291 is displayed, the sewing machine fails to operate. So, be careful.**

**2. When GREASE APPLYING POSITION DISPLAY button **C** is pressed in each screen, the grease applying position can be confirmed in the panel display. Be sure, however, to perform the grease applying after turning OFF the power.**





**CAUTION :**  
Turn OFF the power before starting the work so as to prevent accidents caused by abrupt start of the sewing machine.

### 1) Adding grease to the Y linear guide section

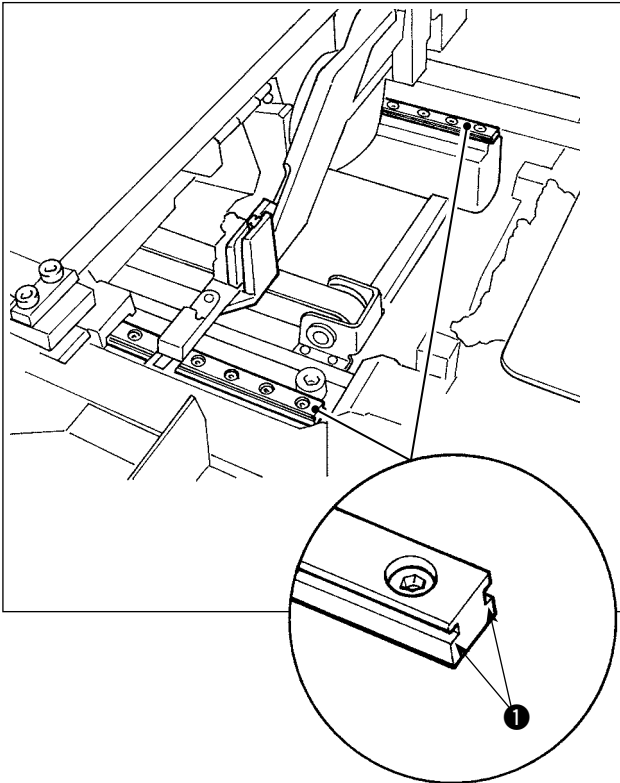

Remove the exterior cover. Add grease to the entire part of two right and left rail sections ❶ of the LM guide of the belt-loop feeder unit.

### 2) Adding grease to the belt-loop clamp linear guide section

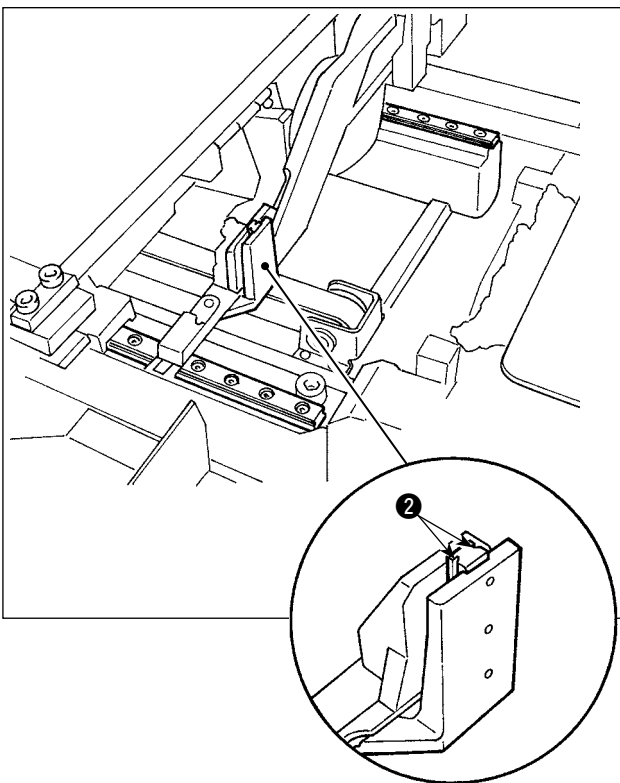

Add grease to rail section ❷ of the belt-loop clamp linear guide.

## 1-17. Troubles and corrective measures (sewing conditions)

Trouble	Cause	Corrective measures	Page
1. The needle thread slips off at the start of bar-tacking.	① Stitches are slipped at the start.	○ Adjust the clearance between the needle and the shuttle to 0.05 to 0.1 mm.	131
	② The needle thread remaining on the needle after thread trimming is too short.	○ Set the sewing machine so that the sewing speed is lowered at the beginning of sewing.	95
	③ The bobbin thread is too short.	○ Correct the thread tension release timing of the thread tension controller No. 2.	-
	④ Needle thread tension at 1st stitch is too high.	○ Increase the tension of the thread take-up spring, or decrease the tension of the thread tension controller No. 1.	18,19
	⑤ Thread clamp is unstable (material is apt to be expanded, thread is hard to slide, thread is thick, etc.).	○ Decrease the tension of the bobbin thread.	18
	⑥ Thread clamp is unstable (material is apt to be expanded, thread is hard to slide, thread is thick, etc.).	○ Increase the clearance between the needle hole guide and the counter knife.	132
2. Thread often breaks or synthetic fiber thread splits finely.	① The shuttle or the driver has scratches.	○ Decrease the tension at 1st stitch.	95
	② The needle hole guide has scratches.	○ Decrease the number of rotation at 1st stitch at the sewing start. (Extent of 600 to 1,000 sti/min)	95
	③ The needle strikes the work clamp foot.	○ Increase the number of stitches of thread clamp to 3 to 4 stitches.	96
	④ Fibrous dust is in the groove of the shuttle race.	○ Make the pitch at 1st stitch longer.	-
	⑤ The needle thread tension is too high.	○ Decrease the needle thread tension at 1st stitch.	95
	⑥ The tension of the thread take-up spring is too high.	○ Take it out and remove the scratches using a fine whetstone or buff.	-
	⑦ The synthetic fiber thread melts due to heat generated on the needle.	○ Buff or replace it.	-
3. The needle often breaks.	① The needle is bent.	○ Correct the position of the work clamp foot.	-
	② The needle hits the work clamp foot.	○ Replace the bent needle.	16
	③ The needle is too thin for the material.	○ Correct the position of the work clamp foot.	-
	④ The driver excessively bends the needle.	○ Replace it with a thicker needle according to the material.	16
	⑤ Needle thread is stepped on by the work clamp foot at the start of sewing. (Needle bend)	○ Correctly position the needle and the shuttle.	131
4. Threads are not trimmed.  (Bobbin thread only)	① The counter knife is dull.	○ Widen the distance between the needle and the wiper. (16 to 18 mm)	133
	② The difference in level between the needle hole guide and the counter knife is not enough.		
	③ The moving knife has been improperly positioned.	○ Replace the counter knife.	132
	④ The last stitch is skipped.	○ Increase the bend of the counter knife.	132
	⑤ Bobbin thread tension is too low.	○ Correct the position of the moving knife.	132
5. Stitch skipping often occurs.	① The motions of the needle and shuttle are not properly synchronized.	○ Correct the timing between the needle and the shuttle.	131
	② The clearance between the needle and shuttle is too large.	○ Increase the bobbin thread tension.	18
	③ The needle is bent.		
	④ The driver excessively bends the needle.	○ Correct the positions of the needle and shuttle.	131

<b>Trouble</b>	<b>Cause</b>	<b>Corrective measures</b>	<b>Page</b>
6. The needle thread comes out on the wrong side of the material.	<ul style="list-style-type: none"> <li>① The needle thread tension is not high enough.</li> <li>② The tension release mechanism fails to work properly.</li> <li>③ The needle thread after thread trimming is too long.</li> <li>④ Number of stitches is too few.</li> <li>⑤ When sewing length is short (End of needle thread protrudes on the wrong side of sewing product.)</li> <li>⑥ Number of stitches is too few.</li> </ul>	<ul style="list-style-type: none"> <li>○ Increase the needle thread tension.</li> <li>○ Check whether or not the tension disc No. 2 is released during bartacking.</li> <li>○ Increase the tension of the thread tension controller No. 1.</li> <li>○ Turn OFF the thread clamp.</li> <li>○ Turn OFF the thread clamp.</li> <li>○ Use the drop-in type feed plate.</li> </ul>	<p>18</p> <p>-</p> <p>18</p> <p>96</p> <p>96</p> <p>-</p>
7. Threads break at time of thread trimming.	<ul style="list-style-type: none"> <li>① The moving knife has been improperly position.</li> </ul>	<ul style="list-style-type: none"> <li>○ Correct the position of the moving knife.</li> <li>○ Turn OFF the thread clamp.</li> </ul>	<p>132</p> <p>96</p>
8. The thread clamp is entangled with needle thread.	<ul style="list-style-type: none"> <li>① The needle thread at the sewing start is too long.</li> </ul>	<ul style="list-style-type: none"> <li>○ Tighten thread tension controller No. 1 and make the length of needle thread 33 to 36 mm.</li> </ul>	<p>18</p>
9. Uneven length of the needle thread.	<ul style="list-style-type: none"> <li>① The tension of thread take-up spring is too low.</li> </ul>	<ul style="list-style-type: none"> <li>○ Increase the tension of the thread take-up spring.</li> </ul>	<p>19</p>
10. The length of needle thread does not become short.	<ul style="list-style-type: none"> <li>① The tension of thread tension controller No. 1 is too low.</li> <li>② The tension of thread take-up spring is too high.</li> <li>③ The tension of thread take-up spring is too low and motion is unstable.</li> </ul>	<ul style="list-style-type: none"> <li>○ Increase the tension of thread tension controller No. 1.</li> <li>○ Decrease the tension of thread take-up spring.</li> <li>○ Increase the tension of thread take-up spring and lengthen the stroke as well.</li> </ul>	<p>18</p> <p>19</p> <p>19</p>
11. The knotting section of bobbin thread at 2nd stitch at the sewing start appears on the right side.	<ul style="list-style-type: none"> <li>① Idling of bobbin is large.</li> <li>② The bobbin thread tension is too low.</li> <li>③ The needle thread tension at 1st stitch is too high.</li> </ul>	<ul style="list-style-type: none"> <li>○ Adjust the position of the moving knife.</li> <li>○ Increase the bobbin thread tension.</li> <li>○ Decrease the needle thread tension at 1st stitch.</li> <li>○ Turn OFF the thread clamp</li> </ul>	<p>132</p> <p>18</p> <p>95</p> <p>95</p>
12. Belt-loop length is not constant.	<ul style="list-style-type: none"> <li>① Belt-loop is caught in some part of its route.</li> <li>② Belt-loop tension is not adequate when it is being drawn out.</li> </ul>	<ul style="list-style-type: none"> <li>○ Adjust so that the belt-loop is fed smoothly without being hitched.</li> <li>○ Adequately adjust the belt-loop tension when it is being drawn out.</li> </ul>	<p>23</p> <p>24</p>
13. Lateral position of the belt-loop is not consistent.	<ul style="list-style-type: none"> <li>① The belt-loop slide guides are positioned to provide a larger width than the belt-loop width, or are installed with tilted.</li> <li>② The position of belt-loop clamp C provides a larger width than the belt-loop width.</li> </ul>	<ul style="list-style-type: none"> <li>○ Adjust the belt-loop slide guides so that they are in parallel to each other according to the belt-loop width.</li> <li>○ Adjust the position of belt-loop clamp C to the belt-loop width.</li> </ul>	<p>25</p> <p>25</p>
14. Dog-eared belt-loop is produced.	<ul style="list-style-type: none"> <li>① The fork pin has flaws or is bent.</li> <li>② The fork pin is installed with tilted.</li> </ul>	<ul style="list-style-type: none"> <li>○ Replace the fork pin with a flawless new one.</li> <li>○ Install the fork pin with its tilt corrected.</li> </ul>	<p>136</p> <p>136</p>

## 2. Option

### 2-1. Optional parts

Part name	Part number	Usage
High-voltage transformer	40005422	To correspond to the high-voltage (380 V/400 V/415 V), the high-voltage transformer, shown in the left column is to be retrofitted to the machine.
Throat plate N asm.	40091154	Throat plate asm. for small-in-width bartacking up to 14 mm

### 2-2. Gauges

Part name	Part number	Usage
Work clamp foot AN	40091157	Work clamp foot for linear bartacking width of which is up to 14 mm
Work clamp foot BW	40066686	Work clamp foot for zigzag bartacking
Work clamp foot BN	40091156	Work clamp foot for zigzag bartacking width of which is up to 14 mm
Feed plate B	40066744	Feed plate for zigzag bartacking
Feed plate BN	40075979	Feed plate for zigzag bartacking width of which is up to 14 mm
Feed plate C	40093451	Drop-in type feed plate for linear bartacking
Garment-body presser BF	40091931	Garment-body presser on the operator side for narrow garment bodies

### 2-3. Miscellaneous

Part name	Part number	Usage
Sponge blank	40091162	Sponge blank (200 x 100) installed as standard on the machine

### 2-4. Silicon oil pipes



**CAUTION :**  
Turn OFF the power before starting the work so as to prevent accidents caused by abrupt start of the sewing machine.

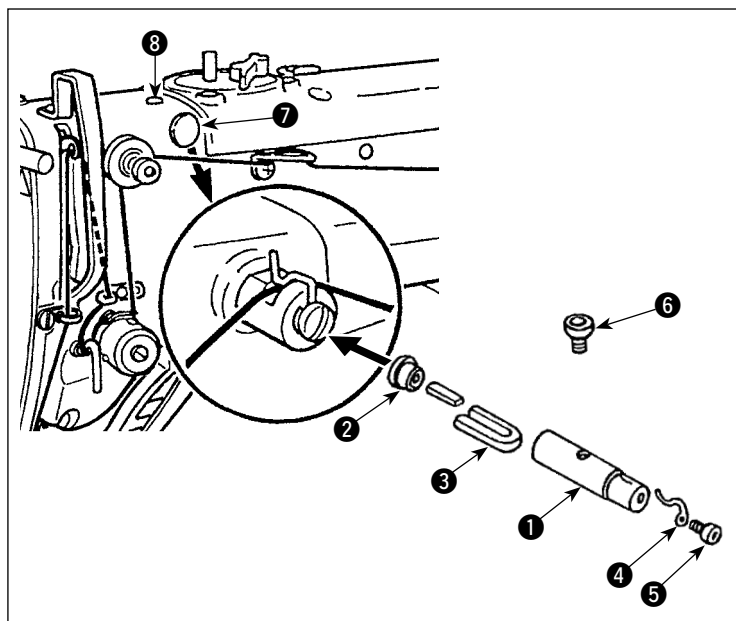

Remove plugs ⑦ and ⑧ on the machine head. Fix silicon oil pipes ① to ⑤ on the machine head with the fixing screw.

	Part name	Part number
①	Silicon oil pipe	40040910
②	Plug	TA1050504R0
③	Felt	13501705
④	Thread guide	B1127280000
⑤	Thread guide setscrew	SS4110515SP
⑥	Fixing screw for the silicon oil inlet and silicon oil pipes	13501408