

ENGLISH

**LBH-1790A,1795A
INSTRUCTION MANUAL**

CONTENTS

| | |
|--|-----------|
| I. IMPORTANT SAFETY INSTRUCTIONS | 1 |
| II. SPECIFICATIONS..... | 1 |
| 1. Specifications..... | 2 |
| 2. Standard sewing shape list..... | 3 |
| 3. Configuration | 4 |
| III. INSTALLATION..... | 5 |
| IV. PREPARATION BEFORE OPERATION..... | 15 |
| 1. Lubrication | 15 |
| 2. Inserting the needle..... | 16 |
| 3. Threading the needle-thread..... | 17 |
| 4. Threading the bobbin case | 17 |
| 5. Adjusting the bobbin thread tension | 18 |
| 6. Installation of bobbin case..... | 18 |
| 7. Installing the knife | 19 |
| 8. Checking the sewing machine in the delivered state..... | 19 |
| V. OPERATION OF THE SEWING MACHINE..... | 20 |
| 1. Explanation of the operation panel switch..... | 20 |
| 2. Basic operation of the sewing machine | 22 |
| 3. How to use the pedal..... | 23 |
| 4. Input of the presser type | 25 |
| 5. Performing pattern selection..... | 26 |
| 6. Changing needle thread tension | 27 |
| 7. Performing re-sewing..... | 28 |
| 8. Winding bobbin thread..... | 29 |
| 9. Using the counter | 30 |
| 10. Using the initial value pattern..... | 32 |
| 11. Changing sewing data..... | 33 |
| 12. Method of setting sewing data with/without edit..... | 35 |
| 13. Sewing data list..... | 36 |
| 14. Copying sewing pattern | 42 |
| 15. How to edit/check the data other than sewing data | 43 |
| 16. Using parameter register key | 45 |
| 17. Performing continuous stitching | 46 |
| 18. Performing cycle stitching..... | 49 |
| 19. How to change the name of cycle/continuous sewing data | 51 |
| 20. Explanation of plural motions of knife..... | 52 |
| 21. Method of changing memory switch data | 53 |
| 22. Memory switch data list | 54 |
| 23. How to change the sewing speed while the sewing machine is engaged in sewing | 58 |
| 24. How to adjust the pedal variable resistor..... | 59 |

| | |
|--|-----------|
| 25. How to adjust the contrast..... | 60 |
| 26. How to set the key lock | 60 |
| 27. Communication..... | 61 |
| VI. MAINTENANCE..... | 64 |
| 1. Adjusting the needle-to-hook relation | 64 |
| 2. Adjusting the needle thread trimmer | 65 |
| 3. Adjusting the presser bar pressure | 66 |
| 4. Adjustment of the bobbin presser unit..... | 66 |
| 5. Thread tension | 67 |
| 6. Replacing the fuse | 68 |
| VII. GAUGE COMPONENTS | 69 |
| 1. Cloth cutting knife | 69 |
| 2. Throat plate | 69 |
| 3. Presser..... | 69 |
| VIII. ERROR CODE LIST | 70 |
| IX. TROUBLES AND CORRECTIVE MEASURES..... | 76 |
| X. DRAWING OF THE TABLE..... | 78 |
| XI. INITIAL VALUE DATA FOR EACH SHAPE TABLE | 80 |

I. IMPORTANT SAFETY INSTRUCTIONS

- 1) Never operate the machine unless the oiling tank has been properly lubricated.
- 2) After the completion of a day's work, remove dust and dirt accumulating on the hook, bobbin thread trimming knife section and lubricating hole of the oil tank. At this time, also check whether or not the oil quantity is adequate.
- 3) Be sure to return the starting pedal to the home position after the machine has started to run.
- 4) This machine is provided with a machine head tilt detector so that it cannot be operated in the state that the machine head is tilted. When operating this sewing machine, turn the power switch ON after setting the sewing machine to the bed base properly.

II. SPECIFICATIONS

Main specifications of the LBH-1790A, LBH-1795A computer-controlled, lockstitch buttonholing machine

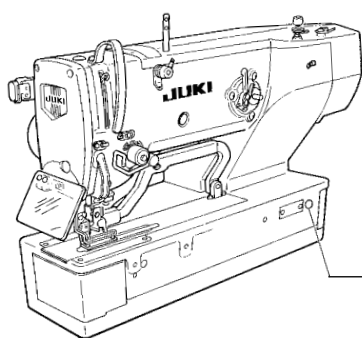



| | |
|-------------------|--|
| Subclass | Ⓢ |
| Major application | Buttonholing of cloth such as men's shirts, blouses, work uniforms, ladies' wear, etc. |
| Buttonholing size | <p>Standard : Max. 5 mm Special type part : Max. 10 mm</p> <p>Knife size used : 6.4 to 31.8 mm (1/4' to 1-1/4')</p> <p>Buttonholing sewing length Standard : Max. 41 mm Special type part : Max. 120 mm</p> |

1. Specifications

| | |
|-------------------------------------|--|
| Sewing speed | Standard speed : 3,600 sti/min (Max. : 4,200 sti/min) (Max. : 3,300 sti/min when dry hook is used) |
| Needle | DPX5 #11J to #14J |
| Hook | DP type full-rotary hook |
| Needle rocking drive method | Drive by stepping motor |
| Feed drive method | Drive by stepping motor |
| Presser lifting drive method | Drive by stepping motor |
| Lift of presser foot | 14 mm (Optional setting available) Max. : 17 mm (At the time of needle up by reverse run) |
| Cloth cutting knife drive method | Motor-driven crank system |
| Standard sewing shape | 31 kinds |
| Number of patterns stored in memory | 99 patterns |
| Weight | Machine head 55 kg, Control box 5.5 kg |
| Power consumption | 370 VA |
| Operating temperature range | 5 °C to 35 °C |
| Operating humidity range | 35% to 85% (No dew condensation) |
| Line voltage | Rated voltage \pm 10% 50/60 Hz |
| Motor used | 3-phase 200 to 240 V, 370 VA |
| Noise | - Equivalent continuous emission sound pressure level (L_{pA}) at the workstation : A-weighted value of 81.0 dB ; (Includes ; $K_{pA} = 2.5$ dB) ; according to ISO 10821- C.6.3 -ISO 11204 GR2 at 3,600 sti/min. |

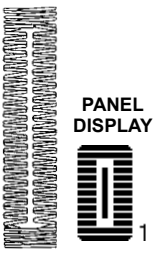
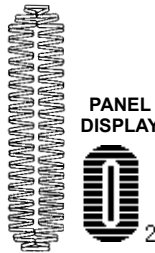
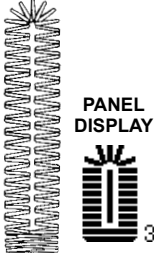
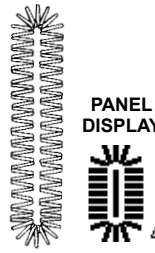
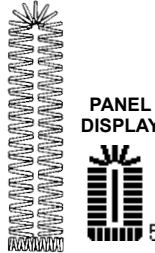
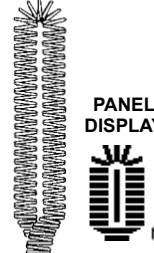
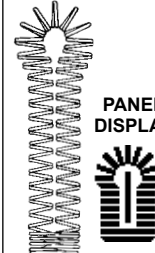
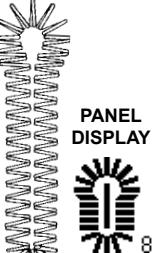
2. Standard sewing shape list

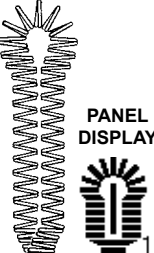
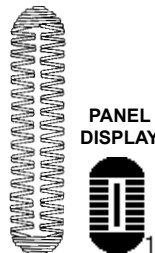
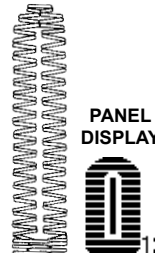
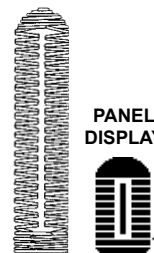
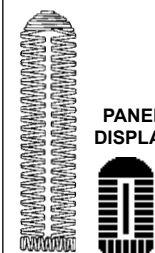
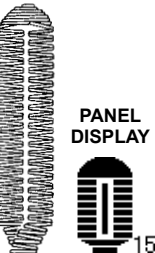
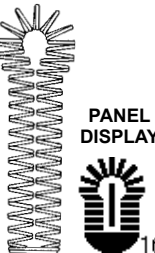
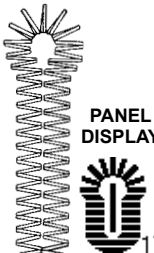
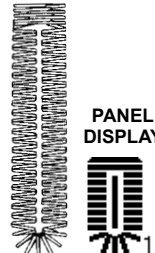
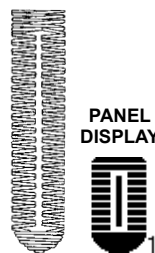
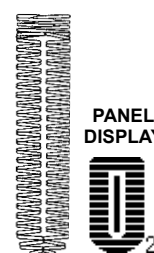
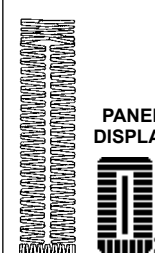
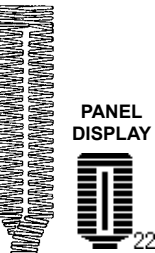
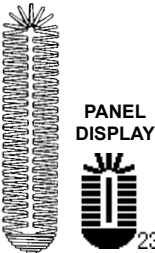
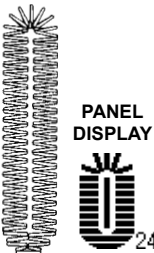
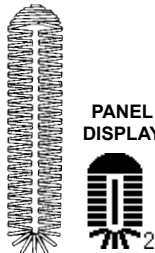
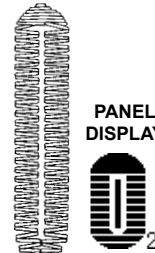
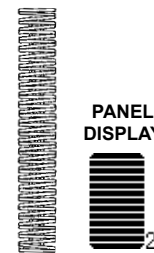
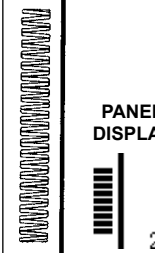
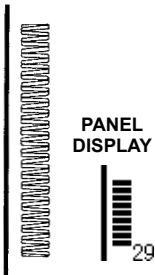
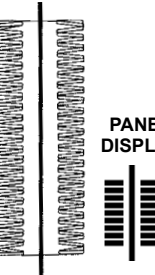
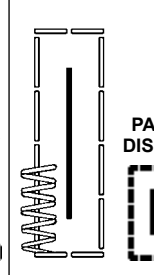
| (1) Square type | (2) Round type | (3) Radial square type | (4) Radial type | (5) Radial straight bar-tacking type | (6) Radial taper bar-tacking type | (7) Eyelet square type |
|---|---|---|---|--|---|---|
|  |  |  |  |  |  |  |
| (8) Eyelet radial type | (9) Eyelet straight bar-tacking type | (10) Eyelet taper bar-tacking type | (11) Semilunar type | (12) Round square type | (13) Semilunar square type | (14) Semilunar straight bar-tacking type |
|  |  |  |  |  |  |  |
| (15) Semilunar taper bar-tacking type | (16) Eyelet semilunar type | (17) Eyelet round type | (18) Square radial type | (19) Square semilunar type | (20) Square round type | (21) Square straight bar-tacking type |
|  |  |  |  |  |  |  |
| (22) Square taper bar-tacking type | (23) Radial semilunar type | (24) Radial round type | (25) Semilunar radial type | (26) Semilunar round type | (27) Bar-tacking | (28) Bar-tacking, right cut |
|  |  |  |  |  |  |  |
| (29) Bar-tacking, left cut | (30) Bar-tacking, center cut | (31) Basting + Cloth cutting knife | | | | |
|  |  |  | | | | |

3. Configuration

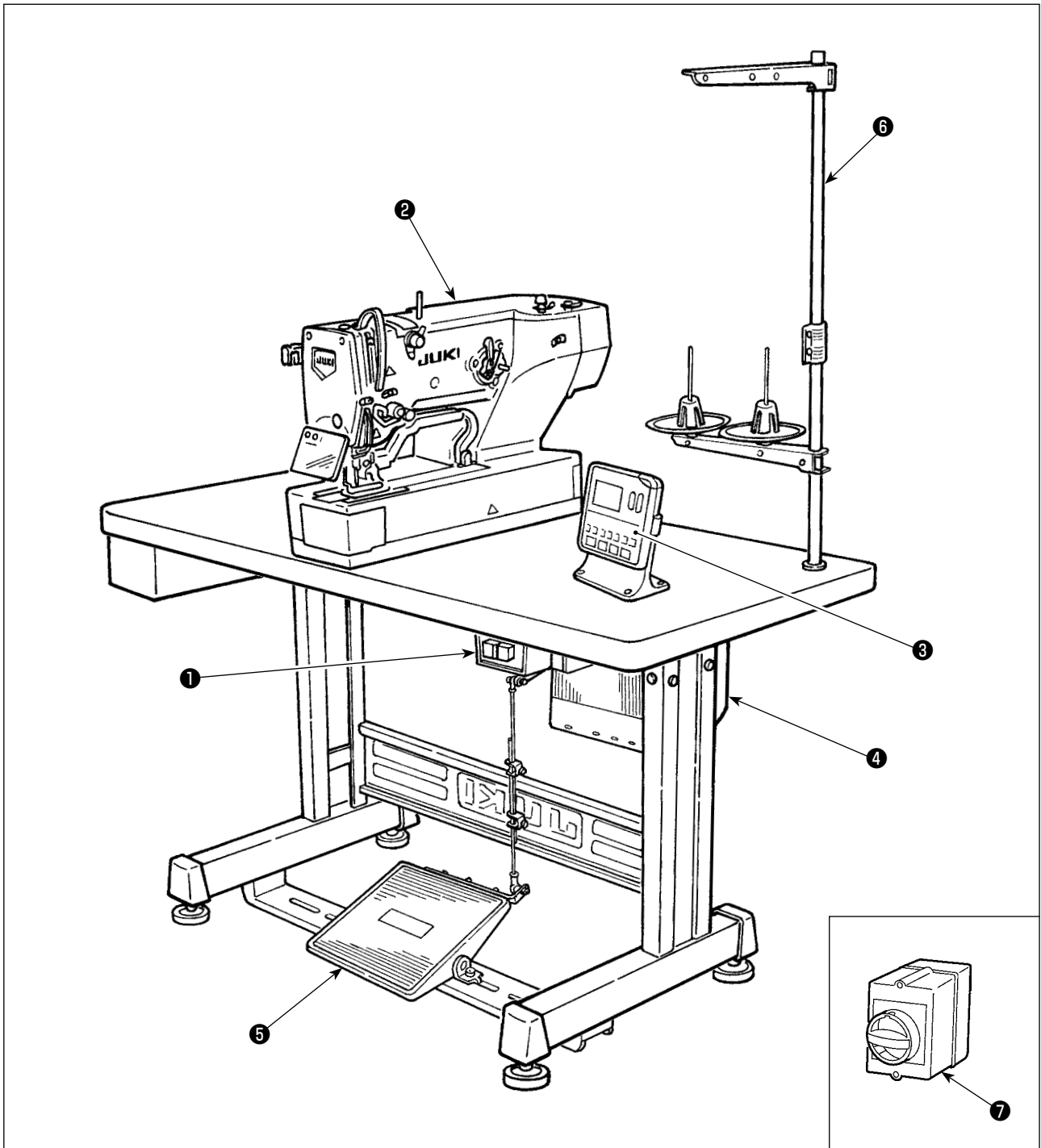

LBH-1790A, LBH-1795A consists of the following components.

| | |
|---|-------------------------------------|
| ① | Power switch |
| ② | Machine head (LBH-1790A, LBH-1795A) |
| ③ | Operation panel |
| ④ | Control box (MC-602) |
| ⑤ | Presser lifting and starting pedal |
| ⑥ | Thread stand device |
| ⑦ | Power switch (EU type) |

III. INSTALLATION



WARNING :

To prevent possible accidents caused by the fall of the sewing machine, perform the work by two persons or more when the machine is moved.

(1) Preparation for assembly of the control box

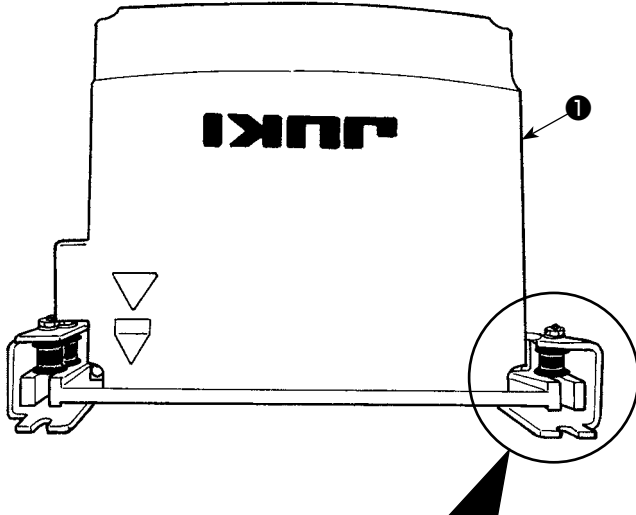

1) Fix toothed washers (2) and rubber cushions (3) on control box (1) . (At four locations)

* Tighten the toothed washers so that their height becomes 0.8 mm.

2) Fix control box mounting plate (4) with plain washers (5) , spring washers (6) and nuts (7) . (At four locations)

* Fix the mounting plate while fitting the screw in the U-groove in the mounting plate.

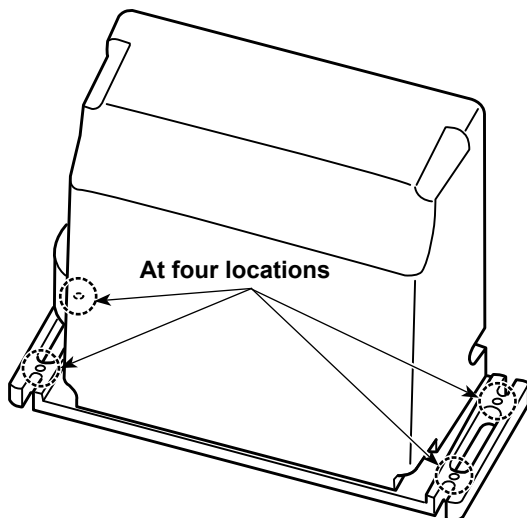
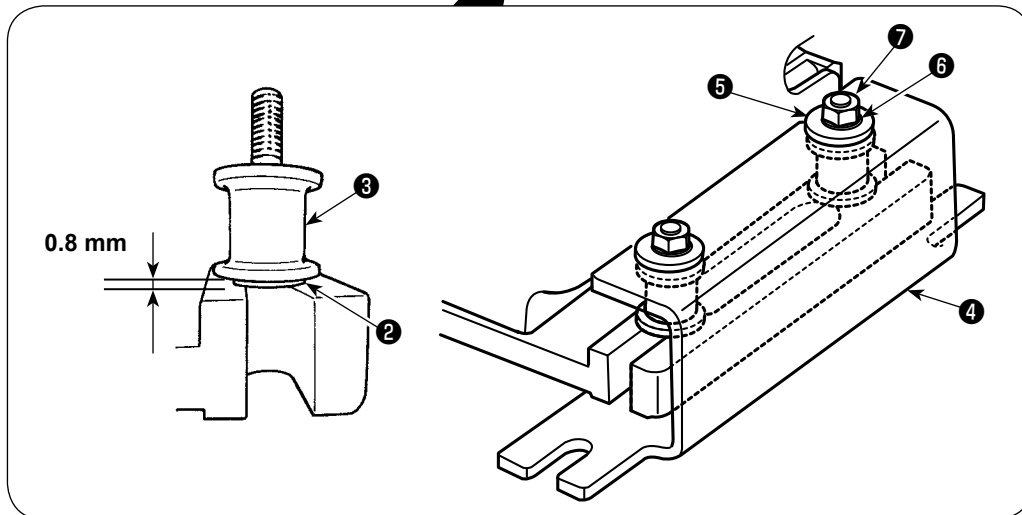

At four locations

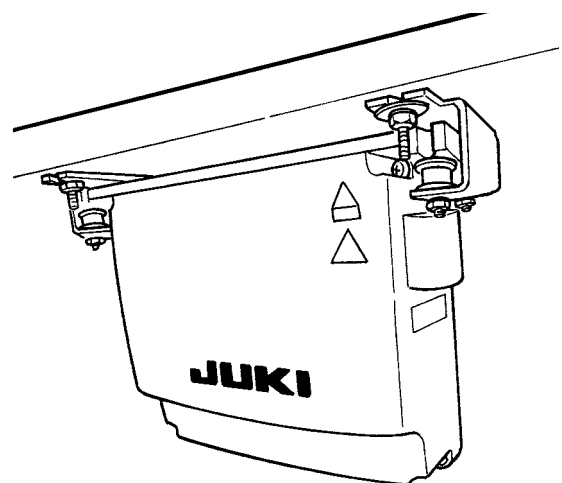

(2) Set-up of the table

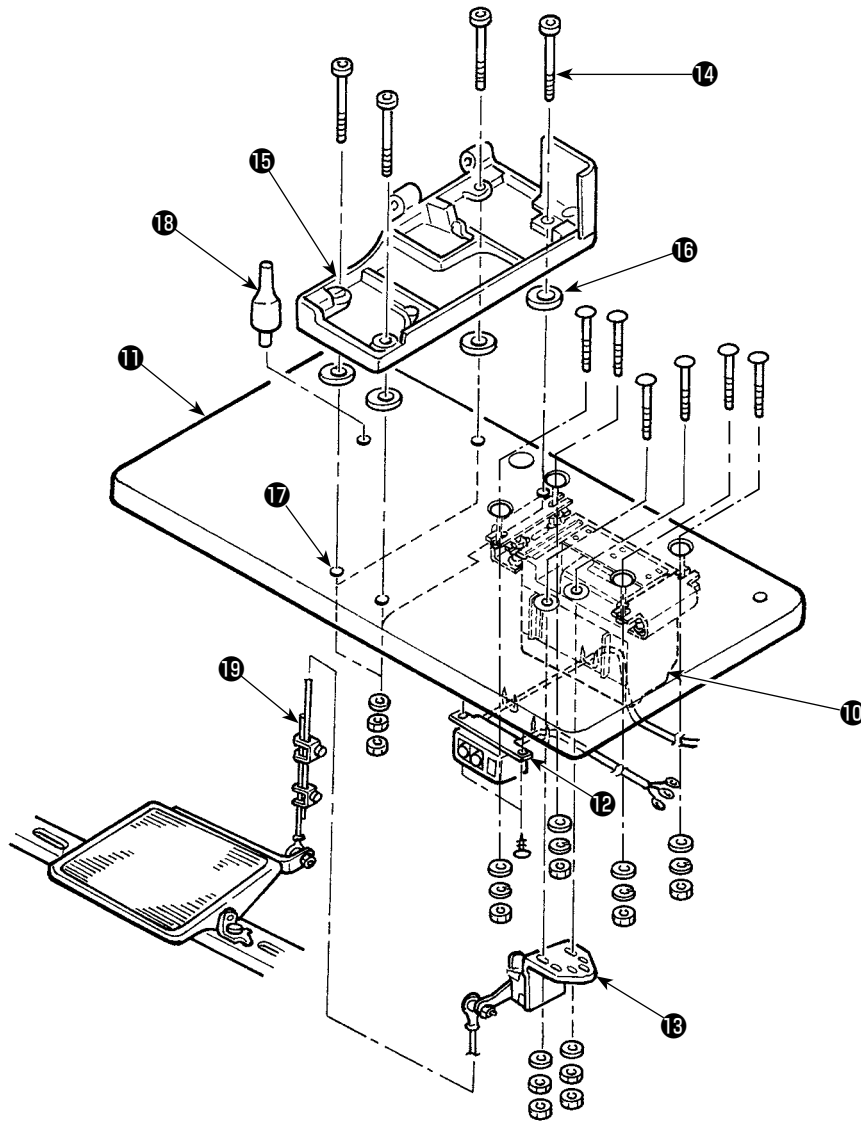

- 1) Fix control box 10 , power switch 12 and pedal sensor 13 on table 11 .
- 2) Fix power switch 12 with a staple.
- 3) Pass four bed base fixed screws 14 through bed base 15 .
- 4) Set rubber cushions 16 to holes 17 (4 places) for fixing bed base and fix bed base 15 .
- 5) Fix head support bar 18 on table 11 .
- 6) Place the main unit of the sewing machine on bed base 15 . Then, connect the pedal and pedal sensor 13 with connecting rod 19 supplied with the unit.

(3) Connecting the power source cord

- Connecting the power cable

Voltage specifications are shown on the power indication tag attached on the power cable and on the rating plate adhered on the power box. Connect the cable which matches the specifications.

Power indication tag

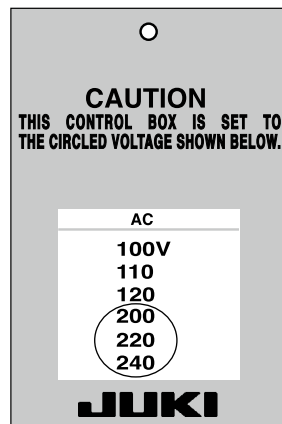

(For example: In the case of 200V)

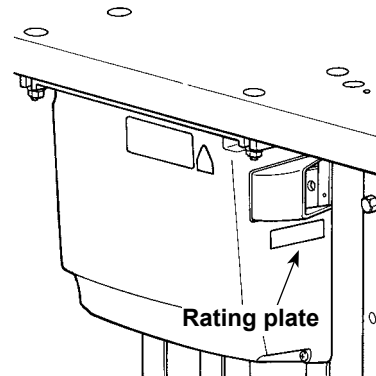

Never use under the wrong voltage and phase.

- Connecting three phase 200V, 220V and 240V

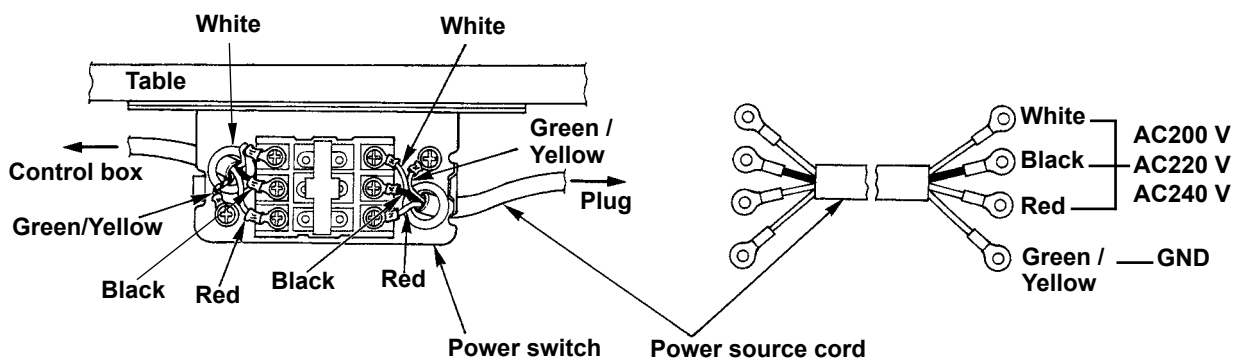

(4) Installing the sewing machine main unit

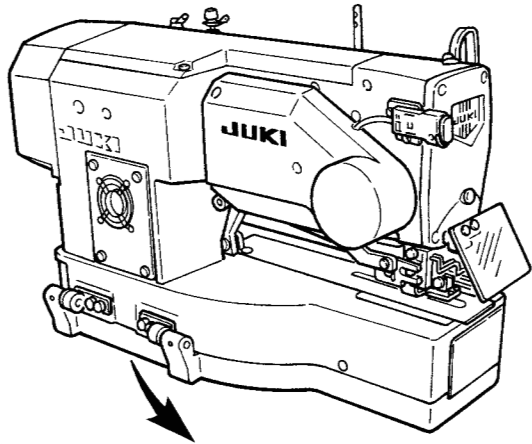

WARNING :

To prevent possible accidents caused by the fall of the sewing machine, perform the work by two persons or more when the machine is moved.

- 1) Place hinge plates ① and shaft bearings ② -1 (rubber) and ② -2 (metal) in two places on the head base and fix the hinge plates to the machine head with setscrews ③ in two places.



When the rubber hinge and metal fitting hinge are installed in reverse order, it is dangerous since the sewing machine shakes when it is tilted. So, be careful.

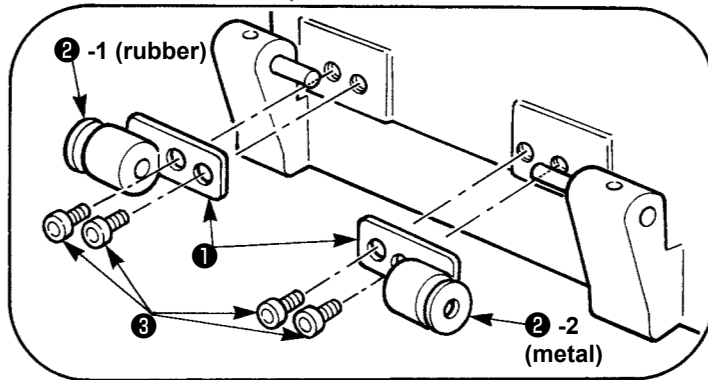

(5) Tilting the sewing machine head



WARNING :

When tilting/raising the sewing machine head, perform the work so as not to allow your fingers to be caught in the machine. In addition, to avoid possible accidents caused by abrupt start of the machine, turn OFF the power to the machine before starting the work.

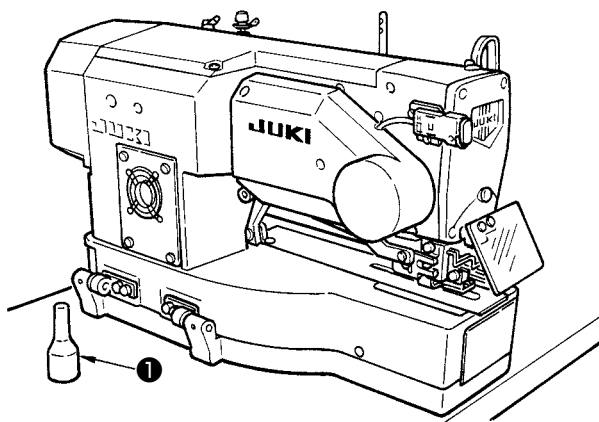

When tilting the sewing machine head, tilt quietly the sewing machine until head support bar ① comes in contact with it.



1. Make sure that sewing machine head support bar ① is placed on the table before tilting the sewing machine.
2. To protect fall-down, be sure to tilt the sewing machine in a level place.

(6) Connecting the machine head tilt detector

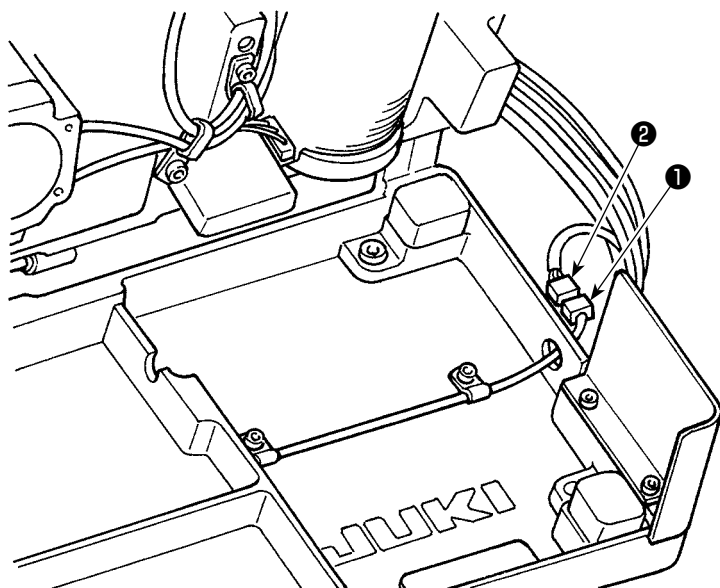

Connect machine head tilt detector ① with connector ② located on the machine head side.

(7) Installing the hook oil shield plate

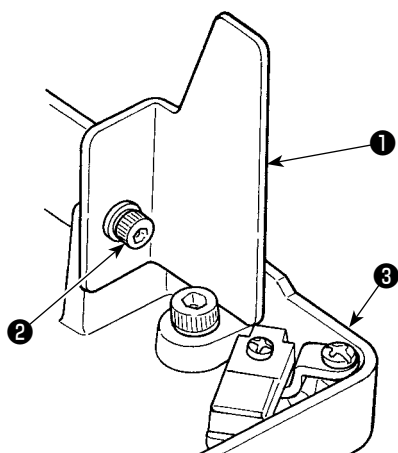

Install hook oil shield plate ① onto bed base ③ with setscrew ② .

Attach hook oil shield plate ① to the bed base with the sewing machine raised.

In addition, check to be sure that the sewing machine does not interfere with hook oil shield plate ① when tilting/raising the former.

Adjust the mounting of the hook oil shield plate ① to prevent scattered from the gap between the bed and cover pot.



(8) Installing the operation panel

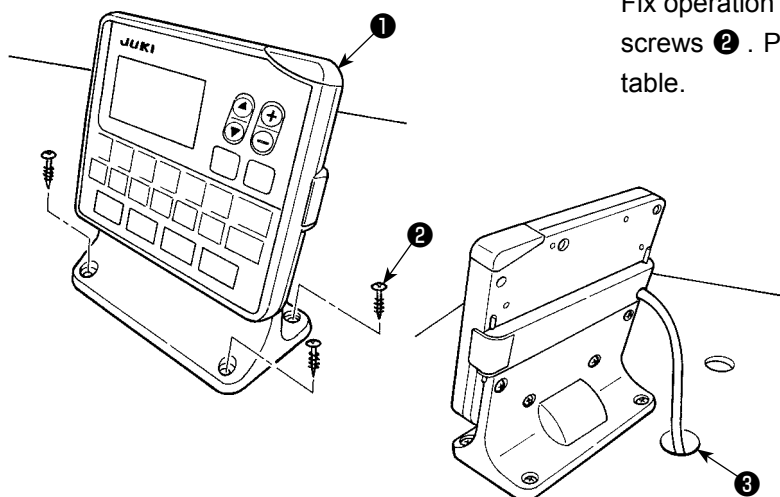

Fix operation panel ① on the table with four wood screws ② . Pass the cable through hole ③ in the table.

(9) Connecting the cords

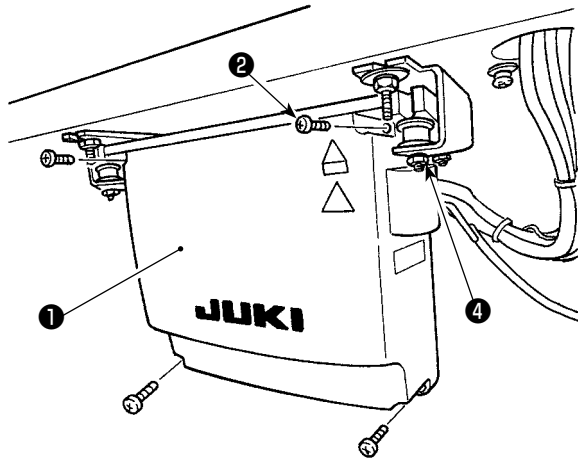

- 1) Loosen four setscrews **2** of control box cover **1**. Remove control box cover **1**.
- 2) Connect the cord to the connector on the MAIN PCB as illustrated in the figure below.
- 3) Fix the earth cord with setscrew **3**.
- 4) Install control box cover **1**.
- 5) Fix control box cover with the washers, spring washers and nuts **4**.

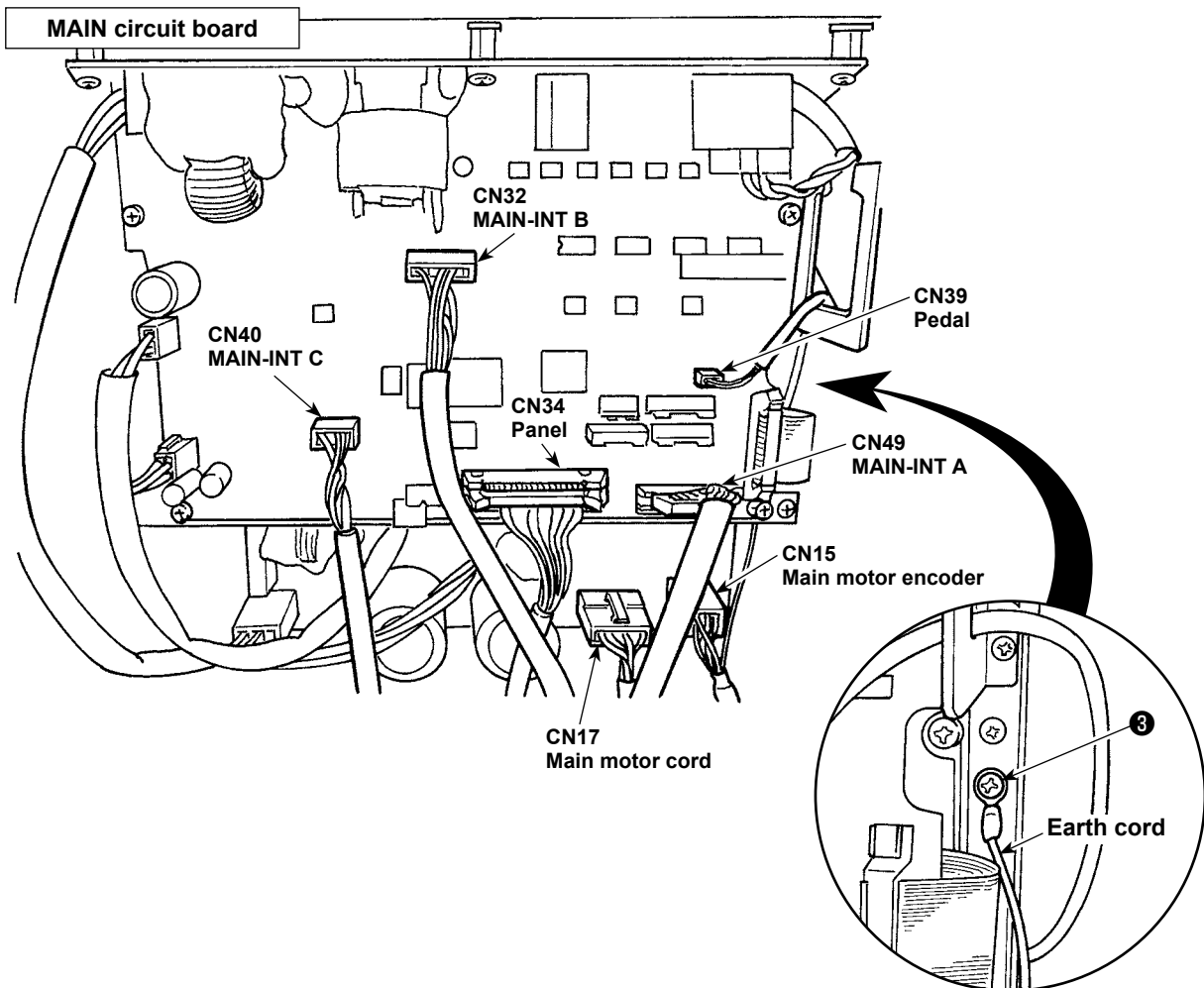
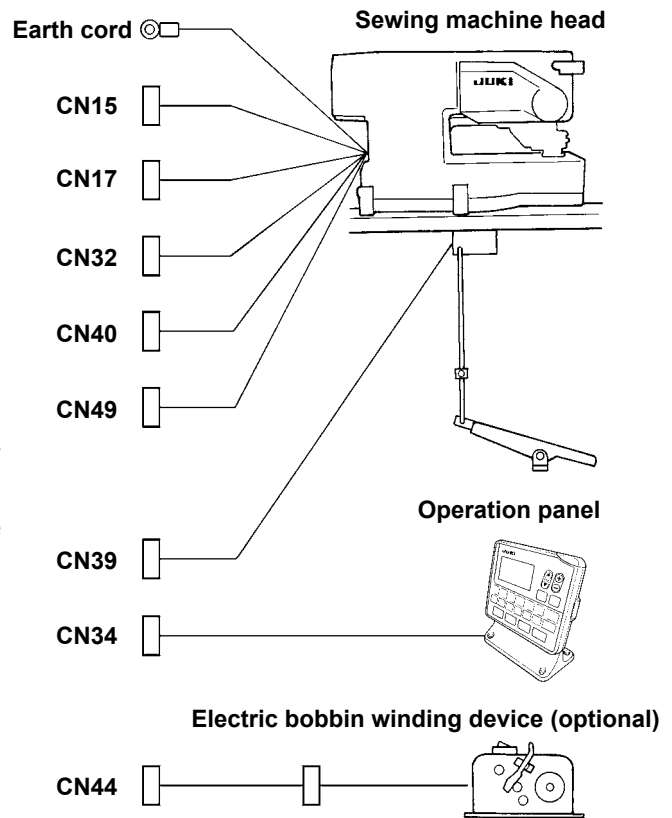

(10) Managing the cord

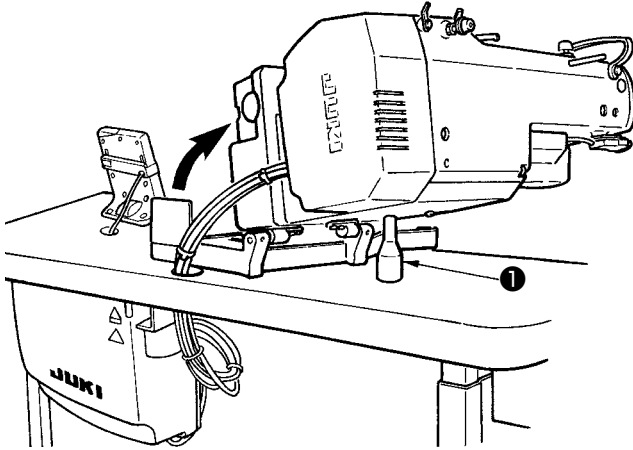

- 1) Slowly tilting the sewing machine, check that the cords are not forcibly pulled.



When you tilt the sewing machine, make sure that the sewing machine head support bar **1** is placed on the table.

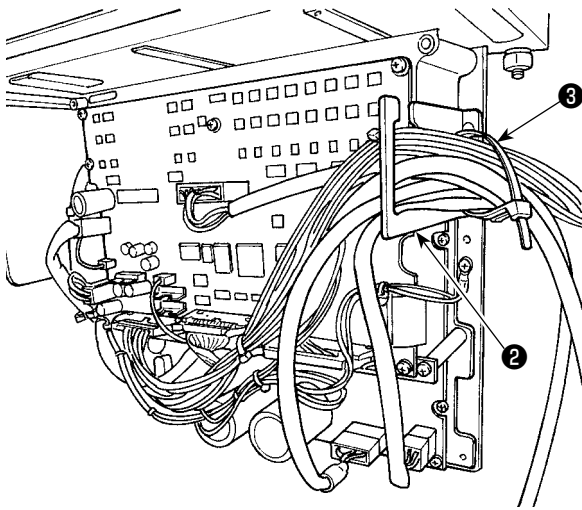

- 2) Bring the cords under the table into the control box.
- 3) Put the cord brought into the control box through cord exit plate **2** and fix cable clip band **3**.

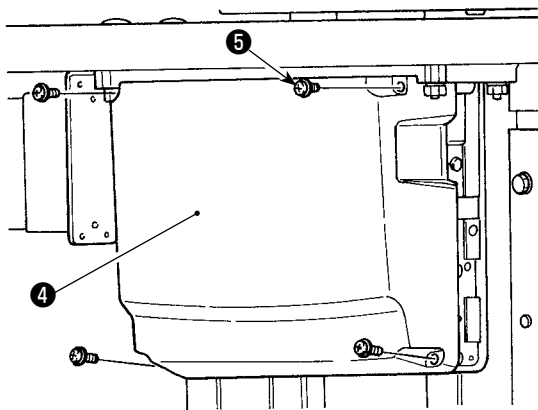

- 4) Install control box lid **4** with four set-screws **5**.

(11) Installing the eye protection cover



WARNING :

Be sure to attach this cover to protect the eyes from the disperse of needle breakage.

Be sure to install and use eye protection cover ❶ and use the sewing machine.

When placed longitudinally

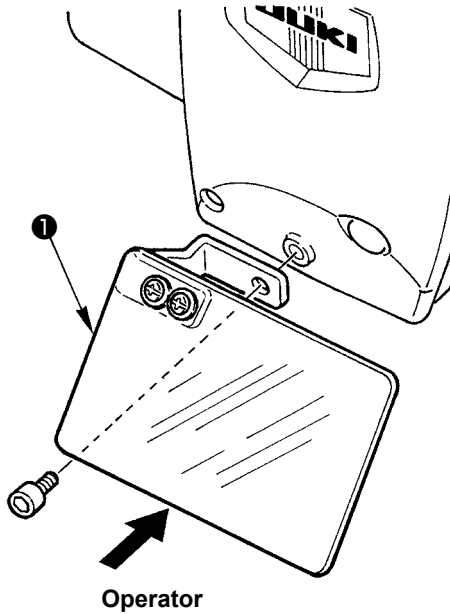

When placed horizontally

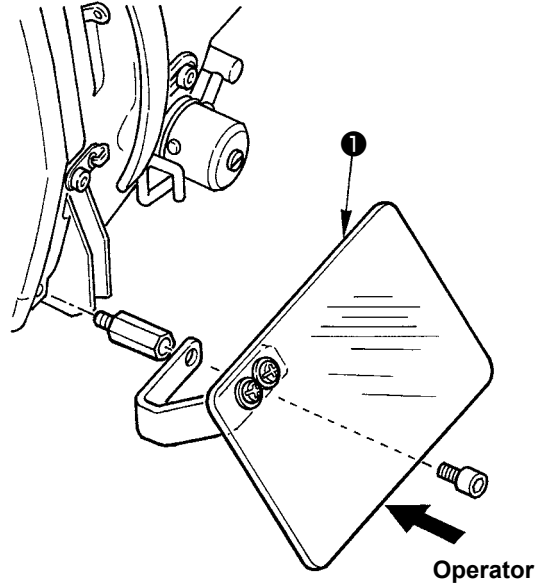

(12) Fixing the temporary stop switch

The temporary stop switch has been in the state as shown in figure A at the time of delivery.

Loosen setscrew ❶ and set the switch in the state as shown in figure B, and fix it with setscrew ❶ together with setscrew ❷ supplied with the machine.

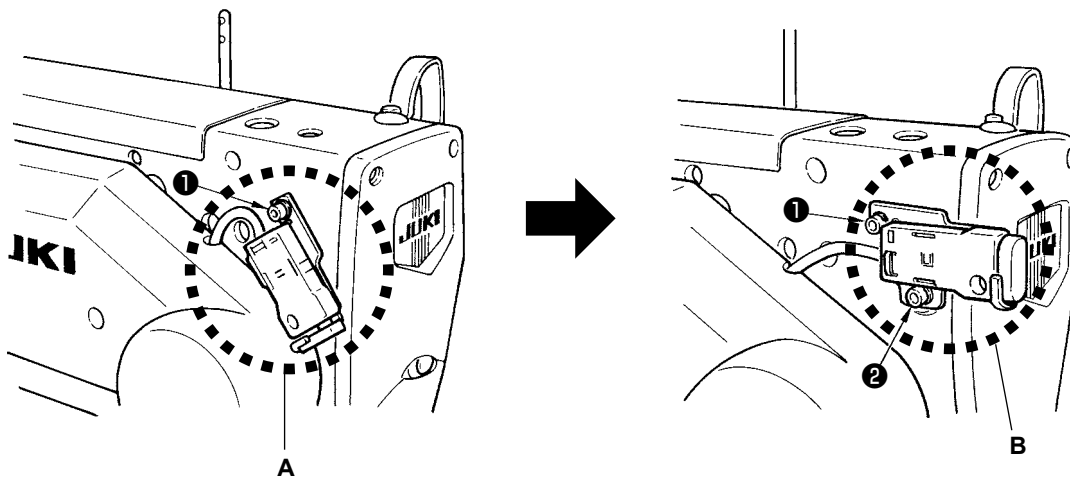

(13) Thread guide rod

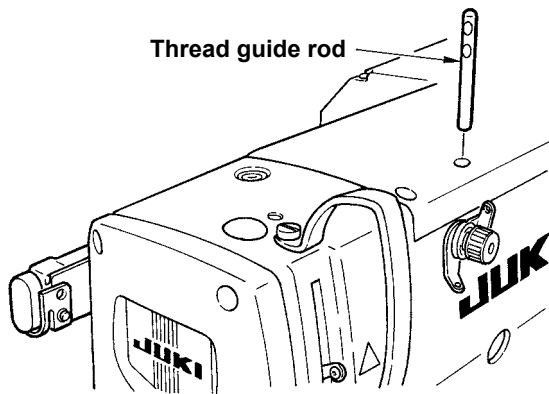

Securely fit the thread guide rod so that two side holes in the thread guide rod face the thread guide.

(14) Installing the thread stand

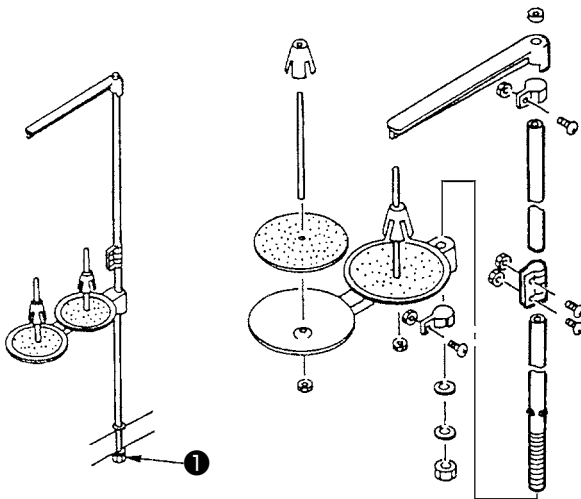

- 1) Assemble the thread stand, and set it in the hole in the top right corner of the machine table.
- 2) Tighten locknut **1** to fix the thread stand.

(15) Installing the auxiliary table

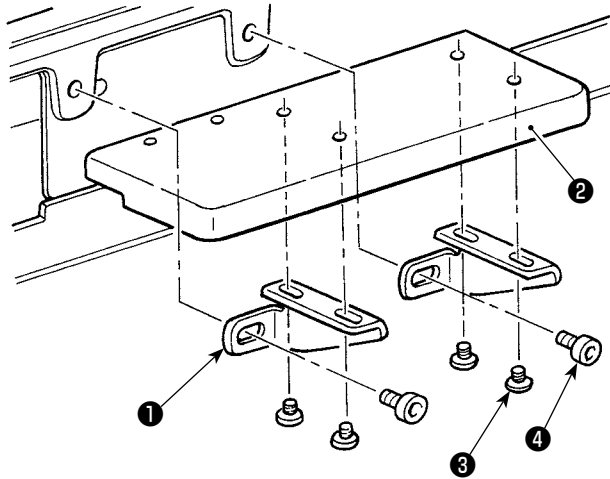

- 1) Temporarily fix two auxiliary table mounting plates **1** on auxiliary table **2** with four bolts **3**.
- 2) Temporarily fix auxiliary table **2** on the sewing machine bed with two bolts **4**.
- 3) Fix four bolts **3** while removing a clearance between the sewing machine bed and auxiliary table **2**.
- 4) Fix two bolts **4** while aligning auxiliary table **2** with the top surface of the sewing machine bed.

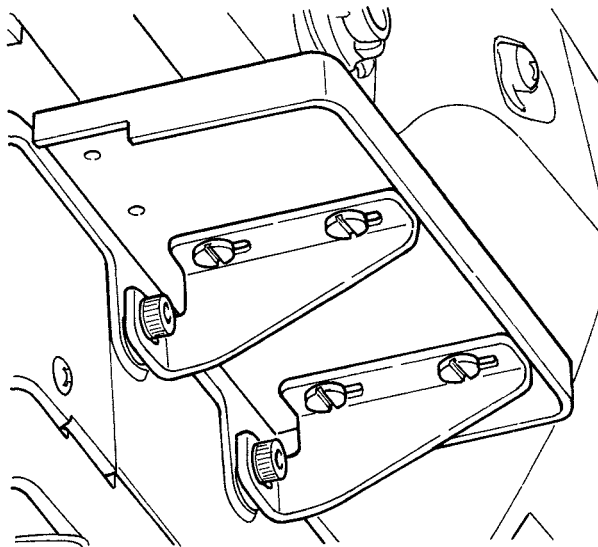

IV. PREPARATION BEFORE OPERATION

1. Lubrication



WARNING :

To protect against possible personal injury due to abrupt start of the machine, be sure to start the following work after turning the power off and ascertaining that the motor is at rest.

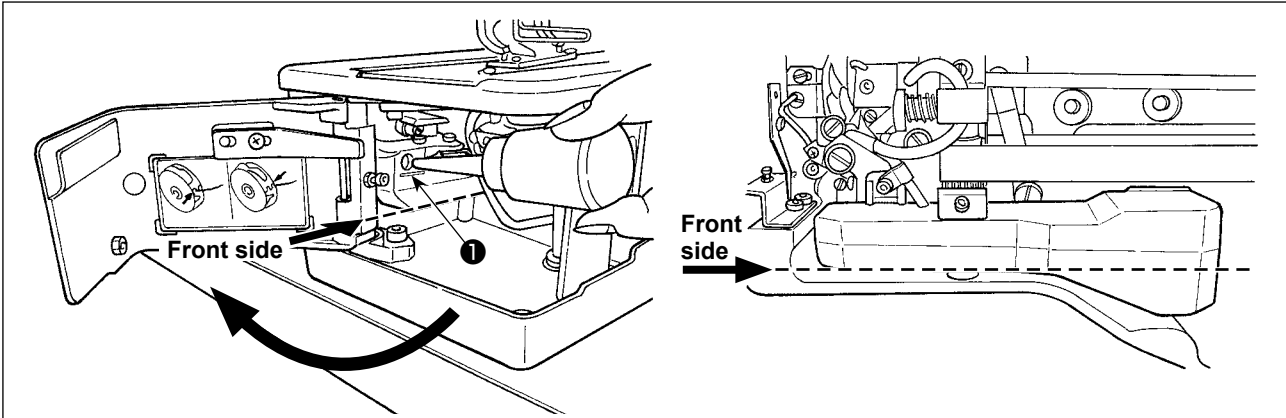

1) Lubricating oil to oiling tank

- Fill the oiling tank with JUKI New Defrix Oil No.1 up to the level indicated by “MAX” ① .
(Caution) When supplying oil to the oil tank through the lubricating hole, take care not to allow dust to enter the oil tank.
- Supply oil in the case the oil cannot be visually observed from the front side of the oil tank.

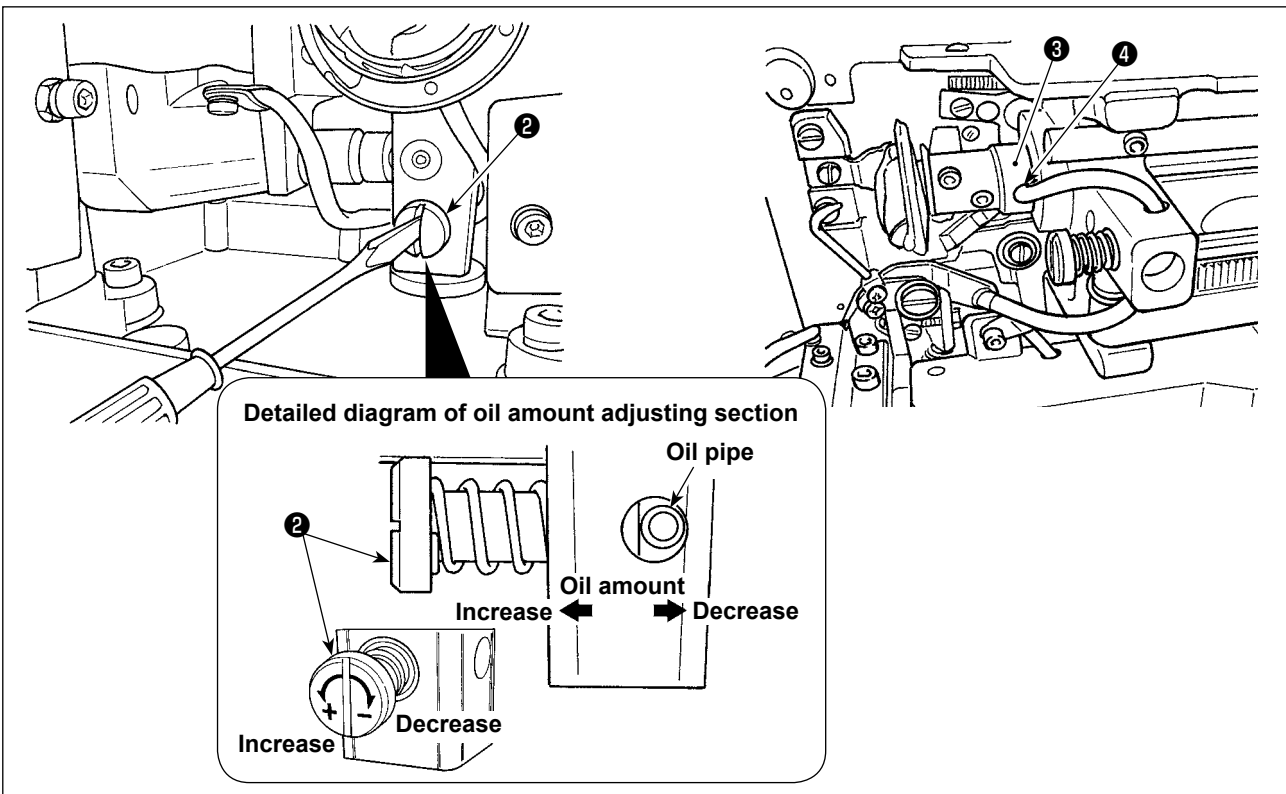

2) Adjusting the lubrication for the sewing hook

- The amount of oil is adjusted with oil amount adjusting screw ② .
- Amount of supplied oil is reduced when turning the screws ② clockwise.
- When you first operate your sewing machine after set-up or after an extended period of disuse, remove the bobbin case and apply a few drops of oil to the hook race. In addition, apply a few drops oil from oiling hole ④ in hook driving shaft front metal ③ to soak the inside felt in oil.

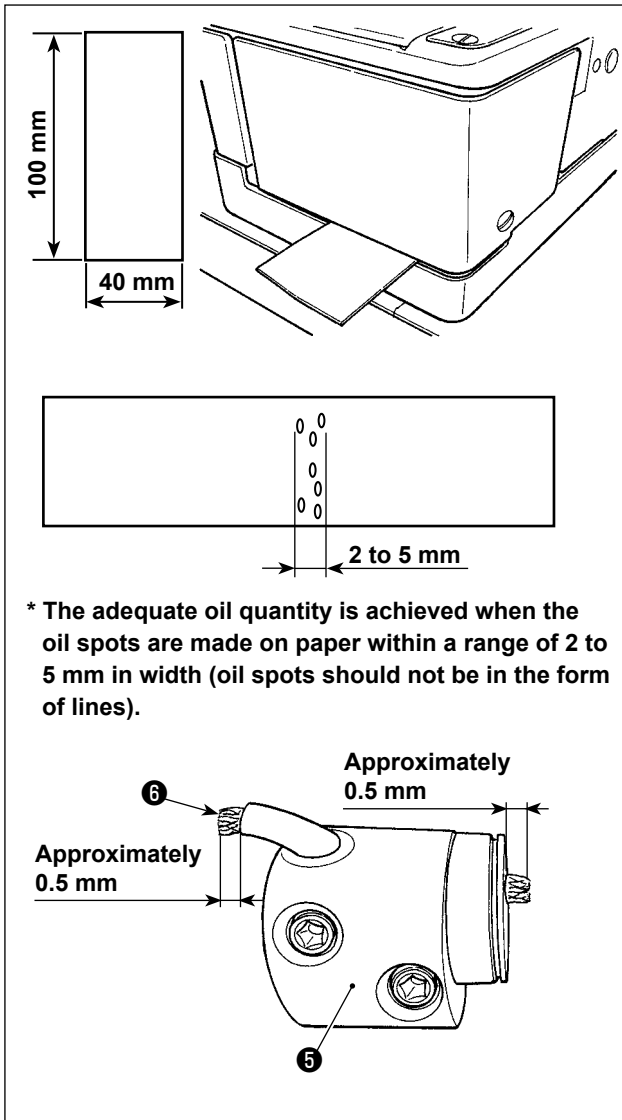

3) How to check the hook oil quantity

1. In preparation for checking the hook oil quantity, cut a sheet of paper to make a piece of paper size of which is approximately 40 mm x 100 mm.
2. After the adjustment of the oil quantity, start the sewing machine at a high speed (3,600 sti/min) by 100 times or more.
3. Insert the piece of paper prepared in Step 1 into the clearance provided between the hook cover and the bed base so that it is placed near the underside of the hook.
As a guide, insert the paper until it comes in contact with the hook oil shield.
4. Supporting the paper with hand, run the sewing machine by five cycles using the standard pattern (3,600 sti/min) and check the splashing oil quantity.

Caution
In the case the oil quantity is too much even after the oil controlling screw is fully tightened, remove the hook shaft coupling ⑤ and cut off the excess of oil wick ⑥.

2. Inserting the needle



WARNING :

To protect against possible personal injury due to abrupt start of the machine, be sure to start the following work after turning the power off and ascertaining that the motor is at rest.

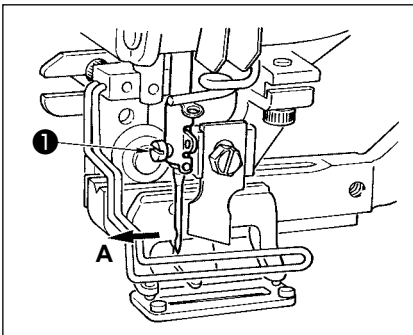

Hold needle with its recessed part facing toward the operator side **A**, insert the needle fully into the needle clamping hole, and tighten needle setscrew **1**. Use a DPx5-(#11J, #14J).



Caution
When attaching the needle, turn OFF the power to the motor.

3. Threading the needle-thread



WARNING :

To protect against possible personal injury due to abrupt start of the machine, be sure to start the following work after turning the power off and ascertaining that the motor is at rest.

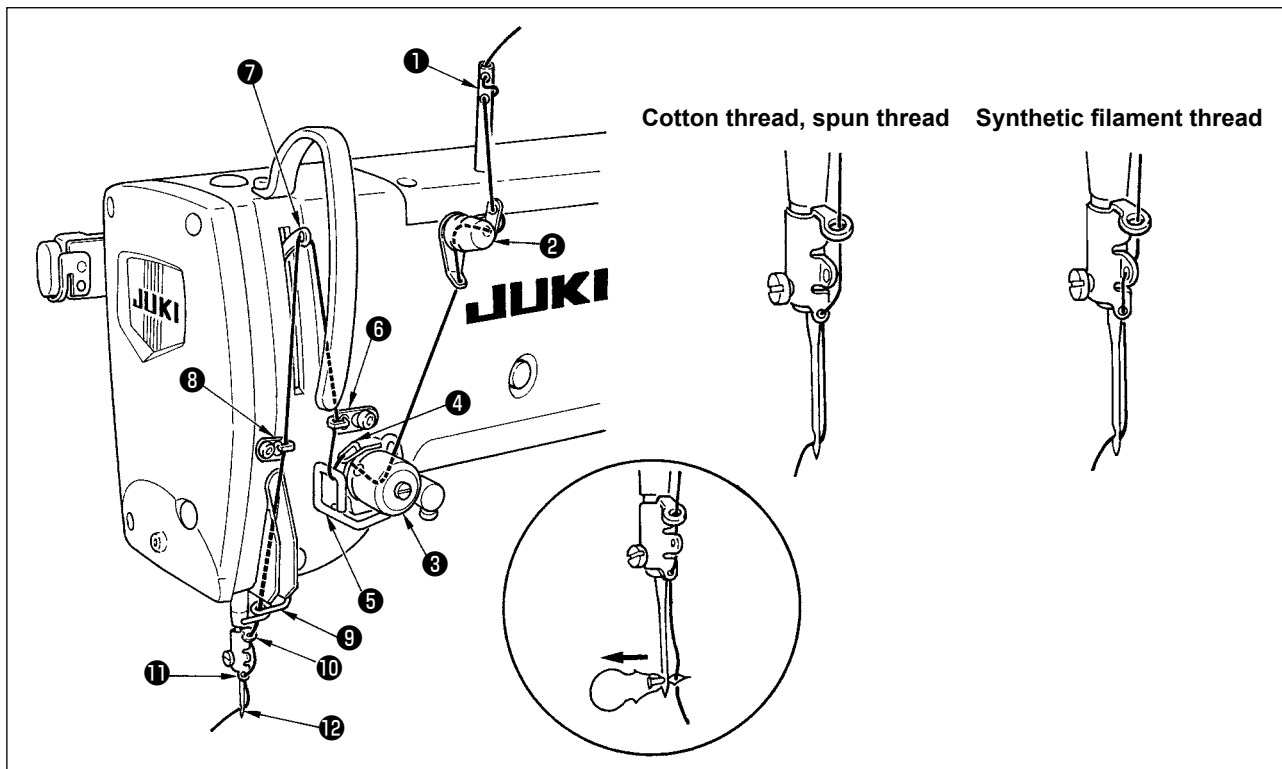

Pass the needle thread in the order ① to ⑫ as shown in the figures.

The threading can be done easily by using the needle threader supplied with the machine.

Change the thread guide threading method according to the thread to be used.

4. Threading the bobbin case

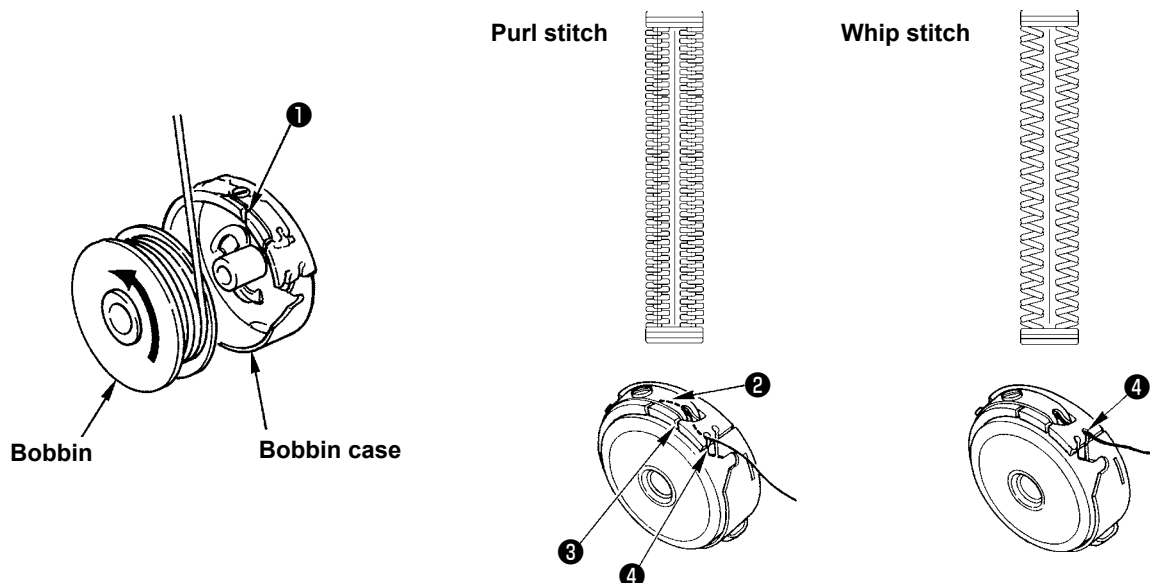

Rotating direction of bobbin and threading

- 1) Fit the bobbin so that it rotates in the direction of the arrow.
- 2) Pass the thread through thread slit ①, then through under the tension spring ②, again through thread slit ③, and pull the thread from ④.
- 3) Threading at ④ for purl stitching is different from that for whip stitching. So, be careful.

5. Adjusting the bobbin thread tension

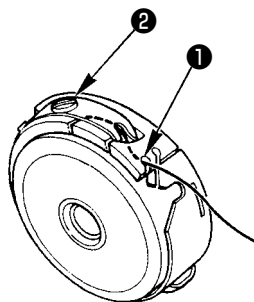

Adjust the bobbin thread tension as given below when the bobbin thread is pulled up at the position where thread slit ❶ of bobbin case comes up.

| | | |
|-------------|---------------|---|
| Purl stitch | 0.05 to 0.15N | To such an extent that bobbin case quietly comes down when holding thread end coming from bobbin case and shaking it quietly up and down. |
| Whip stitch | 0.15 to 0.3N | To such an extent that bobbin case barely comes down when holding thread end coming from bobbin case and shaking it somewhat strongly. |

Turning tension adjust screw ❷ clockwise will increase bobbin thread tension, and turning it counterclockwise will decrease the tension.

Adjust the bobbin thread tension to lower for synthetic filament thread, and to higher for spun thread. The thread tension is higher by approximately 0.05N when the bobbin case is set to the hook since idle-prevention spring is provided.



When bobbin thread tension is adjusted, check the needle thread tension setting of the memory switch. (Refer to "V-22. Memory switch data list" p.54.)

6. Installation of bobbin case



WARNING :

To protect against possible personal injury due to abrupt start of the machine, be sure to start the following work after turning the power off and ascertaining that the motor is at rest.

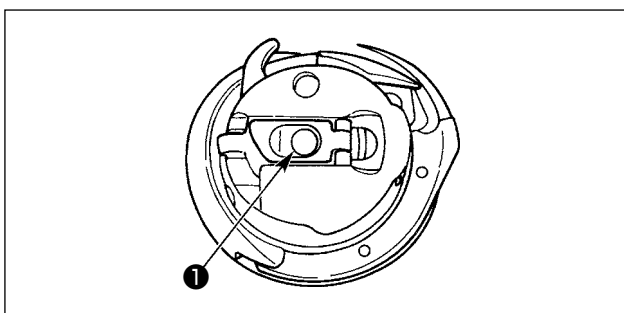

- 1) Lift up and hold bobbin case latch lever between two fingers.
- 2) Push the bobbin case into the hook so that it is supported by the hook shaft ❶ and then snap in the latch lever.

Press the bobbin case until the predetermined position is reached, and it will click.



1. If the bobbin case is out of the predetermined position, it can jump out from the hook to cause the needle thread to tangle on the hook shaft. Check to be sure that the bobbin case is properly installed in the correct position.
2. There is a difference in the shape of bobbin case between the standard hook and the dry one. They have nothing in common with each other.

7. Installing the knife



WARNING :

To protect against possible personal injury due to abrupt start of the machine, be sure to start the following work after turning the power off and ascertaining that the motor is at rest.

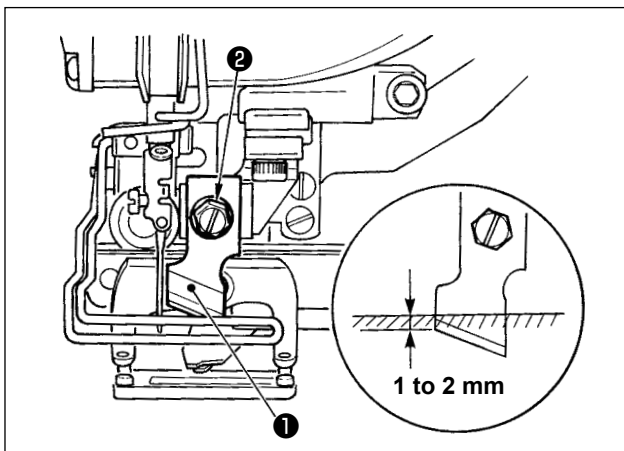

When replacing the knife with a new one, perform as follows.

- 1) Knife ① can be easily removed together with the washer when removing knife retaining screw ② .
- 2) Lower the knife bar by hand. Now, push the knife bar down so that the knife goes below the top surface of the throat plate by 1 to 2 mm, as illustrated in the figure. In this state, place the washer and tighten the setscrew.

Inch → mm CONVERSION TABLE

| Knife size | Indication of mm |
|------------|------------------|
| 1/4 | 6.40 |
| 3/8 | 9.50 |
| 7/16 | 11.10 |
| 1/2 | 12.70 |
| 9/16 | 14.30 |
| 5/8 | 15.90 |
| 11/16 | 17.50 |
| 3/4 | 19.10 |
| 13/16 | 20.60 |
| 7/8 | 22.20 |
| 1 | 25.40 |
| 1 1/8 | 28.60 |
| 1 1/4 | 31.80 |
| 1 3/8 | 34.90 |
| 1 1/2 | 38.10 |

When the cloth cutting knife you have is indicated in inch, set the cloth cutting length (knife size) in mm using the inch → mm conversion table. (Refer to "[V-13. Sewing data list](#)" p.36.)

8. Checking the sewing machine in the delivered state

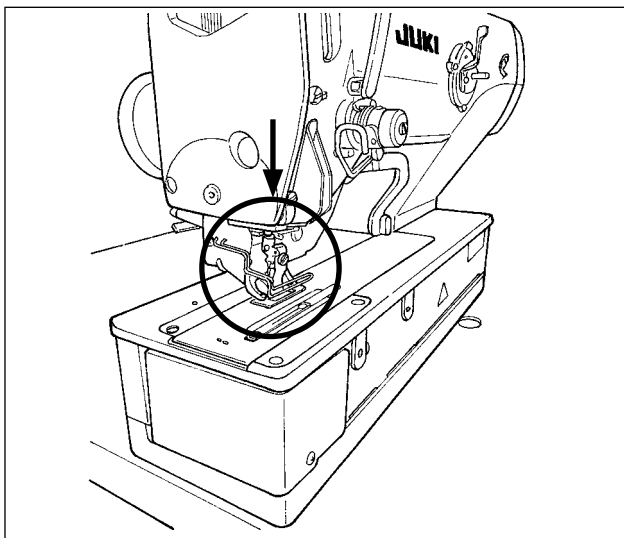

If the work clamp foot is the lifted state before turning the power ON, lower it firstly and turn ON the power to the sewing machine.











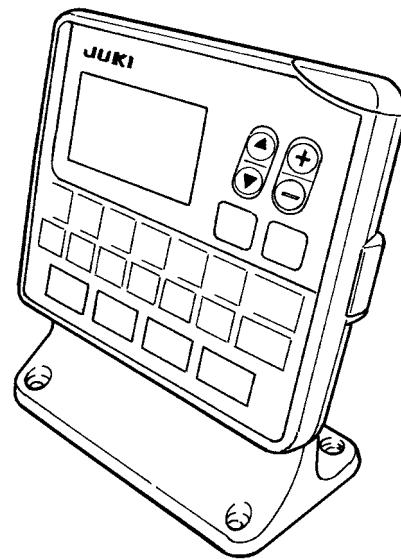
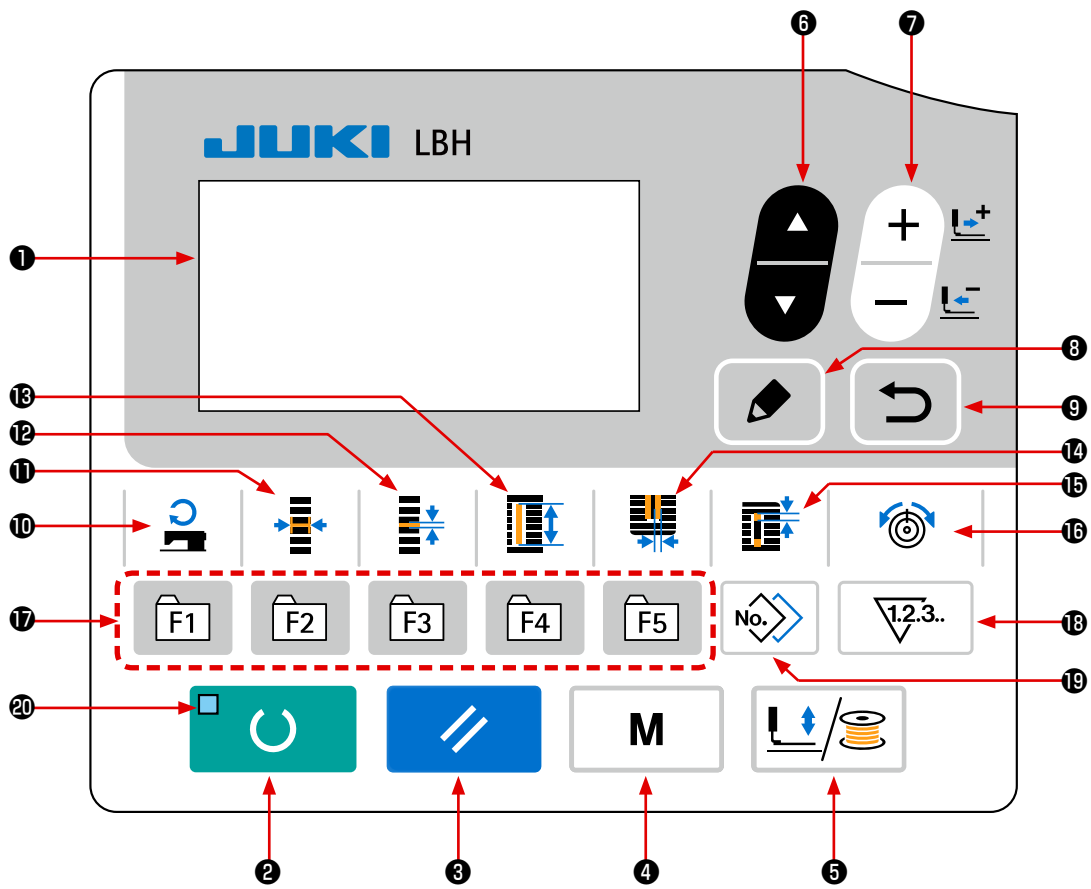







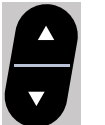

When lowering the work clamp, take care not to place your hands near the knife.

If the power is turned ON with the work clamp raised and the ready key is pressed, "E998 Work clamp deviation error" can occur.

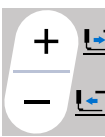
V. OPERATION OF THE SEWING MACHINE

1. Explanation of the operation panel switch



| No. | NAME | FUNCTION | No. | NAME | FUNCTION |
|-----|---|---|-----|--|--|
| ① | LCD display | Various data such as pattern No., shape, etc. are displayed. | ⑪ | OVEREDGING WIDTH key  | This key selects overedging width display. Every time this key is pressed, S005 and S006 are displayed alternately. |
| ② | READY key  | Press this key when starting sewing. Every time this key is pressed, change-over of sewing ready set state and data set state can be performed. | ⑫ | PITCH key  | This key selects pitch of parallel section. Every time this key is pressed, S007 and S021 are displayed alternately. |
| ③ | RESET key  | Press this key when releasing error, travelling the feed mechanism to its initial position, counter resetting, etc. | ⑬ | CLOTH CUT LENGTH key  | This key selects cloth cut length display. |
| ④ | MODE key  | This key is used for displaying the mode screen. | ⑭ | KNIFE GROOVE WIDTH key  | This key is used to select the knife-groove width correction display. Every time this key is pressed, S003 (right) and S004 (left) are displayed alternately. |
| ⑤ | PRESSER and WINDER key  | This key lifts or lowers the presser. When the presser goes up, the needle bar travels to the origin and when it comes down, the needle bar travels to the right. This key is pressed when performing bobbin winding. | ⑮ | CLEARANCE key  | This key selects clearance display. Every time this key is pressed, S022 (first clearance) and S023 (second clearance) are displayed alternately. |
| ⑥ | ITEM SELECT key  | This key is used to select the data No. and other kinds of data. | ⑯ | THREAD TENSION key  | This key is used to select the thread tension display. Every time this key is pressed, the display item is changed over as described below: S052 Thread tension at the right parallel section S053 Thread tension at the left parallel section (first cycle of double stitching) S054 Thread tension at the right parallel section (first cycle of double stitching) S055 Thread tension at the first bartacking section S056 Thread tension at the second bartacking section |
| ⑦ | DATA CHANGE key  | This key is used to change the pattern No. and other kinds of data. This key is used to move the feed forward on a stitch-by-stitch basis. | ⑰ | PARAMETER REGISTRATION key  | This is a short cut key that parameter registration is available. Registration of shortcut to setting display of an optional pattern, sewing parameter or adjustment data is possible. For the setting procedure, Refer to "V-16. Using parameter register key" p.45. |
| ⑧ | EDIT key  | This key is used to display the edit screen, to select the item or to display the detail screen. | ⑱ | COUNTER key  | This key selects counter display. |
| ⑨ | RETURN key  | This key is used to return the screen to the previous one. | ⑲ | COPY key  | Press this key when copying pattern. |
| ⑩ | SEWING SPEED key  | This key is used to display the parameter edit items related to the sewing speed. | ⑳ | SET READY LED | It lights up under the sewing mode. |

2. Basic operation of the sewing machine

1) Turn ON the power switch.

When you turn ON the power to the sewing machine for the first time after the purchase, the language selection screen **A** is displayed. Select the language to be displayed, then press return

key **9** .



If you terminate the language selection by pressing return key **9 without selecting the language, the language selection screen will be displayed every time you turn ON the power to the sewing machine.**

First, check that presser type **B** which has been set is the same as that of the presser actually mounted. For checking and setting procedures, refer to "**V-4. Input of the presser type**" p.25.

2) Select the pattern No. you desire to sew.

When the power is turned ON, the pattern No. **C** and pattern data name **D** are displayed.

When you want to change the pattern number,

press DATA CHANGE key **7**  and select

the number you want to use for sewing.

When you purchase the sewing machine, pattern No. 1 to 10 described in "**V-11. Changing sewing data**" p.33 have been registered. Select the pattern No. you desire to sew from among these numbers. (The No. with which the pattern has not been registered is not displayed.)

3) Set the sewing machine to sewing possible state.

When READY key **2**  is pressed, SET READY LED **20** lights up to show that the sewing is enabled.

4) Start sewing.

Set the sewing product to the presser portion, and operate the pedal to start the sewing machine, and sewing starts. The pedal type of the sewing machine has been factory-set to the 1-pedal type at the time of shipment. However, the pedal operation method can be selected from among four different ones.

Select the operating procedure you desire and use the sewing machine. → Refer to "**V-3. How to use the pedal**" p.23.

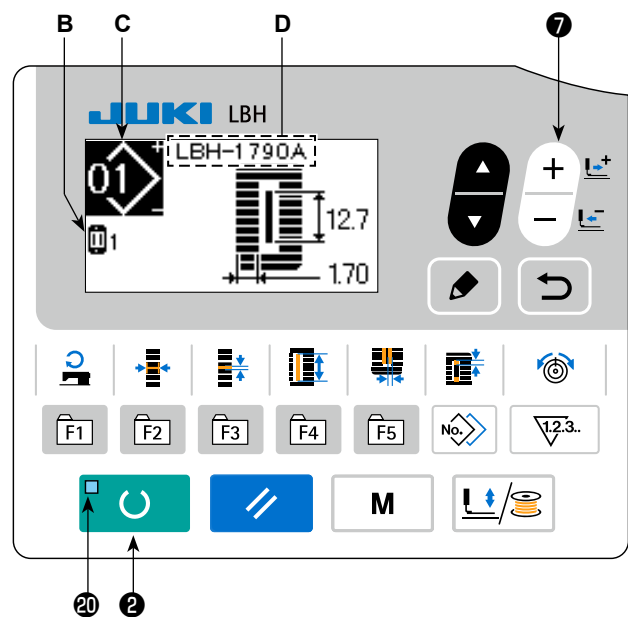
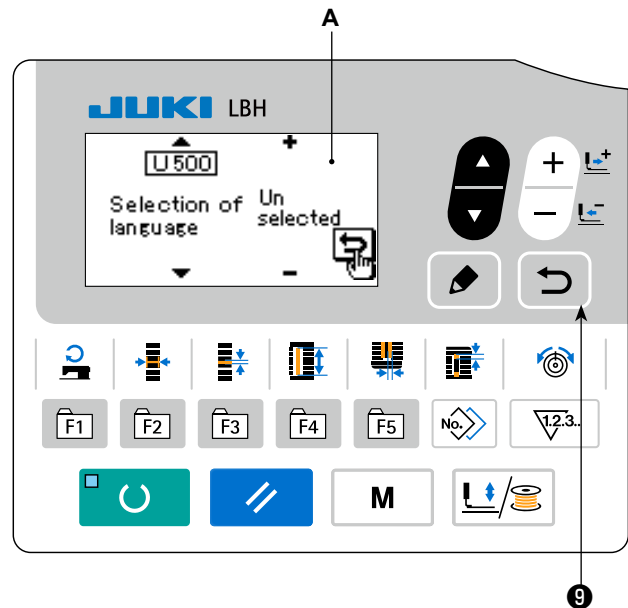



3. How to use the pedal

For this sewing machine, the pedal operation method to be used can be selected from among the four different ones as described on the next page. Select the operating procedure you desire for working efficiency and use the sewing machine.

(1) Setting procedure of the pedal type

1) Call the pedal type setting parameter.

Keep MODE key ④ **M** held pressed for three seconds under the input mode where SET READY LED ⑳ goes out. Then, the MEMORY switch (level 2) is displayed on the menu. Select the target item with ITEM SELECT key

⑥  and press EDIT key ⑧ . Then, the memory switch (level 2) edit screen **A** is displayed.

When the pedal type selection parameter **K001**

is not displayed, press ITEM SELECT key ⑥  to select the pedal type.

2) Select the pedal type.

Press DATA CHANGE key ⑦  and the picture is changed as shown in the illustration below. Select the pedal type **B** you desire.

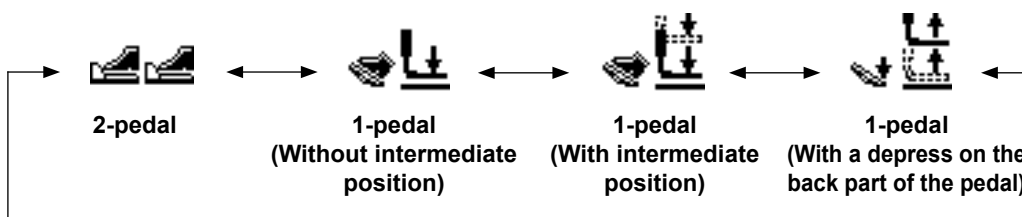
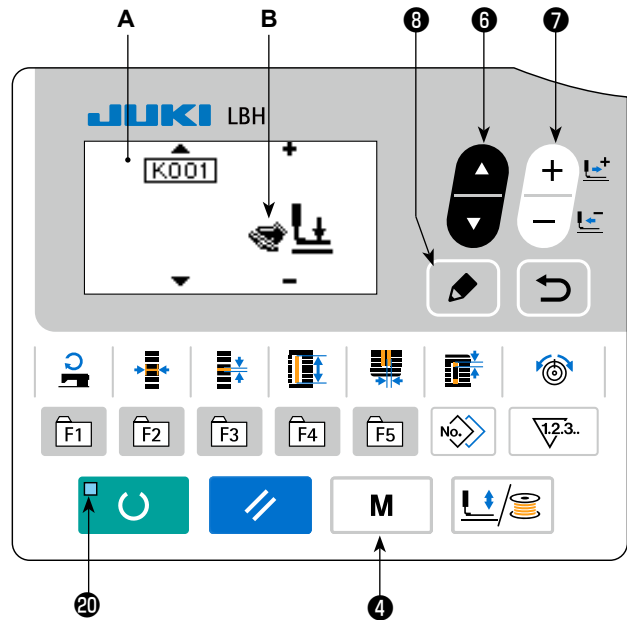

(2) Explanation of pedal motion

| <u>2-pedal type</u> | <u>1-pedal (Without intermediate position)</u> | <u>1-pedal (With intermediate position)</u> | <u>1-pedal (With a depress on the back part of the pedal)</u> |
|--|--|---|--|
| <p>Initial position Presser : <u>Intermediate position ②</u> or <u>Cloth setting position ③</u></p> <p>1) Setting of sewing product Presser goes up as high as the pedal toe down amount of the left side pedal.</p> <p>2) Start of Sewing Sewing starts when the right side pedal is depressed.</p> <p>3) End of sewing Presser automatically goes up to <u>Intermediate position ②</u> .</p> | <p>Initial position Presser : <u>Maximum position ①</u></p> <p>1) Setting of sewing product</p> <p>2) Confirmation of setting of sewing product Presser comes down to <u>Cloth setting position ③</u> when the first step of the pedal is depressed.</p> <p>3) Start of Sewing Sewing starts when the second step of the pedal is depressed.</p> <p>4) End of sewing Presser automatically goes up to <u>Maximum position ①</u> .</p> | <p>Initial position Presser : <u>Maximum position ①</u></p> <p>1) Setting of sewing product</p> <p>2) Confirmation of setting of sewing product Presser comes down to <u>Intermediate position ②</u> when the first step of the pedal is depressed.</p> <p>3) Confirmation of start of sewing Presser comes down to <u>Cloth setting position ③</u> when the second step of the pedal is depressed.</p> <p>4) Start of Sewing Sewing starts when the third step of the pedal is depressed.</p> <p>5) End of sewing Presser automatically goes up to <u>Maximum position ①</u> .</p> | <p>Initial position Presser : <u>Intermediate position ②</u></p> <p>1) Setting of sewing product</p> <p>2) Confirmation of setting of sewing product When the back part of the pedal is depressed, the presser foot goes up to <u>Maximum position ①</u> . When the pedal is depressed to the first step of its stroke, the presser foot comes down to <u>Intermediate position ②</u> . When the pedal is depressed to the second step of its stroke, the presser foot comes down to <u>Cloth setting position ③</u> .</p> <p>3) Start of Sewing Sewing starts when the third step of the pedal is depressed.</p> <p>4) End of sewing Presser automatically goes up to <u>Intermediate position ②</u> .</p> |

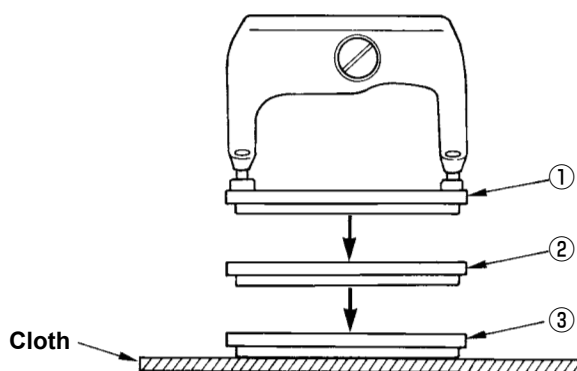

* Height of the respective positions of ① to ③ described on the left side can be set or changed by the memory switches.

→ Refer to "[V-21. Method of changing memory switch data](#)" p.53.

- Pedal switch setting (In the case the optional 2-pedal switch (part number: 40003491) is used)

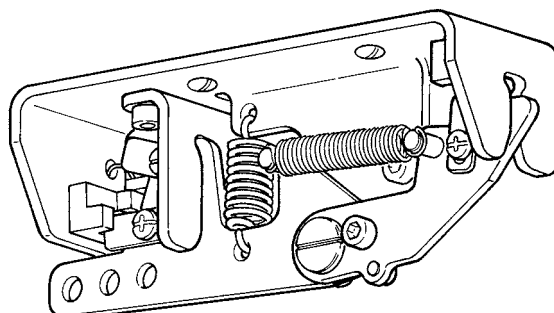

4. Input of the presser type

(1) Setting procedure of the presser type

1) Call the presser type setting parameter.

When MODE key ④ **M** is pressed, the memory switch (level 1) edit screen **A** is displayed.

2) Select the presser type.



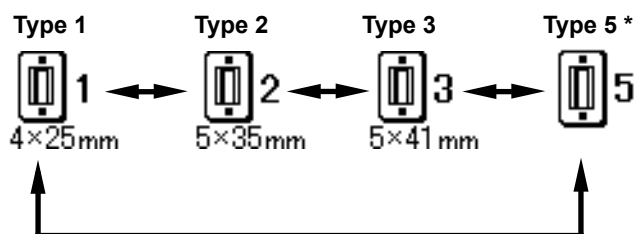
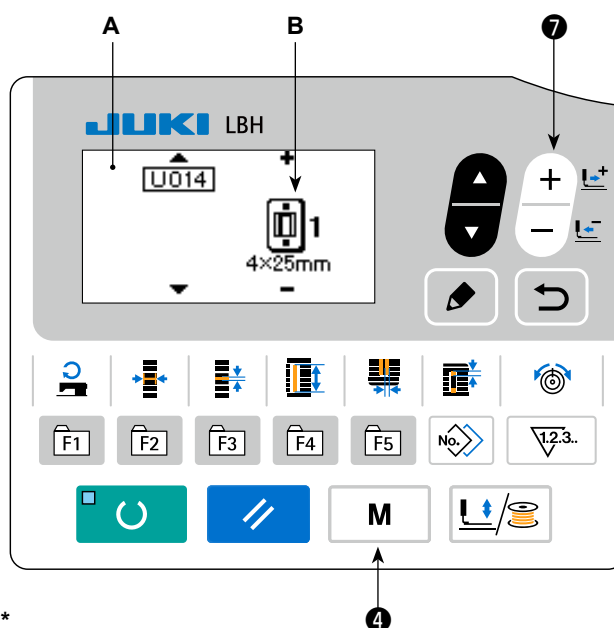

Press DATA CHANGE key ⑦ , and the

picture is changed as shown in the illustration below. Set the presser type **B** actually mounted on the sewing machine referring to (2) Table of presser type below.



(2) Table of presser type

Set the number in the frame of engraved part number of presser to the type of presser.

| | Type | Part No. of presser foot |
|---|----------|---|
|  4×25mm | Type 1 | B151177 1 000 * |
|  5×35mm | Type 2 | B151177 2 000 * |
|  5×41mm | Type 3 | B151177 3 000 * |
|  | Type 5 * | — |

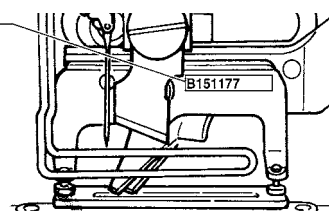

* Set type 5 when using the presser other than type 1 to 3. Change U015 Presser size width and U016 Presser size length of the memory switch (level 1) to adjust to the presser to be used.

→ Refer to "**V-21. Method of changing memory switch data**" p.53.

* When using type 5 with stitch width of 6 mm or more and 41 mm or more in length, it is necessary to replace components such as presser arm, feed plate, etc.

5. Performing pattern selection

(1) Selection from the pattern selection screen

1) Set the mode to the input mode.

Under the input mode where SET READY LED ⑳ goes out, pattern selection is enabled.

If the current mode is the sewing mode, press

READY key ㉑  to change over the mode to the input mode.

2) Call the pattern selection screen.

Pattern No. A which is currently selected is displayed.

3) Select the pattern.

Press DATA CHANGE key ㉒ , and the

patterns which have been registered are changed over in order and displayed. Here, select the No. you desire to sew.

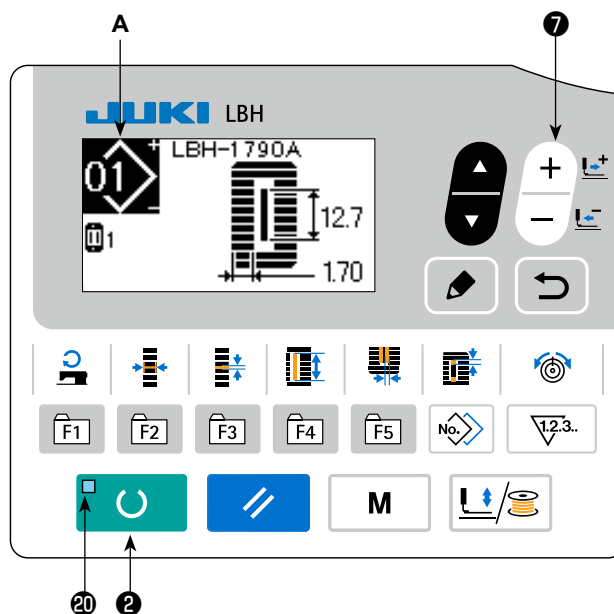

(2) Selection by means of the register key

For this sewing machine, it is possible to register a desired pattern No. to the PARAMETER REGISTER key.

When the pattern is registered once, pattern selection can be performed by pressing only the switch.

→ Refer to "[V-16. Using parameter register key](#)" p.45.

6. Changing needle thread tension

Needle thread tension can be changed while performing trial sewing since the data related to the needle thread tension can be set by the sewing mode as well.

1) Call thread tension at parallel section setting data.

When THREAD TENSION key **16**  is pressed, the sewing data edit screen **A** is displayed.

2) Change thread tension at parallel section.

Press DATA CHANGE key **7** , and set

value **B** goes up or comes down and the thread tension can be changed. The relation between the finish of sewing and the set value is as shown in the illustration below. Set the value referring to the illustration.

3) Call thread tension at bar-tacking section setting data.

When THREAD TENSION key **16**  is pressed again, the sewing data edit screen **C** is displayed.

4) Changing the needle thread tension at bar-tacking section.



Press DATA CHANGE key **7** , and set

value **D** goes up or comes down and the thread tension can be changed. The relation between the finish of sewing and the set value is as shown in table below. Set the value referring to the table.

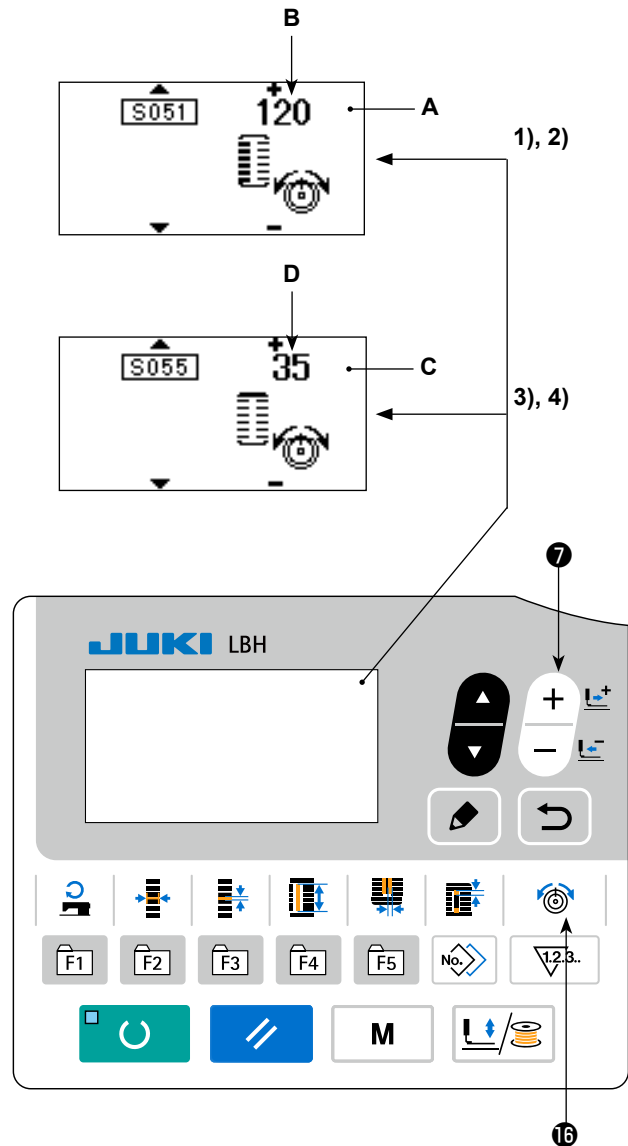
* For the tension other than that at parallel section and bar-tacking section, refer to "[V-11. Changing sewing data](#)" p.33 and "[V-21. Method of changing memory switch data](#)" p.53.



Set value of tension at ① parallel section and ② bar-tacking section

| | | Set value on panel | | |
|-------------|-------------------------------|---|---------------|---|
| | |  | Initial value |  |
| Purl stitch | ① Tension at parallel section | Crest is lowered. | 120 | Crest is raised. |
| | ② Bar-tacking tension | Thread tension is decreased. | 35 | Thread tension is increased. |
| Whip stitch | ③ Tension at parallel section | Thread tension is decreased. | 60 | Thread tension is increased. |
| | ④ Bar-tacking tension | Thread tension is decreased. | 60 | Thread tension is increased. |

For the eyelet radial shape, set the bar-tacking tension first to approximately 120 and make the balance of stitches.

Purl stitch and Whip stitch

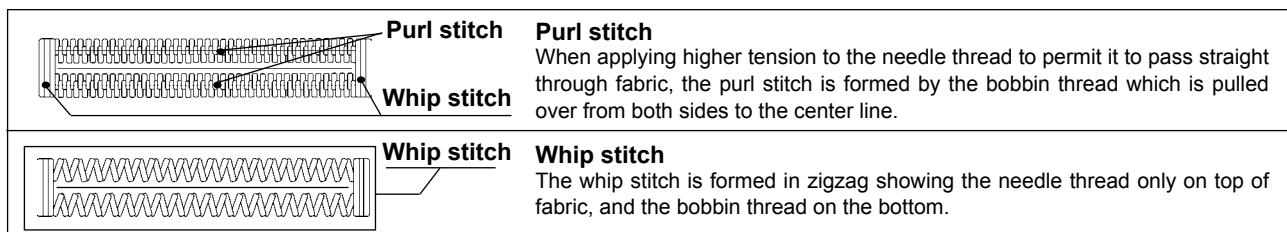

7. Performing re-sewing

When stop switch **A** is pressed during sewing operation, the sewing machine interrupts sewing and stops. At this time, error display screen **B** is displayed to inform that the stop switch is pressed.

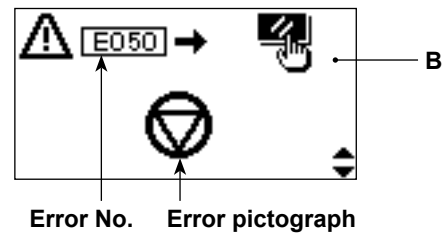
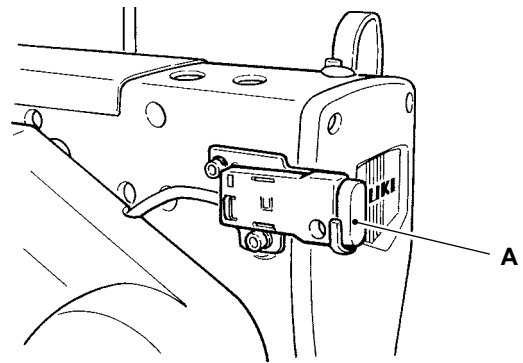

To continue performing sewing from some point in sewing

Sewing motion stop status

Error display screen **B** is displayed.

1) Release the error.

Press RESET key **3**  to release the error.

Then step motion screen **C** is displayed.

2) Return the presser.

Press BACKWARD key **7**-1  and the presser returns stitch by stitch.

Press FORWARD key **7**-2  and the presser advances stitch by stitch. Return the presser to the re-sewing position.

3) Start sewing again.

Depress the right side pedal and sewing starts again.

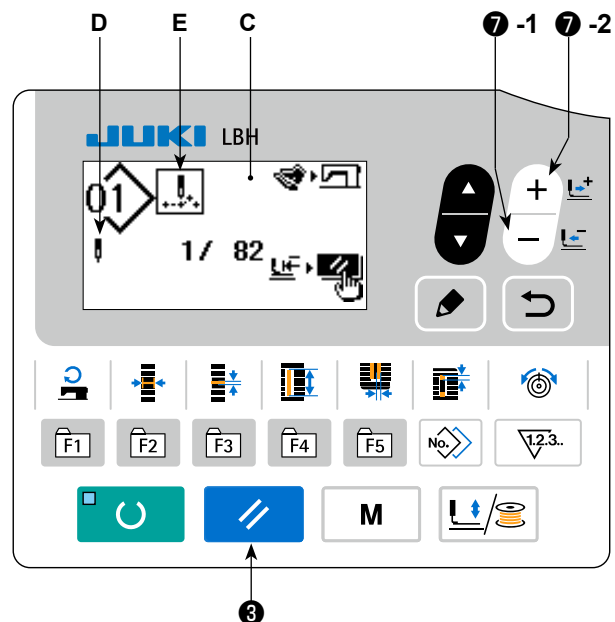

To perform re-sewing from the start

Sewing motion stop status

Error display screen **B** is displayed.

1) Release the error.

Press RESET key **3**  to release the error.

Then step motion screen **C** is displayed.

2) Return the presser to the sewing product setting position.

Press again RESET key **3**  and the presser returns to the sewing product setting position.

3) Perform again the sewing work from the start.

* Existing number of stitches/total number of stitches are displayed in section D.

* Existing sewing command is displayed in section E.

Kinds of commands are :

Sewing command



Jump feed command



Thread trimmer command



Knife command



8. Winding bobbin thread

(1) Winding the bobbin

1) Set the bobbin.

Fit a bobbin fully onto the bobbin winder shaft. Take the thread from the spool and pass it through the guides in the numerical order as shown in the figure, and wind the end of the thread several times around the bobbin. Then push the bobbin winding lever ① in the direction of the arrow mark.

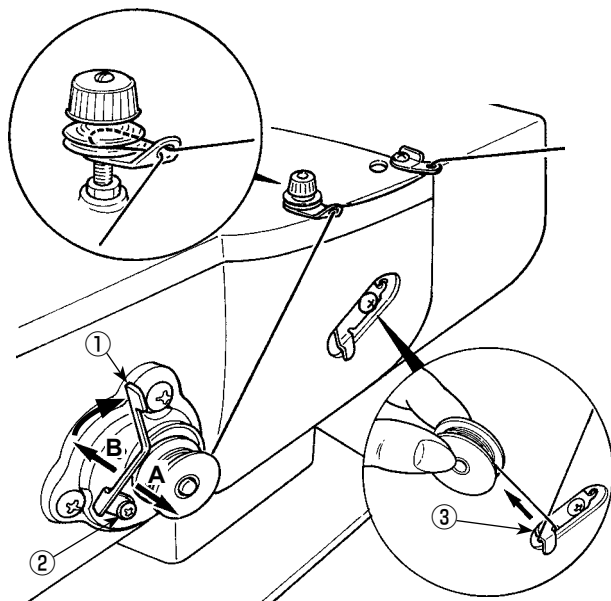

2) Set the mode to the bobbin winding mode.

Under the input state, press PRESSER and WINDER key ⑤ . In this state, press ITEM SELECT key ⑥ .

3) Start bobbin winding.

Depress the pedal, and the sewing machine rotates and starts winding bobbin thread.

4) Stop the sewing machine.

Once the bobbin is wound with the predetermined amount of thread, bobbin winding lever ① is released. Press PRESSER and WINDER key ⑤  or depress the pedal to stop the sewing machine. Then remove the bobbin and cut bobbin thread with thread trimmer retaining plate ③.

- Press PRESSER and WINDER key ⑤ , and the sewing machine stops and returns to the normal mode.
- Depress the pedal and the sewing machine stops while the bobbin thread winding mode stays as it is. Use this way when winding bobbin thread around plural bobbins.

(2) Adjusting the amount to be wound on a bobbin.

To adjust the winding amount of the bobbin thread, loosen setscrew ② and move the bobbin winding lever ① to the direction of **A** or **B**. Then, tighten setscrew ②.

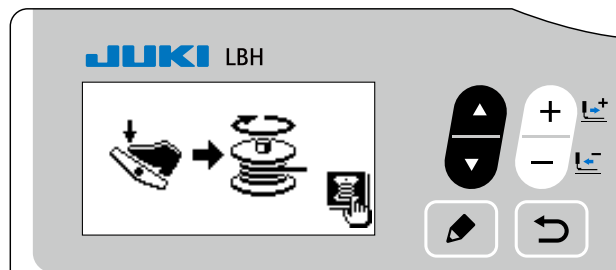
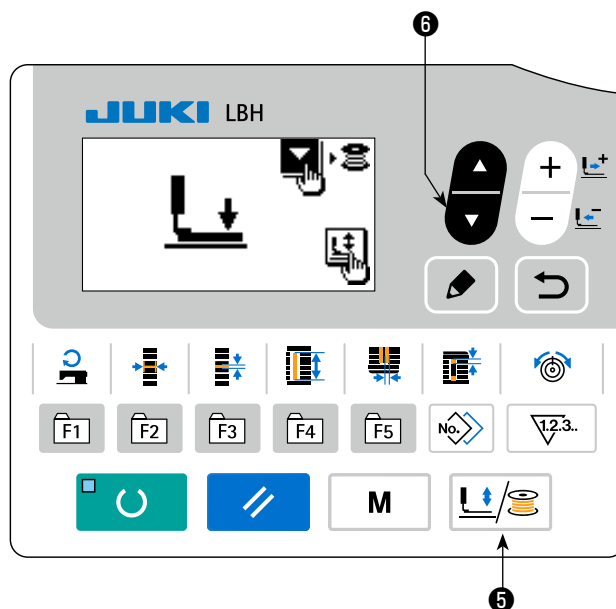

- To the direction of **A** : Decrease
- To the direction of **B** : Increase



9. Using the counter

(1) Setting procedure of the counter value

1) Call counter setting screen.

When COUNTER key ⑱  is pressed under the input mode where SET READY LED ⑳  goes out, the counter screen A is displayed to enable setting of the counter.

Setting of the counter value can be performed only with the input mode.

In case of the sewing mode, press READY key ②  to set the mode to the input mode.

 to set the mode to the input mode.

2) Selection of kinds of counters.

Press ITEM SELECT key ⑥  to display the pictograph B which indicates the counter type in reverse video.

Press DATA CHANGE key ⑦ , and select the counter you desire from among the kinds of counters below.

3) Change of counter set value.

Press ITEM SELECT key ⑥  to display the set value C of the counter in reverse video.

Press DATA CHANGE key ⑦  and input the set value until count-up is reached.

4) Change of existing counter value.

Press ITEM SELECT key ⑥  to display the current value D of the counter in reverse video.

Press RESET key ③  and the value on the way of counting can be cleared.

In addition, it is possible to edit the numerical value with DATA CHANGE key ⑦ .

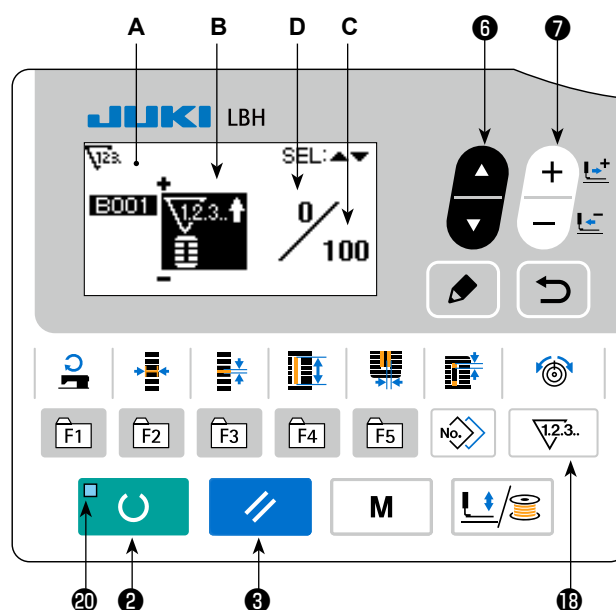

The counter has been factory-set to "① Sewing UP counter" at the time of delivery. This counter has been factory-set so that it stops counting after the number of times of start of sewing machine has reached 100. Set this counter according to your conditions of use.

(2) Kind of counter



① Sewing UP counter

Every time the sewing of one shape is performed, the existing value is counted up. When the existing value is equal to the set value, count-up screen is displayed.



② Sewing DOWN counter

Every time the sewing of one shape is performed, the existing value is counted down. When the existing value is reached to "0", count-up screen is displayed.



③ No. of pcs. UP counter

Every time one cycle or one continuous stitching is performed, the existing value is counted up. When the existing value is equal to the set value, count-up screen is displayed.



④ No. of pcs. DOWN counter

Every time one cycle or one continuous stitching is performed, the existing value is counted down. When the existing value is reached to "0", count-up screen is displayed.



⑤ Counter not used

(3) Count-up releasing procedure

When count-up condition is reached during sewing work, the whole count-up screen **E** flashes on and off. Press RESET key  to reset the counter, and the mode returns to the sewing mode. Then the counter starts counting again.

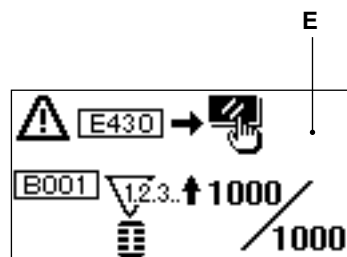

10. Using the initial value pattern

This sewing machine has the initial value to perform the optimum sewing for the sewing shapes (31 shapes).

→ Refer to **"XI. INITIAL VALUE DATA FOR EACH SHAPE TABLE" p.80**.

When creating sewing data newly, it is convenient to create it by copying the initial value pattern.

1) Set the mode to the input mode.

Under the input mode where SET READY LED ⑳ goes out, pattern change is enabled. If the current mode is the sewing mode, press READY key ㉑

 to change over the mode to the input mode.

2) Call initial value pattern.

The currently-selected pattern No. **A** is displayed.

Press DATA CHANGE key ㉑  to select

initial value pattern .

3) Select shape.

The shape selection screen **B** is displayed to shown the currently-selected shape **C**.

Select shape **C** to sew with DATA CHANGE key

㉑ . It is possible to select the shape from

among 12 shapes at the time of your purchase.

However, it is possible to select the shape from

among maximum 31 shapes by increasing the shape selection level (K004).

→ Refer to **"V-21. Method of changing memory switch data" p.53**.

4) Perform trial sewing.

Press READY key ㉑  to set the mode to the sewing mode. Then it is possible to perform sewing and the selected shape can be sewn.

* The initial-value pattern can be edited only with respect to the data on needle thread tension and sewing speed. Be aware that the edited data will return to the initial value(s) when the pattern shape is changed or re-call of the pattern is carried out.

5) Copy initial value pattern.

Copy the pattern which has been selected and confirmed through the steps above to the normal pattern and use it.

Copying procedure → Refer to **"V-14. Copying sewing pattern" p.42**.

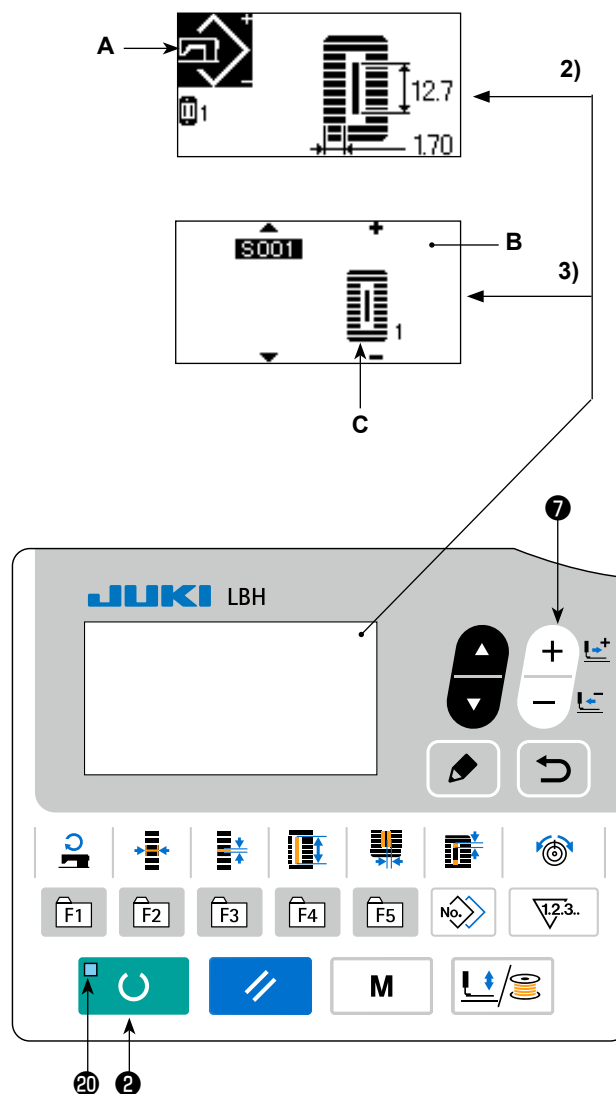

11. Changing sewing data

(1) Initial sewing data at the time of your purchase

Patterns from 1 to 10 have been already registered at the time of your purchase. Initial values of the square type, the cloth cutting length of which only is different from each other, have been inputted in the sewing data. → Refer to **"XI. INITIAL VALUE DATA FOR EACH SHAPE TABLE" p.80.**

| Pattern No. | Cloth cutting length  | S002 |
|-------------|--|------|
| 1 | 6.4 mm (1/4") | |
| 2 | 9.5 mm (3/8") | |
| 3 | 11.1 mm (7/16") | |
| 4 | 12.7 mm (1/2") | |
| 5 | 14.3 mm (9/16") | |
| 6 | 15.9 mm (5/8") | |
| 7 | 17.5 mm (11/16") | |
| 8 | 19.1 mm (3/4") | |
| 9 | 22.2 mm (7/8") | |
| 10 | 25.4 mm (1") | |

(2) Changing procedure of sewing data

1) Set the mode to the input mode.

Under the input mode where SET READY LED  goes out, sewing-data change is enabled.

If the current mode is the sewing mode, press

READY key  to change over the mode to the input mode.

2) Call sewing data edit screen.

When EDIT key  is pressed, the sewing data edit screen **A** for the currently-selected pattern No. is displayed.

3) Select sewing data to be changed.

Press ITEM SELECT key , and select the

data item you desire to change.

Data item which is not used according to the shape and data item which is set without function are skipped and not displayed. So, be careful.

→ Refer to **"V-12. Method of setting sewing data with/without edit" p.35.**

4) Change data.

For the sewing data, there are data item which changes numerical value and that which selects pictograph. No. such as **S002** is attached to the data item which changes numerical value. Increase or decrease the

set value with DATA CHANGE key  to change the value.

No. such as **S001** is attached to the data item which selects pictograph. Pictograph can be selected with

DATA CHANGE key .

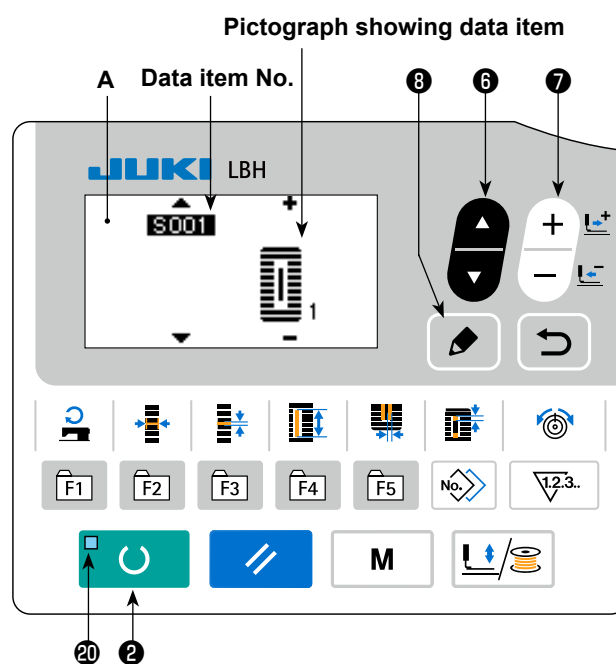

→ For the details of sewing data, refer to **"V-13. Sewing data list" p.36.**



5) Changing the name of pattern data.

Select "S500 Pattern data name" and press EDIT key ⑧  to enable change of the pattern data name.

When you press ITEM SELECT key ⑥ , the edit point will move in sequence. The character placed between "+" and "-" is the edit position under selection.

Press DATA CHANGE key ⑦  while the character is being selected, the character can be selected. Press RESET key ③  to delete the character which is being selected. When you keep RESET key ③  held pressed for one second, the data name can be deleted. Change the pattern data name by carrying out the aforementioned procedure in repetition.

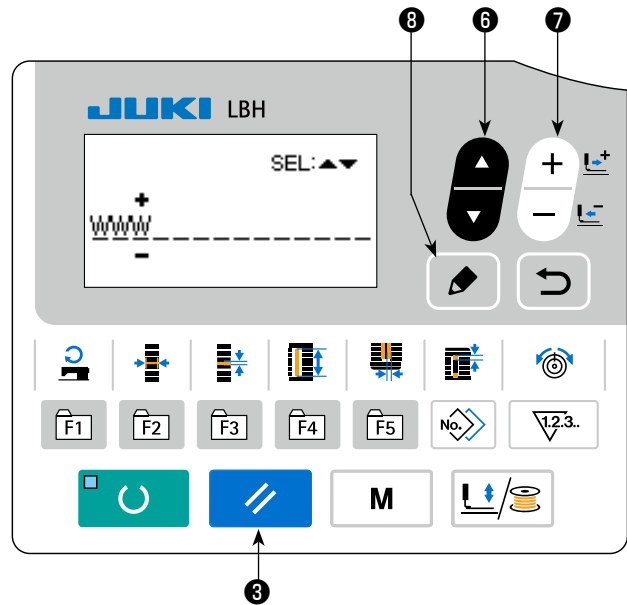

The characters that can be used for the pattern name

A - Z, 0 - 9, ., +, -, /, #, (blank)

12. Method of setting sewing data with/without edit

This sewing machine has been set so as not to be capable of editing sewing data items which are less frequently used at the time of your purchase. When you desire to set the data more closely in accordance with the sewing products, set the sewing data item to the edit possible state and use the machine.

* For the setting of sewing data with/without edit, when S052, right parallel section tension is set to without edit, sewing is performed with the data of S051 left parallel section tension. When S056, 2nd bar-tacking tension is set to without edit, sewing is performed with the data of S055, 1st bar-tacking section.

When the sewing data items other than the above ones are set to without edit, the data to be referred are the initial value data.

1) Set the mode to the input mode.

Under the input mode where SET READY LED  goes out, data setting is enabled.

If the current mode is the sewing mode, press

READY key  to change over the mode to the input mode.

2) Call sewing data with/without edit changeover screen.

Press MODE key . Select "05

Sewing parameter edit select". Then, data edit enable/disable changeover screens **A** and **B** are displayed.

3) Select sewing data you desire to change over.

Press ITEM SELECT key , and select

sewing data item **C** you desire to change over. At this time, changeover possible item only can be selected.

4) Changeover of with/without edit.

When DATA CHANGE key  is pressed,

the pictograph display **C** for the currently-selected sewing data is changed over.

Non-reverse display : With edit

Reverse display : Without edit

Return to step 3), and plural sewing data items can be changed over.

5) Save data which have been set.

When RETURN key  is pressed, the





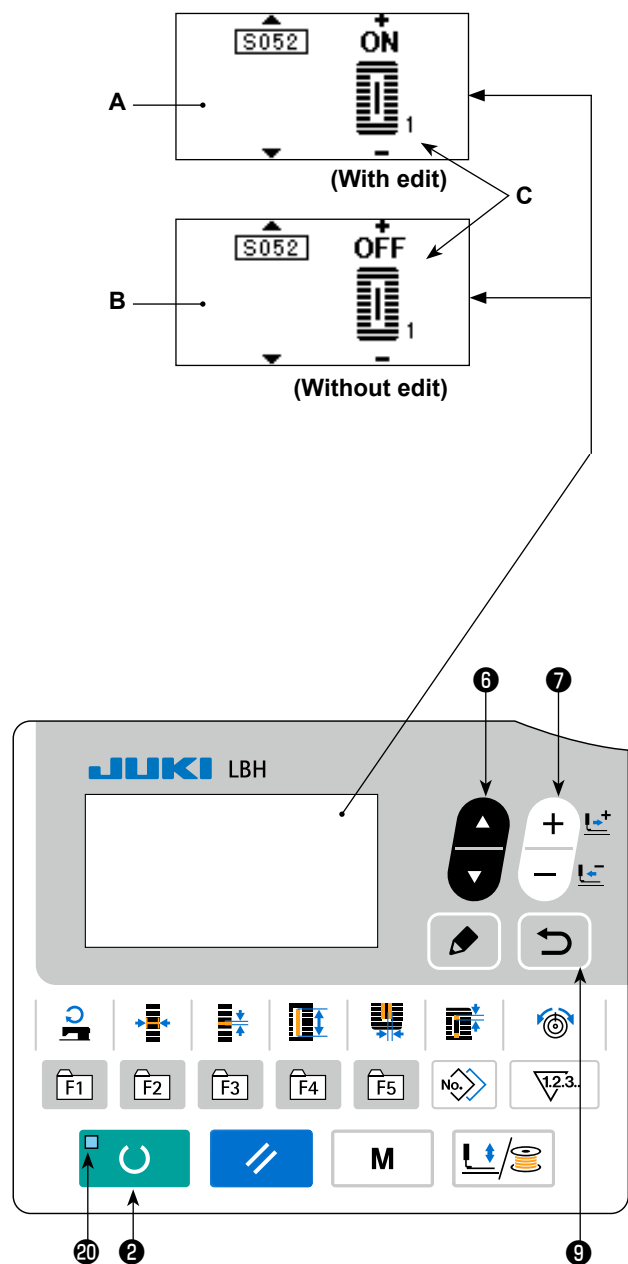







changed-over state is saved and the screen returns to the mode screen. When RESET key

























 is pressed, the screen returns to the previous screen.



13. Sewing data list

☆ Sewing data are those that can be inputted to 99 patterns from pattern 1 to 99 and can be inputted to each pattern. The sewing machine has been set in the state that the data which is necessary to set "With/without edit" cannot be selected at the time of your purchase. Change over the function to "With edit" if necessary for the use. → Refer to "**V-12. Method of setting sewing data with/without edit**" p.35.









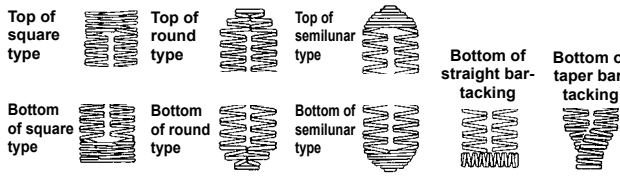

| No. | Item | Setting range | Edit unit | Remarks |
|------|--|----------------|-----------|---------|
| S001 | <p>Sewing shape Select a desired pattern shape from among 31 sewing shapes stored in the sewing machine.</p>  <p>Refer to "II-2. Standard sewing shape list" p.3.</p> <p>* Only 12 kinds of standard sewing shapes can be selected at the time of your purchase. When increasing the kinds of shapes, perform setting of K004 Sewing shape selection level of memory switch data. → Refer to "V-22. Memory switch data list" p.54.</p> | 1 to 31 | 1 | — |
| S002 | <p>Cloth cut length This item sets the length of cloth that is cut by cloth cutting knife. However, in case of bar-tack shape (Nos. 27, 28, 29, and 30 of S001), sewing length is set. By making effective U019 Function of plural motions of cloth cutting knife of memory switch data, make the plural motions of knife by the knife size set in the item U018 Cloth cutting knife size, and the sewing product is cut. → Refer to "V-22. Memory switch data list" p.54.</p>  | 3.0 to 120.0 | 0.1 mm | — |
| S003 | <p>Knife groove width, right This item sets the clearance between cloth cutting knife and right parallel section.</p>  | -2.00 to 2.00 | 0.05 mm | — |
| S004 | <p>Knife groove width, left This item sets the clearance between cloth cutting knife and left parallel section.</p>  | -2.00 to 2.00 | 0.05 mm | — |
| S005 | <p>Overedging width, left This item sets the overedging width of left parallel section.</p>  | 0.10 to 5.00 | 0.05 mm | — |
| S006 | <p>Ratio of right and left shapes This item sets enlargement/reduction ratio of right side shape making the knife position as the center.</p>  | 50 to 150 | 1% | — |
| S007 | <p>Pitch at parallel section This item sets sewing pitch of left and right parallel sections.</p>  | 0.200 to 2.500 | 0.025 mm | — |
| S008 | <p>2nd bar-tacking length This item sets length of bar-tacking on the front side.</p> <p>Bottom of square type  Bottom of straight bar-tacking  Bottom of taper </p>  | 0.2 to 5.0 | 0.1 mm | — |
| S009 | <p>1st bar-tacking length This item sets length of bar-tacking on the rear side.</p> <p>Top of square type </p>  | 0.2 to 5.0 | 0.1 mm | — |

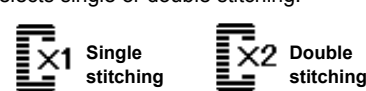
| No. | Item | Setting range | Edit unit | Remarks |
|------|---|---------------|-----------|---------|
| S010 | <p>Compensation of bar-tacking width, right This item adjusts right side outer shape of bar-tacking section in terms of overedging section. It is corrected 1st and 2nd bar-tacking together.</p> <p>Top of square type  Bottom of square type  Bottom of straight bar-tacking </p>  | -1.00 to 1.00 | 0.05 mm | – |
| S011 | <p>Compensation of bar-tacking width, left This item adjusts left side outer shape of bar-tacking section in terms of overedging section.</p> <p>Top of square type  Bottom of square type  Bottom of straight bar-tacking </p>  | -1.00 to 1.00 | 0.05 mm | – |
| S012 | <p>Taper bar-tacking offset, left This item sets length to form bar-tacking section of taper bar-tacking shape.</p>  | 0.00 to 3.00 | 0.05 mm | *1 |
| S013 | <p>Taper bar-tacking offset, right This item sets length to form bar-tacking section of taper bar-tacking shape.</p>  | 0.00 to 3.00 | 0.05 mm | *1 |
| S014 | <p>Eyelet shape length This item sets upper side length from center of eyelet of eyelet shape.</p>  | 1.0 to 10.0 | 0.1 mm | *1 |
| S015 | <p>Number of stitches of eyelet shape This item sets number of stitches in the upper 90° of eyelet shape.</p>  | 1 to 8 | 1 | *1 |
| S016 | <p>Eyelet width This item sets crosswise size of the inside of eyelet shape. Actual needle entry point is the dimension to which S004 Knife groove width, left is added.</p>  | 1.0 to 10.0 | 0.1 mm | *1 |
| S017 | <p>Eyelet length This item sets lengthwise size of the inside of eyelet shape.</p>  | 1.0 to 10.0 | 0.1 mm | *1 |
| S018 | <p>Round type shape length This item sets upper length from the center of round type shape.</p> <p>Top of round type  Top of Radial type  Top of semilunar type </p> <p>Bottom of round type  Bottom of radial type  Bottom of semilunar type </p>  | 1.0 to 5.0 | 0.1 mm | *1 |
| S019 | <p>Number of stitches of radial shape This item sets number of stitches in the upper 90° of radial shape.</p>  | 1 to 8 | 1 | *1 |
| S020 | <p>Reinforcement of radial shape This item sets with/without reinforcement stitching of radial shape.</p> <p> : With  : Without</p> | – | – | *1, *2 |

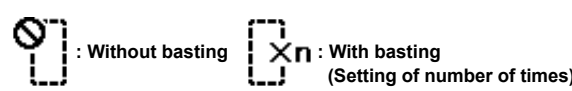
*1 : Displayed according to the shape

*2 : Displayed when it is set to with edit. Refer to "V-12. Method of setting sewing data with/without edit" p.35.













*3 : Displayed when the function is selected.

| No. | Item | Setting range | Edit unit | Remarks |
|------|--|----------------|-----------|---------|
| S021 | <p>Pitch at bar-tacking section This item sets sewing pitch of bar-tacking section.</p>  <p>Top of square type, Top of round type, Top of semilunar type, Bottom of square type, Bottom of round type, Bottom of semilunar type, Bottom of straight bar-tacking, Bottom of taper bar-tacking</p> | 0.200 to 2.500 | 0.025 mm | — |
| S022 | <p>1st clearance This item sets the clearance between 1st bar-tacking and knife groove. This item is applied to all shapes.</p>  | 0.0 to 4.0 | 0.1 mm | — |
| S023 | <p>2nd clearance This item sets the clearance between 2nd bar-tacking and knife groove. This item is applied to all shapes.</p>  | 0.0 to 4.0 | 0.1 mm | — |
| S031 | <p>Single/double stitching This item selects single or double stitching.</p>  <p>X1 Single stitching, X2 Double stitching</p> | — | — | — |
| S032 | <p>Double stitching cross selection This item selects overlapping stitching or cross stitching at the needle entry of parallel section when setting double stitching.</p>  <p>: Double stitching, : Cross stitching</p> | — | — | *3 |
| S033 | <p>Compensation of double stitching width This item sets amount to narrow overedging width of 1st cycle when setting double stitching.</p>  | 0.0 to 2.0 | 0.1 mm | *3 |
| S034 | <p>Number of times of basting This item sets number of times of basting.</p>  <p>: Without basting, Xn : With basting (Setting of number of times)</p> | 0 to 9 | 1 time | — |
| S035 | <p>Basting pitch This item sets pitch at the time of performing basting.</p>  | 1.0 to 5.0 | 0.1 mm | *3 |
| S036 | <p>Rolling length of basting This item sets rolling length of needle thread when performing basting.</p>  | 2.0 to 20.0 | 0.1 mm | *3 |
| S037 | <p>Rolling pitch of basting This item sets rolling pitch of needle thread when performing basting.</p>  | 0.2 to 5.0 | 0.1 mm | *3 |
| S038 | <p>Rolling width of basting This item sets rolling width of needle thread when performing basting.</p>  | 0.0 to 4.0 | 0.1 mm | *3 |
| S039 | <p>Lengthwise compensation of needle entry of basting This item sets the amount to move needle entry position back and forth when performing basting more than two cycles.</p>  | 0.0 to 2.5 | 0.1 mm | *2, *3 |

*1 : Displayed according to the shape

*2 : Displayed when it is set to with edit. Refer to "V-12. Method of setting sewing data with/without edit" p.35.















*3 : Displayed when the function is selected.

| No. | Item | Setting range | Edit unit | Remarks |
|------|--|---------------|-------------|---------|
| S040 | Crosswise compensation of needle entry of basting This item sets the amount to move needle entry position to the right or left when performing basting more than two cycles.  | 0.0 to 1.0 | 0.1 mm | *3 |
| S041 | Compensation of left side position of basting This item sets the amount to move the sewing reference position of basting from the center of left overedging to the right or left.  | -2.0 to 2.0 | 0.1 mm | *2, *3 |
| S042 | Compensation of right side position of basting This item sets the amount to move the sewing reference position of basting from the center of right overedging to the right or left.  | -2.0 to 2.0 | 0.1 mm | *2, *3 |
| S044 | Speed setting of basting This item sets speed of basting.  | 400 to 4200 | 100 sti/min | *3 |
| S051 | Left parallel section tension This item sets needle thread tension at left parallel section.  | 0 to 200 | 1 | – |
| S052 | Right parallel section tension This item sets needle thread tension at right parallel section.  | 0 to 200 | 1 | *2 |
| S053 | Left parallel section tension (1st cycle of double stitching) This item sets needle thread tension at left parallel section of 1st cycle at the time of double stitching.  | 0 to 200 | 1 | *2, *3 |
| S054 | Right parallel section tension (1st cycle of double stitching) This item sets needle thread tension at right parallel section of 1st cycle at the time of double stitching.  | 0 to 200 | 1 | *2, *3 |
| S055 | Tension at 1st bar-tacking section This item sets needle thread tension at 1st bar-tacking section.  | 0 to 200 | 1 | – |
| S056 | Tension at 2nd bar-tacking section This item sets needle thread tension at 2nd bar-tacking section.  | 0 to 200 | 1 | *2 |
| S057 | Setting of needle thread tension at the start of sewing This item sets needle thread tension of tie stitching at the start of sewing.  | 0 to 200 | 1 | – |
| S058 | Setting of needle thread tension of basting This item sets needle thread tension of basting.  | 0 to 200 | 1 | *3 |
| S059 | ACT timing adjustment at the start of 1st bar-tacking This item adjusts needle thread tension output start timing at 1st bar-tacking section.  | -5 to 5 | 1 stitch | *2 |

*1 : Displayed according to the shape

*2 : Displayed when it is set to with edit. Refer to "V-12. Method of setting sewing data with/without edit" p.35.







*3 : Displayed when the function is selected.

| No. | Item | Setting range | Edit unit | Remarks |
|------|---|---------------|-----------|---------|
| S060 | ACT timing adjustment at the start of right overedging This item adjusts needle thread tension output start timing at right overedging section.  | -5 to 5 | 1 stitch | *2 |
| S061 | ACT timing adjustment at the start of 2nd bar-tacking This item adjusts needle thread tension output start timing at 2nd bar-tacking section.  | -5 to 5 | 1 stitch | *2 |
| S062 | Number of stitches of tie stitching at the start of sewing This item sets number of stitches of tie stitching at the start of sewing.  | 0 to 8 | 1 stitch | - |
| S063 | Sewing pitch of tie stitching at the start of sewing This item sets sewing pitch of tie stitching at the start of sewing.  | 0.00 to 0.70 | 0.05 mm | *2 |
| S064 | Tie stitching width at the start of sewing This item sets tie stitching width at the start of sewing.  | 0.0 to 3.0 | 0.1 mm | - |
| S065 | Lengthwise compensation of tie stitching at the start of sewing This item sets start position of tie stitching in lengthwise direction at the start of sewing.  | 0.0 to 5.0 | 0.1 mm | *2 |
| S066 | Crosswise compensation of tie stitching at the start of sewing This item sets start position of tie stitching in crosswise direction at the start of sewing.  | 0.0 to 2.0 | 0.1 mm | *2 |
| S067 | Tie stitching width at the end of sewing This item sets tie stitching width at the end of sewing.  | 0.1 to 1.5 | 0.1 mm | - |
| S068 | Number of stitches of tie stitching at the end of sewing This item sets number of stitches of tie stitching at the end of sewing.  | 0 to 8 | 1 | - |
| S069 | Lengthwise compensation of tie stitching at the end of sewing This item sets start position of tie stitching in lengthwise direction at the end of sewing.  | 0.0 to 5.0 | 0.1 mm | *2 |
| S070 | Crosswise compensation of tie stitching at the end of sewing This item sets start position of tie stitching in crosswise direction at the end of sewing.  | 0.0 to 2.0 | 0.1 mm | *2 |
| S081 | Knife motion This item sets "With/without motion" of normal cloth cutting knife.  : Normal knife motion OFF  : Normal knife motion ON | - | - | - |
| S083 | Knife motion at 1st cycle of double stitching This item sets "With/without motion" of cloth cutting knife at 1st cycle when double stitching is performed.  : Normal knife motion OFF  : Normal knife motion ON | - | - | *2, *3 |

*1 : Displayed according to the shape

*2 : Displayed when it is set to with edit. Refer to "V-12. Method of setting sewing data with/without edit" p.35.

*3 : Displayed when the function is selected.

| No. | Item | Setting range | Edit unit | Remarks |
|------|---|----------------|-------------|---------|
| S084 | <p>Maximum speed limitation</p> <p>This item sets max. speed limitation of the sewing machine. The maximum value of data edit is equal to the number of revolutions of K007 Maximum speed limitation of the memory switch data. → Refer to "V-22. Memory switch data list" p.54.</p>  | 400 to 4200 | 100 sti/min | – |
| S086 | <p>Pitch of going</p> <p>This item sets sewing pitch of going side of bar-tacking shape (Shape Nos. 27, 28, 29 and 30 of S001).</p>  | 0.200 to 2.500 | 0.025 mm | – |
| S087 | <p>Width of going</p> <p>This item sets width of going side of bar-tacking shape (Shape Nos. 27, 28, 29 and 30 of S001).</p>  | 0.1 to 10.0 | 0.05 mm | – |
| S088 | <p>Pitch of coming</p> <p>This item sets sewing pitch of coming side of bar-tacking shape (Shape Nos. 27, 28, 29 and 30 of S001).</p>  | 0.200 to 2.500 | 0.025 mm | – |
| S089 | <p>Width of coming</p> <p>This item sets width of coming side of bar-tacking shape (Shape Nos. 27, 28, 29 and 30 of S001).</p>  | 0.1 to 10.0 | 0.05 mm | – |
| S090 | <p>Presser foot pressure</p> <p>Used to set the pressure to clamp the material. When the set value is 25, the presser foot pressure is approximately 4 kg. When the set value is 80, the presser foot pressure is approximately 10 kg.</p>  | 20 to 80 | 1 | – |
| S500 | <p>Pattern data name</p> <p>Used for changing the name of pattern data.</p> | – | – | – |

14. Copying sewing pattern

Data of pattern No. which has been already registered can be copied to pattern No. which has not been used. Overwriting copy of the pattern is prohibited. When you desire to overwrite, perform it after erasing the pattern once.

1) Set the mode to input mode.

Under the input mode where SET READY LED ⑳ goes out, copy is enabled.

If the current mode is the sewing mode, press

READY key ②  to change over the mode to the input mode.

2) Select pattern No. of copy source.

Press ITEM SELECT key ⑥  to select the source pattern No.

→ Refer to "[V-5. Performing pattern selection](#)" p.26

When creating pattern data quite newly, it is convenient to copy the initial value pattern.

→ Refer to "[V-10. Using the initial value pattern](#)" p.32

3) Call copy screen.

Press COPY key ⑲ , and copy screen A is displayed.

4) Select pattern No. of copy destination.

Pattern No. B which is not used is displayed.

Press DATA CHANGE key ⑦  to select a

number to be used for copying. When you desire to erase the pattern, select the garbage can .

5) Start copying.

When READY key ②  is pressed, the copy starts. Then, the screen returns to the input screen on which the pattern No. which is created by copying is selected.

When RETURN key ⑨  is pressed, the screen returns to the previous screen without performing copying.

* In addition, cycle data and continuous stitching data can be copied by the same method.

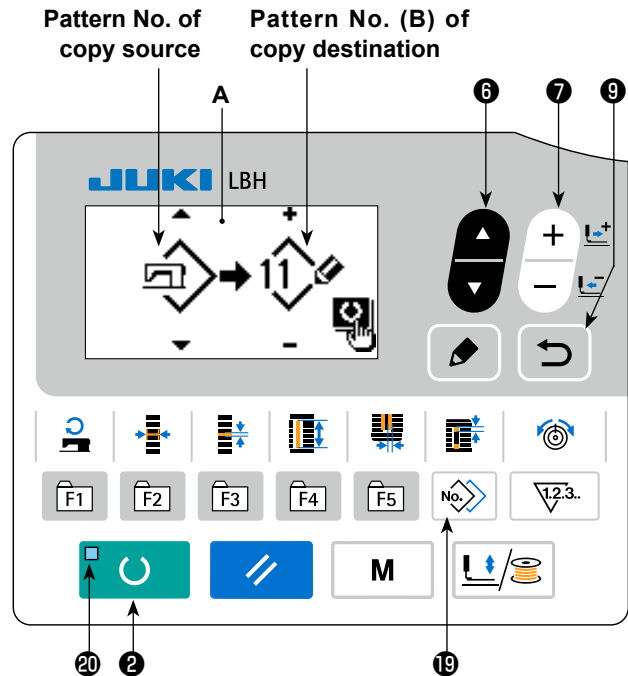

15. How to edit/check the data other than sewing data

The screen for editing/checking the various data is invoked by selecting the menu on the mode screen.

1) Set the mode to input mode.

Under the input mode where set ready LED ⑳ goes out, the mode screen can be called. If the current mode is the sewing mode, press READY key ②  to change over the mode to the input mode.

2) How to invoke the mode screen.

Press MODE key ④  to display the mode screen (operator level).

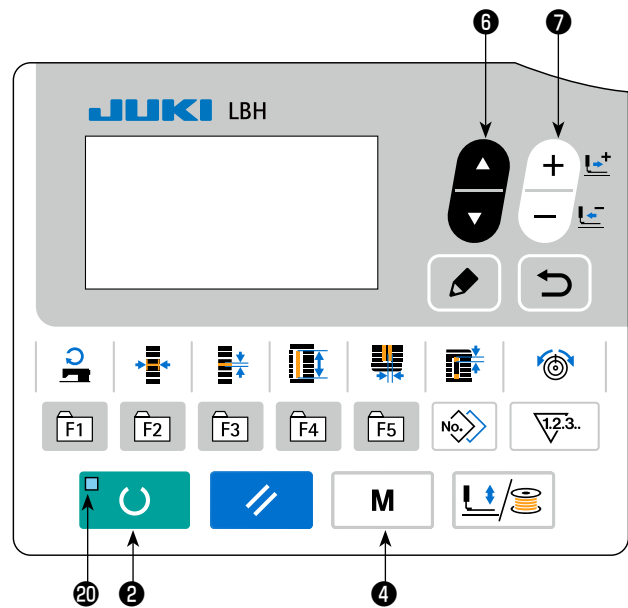

Then, keep MODE key ④  held pressed for three seconds to display the mode screen (service level).

On each level mode screen, the menu items listed in the table below are displayed.



| Display level | Menu on the mode screen |
|-----------------------------|---|
| Operator level | Memory switch 1 Version display Communication Regist. of parmtr key Sewing parameter edit selection |
| Maintenance personnel level | USB format Check program Pedal VR adjustment Adjustment of contrast Memory switch 2 Key lock |

3) Selecting the menu.

Items which can be registered on the key are displayed. Press ITEM SELECT key  to select the target menu. When you press EDIT key  during the menu selection, the following screens can be invoked.

1. **Memory switch 1**
→ Refer to "[V-21. Method of changing memory switch data](#)" p.53 for details.
2. **Version display**
Version of the system software is displayed.
3. **Communication**
→ Refer to "[V-27. Communication](#)" p.61 for details.
4. **Regist. of parmtr key**
→ Refer to "[V-16. Using parameter register key](#)" p.45 for details.
5. **Sewing parameter edit selection**
→ Refer to "[V-12. Method of setting sewing data with/without edit](#)" p.35 for details.
6. **USB format**
→ Refer to the Engineer's Manual for details.
7. **Check parogram**
→ Refer to the Engineer's Manual for details.
8. **Pedal VR adjustment**
→ Refer to "[V-24. How to adjust the pedal variable resistor](#)" p.59 for details.
9. **Adjustment of contrast**
→ Refer to "[V-25. How to adjust the contrast](#)" p.60 for details.
10. **Memory switch 2**
→ Refer to "[V-22. Memory switch data list](#)" p.54 for details.
11. **Key lock**
→ Refer to the Engineer's Manual for how to enable selection of the key lock from the mode screen and how to set the key lock.



For the functions which are not described in this manual, only the maintenance personnel is allowed to operate while referring to the Engineer's Manual since operating those functions can lock up the sewing machine or can cause unforeseen accidents.

16. Using parameter register key

Register parameters which are frequently used with parameter register key and use them.

Parameters which have been registered can be selected by pressing only the parameter register key under the input mode.

(1) Method of register

1) Set the mode to the input mode.

Under the input mode where SET READY LED ⑳ goes out, parameter registration is enabled.

If the current mode is the sewing mode, press

READY key ②  to change over the mode to the input mode.

2) Call parameter register screen.

Press MODE key ④  to display the mode screen. Select the parameter key registration on this screen. Then, the parameter registration screen **A** is displayed.

When you press EDIT key ⑧  on the screen, the parameter registration key setting screen is displayed.

The parameter registration key setting screen can also be displayed by keeping the parameter registration key you want to edit held pressed.

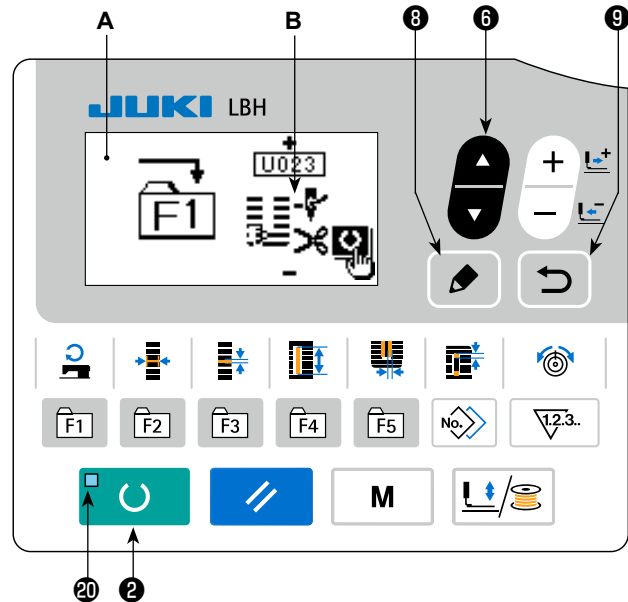

3) Select parameter.

Item **B** which can be registered to the key is displayed. Press ITEM SELECT key ⑥  to select the item to be registered.





Items which can be registered are sewing data, parameters of memory switches (level 1) and pattern Nos. In addition, when trash can  is selected, register can be released.

4) Start register.

When READY key ②  is pressed, registration starts, and the screen returns to the mode screen.

When RETURN key ⑨  is pressed, the screen returns to the previous screen without performing registration.

(2) Register status at the time of your purchase

| Register key | Registered parameter |
|--------------|---|
| F1 | Changeover of single/double stitching  S031 |
| F2 | Basting (off/number of times)  S034 |
| F3 | Basting needle thread tension setting  S058 |
| F4 | Plural motions of cloth cutting knife Ineffective/effective  U019 |
| F5 | Cloth cutting knife size  U018 |

17. Performing continuous stitching

This sewing machine can perform continuous stitching which is capable of continuously sewing plural sewing pattern data without lifting the presser foot. It is possible to automatically sew up to maximum 6 shapes in one cycle.

In addition, registration of as many as 20 data can be performed. Copy and use the data to fill the needs.

→ Refer to "[V-14. Copying sewing pattern](#)" p.42

* It is necessary to change the parts from the state at that time of your purchase according to the setting conditions.

(1) Selection of continuous stitching data

1) Set the mode to the input mode.

Under the input mode where SET READY LED ⑳ goes out, the continuous-sewing data selection is enabled.

If the current mode is the sewing mode, press

READY key ②  to change over the mode to the input mode.

Only under the input mode, the continuous-sewing data selection is enabled.

2) Select continuous stitching.

Press ITEM SELECT key ⑥  to select the continuous-sewing screen A.

Press DATA CHANGE key ⑦  to select the continuous-sewing data No. B to be sewn.

3) Perform sewing.

When READY key ②  is pressed in the state where the continuous-sewing data is selected, SET READY LED ⑳ lights up to show that the sewing is enabled.

Continuous stitching data No. 1 only has been registered at the time of your purchase. However, sewing status cannot be obtained since the sewing pattern has not been inputted. Perform inputting of sewing pattern referring to **(2) Method of editing continuous stitching data** on the next page.

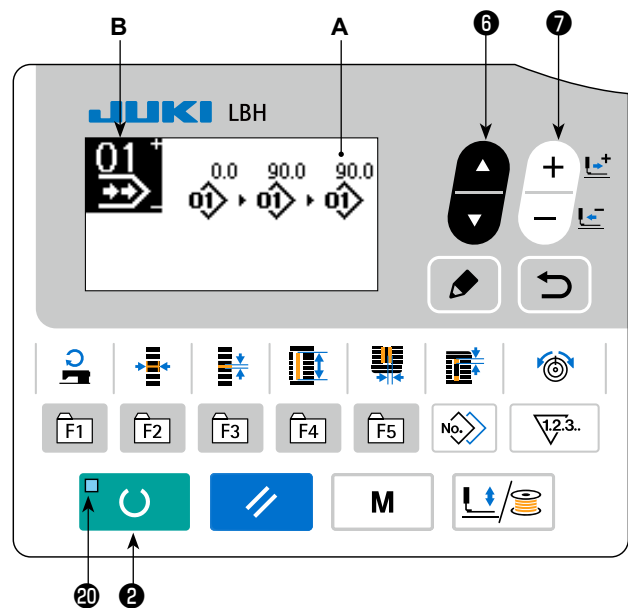

(2) Method of editing continuous stitching data

1) Set the mode to the input mode.

Under the input mode where SET READY LED ⑳ goes out, entry of the continuous-sewing data is enabled.

If the current mode is the sewing mode, press

READY key ②  to change over the mode to the input mode.

2) Set continuous stitching data to editing status.

When EDIT key ③  is pressed, the continuous-sewing data editing display C appears on the screen. The pattern No. D to be sewn is displayed in reverse video.

In this state, it is possible to edit the data.

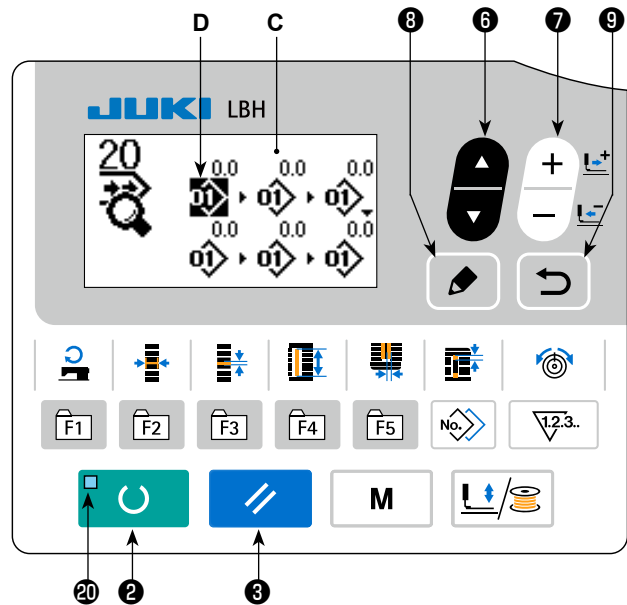

3) Select editing point.

When you press ITEM SELECT key ⑥ , the edit point will be changed in sequence and the currently-selected edit point is displayed in reverse video. When the edit point is carried to the last piece of data, the additional indication pictograph is displayed if there is an available pattern number. If you bring the edit point forward further, the data name will be the edit point.

When you press the EDIT key ③  while the edit point is being selected, the edit point data can be changed.

In the case the edit point is the pattern number

The additional indication pictograph is displayed at the selected position to enable insertion of pattern data.

In the case the edit point is the data name

The data name can be edited.

The selection sequence of edit points when the item select key is pressed

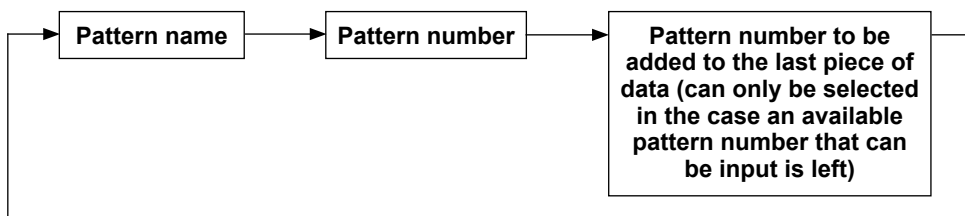

4) Change data of selected editing point.

Press DATA CHANGE key  , and data of editing point can be changed.

When the editing point is at the pattern No. :

Pattern No. which has been registered is displayed and it is possible to select.

When the editing point is at the jump feed :

It is possible to edit numerical value within the range of ± 120 mm.

In addition, press RESET key  and the pattern data of editing point can be deleted.

When RESET key  is held pressed for one second, all the registered pattern data can be deleted.

Repeat steps 3) and 4) to perform editing data.

5) Cancelling insertion of the pattern data.

When RESET key  is pressed while the addition command pictograph is displayed, insertion of the pattern data can be cancelled.

In addition, when READY key  is pressed, insertion of the pattern data is cancelled and the mode changes over to the sewing mode.

When RETURN key  is pressed, insertion of the pattern data is cancelled and the mode changes over to the input mode.

* **Input is completed by the steps above. For the continuous stitching, however, input all data within the range of the presser size. Error message will be shown when the data exceeds the range. Be sure to precisely input the presser size.**

→ Refer to "[V-4. Input of the presser type](#)" p.25

6) Creating new pattern data

Press COPY key  , under the input mode, to call the copy screen. Then, press ITEM SELECT

key  to select the new-creation pictograph. This enables the creation of new pattern data.

When you press DATA CHANGE key  while the new-creation pictograph is being selected, the pattern number to be newly created can be selected.

Then, select the pattern number to be newly created and press READY key  to create new pattern data.

18. Performing cycle stitching

This sewing machine can perform sewing of plural sewing pattern data in one cycle in the order of the data. As many as 30 different patterns can be entered. Use this function to sew two or more different buttonholes on sewing products.

In addition, registration of as many as 20 cycles can be performed. Copy and use the data to fill the needs.

→ Refer to "[V-14. Copying sewing pattern](#)" p.42

(1) Selection of cycle data

1) Set the mode to the input mode.

Under the input mode where SET READY LED ⑳ goes out, selection of the cycle data is enabled.

If the current mode is the sewing mode, press

READY key ㉑  to change over the mode to the input mode.

Only under the input mode, selection of the cycle data is enabled.

2) Select cycle stitching data.

Press ITEM SELECT key ⑥ , and patterns

which have been registered are changed over and displayed in order. Cycle data No. and continuous stitching data No. which have been registered after the last registered pattern No. are displayed. Here, select the cycle data No. which you desire to sew.

3) Perform sewing.

When READY key ㉑  is pressed in the state where the cycle data is selected, SET READY LED ⑳ lights up to show that the sewing is enabled.

Cycle data No. 1 only has been registered at the time of your purchase. However, sewing status cannot be obtained since the sewing pattern has not been inputted. Perform inputting of sewing pattern referring to **(2) Method of editing cycle data** on the next page.

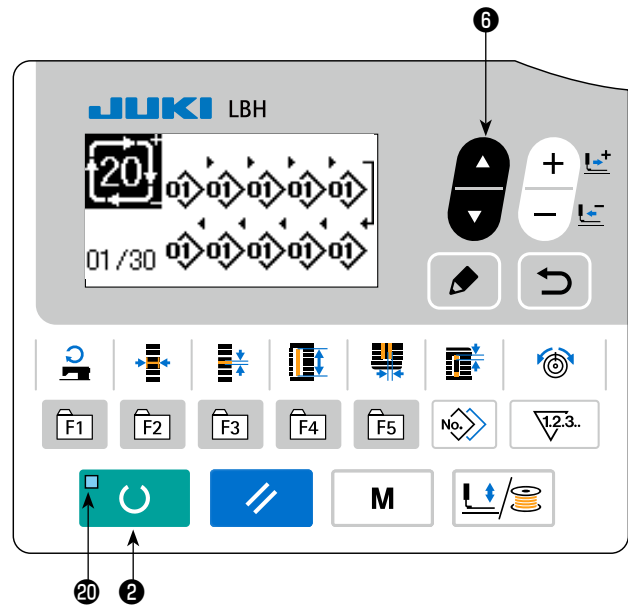

(2) Method of editing cycle data

1) Set the mode to input mode.

Under the input mode where SET READY LED ⑳ goes out, entry of the cycle data is enabled.

If the current mode is the sewing mode, press

READY key ②  to change over the mode to the input mode.

2) Set cycle data to editing status.

When EDIT key ③  is pressed, the cycle data editing display C appears on the screen. The pattern No. D to be sewn is displayed in reverse video.

In this state, it is possible to edit the data.

3) Select editing point.

When you press ITEM SELECT key ⑥ , the edit point will be changed in sequence and the currently-selected edit point is displayed in reverse video. When the edit point is carried to the last piece of data, the additional indication pictograph is displayed if there is an available pattern number. If you bring the edit point forward further, the data name will be the edit point.

When you press the EDIT key ③  while the edit point is being selected, the edit point data can be changed.

In the case the edit point is the pattern number

The additional indication pictograph is displayed at the selected position to enable insertion of pattern data.

In the case the edit point is the data name

The data name can be edited.

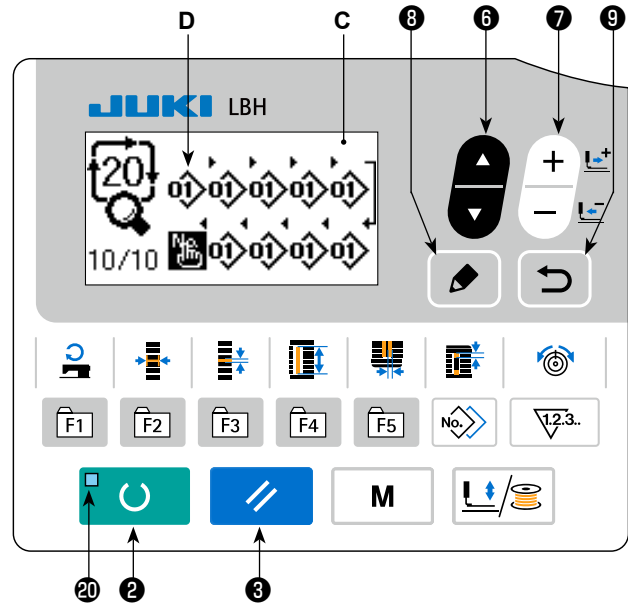

The selection sequence of edit points when the item select key is pressed

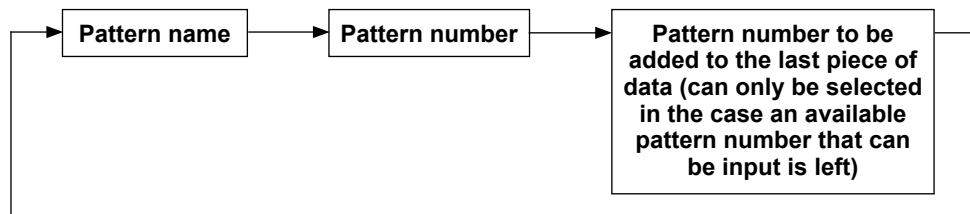

4) Change data of selected editing point.

Press DATA CHANGE key ⑦  and data of editing point can be changed.

Pattern No. which has been registered is displayed and it is possible to select.

In addition, press RESET key ③ , and the pattern data of editing point can be deleted.

When RESET key ③  is held pressed for one second, all the registered pattern data can be deleted.

Repeat steps 3) and 4) to perform editing data.



5) Cancelling insertion of the pattern data.

When RESET key ③  is pressed while the addition command pictograph is displayed, insertion of the pattern data can be cancelled.

In addition, when READY key ②  is pressed, insertion of the pattern data is cancelled and the mode changes over to the sewing mode.

When RETURN key ⑨  is pressed, insertion of the pattern data is cancelled and the mode changes over to the input mode.

6) Creating new pattern data

Press COPY key ⑱ , under the input mode, to call the copy screen. Then, press ITEM SELECT key ⑥  to select the new-creation pictograph. This enables the creation of new pattern data.

When you press DATA CHANGE key ⑦  while the new-creation pictograph is being selected, the pattern number to be newly created can be selected.

Then, select the pattern number to be newly created and press READY key ②  to create new pattern data.

19. How to change the name of cycle/continuous sewing data

1) Putting the data name in the edit state.

Refer to "[V-17. Performing continuous stitching](#)" p.46 and "[V-18. Performing cycle stitching](#)" p.49.

2) Changing the name of data.



Refer to "[V-11. Changing sewing data](#)" p.33.

20. Explanation of plural motions of knife



This sewing machine can automatically actuate the knife plural times and sew a buttonhole larger than the size of knife by setting the size of knife attached from the operation panel. Set and use this function when sewing various sewing shapes without replacing the knife.

(1) Setting of plural motions of knife

1) Set the mode to the input mode.

Under the input mode where SET READY LED  goes out, edit of the memory switch is enabled. If the current mode is the sewing mode, press READY key  to change over the mode to the input mode.

2) Input the size of cloth cutting knife.

Press MODE key  **M** to display memory switch data (level 1) edit screen **A**. Press ITEM SELECT key  to call **U018** Cloth cutting knife size **B**. Then set size **C** of knife attached with DATA CHANGE key .

→ For the details, refer to "[V-22. Memory switch data list](#)" p.54.

3) Set the function of the plural motions of cloth cutting knife to effective.

Next, press again ITEM SELECT key  to call **U019** Function of the plural motions of cloth cutting knife **D**. Then set the plural motions of cloth cutting knife to the effective status with

DATA CHANGE key .

→ For the details, refer to "[V-22. Memory switch data list](#)" p.54.

4) Perform sewing.

When READY key  is pressed, the sewing is enabled.

At this time, when S002 Cloth cutting length is set to a size larger than U018 Cloth cutting knife size which has been set above, the plural motions of knife is automatically performed for sewing.

* If a buttonhole smaller than the size of knife attached is desired to be sewn, error 489 will be displayed.

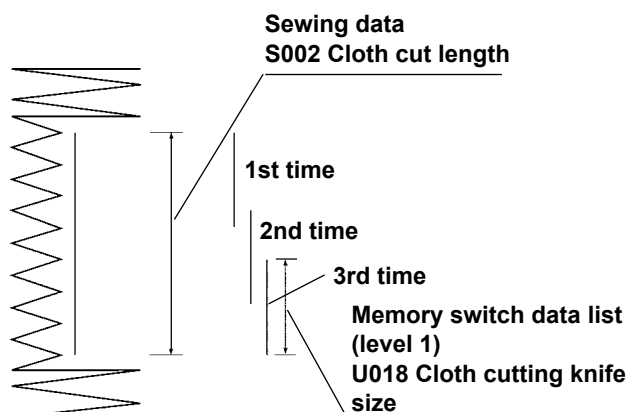
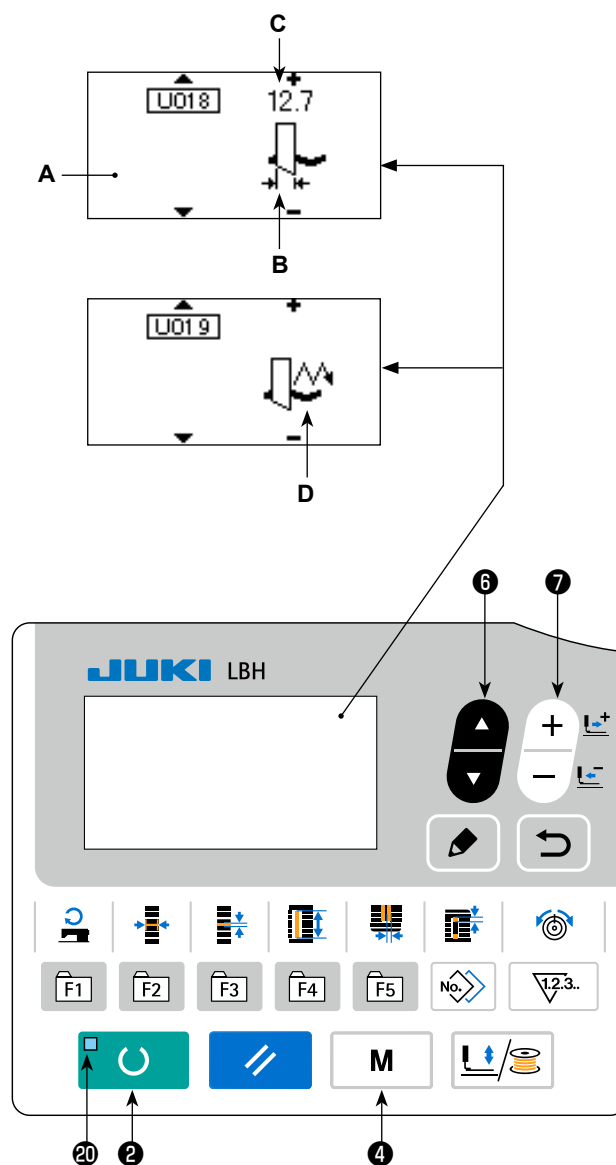

21. Method of changing memory switch data

1) Set the mode to input mode.

Under the input mode where SET READY LED ⑳ goes out, change to the memory switch data is enabled.

If the current mode is the sewing mode, press READY key ②  to change over the mode to the input mode.

2) Call memory switch data edit screen.

When MODE key ④  is pressed, the mode screen (operator level) is displayed. On this screen, select the memory switch data (level 1).

When MODE key ④  is held pressed for three seconds, the mode screen (maintenance personnel level) is displayed.

On this screen, the memory switch data (level 2) can be selected.

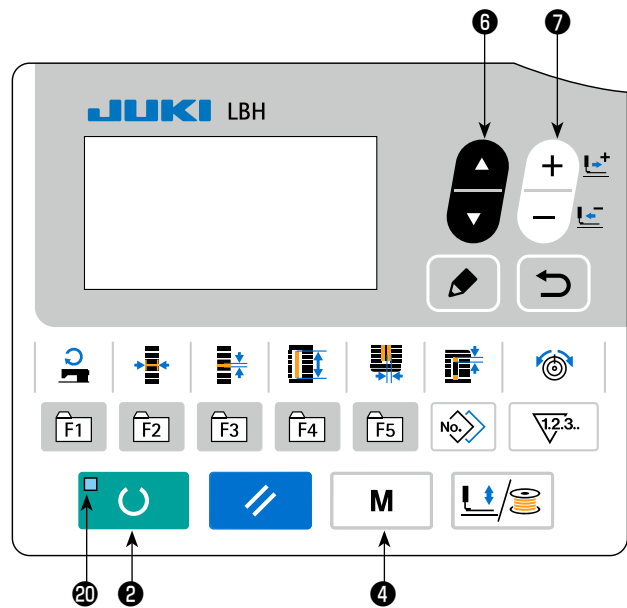



3) Select memory switch data to change.

Press ITEM SELECT key ⑥  and select the data item which you desire to change.

4) Change data.

There are one data item to change the numerical value and the other data item to select the pictograph in the memory switch data.

No. such as U001 is attached to the data item to change the numerical value. Set value can be changed by increasing/decreasing the value with DATA CHANGE key ⑦ .















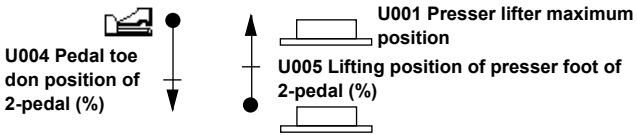



No. such as K001 is attached to the data item to select the pictograph. Pictograph can be selected with DATA CHANGE key ⑦ .





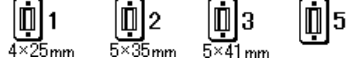









→ For the details of memory switch data, refer to ["V-22. Memory switch data list" p.54](#).

22. Memory switch data list

(1) Level 1









☆ Memory switch data (level 1) are the motion data that the sewing machine has in common and the data that operate on all sewing patterns in common.

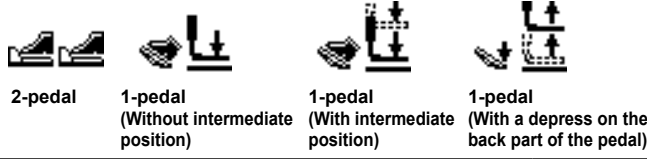

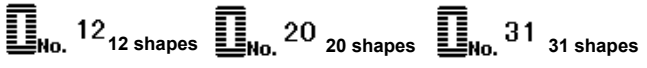
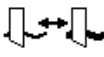



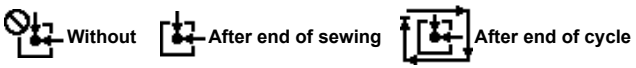





| No. | Item | Setting range | Edit unit | Initial value |
|------|---|---|-------------|---------------|
| U001 | Presser lifter maximum position Height of maximum position of pedal operation is set. |  0 to 17.0 | 0.1 mm | 8.0 mm |
| U002 | Presser lifter intermediate position Height of intermediate position of pedal operation is set. |  0 to 14.0 | 0.1 mm | 6.0 mm |
| U003 | Presser lifter cloth setting position Height of cloth setting position of pedal operation is set. |  0 to 14.0 | 0.1 mm | 0.0 mm |
| U004 | Pedal toe down position of 2-pedal (%) Operation feeling at the time of 2-pedal is set. Refer to the item below. |  5 to 95 | 1% | 80% |
| U005 | Lifting position of presser foot of 2-pedal (%) Operation feeling at the time of 2-pedal is set. Pedal toe down amount Presser lifting amount  U004 Pedal toe down position of 2-pedal (%) U005 Lifting position of presser foot of 2-pedal (%) U001 Presser lifter maximum position |  5 to 95 | 1% | 50% |
| U006 | Needle thread tension at sewing end setting |  0 to 200 | 1 | 35 |
| U007 | Needle thread tension at thread trimming setting |  0 to 200 | 1 | 35 |
| U008 | Needle thread tension of basting for sewing together setting |  0 to 200 | 1 | 60 |
| U009 | Soft-start speed setting 1st stitch |  400 to 4200 | 100 sti/min | 800 sti/min |
| U010 | Soft-start speed setting 2nd stitch |  400 to 4200 | 100 sti/min | 800 sti/min |
| U011 | Soft-start speed setting 3rd stitch |  400 to 4200 | 100 sti/min | 2000 sti/min |
| U012 | Soft-start speed setting 4th stitch |  400 to 4200 | 100 sti/min | 3000 sti/min |
| U013 | Soft-start speed setting 5th stitch |  400 to 4200 | 100 sti/min | 4000 sti/min |
| U014 | Kind of presser Set the kind of the presser. → Refer to "V-4. Input of the presser type" p.25.  | – | – | Type 1 |
| U015 | Presser size width When type 5 of U014 Kind of presser is set, input the width of the presser. |  3.0 to 10.0 | 0.1 mm | 3.0 mm |
| U016 | Presser size length When type 5 of U014 Kind of presser is set, input the length of the presser. |  10.0 to 150.0 | 0.5 mm | 10.0 mm |
| U017 | Sewing start position (Feed direction) Sewing start position in terms of presser is set. Set this item when starting position is desired to be shifted due to overlapped section or the like. |  2.5 to 110.0 | 0.1 mm | 2.5 mm |

| No. | Item | Setting range | Edit unit | Initial value |
|------|---|---------------|-----------|------------------|
| U018 | Cloth cutting knife size Input knife size used.  | 3.0 to 32.0 | 0.1 mm | 32.0 mm |
| U019 | Function of plural motions of cloth cutting knife Ineffective/effective  Ineffective  Effective | – | – | Ineffective |
| U020 | Function of thread breakage detection Ineffective/effective  Ineffective  Effective | – | – | Effective |
| U021 | Selection of presser position at the time of ON of READY key (Up/Down) Presser foot position when READY key is pressed is set.  Presser up  Presser down | – | – | Presser Up |
| U022 | Selection of the position of presser foot at the time of the end of sewing (Up/Down) This item sets the position of presser foot at the time of the end of sewing. (Effective only at the time of 1-pedal setting)  Presser up  Presser down | – | – | Presser Up |
| U023 | Needle thread trimming motion start distance Distance from the start of sewing to the start of needle thread trimmer release motion is inputted.  | 0 to 15.0 | 0.1 mm | 1.0 mm |
| U024 | Bobbin thread trimming motion start distance Distance from the start of sewing to the start of bobbin thread trimmer release motion is inputted.  | 0 to 15.0 | 0.1 mm | 1.5 mm |
| U025 | Counter updating unit Unit to update sewing counter is set.  | 1 to 30 | 1 | 1 |
| U026 | Total number of stitches Non-display/Display  Non-display  Display | – | – | Non-display |
| U027 | LED light luminance setting  | 0 to 5 | 1 | 5 |
| U500 | Language choice The language to be used for the display on the sewing panel is selected. * The number of selectable languages differs depending on the specifications of the sewing machine at the time of shipment. | – | – | Not yet selected |

(2) Level 2

☆ Press MODE switch for as long as three seconds and it is possible to edit.

| No. | Item | Setting range | Edit unit | Initial value |
|------|--|---------------|-------------|--|
| K001 | Pedal selection Pedal type is set. → Refer to "V-3. How to use the pedal" p.23.  | – | – | 1-pedal (Without intermediate position) |
| K003 | Function of prohibition of selection of kind of presser Permitted/Prohibited Prohibition of change of U014 Kind of presser is set.  | – | – | Change permitted |
| K004 | Sewing shape selection level Number of sewing shapes which can be sewn can be increased. (Max. 31 shapes)  | – | – | 12 shapes |
| K005 | Cloth cutting knife power Output power of cloth cutting knife is set. 0 : Min. power → 3 : Max. power  | 0 to 3 | 1 | 3 |
| K006 | Selection of machine type Type of sewing machine head is set. 0 : Standard type 1 : Dry head type  | 0 to 1 | 1 | 0 (Standard type) |
| K007 | Max. speed limitation speed setting Max. speed of sewing machine can be limited. When K006 Selection of machine type is set to dry head type, max. speed is automatically limited to 3300 sti/min.  | 400 to 4200 | 100 sti/min | 3600 sti/min |
| K008 | Compensation of unsteady needle thread tension Output value of needle thread tension is wholly offset and compensated.  | -30 to 30 | 1 | 0 |
| K009 | Output time of needle thread tension changed value When data related to needle thread tension is changed, the changed value is output as long as the set-up time.  | 0 to 20 | 1s | 0s |
| K010 | Function of origin retrieval each time Origin retrieval is performed after completion of sewing or completion of cycle.  | – | – | Without |
| K011 | Needle up by reverse run Permitted/Prohibited When U001 Presser lifter maximum position is set to 14.0 mm or more, motion of needle up by reverse run is automatically performed and the machine stops. Prohibition of the motion can be set.  | – | – | Permitted |

| No. | Item | Setting range | Edit unit | Initial value |
|------------|---|---------------|-----------|---|
| K018 | Pattern selection function under sewing mode Ineffective/effective  Ineffective  Effective | – | – | Ineffective |
| K019 | Thread trimming on the way in continuous stitching Permitted/Prohibited  Permitted  Prohibited | – | – | Permitted |
| K021 | Release amount of bobbin thread trimmer at the start of sewing This item sets the amount of releasing the bobbin thread trimmer at the start of sewing.  | 0 to 15 | 1 pulse | 8 |
| K022 | Presser lifter speed This item sets presser lifter speed.  | 1 to 3 | – | 3 |
| K023 | Work clamp error detecting position E083 The height at which the work clamp height error is detected is set. * If it is set at zero (0), the error will not be detected.  | 0 to 10.0 | 0.1 | 7.5 |
| K025 *1 | Selection of the shorter-thread remaining function With or without the shorter-thread remaining function is selected using this memory switch.  With the shorter-thread remaining function (LBH-1790AB)  Without the shorter-thread remaining function (LBH-1790A) | | | Without the shorter-thread remaining function |
| K028 | Setting of the holding power of Y-feed motor  1 Low  2 Medium  3 High | – | – | Low |

*1 : Do not change the setting.

23. How to change the sewing speed while the sewing machine is engaged in sewing

It is possible to change the sewing speed under the sewing mode.

1) Putting the sewing machine in the sewing mode.

When READY key **2**  is pressed in the state where the pattern data is selected, READY LED **20** lights up to enable sewing.

2) Displaying the sewing speed change screen.

When SEWING SPEED key **10**  is pressed, the sewing speed change screen **A** is displayed.

3) Changing the sewing speed.

The sewing speed can be changed in increments of 100 sti/min by pressing DATA CHANGE key **7**



The sewing speed can be maximized by pressing ITEM SELECT key **6**  and can be minimized (to 400 sti/min) by pressing ITEM SELECT key **6**



The maximum sewing speed will be either the speed set for the pattern data with "S084 Maximum speed limitation" or with "K007 Maximum restricted-speed setting", whichever the lower.

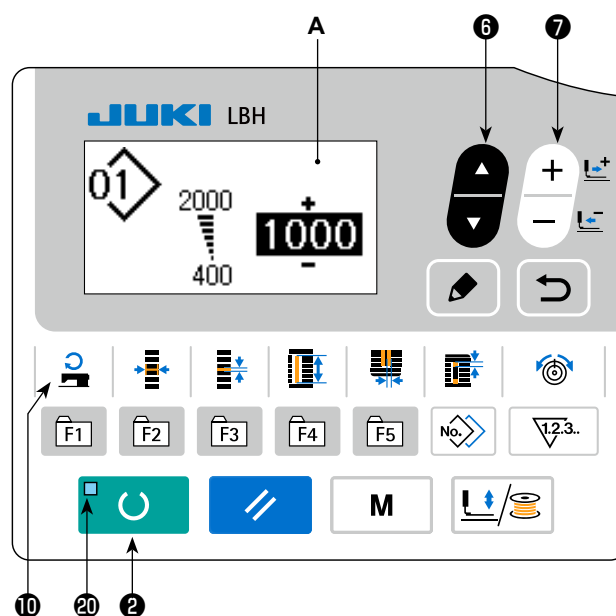

1. The sewing speed that can be changed on the sewing speed change screen is the actual sewing speed to be employed during sewing. To change the maximum sewing speed set for the pattern data with "S084 Maximum speed limitation", put the machine in the input mode and refer to "[V-11. Changing sewing data](#)" p.33.
2. Once the sewing speed is changed, the sewing speed for all pattern data is also changed. Even after the power is turned OFF, the changed sewing speed will remain in the memory.

24. How to adjust the pedal variable resistor

The variable resistor of the pedal can be adjusted by depressing the pedal or inputting a pedal variable resistor value on the operation panel.

1) Calling the pedal variable resistor adjustment screen.

Select the pedal variable resistor adjustment from the menu shown on the mode screen and press EDIT key **8**  to display the pedal variable resistor adjustment screen **A**.

2) Selecting the destination of registration of the pedal variable resistor value.

When ITEM SELECT key **6**  is pressed,

the destination of registration of the current pedal variable resistor value is changed and displayed in reverse video successively. Select the target destination of registration. The destination can be selected from the five ones shown in the table at the right.





3) Registering the pedal variable resistor value.

Press EDIT key **8**  to register and display the pedal variable resistor value on the selected destination of registration.

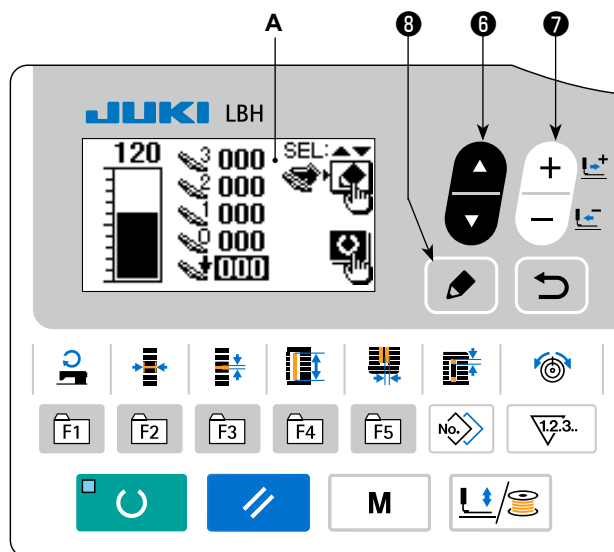
When you press DATA CHANGE key **7** 

during the selection of the registered pedal variable resistor value, you can modify the value. The modifiable range of the pedal variable resistor value is from 0 to 255.



| Display | Status of pedal to be registered |
|---|--|
|  | Pedal is fully depressed |
|  | Pedal is depressed to the neutral position |
|  | Pedal is lightly depressed |
|  | Pedal is not depressed |
|  | Back part of the pedal is depressed |

25. How to adjust the contrast

The contrast of the display on the panel can be adjusted in five steps.

1) Calling the contrast adjustment screen.

Select the contrast adjustment from the menu on the mode screen and press EDIT key **8** .

Then, the contrast adjustment screen **A** is displayed.

2) Adjusting the contrast.

The contrast can be adjusted in five steps from 0 (brightest) to 4 (darkest) by pressing DATA

CHANGE key **7** .

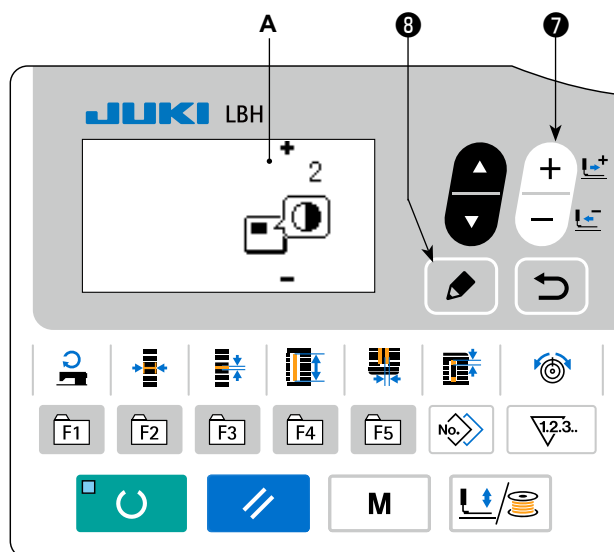

26. How to set the key lock

Operation of the data change key can be disabled by setting the key lock. Refer to the Engineer's Manual for how to invoke the key lock setting function and how to set the key lock.

27. Communication

This sewing machine is capable of inputting/outputting data by means of an USB thumb drive.



1) Entering the communication mode.

Referring to the mode screen in "V-15. How to edit/check the data other than sewing data" p.43, select the communication mode.

2) Selecting the type of communication.

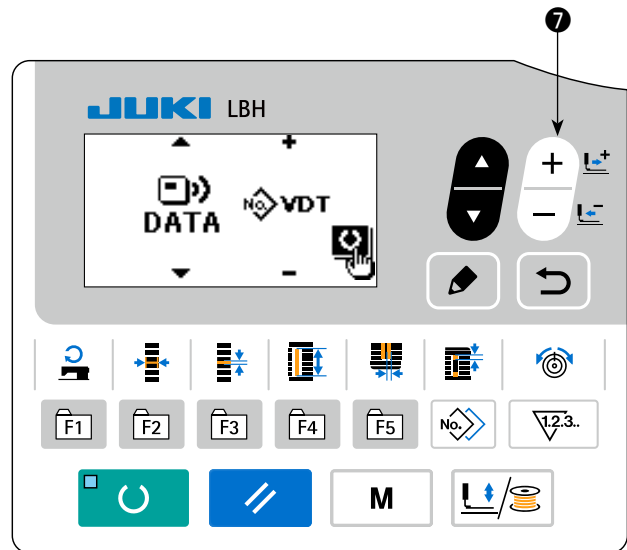
Press DATA CHANGE key  to select the type of communication.





| Name of data | | Extension | Description of data |
|------------------|---|-----------------|---|
| Parameter data |  | LBH00 XXX . EPD | Unique LBH sewing data form such as stitch shape, cloth trimming length and overedging width created with the sewing machine. |
| Vector form data |  | VD00 XXX .VDT | Data on needle entry points created with the PM-1. The data form is commonly used among JUKI sewing machine. |

* Refer to the Engineer's Manual for how to set the vector form data.

3) Selecting the communication direction.

Press ITEM SELECT key  to display pictograph **A** which shows the communication direction selection.

Press DATA CHANGE key  to select the communication direction.

 : Data shown on the operation panel is written on the USB thumb drive.

 : Data stored on the USB thumb drive is read into the operation panel.

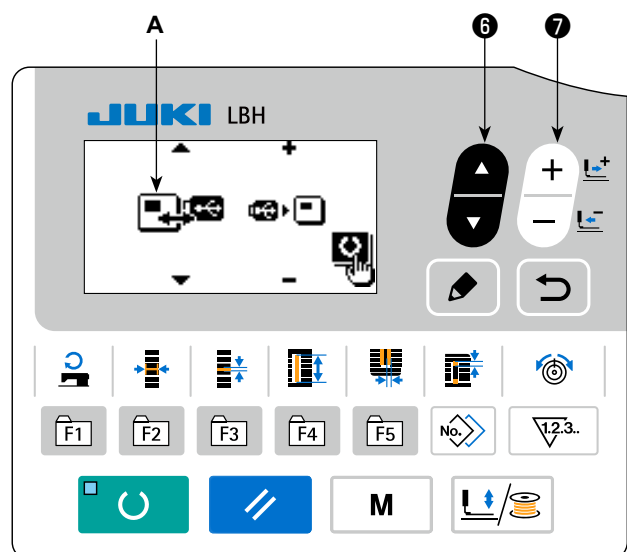

4) Selecting the number.

Press ITEM SELECT key **6**  to select file No. **B** to be read.

Press DATA CHANGE key **7**  to select file No. **C** to be written.

Press READY key **2**  to write the data in file No. **C**.

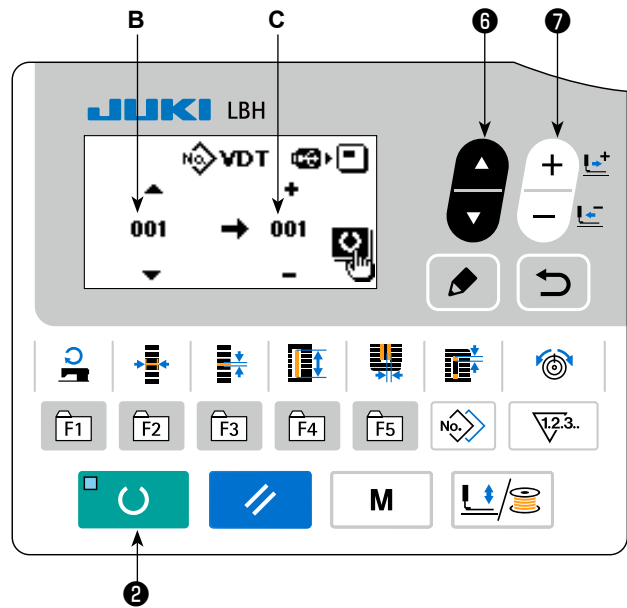

■ USB thumb drive

① Precautions to be taken when handling USB devices

- Do not leave the USB device or USB cable connected to the USB port while the sewing machine is in operation. The machine vibration can damage the port section resulting in loss of data stored on the USB device or breakage of the USB device or sewing machine.
- Do not insert/remove a USB device during reading/writing a program or sewing data. It may cause data breakage or malfunction.
- When the storage space of a USB device is partitioned, only one partition is accessible.
- Some type of the USB device may not be properly recognized by this sewing machine.
- JUKI does not compensate for loss of data stored on the USB device caused by using it with this sewing machine.
- When the panel displays the communication screen or pattern data list, the USB drive is not recognized even if you insert a medium into the slot.
- For USB devices and media such as CF(TM) cards, only one device/medium should be basically connected/inserted to/into the sewing machine. When two or more devices/media are connected/inserted, the machine will only recognize one of them. Refer to the USB specifications.
- Insert the USB connector into the USB terminal on the IP panel until it will go no further.
- Do not turn the power OFF while the data on the USB flash drive is being accessed.

② USB specifications

- Conform to USB 1.1 standard
- Applicable devices *1 ___ Storage devices such as USB memory, USB hub, FDD and card reader
- Not-applicable devices ___ CD drive, DVD drive, MO drive, tape drive, etc.
- Format supported ___ FD (floppy disk) FAT 12
Others (USB memory, etc.), FAT 12, FAT 16, FAT 32
- Applicable medium size ___ FD (floppy disk) 1.44MB, 720kB
Others (USB memory, etc.), 4.1MB ~ (2TB)
- Recognition of drives ___ For external devices such as a USB device, the device which is recognized first is accessed. However, when a medium is connected to the built-in media slot, the access to that medium will be given the highest priority. (Example: If a medium is inserted into the media slot even when the USB memory has already been connected to the USB port, the medium will be accessed.)
- Restriction on connection ___ Max. 10 devices (When the number of storage devices connected to the sewing machine has exceeded the maximum number, the 11th storage device and beyond will not be recognized unless they are once disconnected and re-connected.)
- Consumption current ___ The rated consumption current of the applicable USB devices is 500 mA at the maximum.

*1: JUKI does not guarantee operation of all applicable devices. Some device may not operate due to a compatibility problem.

VI. MAINTENANCE

1. Adjusting the needle-to-hook relation



WARNING :

To protect against possible personal injury due to abrupt start of the machine, be sure to start the following work after turning the power off and ascertaining that the motor is at rest.

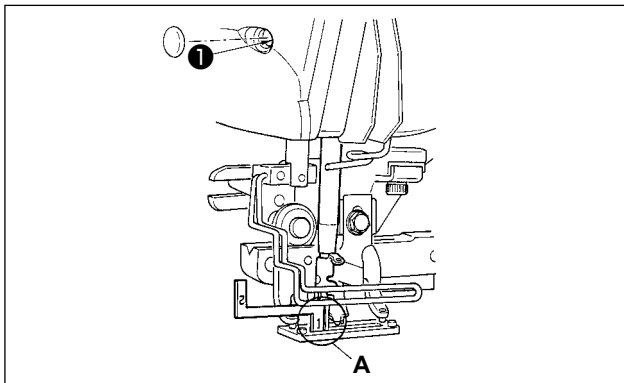

Adjust the needle-to-hook relation when the needle enters the center of the needle hole in the throat plate.

(1) Needle bar height

- 1) Bring down the needle bar to the lowest point.
- 2) Insert the part [1] **A** of timing gauge into the gap between the bottom end of needle bar and throat plate, where the bottom end of the needle bar touches the top of the part [1] **A** of the timing gauge.
- 3) Loosen needle bar connection screw **1**, and adjust the height of the needle bar.

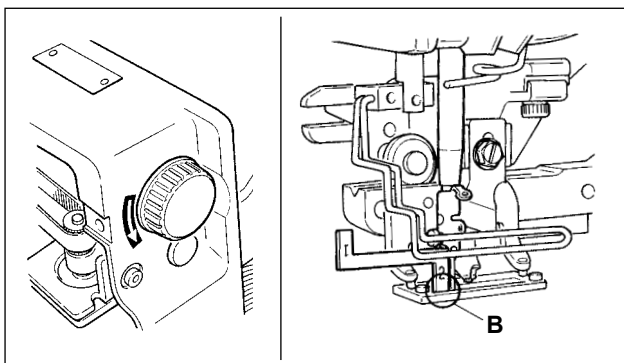

(2) Set the needle to hook relation in the following way :

- 1) Rotate the hand pulley in the correct direction until the needle starts to go up from its lowest point.
- 2) Insert the part [2] **B** of the timing gauge into the gap between the bottom end of the needle bar and the throat plate, where the bottom end of the needle bar touches the top of the part [2] **B** of the timing gauge.
- 3) Loosen setscrew **C** of the hook sleeve, and align blade point of the sewing hook with the center of needle hole. Make adjustment so that a clearance of approx. 0.05 mm is provided between the needle and the blade point of the hook.

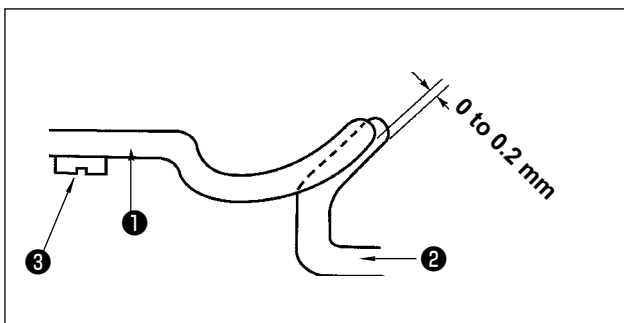
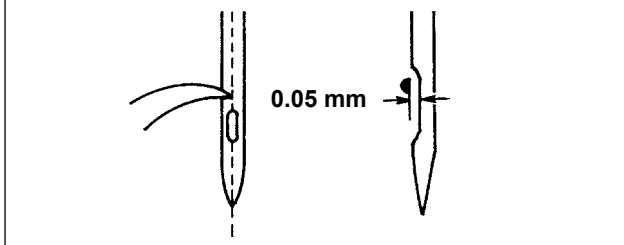
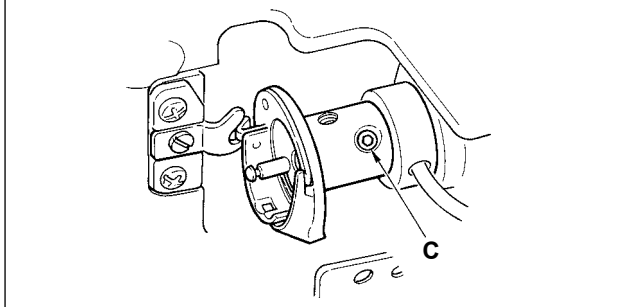

(3) Adjusting the bobbin case positioning stopper

Adjust with setscrew **3** so that the contact of the top end of bobbin case positioning stopper **1** and the end of inner hook **2** is 0 to 0.2 mm.

2. Adjusting the needle thread trimmer



WARNING :

To protect against possible personal injury due to abrupt start of the machine, be sure to start the following work after turning the power off and ascertaining that the motor is at rest.

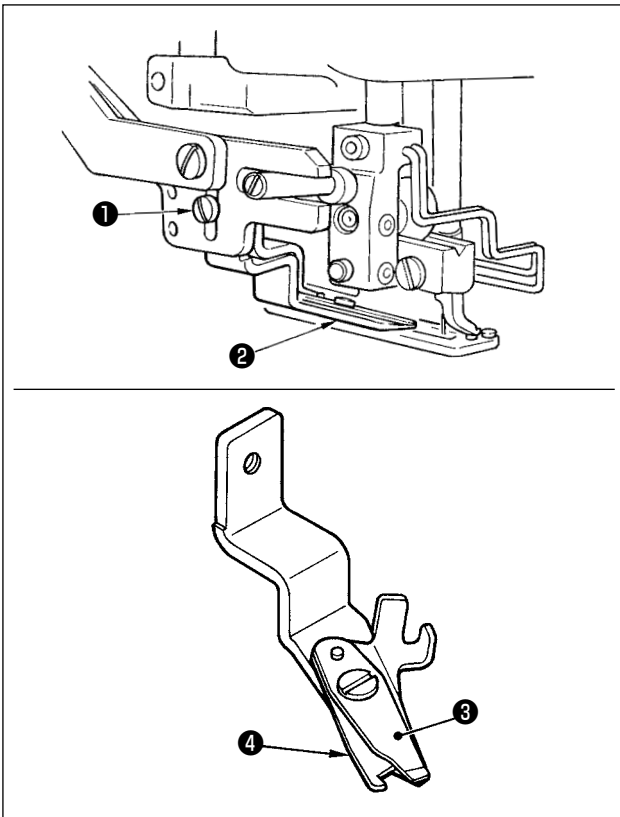

(1) Adjusting the thread grasping force of the needle thread trimmer

If the needle thread trimmer fails to provide consistent thread grasping force, the needle thread can slip off at the beginning of sewing.

- 1) If the thread grasping force of the needle thread trimmer has reduced, loosen setscrews **1** and detach needle thread trimmer **2**.
- 2) Slightly bend the top end of thread presser spring **3** so that it comes in contact with thread trimming blade of upper knife **4** over the length with no clearance and so that the needle thread trimmer securely holds the thread regardless of the position of the thread trimming blade at which the thread is trimmed.

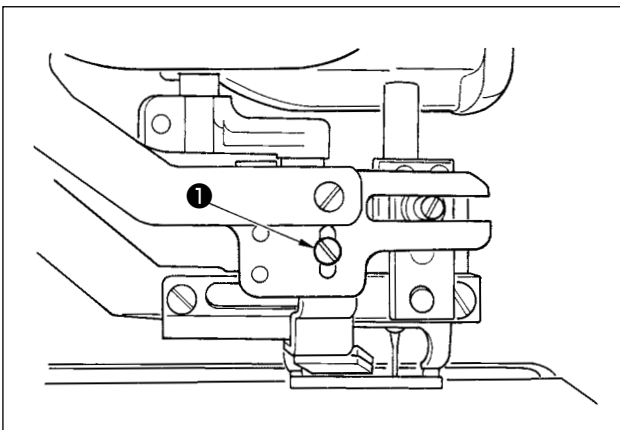

(2) Adjusting the height of the needle thread trimmer

To adjust the height of the needle thread trimmer, loosen setscrew **1**. Set the height of trimmer as low as possible, provided that it does not touch work clamp check, in order to minimize the length of remaining thread on the needle after trimming.

Note that the work clamp check tilts when sewing a multi-layered portion of the material, attach the needle thread trimmer to slightly raise the installing position of the trimmer.



When replacing the needle thread trimmer, make sure that the trimmer normally works under the needle thread trimmer adjusting mode.

3. Adjusting the presser bar pressure



WARNING :

To protect against possible personal injury due to abrupt start of the machine, be sure to start the following work after turning the power off and ascertaining that the motor is at rest.

The presser bar pressure should be set on a pattern-by-pattern basis.

1) Set the mode to the input mode.

Under the input mode where SET READY LED 20 goes out, change of the pattern is enabled.

If the current mode is the sewing mode, press

READY key 2  to change over the mode to the input mode.

2) Invoke "S090 Presser bar pressure"

Press EDIT key 8 . Then, press ITEM SE-

LECT key 6  to select presser bar pressure A.

Increasing the set value of S090 will increase the presser bar pressure to help prevent puckering.

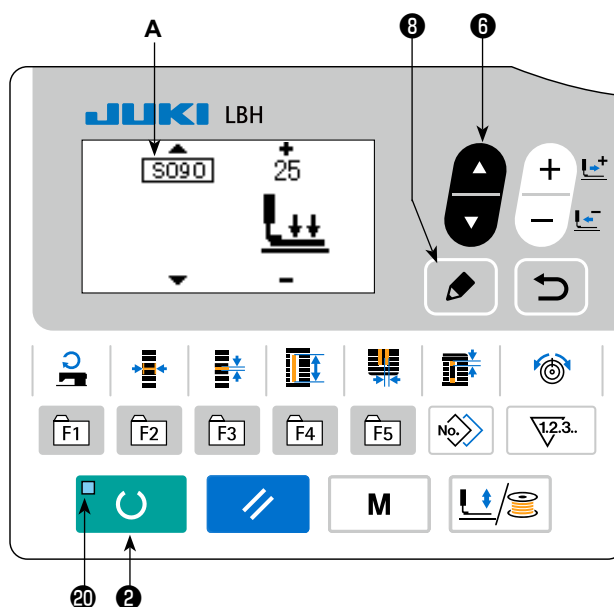

4. Adjustment of the bobbin presser unit



WARNING :

To protect against possible personal injury due to abrupt start of the machine, be sure to start the following work after turning the power off and ascertaining that the motor is at rest.

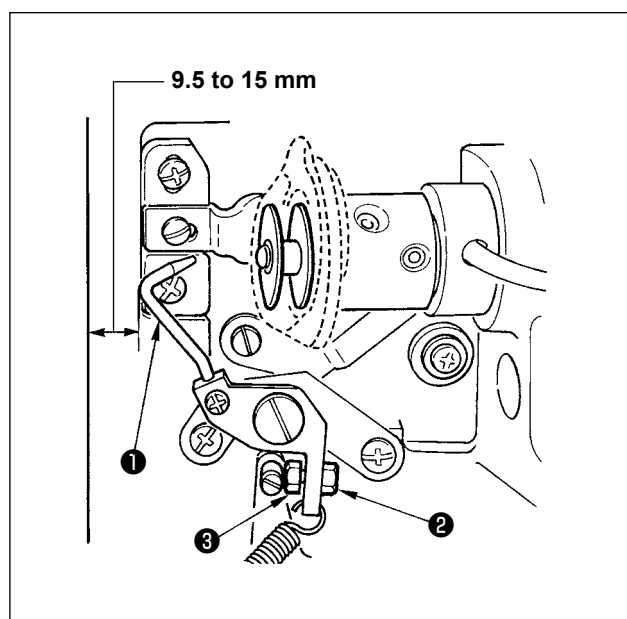

Loosen nut 1 and adjust the position with stopper spring 2 so that the distance from the front end of machine bed to bobbin presser 3 is 9.5 to 15 mm when the sewing machine stops. Then tighten nut 2.

5. Thread tension

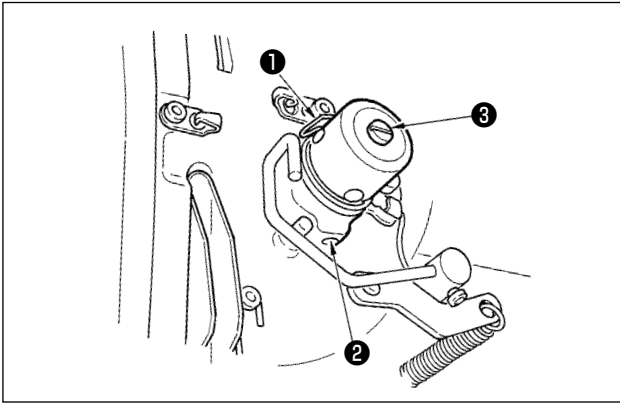

(1) Thread take-up spring (purl stitch)

- 1) The thread take-up amount of thread take-up spring ① is 8 to 10 mm, and the appropriate pressure at the start is approximately 0.06 to 0.1N.
- 2) To change the stroke of the thread take-up spring, loosen screw ②, insert a thin screwdriver into the slot of thread tension post ③, and turn it.
- 3) To change the pressure of the thread take-up spring, insert a thin screwdriver into the slot of thread tension post ③ while screw ② is tightened, and turn it. Turning it clockwise will increase the pressure of the thread take-up spring. Turning it counterclockwise will decrease the pressure.

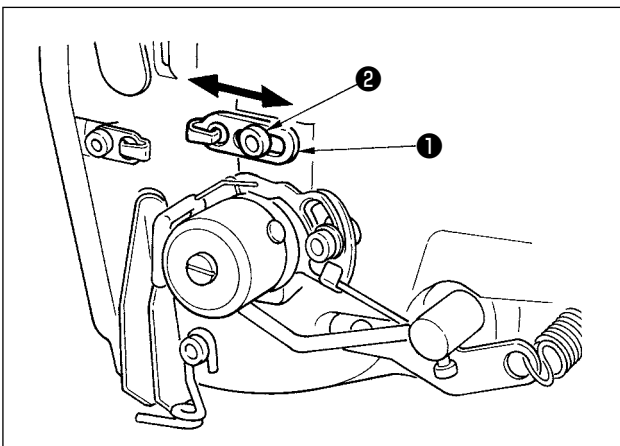

(2) Adjusting the thread take-up amount of the thread take-up lever

The thread take-up amount of the thread take-up lever should be adjusted in accordance with the thickness of the sewing products so as to obtain well-tightened stitches.

- a. For heavy-weight materials, loosen setscrew ② in thread guide ①, and move the thread guide to the left. The thread take-up amount of the thread take-up lever will be increased.
- b. For light-weight materials, move thread guide ① to the right. The thread take-up amount of the thread take-up lever will be reduced.

6. Replacing the fuse



WARNING :

1. To avoid electrical shock hazards, turn OFF the power and open the control box cover after about five minutes have passed.
2. Open the control box cover after turning OFF the power without fail. Then, replace with a new fuse with the specified capacity.

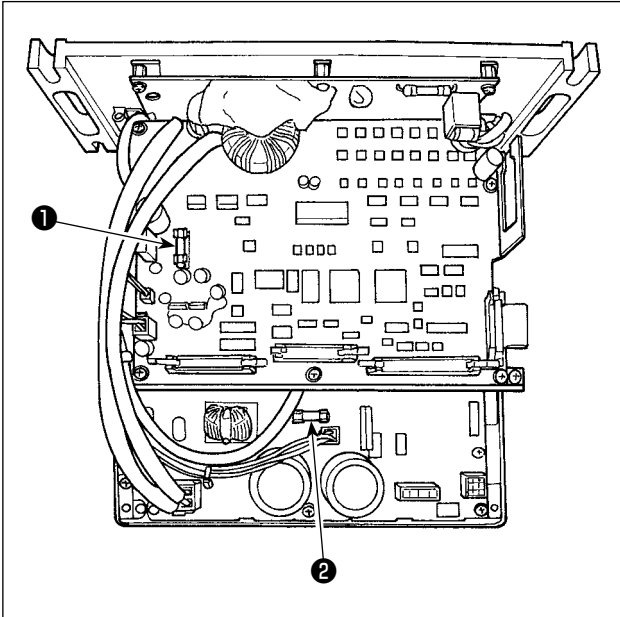

- 1) Turn OFF the power with the power switch after confirming that the sewing machine has stopped.
- 2) Draw the power cord from the power receptacle after confirming that the power switch is turned OFF.
Then wait for more than 5 minutes.
- 3) Remove four screws fixing the rear cover of the control box. Then slowly open the rear cover.
- 4) Grasp the glass section of the fuse to be replaced and remove it.
- 5) Use the fuse with the specified capacity.

❶ F1 fuse 5A
For DC+60V power protection
Fuse for power protection of pulse motor and AT solenoid

❷ F2 fuse 2A
For DC+24V power protection
Fuse for power protection such as solenoid valves and sensors

VII. GAUGE COMPONENTS

1. Cloth cutting knife

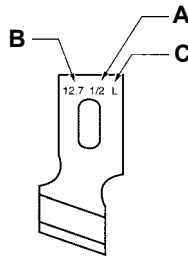

| A Knife size (inch) | B Knife size (mm) | C Mark | D Part No. |
|---------------------|-------------------|--------|--------------|
| 1/4 | 6.4 | F | B2702047F00 |
| 3/8 | 9.5 | K | B2702047K00A |
| 7/16 | 11.1 | I | B2702047I00 |
| 1/2 | 12.7 | L | B2702047L00A |
| 9/16 | 14.3 | V | B2702047V00 |
| 5/8 | 15.9 | M | B2702047M00A |
| 11/16 | 17.5 | A | B2702047A00 |
| 3/4 | 19.1 | N | B2702047N00 |
| 7/8 | 22.2 | P | B2702047P00 |
| 1 | 25.4 | Q | B2702047Q00A |
| 1-1/4 | 31.8 | S | B2702047S00A |

2. Throat plate

| Type | Stitch width | 5mm (Marking • AxB) |
|---------------|--------------|-------------------------|
| Standard (S) | | 40027553 (S5 • 1.4x6.2) |
| For knits (K) | | 40027554 (K5 • 1.2x6.2) |

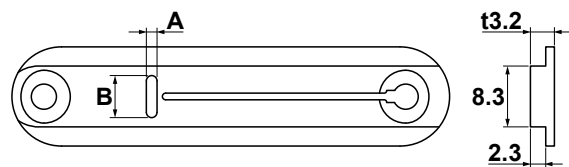







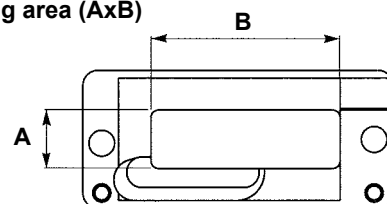











3. Presser















| Type | Stitch width (AxB) | 1 (4x25) | 2 (5x35) | 3 (5x41) | 5 (5x120,5x70) |
|---------------|--------------------|--------------|-------------|-------------|-----------------------------------|
| Standard (S) | | B1552781000A | B1552782000 | B1552783000 | 40008658(5x120) 14523708(5x70) |
| For knits (K) | | D1508771K00A | D1508772K00 | D1508773K00 | - |

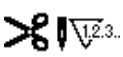



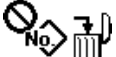

Sewing area (AxB)











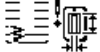

















VIII. ERROR CODE LIST



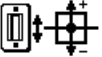
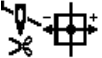

| Error code | | Description | How to recover | Place of recovery |
|------------|--|--|-------------------------------|-------------------|
| E001 |  | Contact of initialization of EEPROM of MAIN CONTROL p.c.b. When data is not written in EEPROM or data is broken, initialization of the data is automatically informed. | Turn OFF the power. | |
| E007 |  | Main shaft motor-lock When large needle resistance sewing product is sewn | Turn OFF the power. | |
| E011 |  | External media not inserted External media is not inserted. | Possible to recover by reset. | |
| E012 |  | Read error Data read from external media cannot be performed. | Possible to recover by reset. | Previous screen |
| E013 |  | Write error Data write from external media cannot be performed. | Possible to recover by reset. | Previous screen |
| E014 |  | Write protect External media is in the write prohibition state | Possible to recover by reset. | Previous screen |
| E015 |  | Format error Formatting of external media cannot be performed. | Possible to recover by reset. | Previous screen |
| E016 |  | External media capacity over Capacity of external media is short. | Possible to recover by reset. | Previous screen |
| E017 |  | EEP-ROM capacity over Capacity of EEPROM is short. | Possible to recover by reset. | Previous screen |
| E018 | TYPE  | Type of EEPROM is different When the mounted EEPROM is different in type. | Turn OFF the power. | Previous screen |
| E019 |  | File size over File size to be read in is too large. | Possible to recover by reset. | Previous screen |
| E022 |  | File No. error There is no designated file in the server or external media. | Possible to recover by reset. | Previous screen |
| E023 |  | Detection of step-out of presser lifting motor When step-out of motor is detected at the time when presser lifting motor passes origin sensor or starts operation. | Possible to recover by reset. | Standard screen |
| E024 |  | Pattern data size over When sewing cannot be performed since total size of continuous stitching data or size of downloaded data is too large. | Possible to recover by reset. | Standard screen |
| E025 |  | Detection of step-out of needle thread trimmer motor When step-out of motor is detected at the time when needle thread trimmer motor passes origin sensor or starts operation. | Possible to recover by reset. | Standard screen |
| E026 |  | Detection of step-out of bobbin thread trimmer motor When step-out of motor is detected at the time when bobbin thread trimmer motor passes origin sensor or starts operation. | Possible to recover by reset. | Standard screen |
| E030 |  | Needle bar upper position failure When needle does not stop at UP position even with needle UP operation at the time of starting sewing machine. | Possible to recover by reset. | Standard screen |
| E042 | - | Operation error Operation of sewing data cannot be performed. | Possible to recover by reset. | Data input screen |
| E043 |  | Enlargement error Stitching pitch exceeds 5 mm. | Possible to recover by reset. | Data input screen |
| E050 |  | Stop switch When stop switch is pressed during machine running. | Possible to recover by reset. | Step screen |

| Error code | | Description | How to recover | Place of recovery |
|------------|---|--|---|-------------------|
| E052 |  | Thread breakage detection error When thread breakage has occurred during machine running. | Possible to re-cover by reset. | Step screen |
| E061 |  | Memory switch data error When memory switch data is broken or revision is old. | Turn OFF the power. | |
| E062 |  | Sewing data error When sewing data is broken or revision is old. | Turn OFF the power. | |
| E081 |  | Needle rocking motor out-of-step detection error In the case the out-of-step of the X needle-rocking motor is detected. | Turn OFF the power. | |
| E082 |  | Feed motor out-of-step detection error In the case the out-of-step of the Y feed motor is detected. | Turn OFF the power. | |
| E083 |  | Presser foot position error In the case the presser foot height is excessively high at the time of starting sewing Adjust K023. | Turn OFF the power. | |
| E098 |  | Error caused by insufficient number of stitches required for thread trimming | Possible to re-enter after pressing reset key. | Standard screen |
| E099 |  | Interference of knife lowering command with thread trimming motion When inserting position of knife command is improper and knife command interferes with thread trimming motion in case of motion by data from external input device. | Possible to re-cover by reset. | Standard screen |
| E204 |  | Connection alert for the USB thumb drive which is used for sewing When sewing has been carried out by 10 or more times with the USB thumb drive inserted in the USB port. (Warning is given, in the case it is determined that a continuous sewing pattern is being sewn after the sewing machine has performed sewing by 10 times continuously, when the sewing machine completes sewing of the pattern.) | Possible to re-sewing after pressing reset key. | Standard screen |
| E302 |  | Machine head tilt or hook cover opening In the case the machine head tilt detection signal is ON | Possible to re-cover by reset. | Previous screen |
| E303 |  | Z phase sensor error of main shaft motor Z phase sensor of sewing machine motorencoder is abnormal. | Turn OFF the power. | |
| E304 |  | Cloth cutting knife sensor error When sensor is not OFF while knife is lowered. | Turn OFF the power. | |
| E402 |  | Individual sewing data deletion prohibition error In the case of attempting to delete the individual sewing data which has been registered in cycle/continuous sewing data. | Possible to re-cover by reset. | Previous screen |
| E407 |  | Continuous sewing data deletion prohibition error In the case of attempting to delete the continuous sewing data which has been registered in cycle data. | Possible to re-cover by reset. | Previous screen |
| E430 | * Count-up screen display (see page 31) | Count-up error | Possible to re-sewing after pressing reset key. | Sewing screen |

| Error code | | Description | How to recover | Place of recovery |
|------------|---|--|--|--|
| E485 |  | Number of times of basting unsetting error In the case the number of times of basting is not set (OFF) for "Basting+ Cloth cutting knife shape". | Possible to re-cover by reset. | (During individual sewing/cycle sewing) Sewing data edit screen [S034] Basting stitch (OFF/Number of times) (During continuous sewing) Standard screen |
| E486 |  | Eyelet knife length error Eyelet knife length is too short to form the shape in case of eyelet shape. | Possible to re-enter after pressing reset key. | (During individual sewing/cycle sewing) Sewing data edit screen [S017] Eyelet knife length (During continuous sewing) Standard screen |
| E487 |  | Eyelet shape length error Eyelet shape length is too short to form the shape in case of eyelet shape. | Possible to re-enter after pressing reset key. | (During individual sewing/cycle sewing) Sewing data edit screen [S014] Eyelet shape length (During continuous sewing) Standard screen |
| E488 |  | Taper bar-tacking compensation error When bar-tacking length is too short to form the shape in case of taper bar-tacking shape. | Possible to re-enter after pressing reset key. | (During individual sewing/cycle sewing) Sewing data edit screen [S008] 2nd bar-tacking length (During continuous sewing) Standard screen |
| E489 |  | Knife size error (at the time of plural motions of knife) When knife size is larger than cloth cutting knife size. | Possible to re-enter after pressing reset key. | (During individual sewing/cycle sewing) Sewing data edit screen [S002] Cloth cut length (During continuous sewing) Standard screen |
| E492 |  | Presser size over of basting When stitching data of basting exceeds presser size. | Possible to re-enter after pressing reset key. | (During individual sewing/cycle sewing) Sewing data edit screen [S040] Basting needle entry compensation (During continuous sewing) Standard screen |
| E493 |  | Presser size over of tie stitching at sewing end When stitching data of tie stitching at sewing end exceeds presser size. | Possible to re-enter after pressing reset key. | (During individual sewing/cycle sewing) Sewing data edit screen [S067] Tie stitching at sewing end width (During continuous sewing) Standard screen |

| Error code | | Description | How to recover | Place of recovery |
|------------|---|--|--|--|
| E494 |  | Presser size over of tie stitching at sewing start When stitching data of tie stitching at sewing start exceeds presser size. | Possible to re-enter after pressing reset key. | (During individual sewing/cycle sewing) Sewing data edit screen [S064] Tie stitching at sewing start width (During continuous sewing) Standard screen |
| E495 |  | Presser size error (Width direction : right only) When stitching data exceeds the size of right only of width direction of presser. | Possible to re-enter after pressing reset key. | (During individual sewing/cycle sewing) Sewing data edit screen [S003] Knife groove width, right or [S006] Ratio of right and left shapes (During continuous sewing) Standard screen |
| E496 |  | Presser size error (Width direction : left only) When stitching data exceeds the size of left only of width direction of presser. | Possible to re-enter after pressing reset key. | (During individual sewing/cycle sewing) Sewing data edit screen [S004] Knife groove width, left or [S006] Ratio of right and left shapes (During continuous sewing) Standard screen |
| E497 |  | Presser size error (Length direction : front) When stitching data exceeds the size of front of length direction of presser. | Possible to re-enter after pressing reset key. | Standard screen |
| E498 |  | Presser size error (Width direction : right and left) When stitching data exceeds the size of both right and left of width direction of presser. | Possible to re-enter after pressing reset key. | (During individual sewing/cycle sewing) Sewing data edit screen [S005] Overedging width, left (During continuous sewing) Standard screen |
| E499 |  | Presser size error (Length direction : rear) When stitching data exceeds the size of rear of length direction of presser. | Possible to re-enter after pressing reset key. | (During individual sewing/cycle sewing) Sewing data edit screen [S002] Cloth cut length (During continuous sewing) Standard screen |
| E703 |  | Panel is connected to the machine other than supposed. (Machine type error) When machine type code of system is improper in case of initial communication. | Turn OFF the power. | Communication screen |
| E704 |  | Nonagreement of system version When version of system software is improper in case of initial communication. | Turn OFF the power. | Communication screen |
| E730 |  | Main shaft motor encoder defectiveness or phase-out When encoder of sewing machine motor is abnormal. | Turn OFF the power. | |

| Error code | | Description | How to recover | Place of recovery |
|------------|---|---|---------------------|-------------------|
| E731 |  | Main motor hole sensor defectiveness or position sensor defectiveness When hole sensor or position sensor of sewing machine motor is defective. | Turn OFF the power. | |
| E733 |  | Reverse rotation of main shaft motor When sewing machine motor rotates in reverse direction. | Turn OFF the power. | |
| E801 |  | Phase-lack of power When phase-lack of input power occurs. | Turn OFF the power. | |
| E802 |  | Power instantaneous cut detection When input power is instantaneously OFF. | Turn OFF the power. | |
| E811 |  | Overvoltage In the case the input power source voltage/current is equal to or more than the specified value | Turn OFF the power. | |
| E813 |  | Low voltage In the case the input power source voltage/current is equal to or less than the specified value | Turn OFF the power. | |
| E820 |  | 24 VDC fuse has blown out When the SDC fuse has blown out. | Turn OFF the power. | |
| E901 |  | Abnormality of main shaft motor IPM When IPM of servo control p.c.b. is abnormal. | Turn OFF the power. | |
| E902 |  | Overcurrent of main shaft motor When current flows excessively to sewing machine motor. | Turn OFF the power. | |
| E903 |  | Abnormality of stepping motor power In the case the stepping motor power of the servo-control PCB is out of the range of the specified values | Turn OFF the power. | |
| E904 |  | Abnormality of solenoid power In the case the solenoid power of the servo-control PCB is out of the range of the specified values | Turn OFF the power. | |
| E905 |  | Abnormality of temperature of heat sink for servo control p.c.b. When temperature of heat sink of servo control p.c.b. is 85°C or more. | Turn OFF the power. | |
| E907 |  | Needle rocking motor origin retrieval error When origin sensor signal is not inputted at the time of origin retrieval motion. | Turn OFF the power. | |
| E908 |  | Y feed motor origin retrieval error When origin sensor signal is not inputted at the time of origin retrieval motion. | Turn OFF the power. | |
| E909 |  | Needle thread trimmer motor origin retrieval error When origin sensor signal is not inputted at the time of origin retrieval motion. | Turn OFF the power. | |
| E910 |  | Presser motor origin retrieval error When origin sensor signal is not inputted at the time of origin retrieval motion. | Turn OFF the power. | |
| E911 |  | Bobbin thread trimmer motor origin retrieval error When origin sensor signal is not inputted at the time of origin retrieval motion. | Turn OFF the power. | |
| E912 | - | Sewing motor speed detection error In the case the sewing machine motor malfunctions | Turn OFF the power. | |
| E915 |  | Abnormality of communication between operation panel and main CPU When abnormality occurs in communication. | Turn OFF the power. | |
| E916 |  | Abnormality of communication between main CPU and main shaft CPU When abnormality occurs in communication. | Turn OFF the power. | |

| Error code | | Description | How to recover | Place of recovery |
|------------|---|---|---------------------|-------------------|
| E918 |  | Abnormality of temperature of heat sink for main control p.c.b. When temperature of heat sink of main control p.c.b. is 85°C or more. | Turn OFF the power. | |
| E943 |  | Defectiveness of EEPROM of main control p.c.b. When data writing to EEPROM is not performed. | Turn OFF the power. | |
| E946 |  | Defectiveness of writing to EEPROM of head relay p.c.b. When data writing to EEPROM is not performed. | Turn OFF the power. | |
| E998 |  | Presser deviation error In the case the presser foot fails to go up when the pedal is released or when the sewing is finished. Turn the power OFF. Check whether the work clamp can be lifted/lowered manually. During the aforementioned check, be careful about the needle and the knife. | Turn OFF the power. | |
| E999 |  | When cloth cutting knife does not return <ul style="list-style-type: none"> • When cloth cutting knife does not return after the lapse of predetermined time. • When sensor is not turned ON while cloth cutting knife is raising (at the time of waiting). | Turn OFF the power. | |

IX. TROUBLES AND CORRECTIVE MEASURES

| Troubles | Causes | Corrective measures | Page |
|---|---|--|------|
| 1. Needle thread breakage | 1. Thread tension at parallel section is too high. | ○ Decrease the thread tension at parallel section. | 27 |
| | 2. Pressure or stroke of thread take-up spring is too large. | ○ Decrease the tension of thread take-up spring or decrease its stroke. | 67 |
| | 3. There is a burr or scratch on the blade point of hook. | ○ Buff the blade point of hook. Or, replace the hook. | – |
| | 4. Hook timing is not proper. | ○ Adjust again the hook timing with timing gauge. | 64 |
| | 5. There is a scratch on the thread path. | ○ Polish the thread path with sand paper and buff it. | – |
| | 6. Attaching needle is wrong. | ○ Adjust again the direction, height, etc. | 16 |
| | 7. Needle is too thin. | ○ Replace the needle with a thicker one. | – |
| | 8. Needle tip is damaged. | ○ Replace the needle. | – |
| | 9. Thread breaks when it is bent. | ○ Do not pass the thread through the thread guide pin. | 13 |
| 2. Needle thread slips off. | 1. Needle thread trimmer opens too early. | ○ Delay the opening timing of the needle thread trimmer. | 65 |
| | 2. Whip stitching is not formed at the start of sewing. (Tension at the start of sewing is too high.) | ○ Decrease tension at the start of sewing. | 39 |
| | 3. Threading needle thread is wrong. | ○ Thread properly again. | 17 |
| | 4. Speed at the start of sewing is too fast. | ○ Set the soft-start function. | 54 |
| 3. Wobbling at parallel section | 1. Thread tension at parallel section is too low. | ○ Increase the thread tension at parallel section. | 27 |
| | 2. Bobbin thread tension is too high. | ○ Decrease bobbin thread tension. (Purl stitching : 0.05 to 0.1N) | 18 |
| | 3. Pre-tension is too low. | ○ Increase pre-tension. | – |
| 4. Wobbling at the start of sewing | 1. Thread tension at parallel section is too low. | ○ Increase the thread tension at parallel section. | 27 |
| | 2. Position of needle thread trimmer is too high. | ○ Lower the needle thread trimmer to such an extent that it does not come in contact with the presser. | 65 |
| | 3. Stroke of thread take-up spring is too large. | ○ Decrease the stroke of thread take-up spring. | 67 |
| 5. Needle thread appears on the wrong side of material at bar-tacking section in dumping condition. | 1. Bar-tacking thread tension is too low. | ○ Increase the bar-tacking thread tension. | 27 |
| | 2. Bobbin thread tension is too high. | ○ Decrease the bobbin thread tension. (0.05 to 0.1N) | 18 |
| | 3. Number of stitches of radial shape is too many. | ○ Decrease the number of stitches. | 37 |
| | 4. Tension at the end of sewing is too low. | ○ Increase tension at the end of sewing. | 54 |
| 6. Stitches float. | 1. Bobbin thread tension is too low. | ○ Increase the bobbin thread tension. | 18 |
| | 2. Bobbin thread comes off bobbin case. | ○ Perform proper threading the bobbin case. | 17 |
| | | ○ Take care that the winding amount of bobbin thread is not excessive. | 29 |
| 7. Stitch skipping | 1. Button hole is small in terms of the size of presser. | ○ Replace the presser with a smaller one. | – |
| | 2. Material flops because of light-weight. | ○ Delay the hook-to-needle timing. (Lower the needle bar by 0.5 mm.) | 64 |
| | 3. Attaching needle is wrong. | ○ Adjust again the direction, height, etc. | 16 |
| | 4. Needle is bent. | ○ Replace the needle. | – |
| | 5. There is a burr or scratch on the blade point of hook. | ○ Buff the blade top of hook. Or, replace the hook. | – |

| Troubles | Causes | Corrective measures | Page |
|--|---|--|-------------|
| 8. Thread frays. | 1. Number of stitches of tie stitching is too small. | ○ Increase the number of stitches of tie stitching at the end of sewing. | 40 |
| | 2. Width of tie stitching is too wide. | ○ Narrow the width of tie stitching at the end of sewing. | 40 |
| 9. Length of needle thread remaining at the end of sewing is too long. | 1. Width of tie stitching is too narrow. | ○ Widen the width of tie stitching at the end of sewing. | 40 |
| | 2. Tension of tie stitching is too low. | ○ Increase tension at the end of sewing. | 54 |
| 10. Needle thread breaks at the start of sewing, or the wrong side of seam is dirty. | 1. Tension at the start of sewing is too low. | ○ Increase tension at the start of sewing. | 39 |
| 11. Knife drops even when needle thread is cut. | 1. Check whether the thread breakage detector plate is properly adjusted. | ○ Adjust the detector plate. (Refer to the Engineer's Manual.) | – |
| 12. Needle breaks. | 1. Check whether needle is bent. | ○ Replace the needle. | 16 |
| | 2. Check whether needle comes in contact with the blade point of hook. | ○ Adjust the needle-to-hook timing. | 64 |
| | 3. Check whether needle thread trimmer comes in contact with needle when it opens. | ○ Adjust the installing position of needle thread trimmer. | 65 |
| | 4. Check whether needle comes in the center of the needle hole of throat plate. | ○ Re-adjust the installing position of throat plate base. | – |
| | 5. Needle stop position is too low and needle comes in contact with needle thread trimmer when it closes. | | |
| 13. Knife drops plural times. | 1. Check whether the cloth cutting knife dropping is set to plural dropping. | ○ Release the plural time setting. | 52 |

X. DRAWING OF THE TABLE

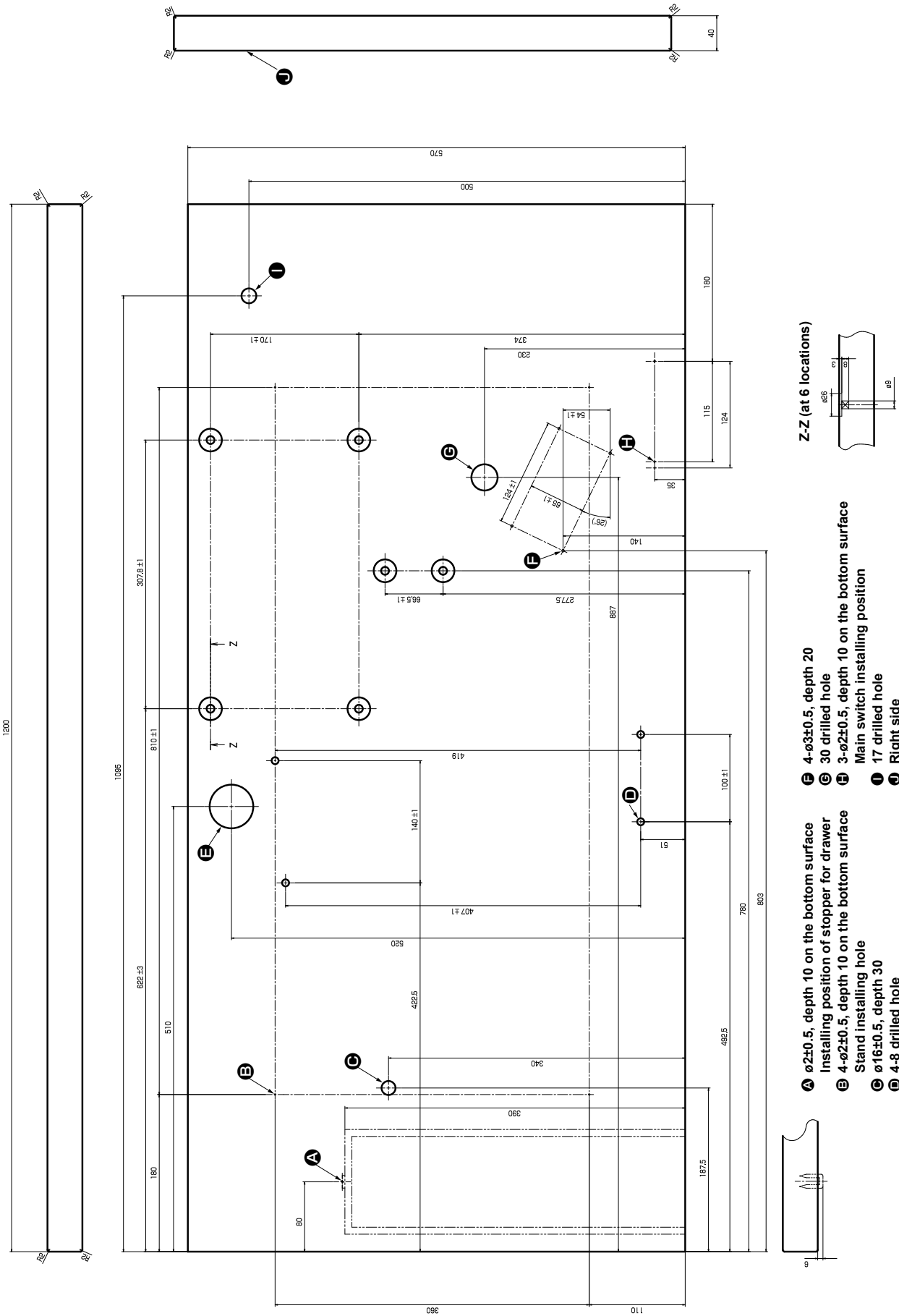

• Drawing of the table for the sewing machine with a two-pedal unit

