

ENGLISH

**APW-896/IP-420
INSTRUCTION MANUAL**

* "CompactFlash(TM)" is the registered trademark of SanDisk Corporation, U.S.A.

CONTENTS

| | |
|---|-----------|
| I . CAUTIONS BEFORE OPERATION | 1 |
| II . CONFIGURATION OF THE MACHINE | 2 |
| III . SPECIFICATIONS | 3 |
| 1. MECHANICAL SPECIFICATIONS | 3 |
| 2. ELECTRICAL SPECIFICATIONS | 3 |
| IV . INSTALLATION | 4 |
| 1. REMOVING PACKING MATERIALS | 4 |
| 2. SECURING THE MACHINE | 4 |
| 3. CONNECTING THE FOOT PEDAL | 5 |
| 4. CONNECTING THE AIR COUPLER | 5 |
| 5. CONNECTING THE POWER PLUG | 6 |
| 6. ASSEMBLING THE THREAD STAND AND ATTACHING IT TO THE MACHINE | 7 |
| 7. INSTALLING SP-46 (CLAMP BAR STACKER) (OPTIONAL PART NO. : 40058952) | 7 |
| 8. INSTALLING SP-47 (ROLLER STACKER) (OPTIONAL PART NO. : 40058953) | 8 |
| 9. REMOVING THE HEAD FIXING PLATE | 9 |
| 10. INSTALLING THE SUB-TABLE | 9 |
| 11. INSTALLING OPERATION PANEL IP-420 | 9 |
| 12. LUBRICATING THE OIL TANK | 10 |
| 13. INSTALLING SA-120 (INTERLINING SUPPLYING DEVICE) (OPTIONAL PART NO. : 40045772) | 11 |
| 14. ADJUSTMENT OF SA-120 (INTERLINING SUPPLYING DEVICE) (OPTIONAL PART NO. : 40045772) | 12 |
| V . PREPARATION OF THE SEWING MACHINE | 13 |
| 1. HOW TO OPERATE THE SEWING MACHINE HEAD | 13 |
| (1) How to attach the needles | 13 |
| (2) Thread used | 13 |
| (3) How to pass the needle thread | 14 |
| 2. HOW TO REMOVE THE SEWING TABLE | 15 |
| (1) When replacing the bobbin thread | 15 |
| (2) Cautions to be taken when the sewing tables are removed | 16 |
| 3. HOW TO WIND THE BOBBINS | 17 |
| 4. HOW TO THREAD THE BOBBIN CASE | 18 |
| 5. HOW TO INSTALL THE BOBBIN CASE | 18 |
| 6. HOW TO ADJUST THE THREAD TENSION | 19 |
| 7. SETTING THE MATERIAL TO BE SEWN | 20 |
| (1) Setting a garment body | 20 |
| 8. ADJUSTING THE MATERIAL GUIDE | 20 |
| VI . HOW TO USE THE OPERATION PANEL | 21 |
| 1. PREFACE | 21 |
| 2. BASIC OPERATION OF THE OPERATION PANEL (IP-420) | 24 |
| (1) Configuration of IP-420 | 24 |
| (2) Buttons used in common | 25 |
| (3) Basic operation | 25 |
| 3. EXPLANATION OF THE BASIC SCREEN | 28 |
| (1) Input screen (Independent sewing mode) | 28 |
| (2) Sewing screen (Independent sewing mode) | 29 |

| | |
|--|-----------|
| (3) Input screen (Alternate sewing mode) | 30 |
| (4) Sewing screen (Alternate sewing mode) | 31 |
| (5) Input screen (Cycle sewing mode)..... | 32 |
| (6) Sewing screen (Cycle sewing mode) | 33 |
| 4. USING THE COUNTER | 34 |
| (1) Setting procedure of the counter..... | 34 |
| (2) Releasing procedure of count-up..... | 37 |
| (3) Counter value changing procedure during sewing | 37 |
| 5. USING THE BOBBIN THREAD AMOUNT ADJUSTMENT COUNTER..... | 38 |
| (1) Setting procedure of the bobbin thread remaining amount adjustment counter | 38 |
| (2) Releasing procedure of the bobbin thread remaining amount detection count-up | 40 |
| 6. CHANGING THE SEWING MODE | 41 |
| 7. USING THE SEWING PATTERN..... | 42 |
| (1) Performing the selection of pattern..... | 42 |
| (2) Performing the new creation of pattern..... | 43 |
| (3) Copying the pattern..... | 44 |
| (4) Erasing the pattern..... | 46 |
| (5) Naming the pattern | 47 |
| (6) Editing procedure of the cycle sewing data | 48 |
| 8. CHANGING THE SEWING DATA..... | 50 |
| (1) Changing procedure of the sewing data | 50 |
| (2) Sewing data list..... | 51 |
| (3) Copying function of the upper and lower alternate sewing data | 62 |
| 9. CHANGING THE MEMORY SWITCH DATA | 64 |
| (1) Changing procedure of the memory switch data | 64 |
| (2) Memory switch data list..... | 65 |
| 10. PERFORMING OPTIONAL SETTING | 73 |
| (1) Changing procedure of the optional setting | 73 |
| (2) Optional setting list..... | 74 |
| 11. CHANGING THE DEVICE SETTING | 75 |
| (1) Changing procedure of the device setting | 75 |
| (2) Device setting list..... | 76 |
| 12. CUSTOMIZING THE PEDAL OPERATION..... | 77 |
| (1) Method to select and use the customized data..... | 77 |
| (2) Customizing the pedal operation data | 78 |
| 13. CUSTOMIZING THE DATA INPUT SCREEN | 80 |
| (1) Customizing procedure | 80 |
| 14. PERFORMING THE CUSTOMIZING SETTING OF THE SEWING SCREEN | 82 |
| (1) Customizing procedure | 82 |
| 15. USING THE INFORMATION..... | 84 |
| (1) Observing the maintenance inspection information | 85 |
| (2) Releasing procedure of the warning | 86 |
| (3) Observing the production control information | 87 |
| (4) Performing setting of the production control information | 89 |
| (5) Observing the operation measurement information..... | 91 |
| 16. USING THE COMMUNICATION FUNCTION | 93 |
| (1) Handling possible data | 93 |
| (2) Performing communication by using the media..... | 93 |
| (3) Performing communication by using USB | 93 |
| (4) Take-in of the data | 94 |
| (5) Take-in of plural data together | 95 |

| | |
|---|------------|
| 17. PERFORMING FORMATTING OF THE MEDIA..... | 97 |
| VII. MAINTENANCE | 98 |
| 1. INSPECTION | 98 |
| (1) Maintenance and inspection of the pneumatic device | 98 |
| (2) Maintenance and inspection related to the sewing machine | 98 |
| (3) With regard to the waste oil of the hook oil | 99 |
| (4) With regard to the cleaning of the hook shaft base | 99 |
| 2. MARKING LIGHT..... | 100 |
| (1) Marking light for sewing reference setting | 100 |
| (2) Adjusting the marking light irradiation position..... | 100 |
| 3. REPLENISHING GREASE TO THE DESIGNATED PLACE..... | 101 |
| (1) Grease-up procedure..... | 102 |
| 4. CONSUMABLE REPLACEMENT COMPONENTS..... | 104 |
| 5. TILTING THE MACHINE..... | 105 |
| 6. STANDARD OF REPLACING TIME OF THE GAS SPRING..... | 106 |
| 7. REPLACING PROCEDURE BETWEEN DOUBLE-WELT AND SINGLE-WELT..... | 107 |
| (1) Replacing procedure between double-welt and single-welt..... | 107 |
| (2) Fine adjustment of the position of garment body clamp | 107 |
| (3) Replacing the binder | 108 |
| 8. CORNER KNIFE | 109 |
| (1) Corner knife unit..... | 109 |
| (2) Adjusting the corner knife..... | 110 |
| (3) Corner knife adjustment function screen | 111 |
| (4) Corner knife actuating position setting procedure..... | 113 |
| (5) Feature of the corner knife actuating position setting | 114 |
| (6) Deflection amount setting | 116 |
| 9. CENTER KNIFE | 117 |
| (1) Center knife actuating position setting procedure..... | 117 |
| (2) Feature of the center knife actuating position setting | 118 |
| 10. ADJUSTING THE POSITION OF THE SENSOR FOR DETECTING FLAPS..... | 120 |
| 11. CAUSES AND CORRECTIVE MEASURES AGAINST TROUBLES WITH THE BOBBIN THREAD | |
| REMAINING AMOUNT DETECTING DEVICE | 121 |
| 12. HOW TO ADJUST THE FOOT PEDAL | 122 |
| 13. ERROR CODE LIST | 124 |
| 14. INPUT NUMBER TABLE | 136 |

I . CAUTIONS BEFORE OPERATION

Following items have to be checked every working day before the operation of the machine and before the start of work hours.

- 1. Ascertain that the sewing machine is filled with the predetermined amount of oil.**
- 2. Never operate the machine unless the lubricating part in the hook has been filled up with oil.**
- 3. Ascertain that the pressure gauge indicates the designated air pressure of 0.5 MPa.**

*** (This is necessary particularly when the compressor is stopped for a lunch break or the like.)**

If the compressed air pressure is equal to or less than the designated value, troubles such as interference between the parts can occur. It is therefore necessary to carefully check the compressed air pressure.

- 4. Check whether the needle thread/bobbin thread need to be replenished.**
- 5. To perform sewing immediately after turning ON the power switch, perform trial stitching first, then proceed with sewing of actual products after the test sewing.**
- 6. In order to prevent the optical fiber sensor of the bobbin thread remaining amount detecting device from showing a detecting failure, be sure to clean thread waste around the hook using an air gun once or more times a day.**
- 7. In order to protect the flap sensor from showing a detecting failure, be sure to clean dust on the reflecting tapes of the folding plate and the left flap base using an air gun once or more times a day.**

II. CONFIGURATION OF THE MACHINE

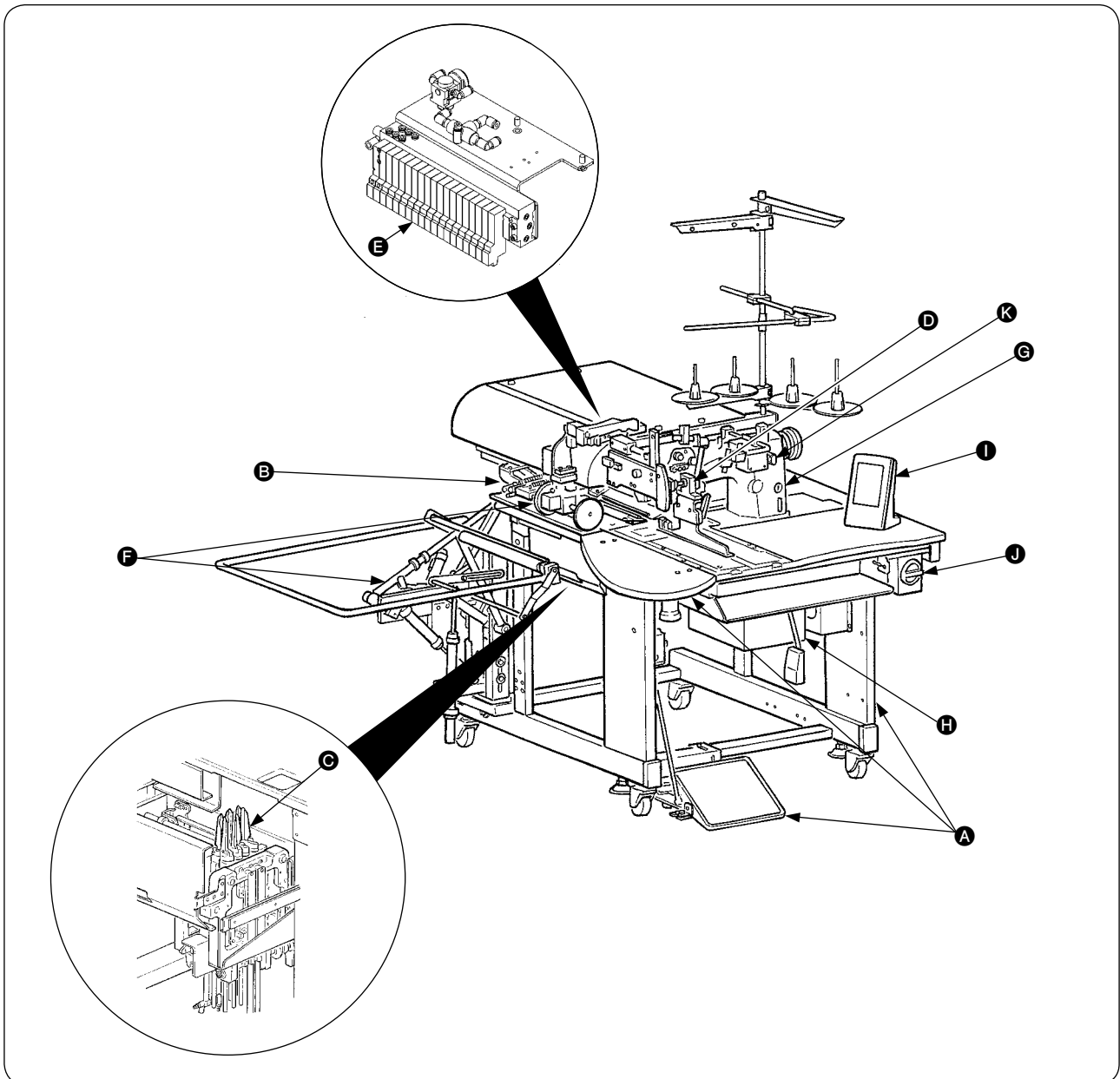

The APW-896 consists mainly of the following units.

- Ⓐ Frame and structural components (Framesewing table, covers, foot switch, etc.)
- Ⓑ Clamp foot unit and feed mechanism
- Ⓒ Corner knife unit
- Ⓓ Binder unit (Binder components and its driving components)
- Ⓔ Pneumatic control unit (Pneumatic control devices and pipings)
- Ⓕ Stacker unit (Optional)
- Ⓖ Sewing machine head
- Ⓗ Electric control unit (Control panel)
- Ⓘ Operation panel
- ⓵ Power switch (Also used as the emergency stop switch)
- ⓷ Temporary stop switch

With this machine consisting of the aforementioned 11 units, you can do desired welting work simply by setting materials (garment body, interlining piece, welting patch, etc.) in place and operating the switches on the operation panel.

In addition, when temporary stop switch ⓷ is pressed during operation of the device, the device stops.

III. SPECIFICATIONS

1. MECHANICAL SPECIFICATIONS

| | | |
|----|----------------------------------|---|
| 1 | Sewing machine | LH-896 model of 2-needle, lockstitch machine with a center knife |
| 2 | Sewing speed | 3,000 sti/min (max.) |
| 3 | Stitch length | Lockstitch: 2.0 to 3.4 mm (standard: 2.5 mm) Condensation stitch: 0.5 to 1.5 mm (standard: 1.0 mm) Back tack stitch: 0.5 to 3.0 mm (standard: 2.0 mm) Condensation/Back tack stitch selectable |
| 4 | Types of welt | Parallel double welt, parallel single welt slant double welt, slant single welt } Each with flap or without flap |
| 5 | Pocket lip size (Welt length) | Possible to set in increments of 0.1 mm within the range of 18 mm (min.) to 220 mm (max.) * Parallel flap : Min. 47.5 mm * Slant flap : Dependent on deflection amount (Reference) 20 mm gauge, deflection amount 20 mm, back-tuck 7.5 mm → Min. 67.5 mm |
| 6 | Welting width (Needle gauge) | 8, 10, 12, 14, 16, 18 and 20 mm * However, for SA117 with dart stretcher, 8, 10, and 12 mm For SA122 with breast pocket, 8, 10 and 12 mm For SA125 with zipper attachment, 16 mm, 18 mm, 20 mm |
| 7 | Needles | ORGAN DP X 17 #14 to #18 (standard #16) |
| 8 | Thread | Spun thread #60 (Recommended) |
| 9 | Hook | Full rotary, vertical-axis, self-lubrication hook |
| 10 | Thread take-up lever | Slide thread take-up lever |
| 11 | Needle bar stroke | 33.3mm |
| 12 | Cloth feed mechanism | Driven by stepping motor |
| 13 | Control | By a micro-computer |
| 14 | Safety mechanism | Machine operation is automatically stopped if the cloth feed mechanism error detector, the needle thread breakage detector or any of the various safety devices is actuated. |
| 15 | Lubricating oil | JUKI New Defrix Oil No. 1 |
| 16 | Operating air pressure | 0.5MPa |
| 17 | Air consumption | Approx. 40dm ³ /min.(ANR) |
| 18 | Dimensions of machine | Width : 1,095 mm (1,580 mm - when including the stacker) Length : 1,500 mm Height : 1,165 mm (1,800 mm - when including the thread stand) |
| 19 | Weight | 238.5kg |
| 20 | Noise | - Equivalent continuous emission sound pressure level (L _{pA}) at the workstation : A-weighted value of 80.0 dB; (Includes K _{pA} = 2.5 dB); according to ISO 10821- C.6.3 -ISO 11204 GR2 at 3,000 sti/min for the sewing cycle, 4.8s ON. (Pattern : No.1, Jump feed speed of clamp foot : Max speed) |

2. ELECTRICAL SPECIFICATIONS

| | | |
|---|--|---|
| 1 | The number of independent sewing patterns that can be stored in memory | 99 (1 to 99) |
| 2 | The number of alternate sewing patterns that can be stored in memory | 20 (1 to 20) |
| 3 | The number of cycles that can be stored in memory | 20 (1 to 20) |
| 4 | Input power: Single phase/3-phase | 200 to 240V 50/60 Hz (Optional 380V) Voltage fluctuation : Within + 10% of the rated voltage |
| 5 | Power consumption | 350VA |

IV. INSTALLATION

1. REMOVING PACKING MATERIALS

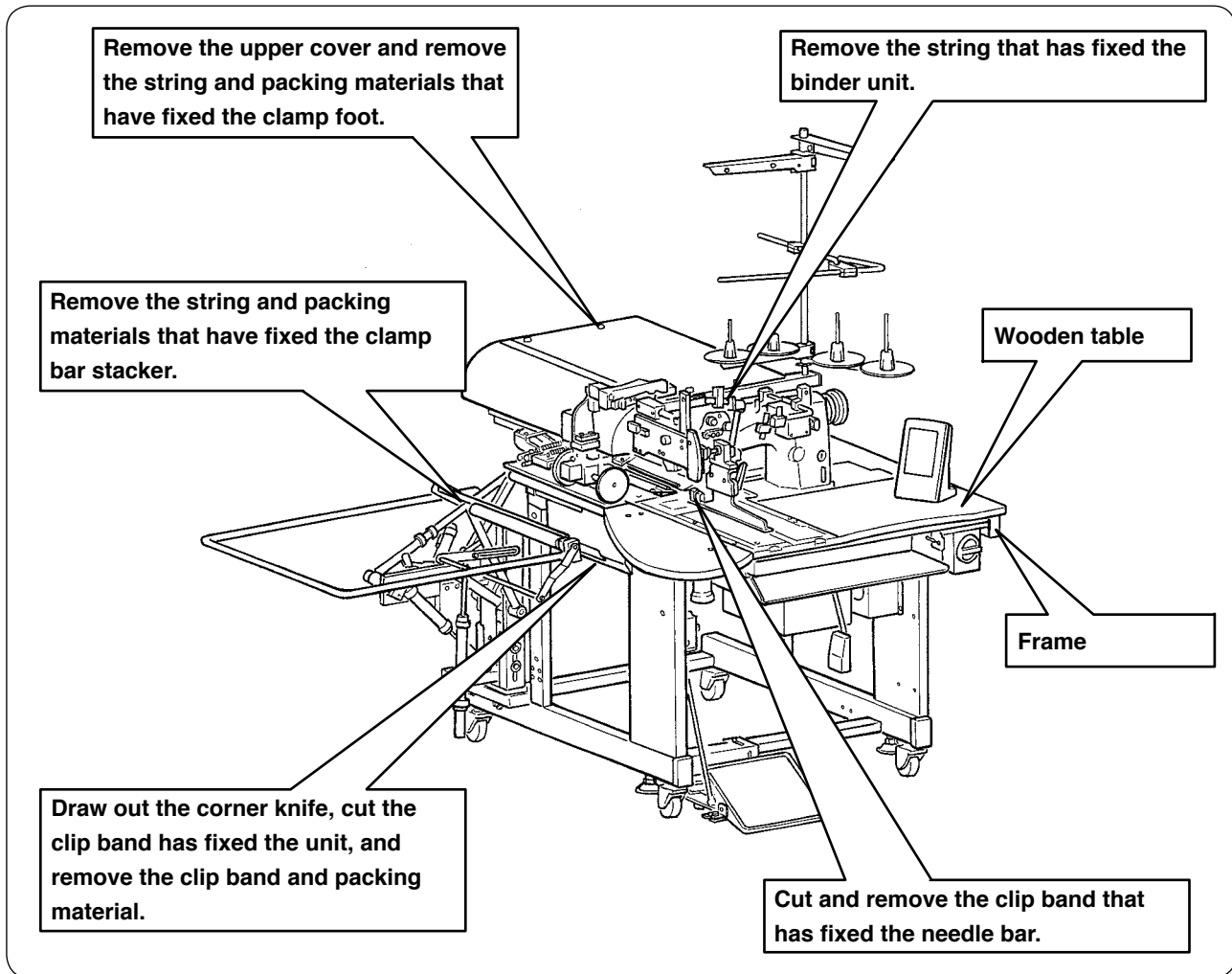

When lifting the machine, hold the frame without holding the wooden table.

2. SECURING THE MACHINE



CAUTION :

To prevent a fatal accident, lower and fix adjust bolts ② (4 places) located at the side of caster ① after moving the machine to the level and stabilized place.

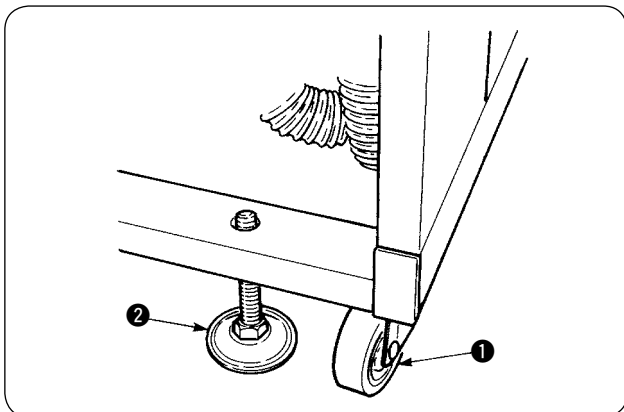

3. CONNECTING THE FOOT PEDAL



CAUTION :
When installing the pedal, perform the work paying attention to the overhead table.

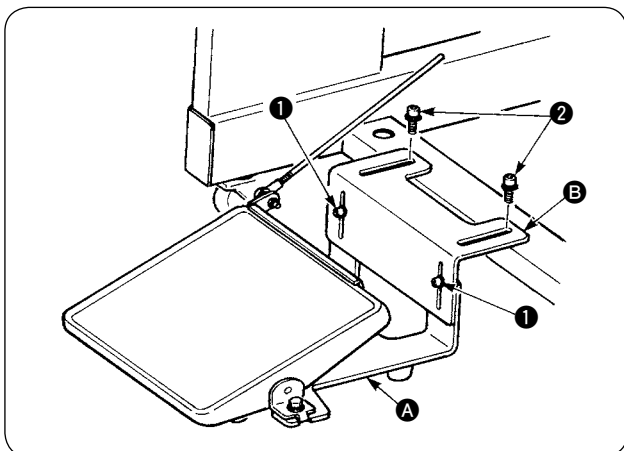

- ① Install the pedal base to the machine frame with screws ②.
- ② Connect pedal bases A and B with two screws ①.



Position of the pedal can be optionally adjusted within the range of the slot.

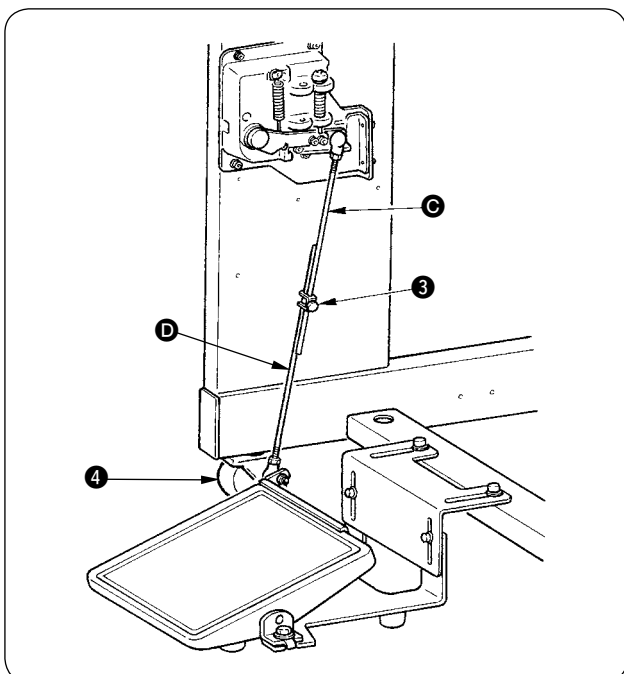

- ③ Connect the connecting rods with fixing screw ③.



1. When connecting, do not connect the rods with connecting rod C on the sensor side pulled downward,
2. Install so that connecting rod on the pedal side D and the caster 4 do not interfere with each other within the range of pedal operation.

4. CONNECTING THE AIR COUPLER

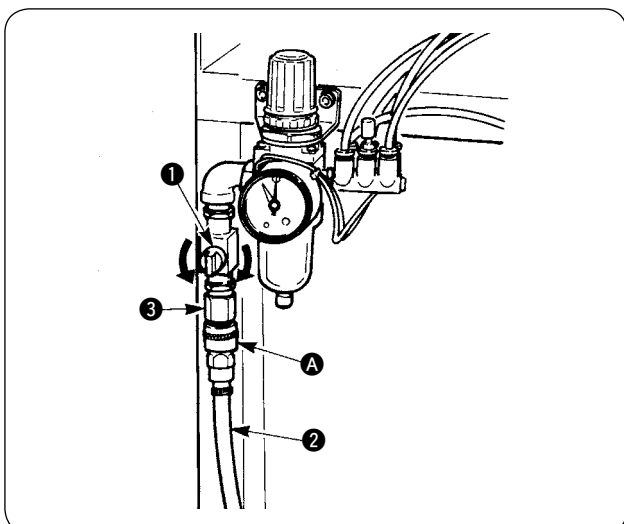

Connect one end of air coupler A supplied with the machine as an accessory to air hose ②. Then connect the other end to coupler ③ on the main unit side.



- Connect coupler A to the main unit with air cock ① closed, then carefully open air cock ① to allow the compressed air to be supplied.
- Make sure that the pressure gauge of the regulator reads 0.5 MPa.

5. CONNECTING THE POWER PLUG



CAUTION :

To prevent possible accidents caused by leakage or dielectric strength, an appropriate power plug shall be installed by a person who has an expert knowledge of electricity. Be sure to connect the power plug to the receptacle that is well grounded.

Connection of the power plug to the power depends on the specifications of the product. Adjust the power plug to the power specifications to connect.

① **In case of the product of single-phase, 200 to 240V specifications :**

Connect the sky-blue and brown wires of the power cord to the power terminal (AC200 to 240V) and the yellow/green wire to the ground (earth) terminal respectively.

② **In case of the product of 3-phase, 200 to 240V specifications :**

Connect the red, white and black wires of the power cord to the power terminal (AC200 to 240V) and the yellow/green wire to the ground (earth) terminal respectively.

③ **In case of the product with the optional high voltage transformer (with SA-128) :**

Connect the black wires (3 pieces) of the power cord to the power terminal (AC380 to 415V) and the yellow/green wire to the ground (earth) terminal respectively.

It is possible to connect to 380/400/415V by setting of the input tap of transformer (standard setting at the time of delivery : 380V).



This product performs operation by the single-phase connection for 3-phase 380/400/415V.

[Caution when changing the power source of the high voltage optional transformer]

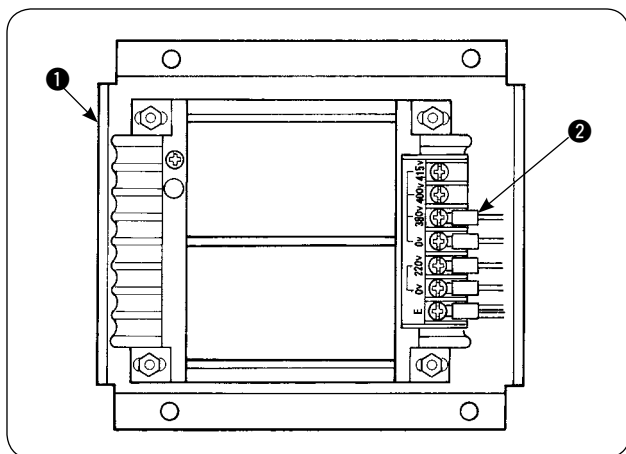

When using high voltage optional transformer

① with the input voltage of 400V or 415V, it is necessary to replace input power source cord ② of high voltage optional transformer ①. Change power source input cord ② (sky blue) that is connected to 380V to the connection of 400V or 415V.



To prevent accidents, perform the work after leaving the sewing machine alone more than 4 minutes in the state that the power switch is turned OFF and the power cord is drawn out.

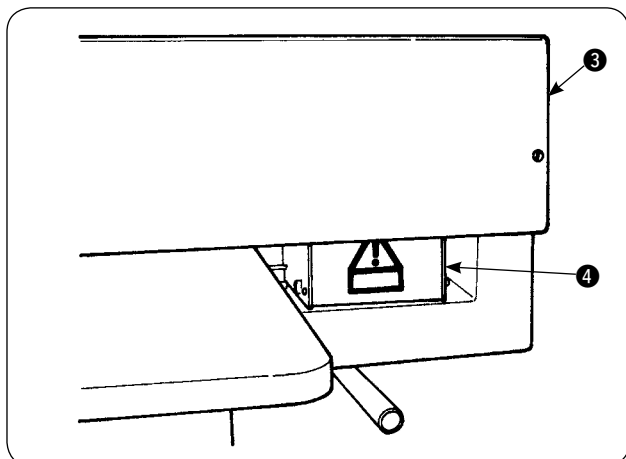

High voltage optional transformer ① is set on the rear side of the table.

When performing changeover of voltage, remove transformer box ④ after removing top cover ③.

6. ASSEMBLING THE THREAD STAND AND ATTACHING IT TO THE MACHINE

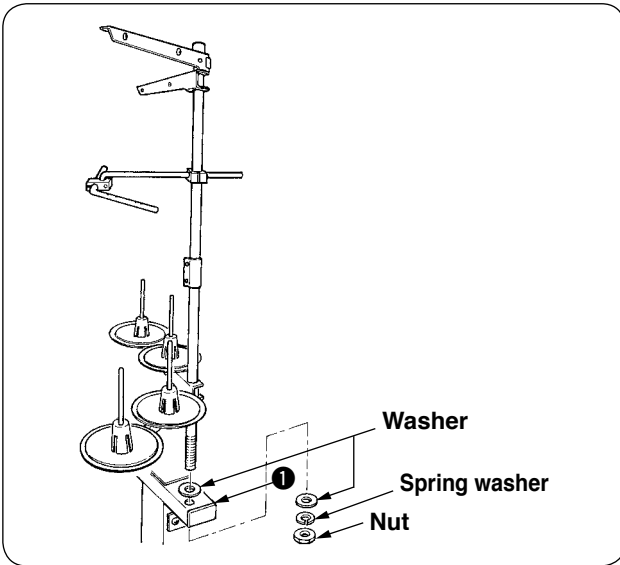

Putting nut and washer between main unit frame ① and fix the thread stand as illustrated in the left-hand figure.

7. INSTALLING SP-46 (CLAMP BAR STACKER) (OPTIONAL PART NO. : 40058952)

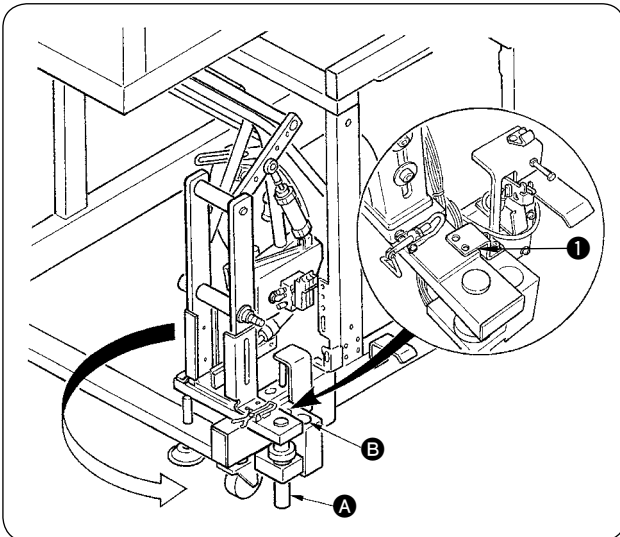

Clamp bar stacker is delivered in the state that it is fixed in the frame at the time of delivery with the clamp bar stacker mounted. It is necessary to change the installing position to the normal using position.

- ① Remove stacker fixing plate ①.
- ② Turn the whole stacker in the direction of the arrow and take it out from inside of the frame.
- ③ Change stacker turning shaft ① section to stacker base hole ②.



At this time, take care to prevent the stacker cord, the air piping, etc. from being caught.

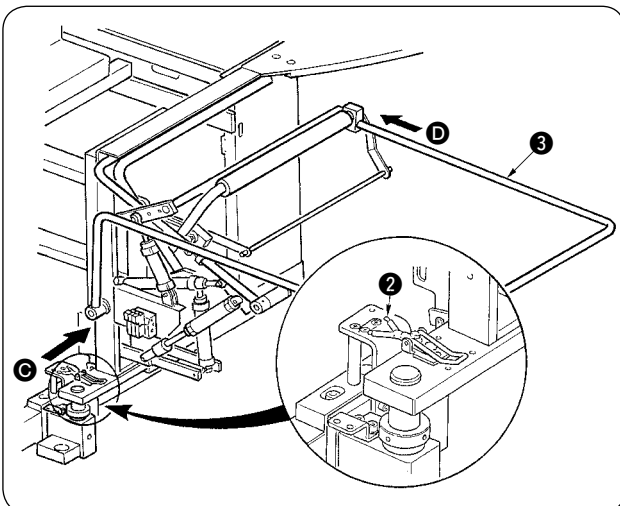

- ④ Lock the whole stacker with hinge ③.
- ⑤ Enter safety bar ④ from ⑤ and ⑥ directions and fix it at the position where is almost parallel to the floor.



At this time, confirm that air is being supplied.

8. INSTALLING SP-47 (ROLLER STACKER) (OPTIONAL PART NO. : 40058953)

(1) Adjusting the position

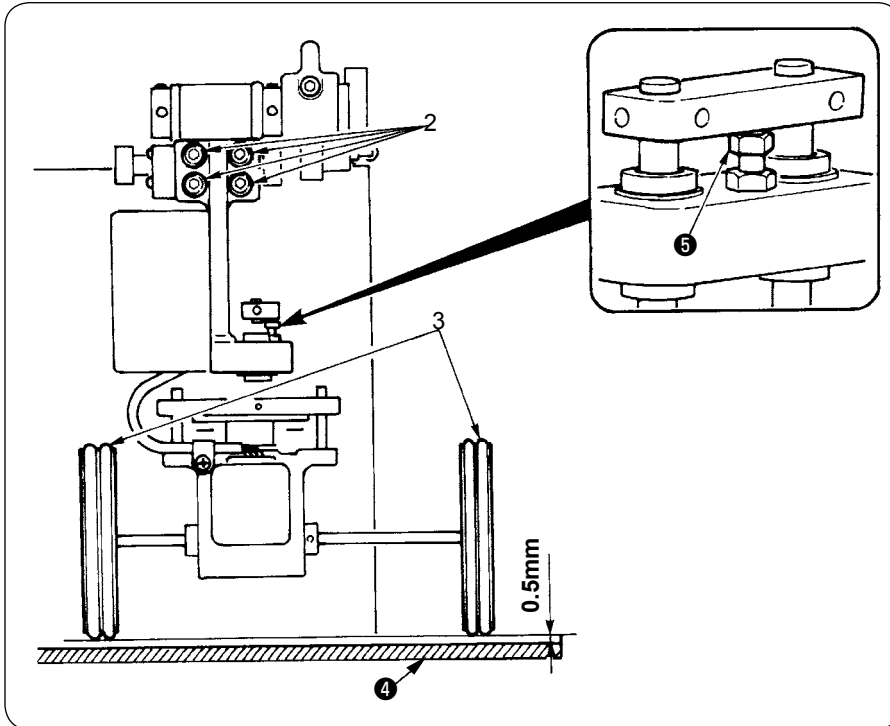

- ① Confirming parallelism
Make sure that stacker table ④ and rubber roller ③ are installed parallel with each other.
If not, loosen four setscrews ② to adjust.
- ② Confirming the clearance
Make sure that the clearance between stacker table ④ and rubber roller ③ is approximately 0.5 mm.
If it is not approximately 0.5 mm, loosen nut ⑤ to adjust.

(2) Maintenance

(Working state)

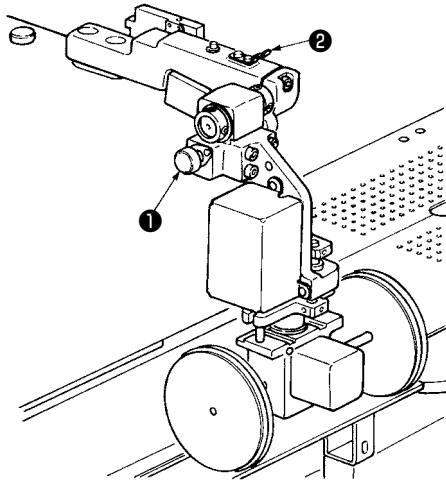

When the roller stacker is not used or adjusting the corner knife, the roller stacker can be turned upward with the procedure below.

Pull release lever ① . Lift up the roller section to thrust pin ③ into fixing spring ② , then bring them into locked state (see Fig. 1). This puts the sewing machine in standby state.

Fig. 1

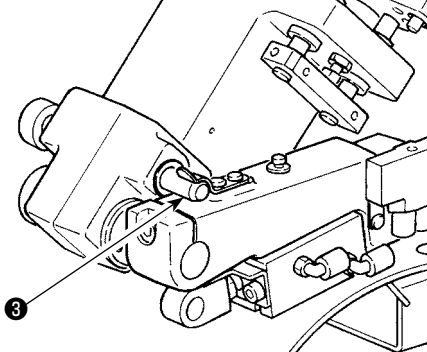

(Waiting state)

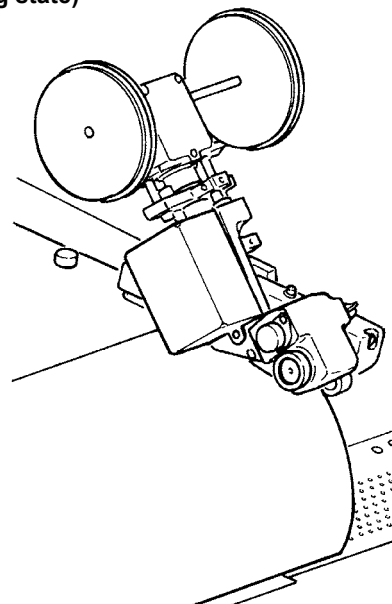

9. REMOVING THE HEAD FIXING PLATE

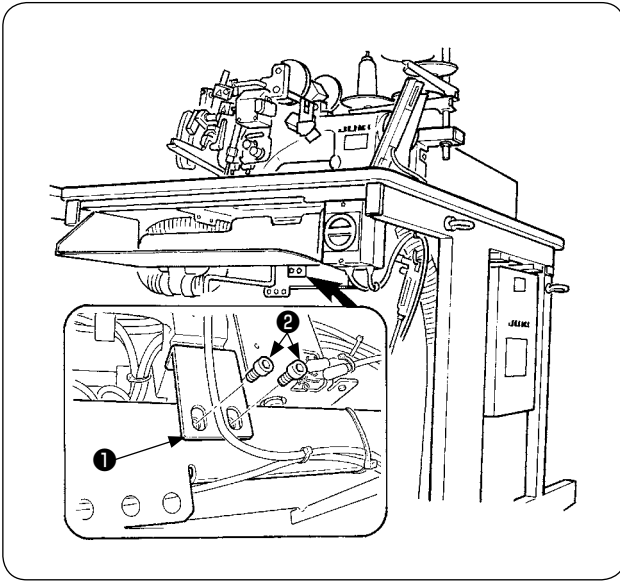

Remove fixing screws ② of head fixing plate ①.



Be sure to fix the machine and the frame when performing re-transportation.

10. INSTALLING THE SUB-TABLE

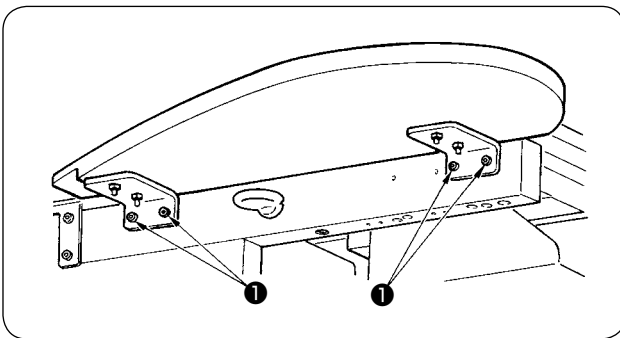

Install the sub-table with four screws ① as shown in the figure.



At this time, fix the sub-table so as to be flush with the main table.

11. INSTALLING OPERATION PANEL IP-420

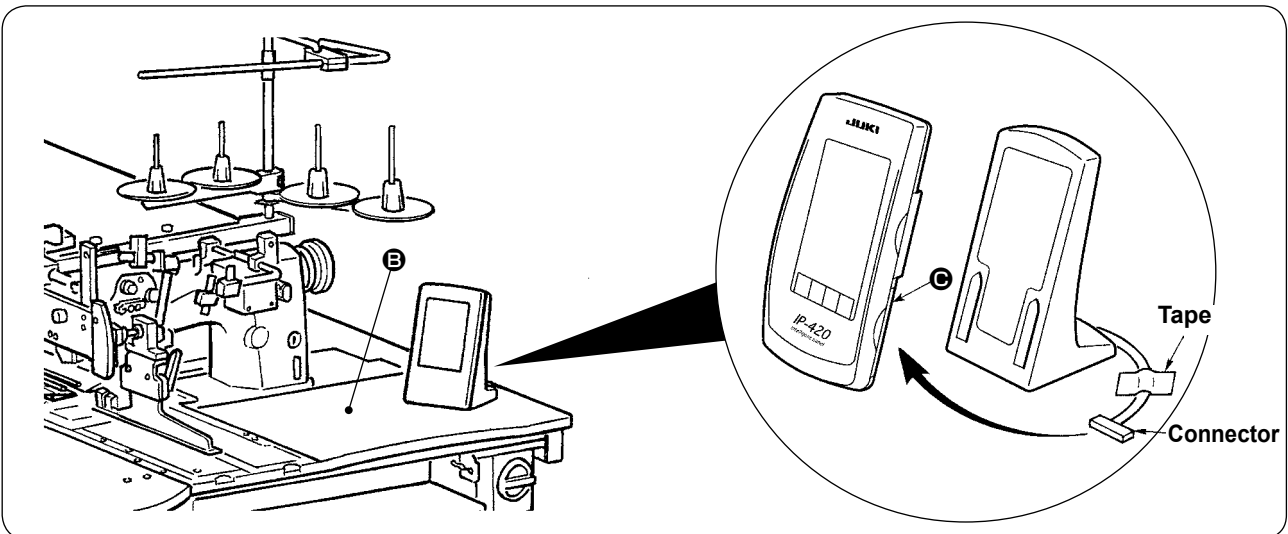

As shown in the figure above, open the lid on the right-hand section ③ of IP-420 and connect the connector which is fixed with tape to the right-hand top surface ⑤ of the table.



To prevent malfunction due to static electricity, install operation panel IP-420 on the panel base to use and do not change the position of the panel base.

12. LUBRICATING THE OIL TANK

CAUTION :



1. To prevent accidents caused by abrupt start of the sewing machine, do not connect the power plug until lubrication has been completed.
2. To prevent inflammation or rash, immediately wash the part when oil has stuck to your eyes or body.
3. If oil has been swallowed, diarrhea or vomiting may occur. Put oil to the place where children cannot reach.

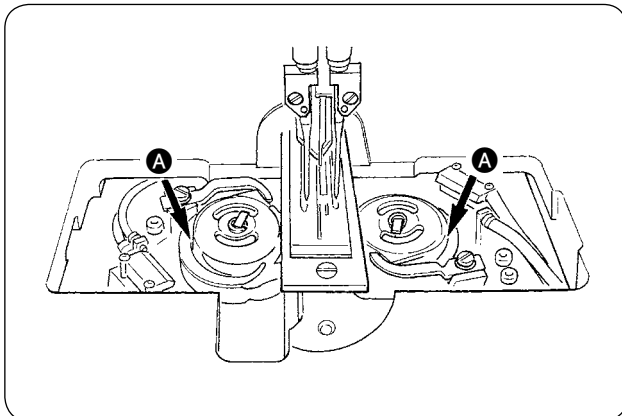
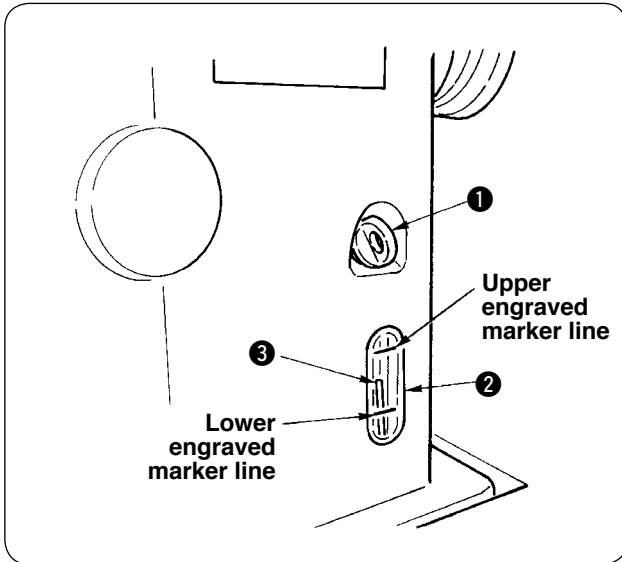

Fill the oil tank with the oil for hook lubrication before operating the sewing machine.

- ① Remove oil cap ① and fill the oil tank with JUKI MACHINE OIL No. 1 (Part No. : MDFRX1600C0) using the oiler supplied with the machine as accessories.



To prevent entering of dust, be sure to attach the cap for use.

- ② Fill the oil tank with the oil until the top end of oil amount indicating rod ③ comes between the upper engraved marker line and the lower engraved marker line of oil amount indicating window ②.

When oil amount is excessively large, oil leaks from the air hole or adequate lubrication cannot be performed. So, be careful.

- ③ When operating the sewing machine and the top of oil amount indicating rod ③ has lowered up to oil amount indicating window ②, start lubricating.



- At the time of initial filling, fill the oil tank with oil of 200cc as the standard and confirm that the oil amount indicating rod is working.
- When operating a newly installed machine or a machine which has not been used for a relatively long period of time, make the machine run at 2,000 sti/min or less for the purpose of break-in. In addition, use the machine after applying oil to races A of the right/left hooks.
- For the oil for hook, purchase JUKI MACHINE OIL No. 1 (Part No. : MDFRX1600C0).
- Be sure to fill the oil tank with clean oil.
- Never fill the oil tank with dirty oil.

13. INSTALLING SA-120 (INTERLINING SUPPLYING DEVICE) (OPTIONAL PART NO. : 40045772)



CAUTION :

Turn OFF the power before starting the work so as to prevent accidents caused by abrupt start of the sewing machine.

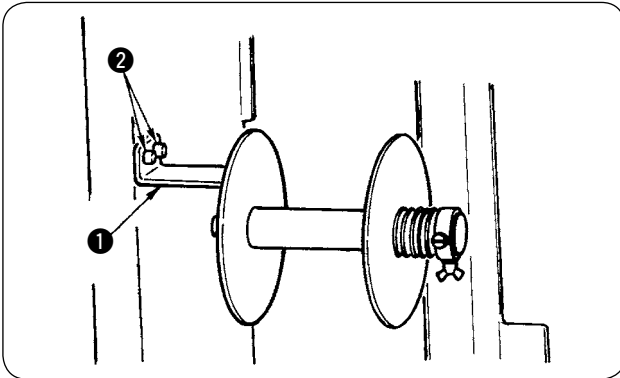

- ① Fix interlining installing plate ① to the machine frame with two screws ②.

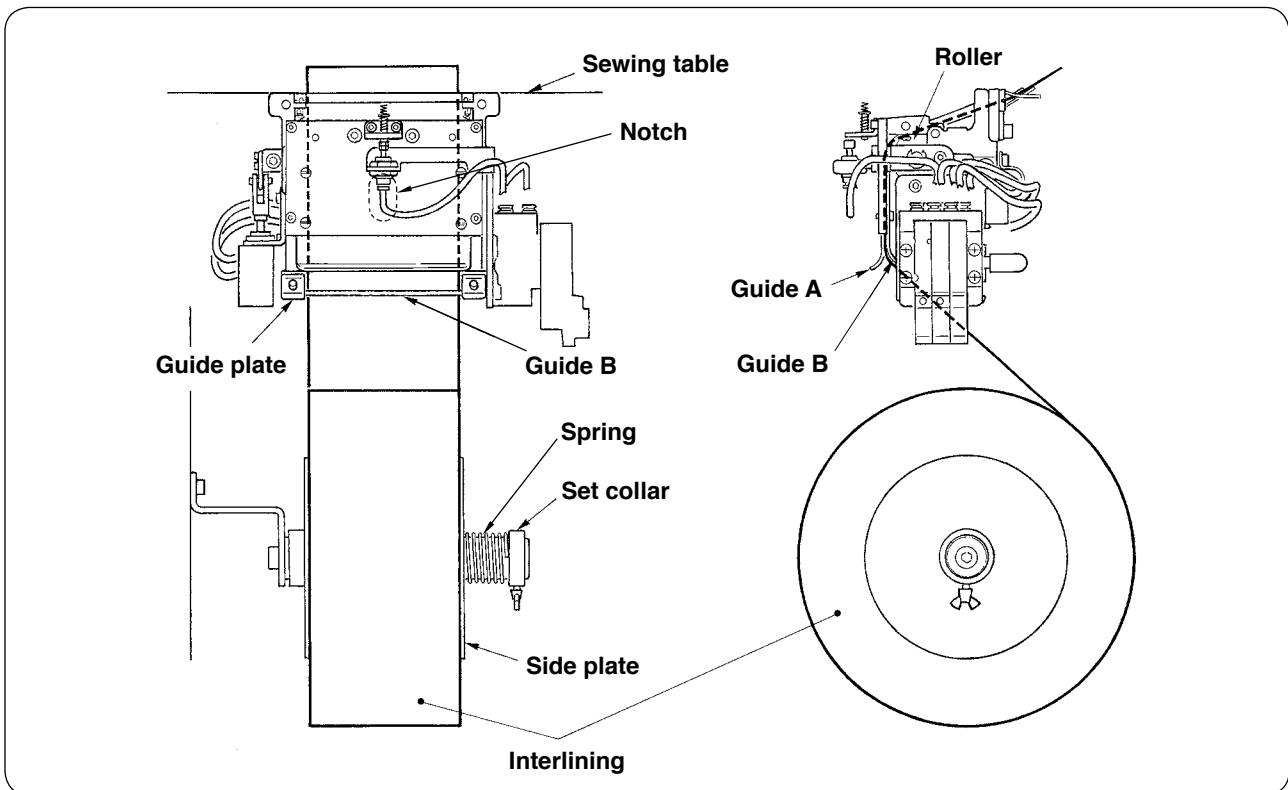

- ② Set interlining as shown in the figure above.
The roll core that can be used is 40 to 70 mm wide and 200 mm in roller diameter (max.).
- ③ Pass the interlining between guide B and guide A and roller, and route it up above the table.



Feed the interlining up to the roller section using the notch of the guide plate.

- ④ Adjust the lateral position of two guides, two guide pins and side plate (on the right) to allow the interlining to be fed straight up above the sewing table.
- ⑤ Position the set collar on the left-hand side to allow the side plate to lightly hold the interlining by spring. Then fix the set collar there.

14. ADJUSTMENT OF SA-120 (INTERLINING SUPPLYING DEVICE) (OPTIONAL PART NO. : 40045772)



CAUTION :

Turn OFF the power before starting the work so as to prevent accidents caused by abrupt start of the sewing machine.

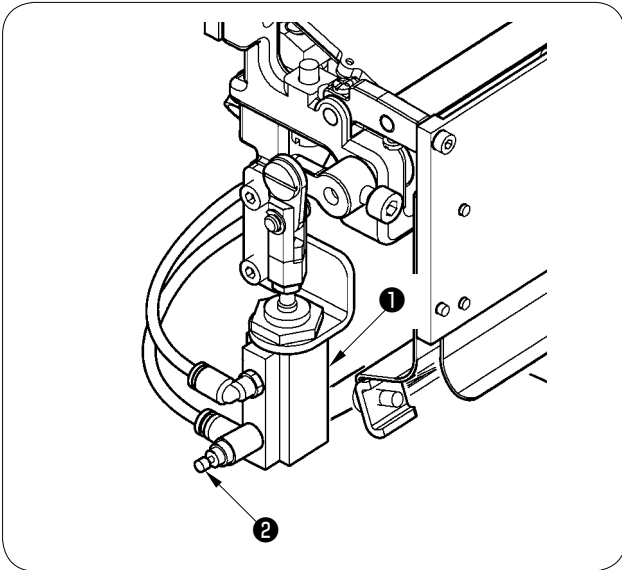

- ① Adjustment of the interlining feeding amount is performed with memory switch (U003). However, perform further fine adjustment with the speed controller ② of the interlining feeding cylinder ① .
(When tightening the speed controller ② , the amount is decreased and when loosening it, the amount is increased.)

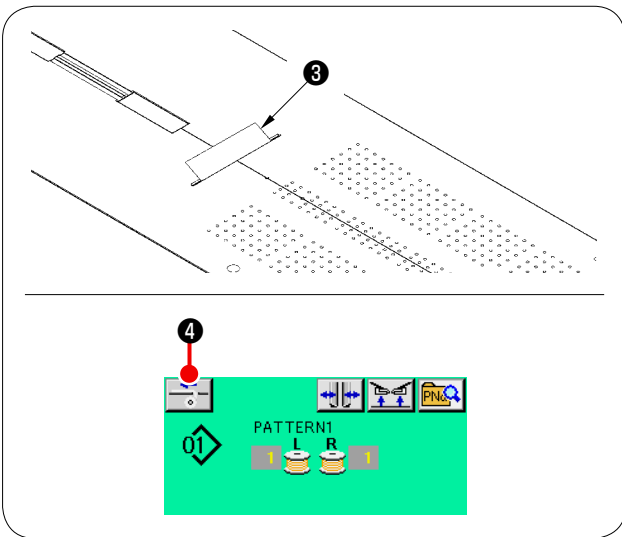

- ② When a new interlining ③ is mounted, press interlining supply button ④ , perform feeding of the trial sewing several times and use the device after confirming the feeding amount and the parallel feeding of the interlining.

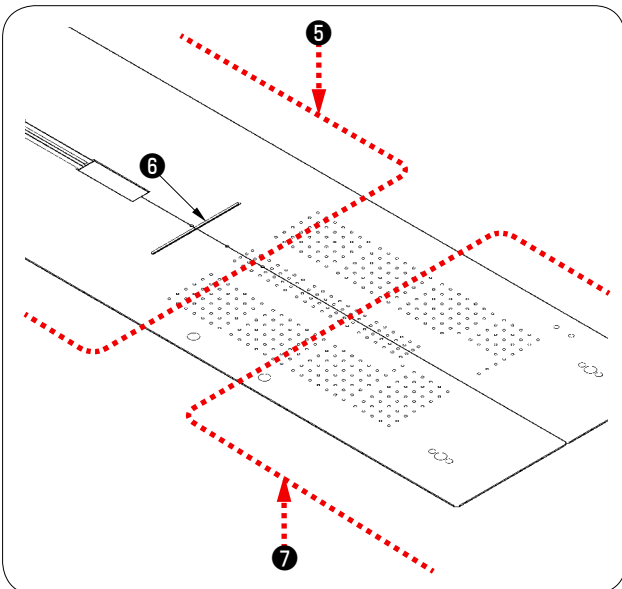

(Caution when operating)

When using the interlining supplying device with rear reference ⑤ , the interlining at the sewing start remains long since it is away from interlining outlet ⑥ . So, use the device with front reference ⑦ .



For handling the sewing tables, refer to "V-2-(2) Cautions to be taken when the sewing tables are removed" p.16.

V. PREPARATION OF THE SEWING MACHINE

1. HOW TO OPERATE THE SEWING MACHINE HEAD

(1) How to attach the needles



CAUTION :

- Turn OFF the power before starting the work so as to prevent accidents caused by abrupt start of the sewing machine.
- When replacing the needle, be careful not to allow your fingers to touch the blade section of the center knife.

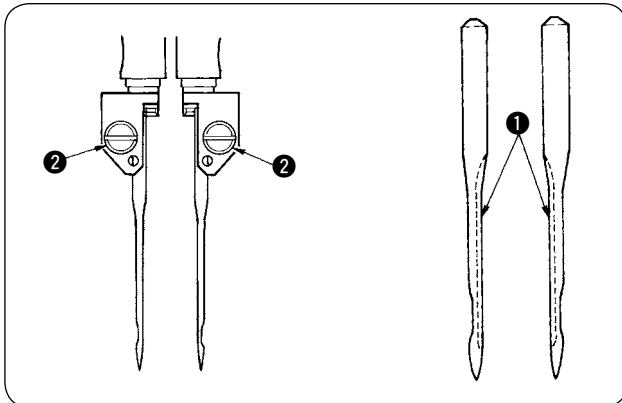

Needles used are DP X 17 #14 to #18 (standard #16). Use the specified needle.

Insert left- and right-hand sides needles as far as they will go pointing their long grooves ① at each other and tighten needle clamp screws ②.

(2) Thread used

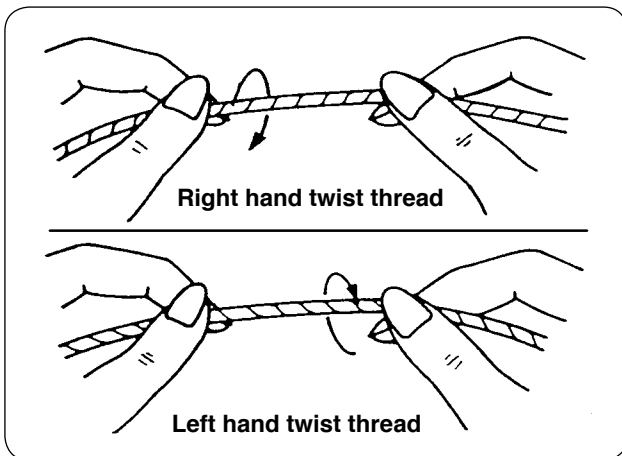

- Use the left hand twist thread for the needle thread.
- Either twist thread will do for the bobbin thread.



Use a new thread which is uniformly twisted.

(3) How to pass the needle thread



CAUTION :

Turn OFF the power before starting the work so as to prevent accidents caused by abrupt start of the sewing machine.

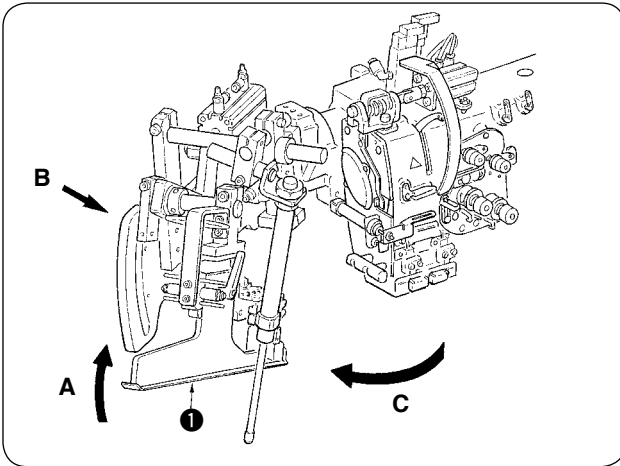

- ① Lift binder ❶ in the direction A, Hold section B by hand and turn the whole binder in the direction C.



Be sure to press section B since welting width may become improper when the binder is pressed and turned in the direction C.



Binder is locked with the ball plunger. Rather strongly turn the binder in the direction C to release the lock.

- ② Then pass needle thread in the order as shown in the figure below.

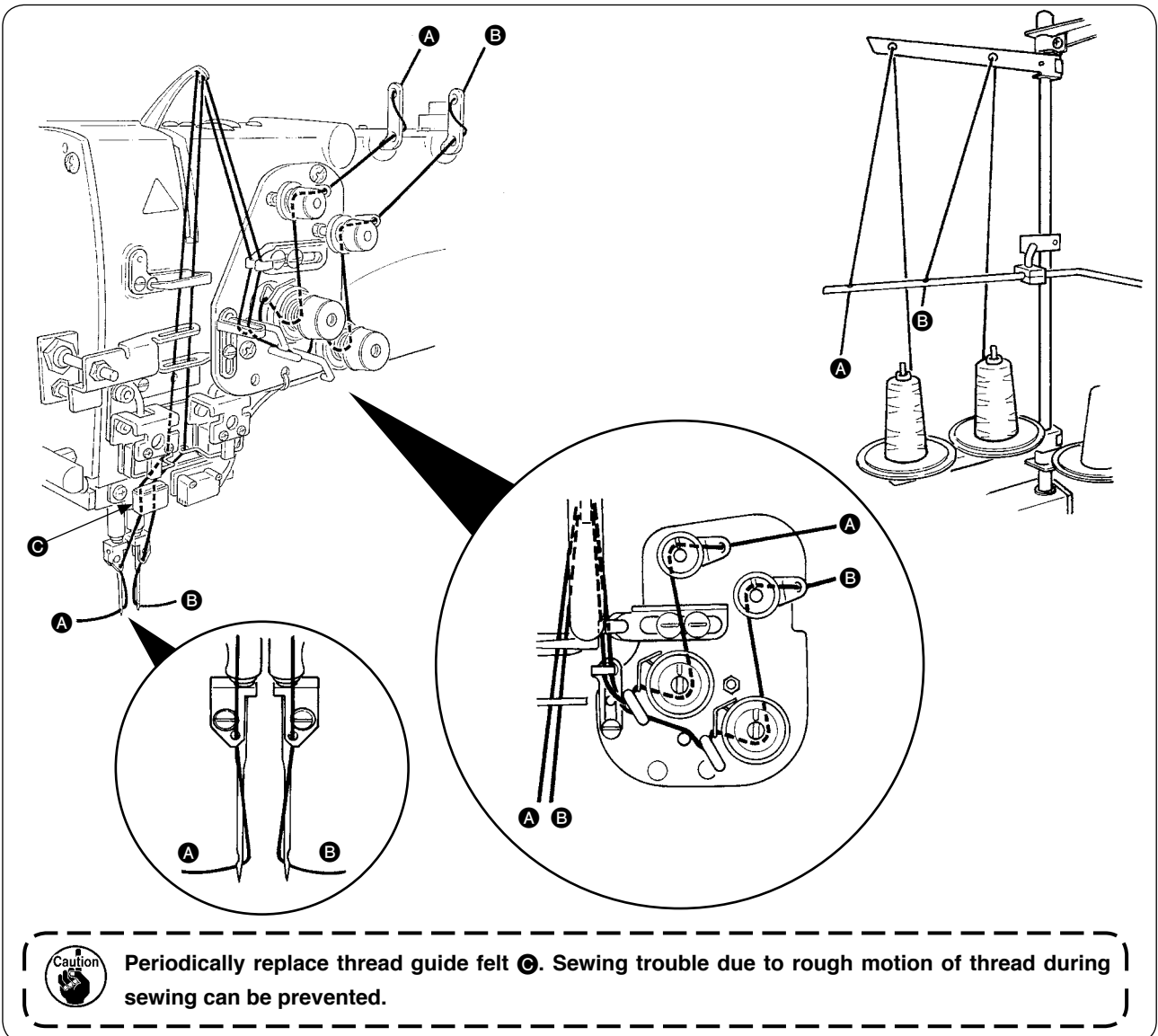

Periodically replace thread guide felt ❷. Sewing trouble due to rough motion of thread during sewing can be prevented.

Pass the needle thread in the illustrated order.

Left-hand side needle thread toward the sewing machine → A

Right-hand side needle thread toward the sewing machine → B

2. HOW TO REMOVE THE SEWING TABLE



CAUTION :

Turn OFF the power before starting the work so as to prevent accidents caused by abrupt start of the sewing machine.

(1) When replacing the bobbin thread

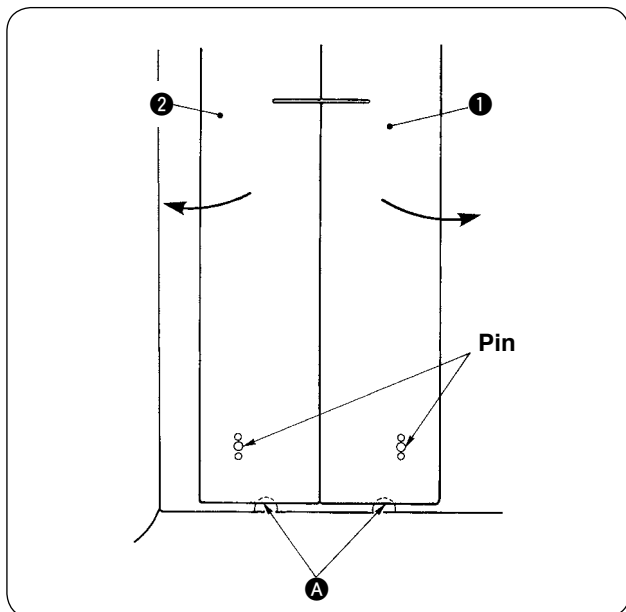

- ① Move the clamp foot to the rear end of its stroke.
- ② Insert your fingers into notches **A** in the bottom of right- and left-hand sewing tables **1** and **2**, and push up the sewing tables.
- ③ Move the tables in the direction of the arrow keeping the above state, and you can see the bobbin case.



At this time, move the sewing tables so as not to allow the sewing tables to come in contact with the needles.

- ④ After replacing the bobbin thread, return the sewing tables in place by following the above-mentioned steps of procedure in the reverse order. Now, firmly set the sewing tables on the throat plates and the pins.

(2) Cautions to be taken when the sewing tables are removed



CAUTION :

Turn OFF the power before starting the work so as to prevent accidents caused by abrupt start of the sewing machine.

When you remove the sewing tables, be sure to accurately set them by following the points below.

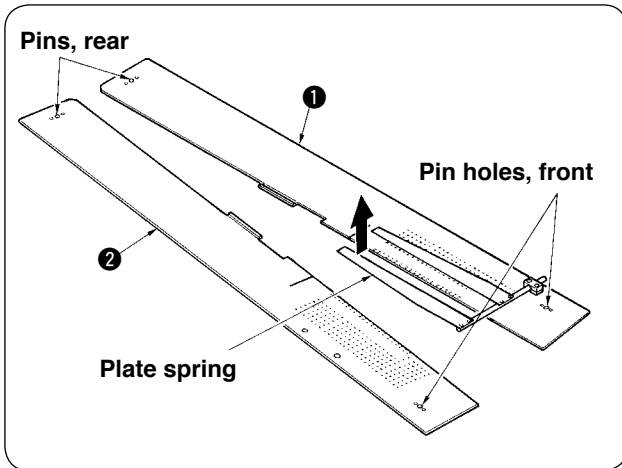

- ① Securely fit the pins, rear (left) (right) over the pin holes.
- ② Securely fit pin holes, front (left) (right) over the pins.



1. In case of the machine provided with SA-120 (automatic interlining supplying device), return the sewing tables to their home positions while lifting the sewing tables so that the plate spring section is not bent.

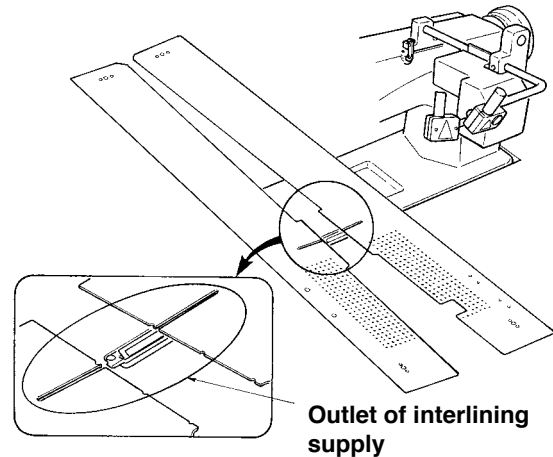

2. In case of removing the sewing tables with the types below, take care not to bend pocket bag clamping device and interlining clamping device.

① Pocket bag clamping device (standard)

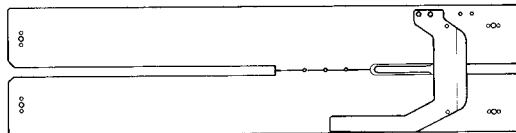

② Pocket bag clamping device (for interlining supply)

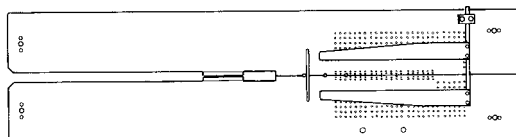

3. HOW TO WIND THE BOBBINS



CAUTION :

To prevent damage, avoid contact with bobbins while the machine is in operation.

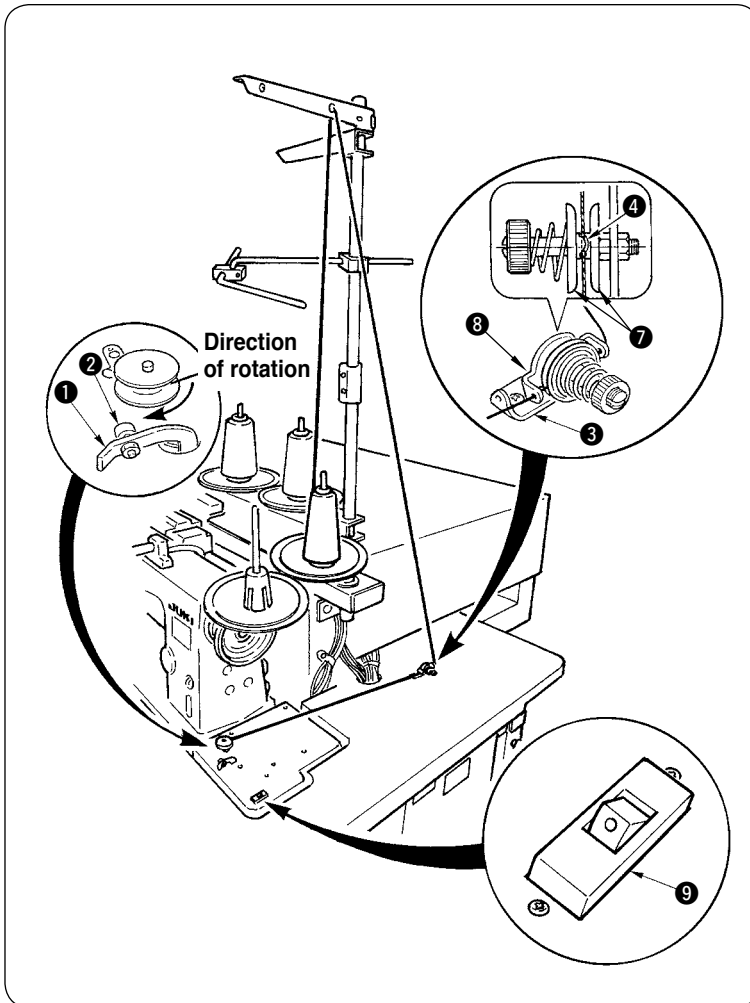

- ① Put bobbin into the thread winder shaft until it will go no further.
- ② Pass thread through thread guide plate ⑧, open thread tension disk ⑦ and put the thread into the slit of thread tension rod ④.
- ③ Pass thread in the order as shown in the figure, and wind the thread onto bobbin by four or five turns. (The direction of the arrow corresponds to the direction of rotation of the bobbin.)
- ④ Press bobbin thread guide ① and the bobbin rotates.
- ⑤ The thread winder will automatically stop as soon as it has wound up the bobbin to a predetermined amount.

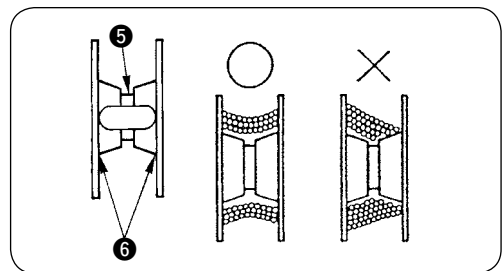

1. If you want to wind a bobbin, start winding it from recess ⑤ as illustrated in the figure above. If you start to wind a bobbin from portion ⑥, the detection of run-out of bobbin thread will fail to be performed normally.
2. To ensure the appropriate remaining amount of bobbin thread, it is important to wind the bobbin uniformly. Be sure to check that the bobbin is uniformly wound particularly at the start of bobbin winding.
If the bobbin fails to be uniformly wound with thread, properly adjust the lateral position of tension post socket ③.
3. It is most suitable to wind the bobbin with thread to approximately 80% of the outer diameter of the bobbin. The winding amount can be adjusted with winding amount adjustment screw ②.
4. Do not press lever ① except when winding bobbin thread. Motor continues to run and trouble will be caused.
5. When abnormalities such as overload of the thread winding motor, etc. are detected, thermal switch ⑨ is shut off. When thermal switch is shut off, turn ON thermal switch ⑨ again after turning OFF it to return.

4. HOW TO THREAD THE BOBBIN CASE

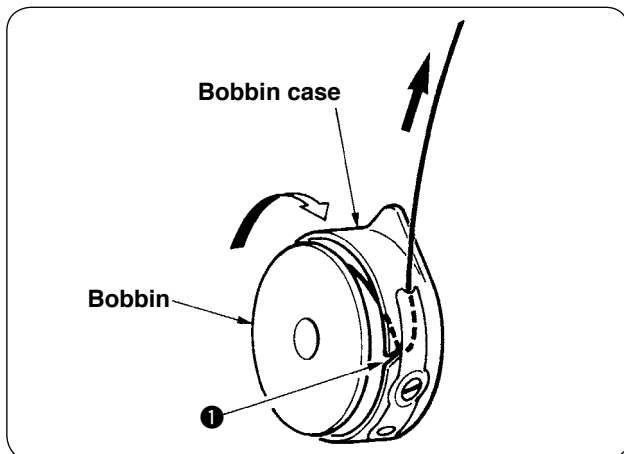

- ① Hold in hand a bobbin in the way that it spins clockwise and put it into the bobbin case.
- ② Pass the thread through slot ① in the bobbin case.
- ③ Pull the thread to pass it under the tension spring.

5. HOW TO INSTALL THE BOBBIN CASE



CAUTION :

Turn OFF the power before starting the work so as to prevent accident caused by abrupt start of the sewing machine.

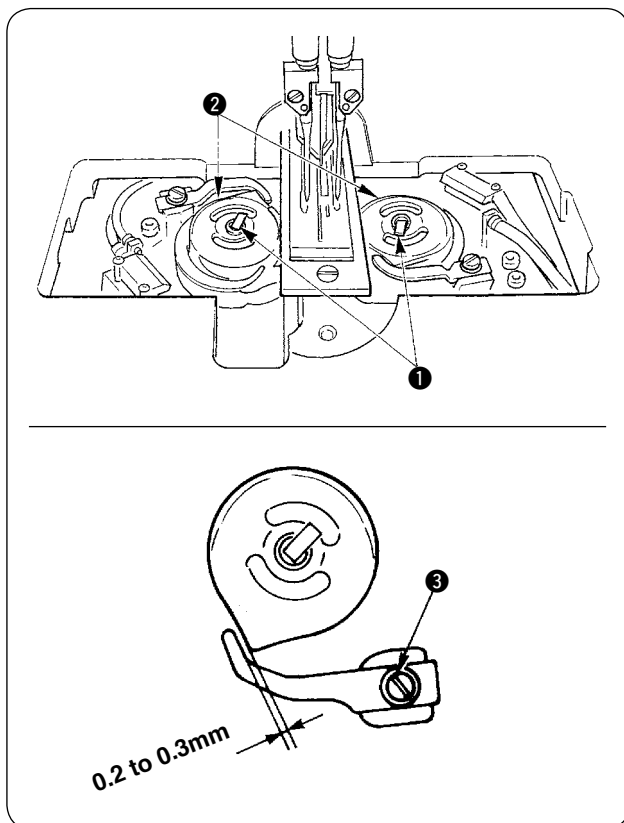

- ① Raise hook levers ① and take out the bobbin cases together with the bobbins.
- ② When fitting, fit the bobbin cases into the hook driving shaft and tilt levers ①.



When bobbin cases, left and right, ② are replaced, make sure that the clearance between the opener which is extremely receded and the bobbin case is 0.2 to 0.3 mm. If the clearance is not 0.2 to 0.3 mm, loosen setscrew ③ and adjust it.

6. HOW TO ADJUST THE THREAD TENSION

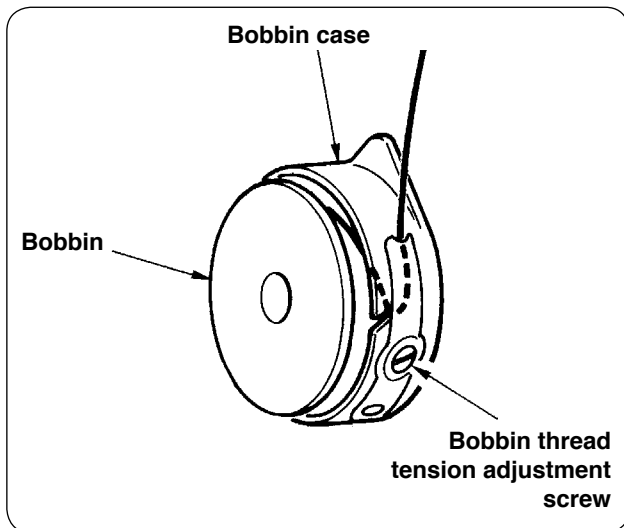

- ① Adjusting bobbin thread tension
Turn bobbin thread tension adjustment screw clockwise to increase the bobbin thread tension or turn the screw counterclockwise to decrease it.

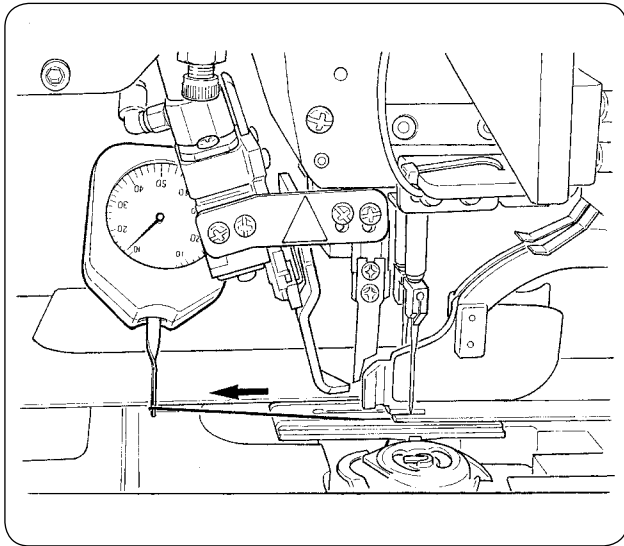

As shown in the left-hand figure, standard bobbin thread tension is 0.25 to 0.35N when measuring with the tension gauge.

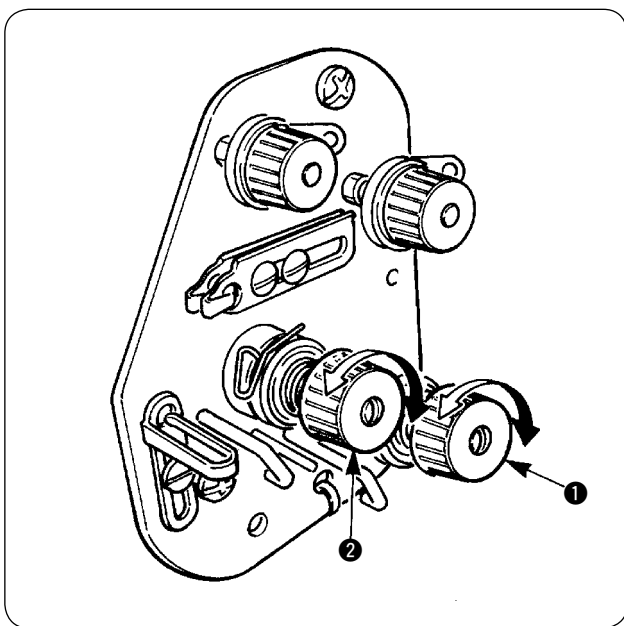

- ② Adjusting needle thread tension
First, adjust the right- and left-hands bobbin thread tension.
Then in accordance with the bobbin thread tension obtained, adjust the right- and left-hand sides needle threads tension appropriately by turning thread tension adjustments nuts ① and ② respectively. Turning the nuts clockwise will increase the thread tension or turning them counterclockwise to decrease it.

7. SETTING THE MATERIAL TO BE SEWN

(1) Setting a garment body

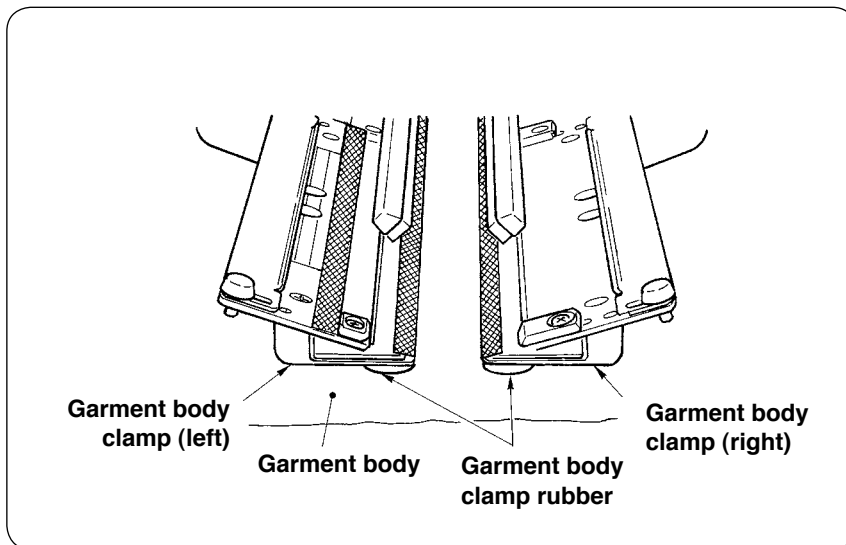

Use a garment body that is larger than the garment body clamp rubber piece adhered under the right and left garment body clamps.

If a garment body of which size is smaller than the garment body clamp rubber piece, the rubber piece can come off or the machine can malfunction.

If it is necessary to use a small material, mount a shim type gauge (optional) on the machine.

8. ADJUSTING THE MATERIAL GUIDE

Material guide functions to stabilize the welt patch at the edge of the machine needle.

Adjust the height and the presser pressure of material guide ① in accordance with the thickness of material.

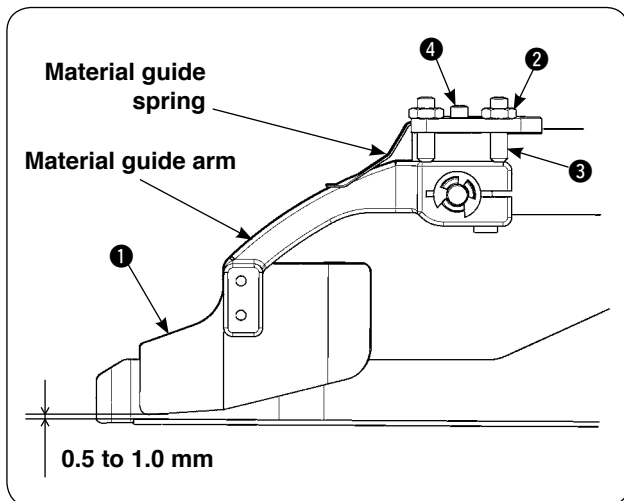

- ① The height of material guide can be adjusted by loosening nut ② and screw ③.

(Clearance between material guide and welt patch scale has been adjusted to 0.5 to 1.0 mm at the time of delivery.)

- ② Presser pressure can be adjusted with spring pressure adjust screw ④.

(Adjust the pressure so that there is no excessive resistance when the material passes.)

VI. HOW TO USE THE OPERATION PANEL

1. PREFACE

1) To use the data for APW-895/896 (EPD data) on APW-896

To use the EPD data on the APW-896, read the data into the IP-420.

Insert the relevant medium into the IP-420. Select pattern number xxx from EPD data.

2) Folder structure of the media

Store each file in the directories below of the media.

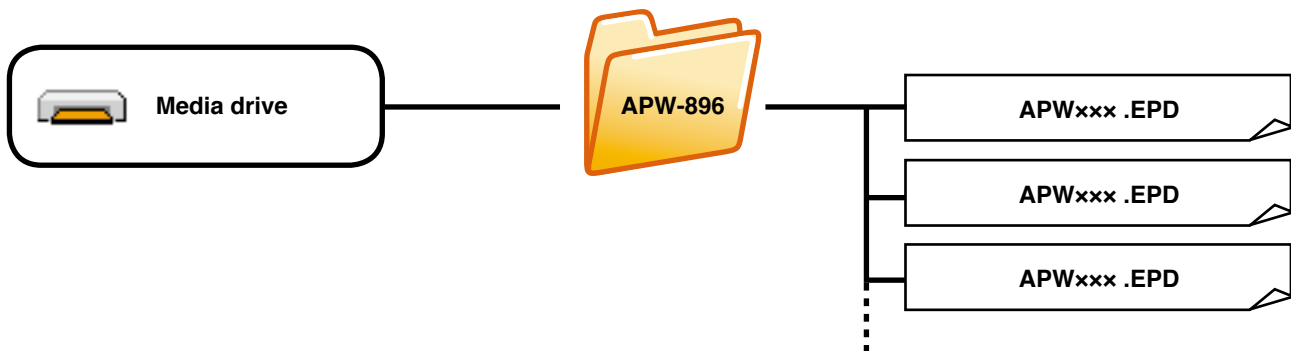

Data that are not stored in the directories above cannot be read. So, be careful.

3) CompactFlash (TM)

■ Inserting the CompactFlash (TM)

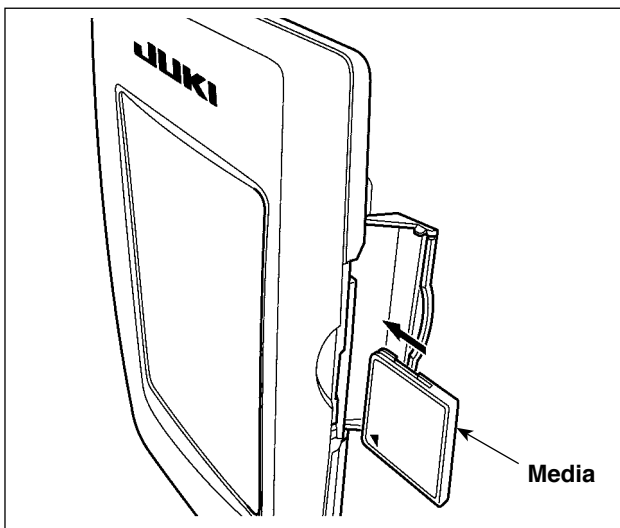

- 1) Turn the label side of the CompactFlash(TM) to this side (place the notch of the edge to the rear.) and insert the part that has a small hole into the panel.
- 2) After completion of setting of the media, close the cover. By closing the cover, it is possible to access. If the media and the cover come in contact with each other and the cover is not closed, check the following matters.
 - Check that the media is securely pressed until it goes no further.
 - Check that the inserting direction of the media is proper.



1. When the inserting direction is wrong, panel or media may be damaged.
2. Do not insert any item other than the CompactFlash (TM).
3. The media slot in the IP-420 accommodates to the CompactFlash (TM) of 2 GB or less.
4. The media slot in the IP-420 supports the FAT16 which is the format of the CompactFlash (TM). FAT32 is not supported.
5. Be sure to use the CompactFlash (TM) which is formatted with IP-420. For the formatting procedure of the CompactFlash (TM), see "[VI-17. Performing formatting of the media](#)", p.97.

■ Removing the CompactFlash (TM)

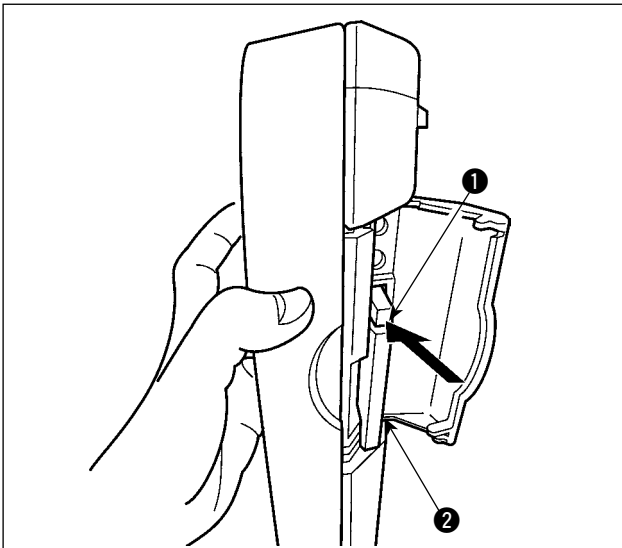

- 1) Hold the panel by hand, open the cover, and press the media ② removing lever ①. The media is eject.



When the lever ① is strongly pressed, the media ② may be broken by protruding and falling.

- 2) When the media ② is drawn out as it is, removing is completed.

5) USB port

■ Inserting a device into the USB port

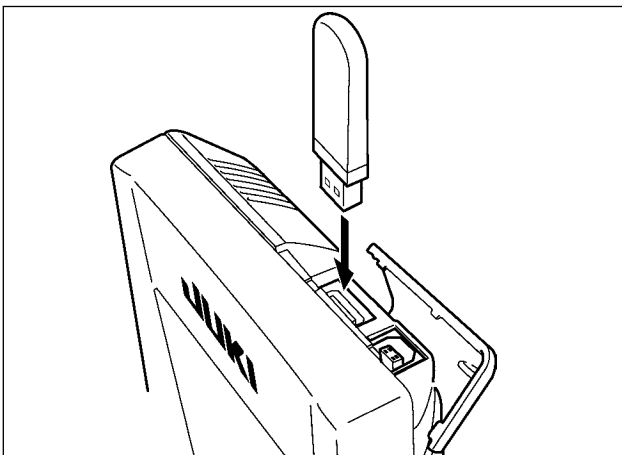

Slide the top cover and insert the USB device into the USB port. Then, copy data to be used from the USB device onto the main body.

After completion of copying the data, remove the USB device.

■ Disconnecting a device from the USB port

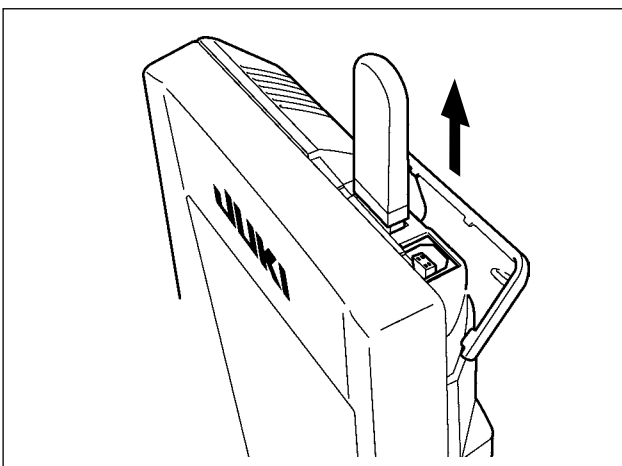

Remove the USB device. Put the cover back in place.

Cautions when using the media



- Do not wet or touch it with wet hands. Fire or electric shock will be caused.
- Do not bend, or apply strong force or shock to it.
- Never perform disassembling or remodeling of it.
- Do not put the metal to the contact part of it. Data may be disappeared.
- Avoid storing or using it in the places below.

Place of high temperature or humidity / Place of dew condensation /

Place with much dust / Place where static electricity or electrical noise is likely to occur

- ① Precautions to be taken when handling USB devices
- Do not leave the USB device or USB cable connected to the USB port while the sewing machine is in operation. The machine vibration can damage the port section resulting in loss of data stored on the USB device or breakage of the USB device or sewing machine.
 - Do not insert/remove a USB device during reading/writing a program or sewing data. It may cause data breakage or malfunction.
 - When the storage space of a USB device is partitioned, only one partition is accessible.
 - Some type of the USB device may not be properly recognized by this sewing machine.
 - JUKI does not compensate for loss of data stored on the USB device caused by using it with this sewing machine.
 - When the panel displays the communication screen or pattern data list, the USB drive is not recognized even if you insert a medium into the slot.
 - For USB devices and media such as CF cards, only one device/medium should be basically connected/inserted to/into the sewing machine. When two or more devices/media are connected/inserted, the machine will only recognize one of them. Refer to the USB specifications.
 - Insert the USB connector into the USB terminal on the IP panel until it will go no further.
 - Do not turn the power OFF while the data on the USB flash drive is being accessed.





- ② USB specifications
- Conform to USB 1.1 standard
 - Applicable devices *1___ Storage devices such as USB memory, USB hub, FDD and card reader
 - Not-applicable devices___ CD drive, DVD drive, MO drive, tape drive, etc.
 - Format supported ___ FD (floppy disk) FAT 12
Others (USB memory, etc.), FAT 12, FAT 16, FAT 32
 - Applicable medium size _ FD (floppy disk) 1.44MB, 720kB
Others (USB memory, etc.), 4.1MB ~ (2TB)
 - Recognition of drives ___ For external devices such as a USB device, the device which is recognized first is accessed. However, when a medium is connected to the built-in media slot, the access to that medium will be given the highest priority. (Example: If a medium is inserted into the media slot even when the USB memory has already been connected to the USB port, the medium will be accessed.)
 - Restriction on connection _ Max. 10 devices (When the number of storage devices connected to the sewing machine has exceeded the maximum number, the 11th storage device and beyond will not be recognized unless they are once disconnected and re-connected.)
 - Consumption current ___ The rated consumption current of the applicable USB devices is 500 mA at the maximum.

*1: JUKI does not guarantee operation of all applicable devices. Some device may not operate due to a compatibility problem.

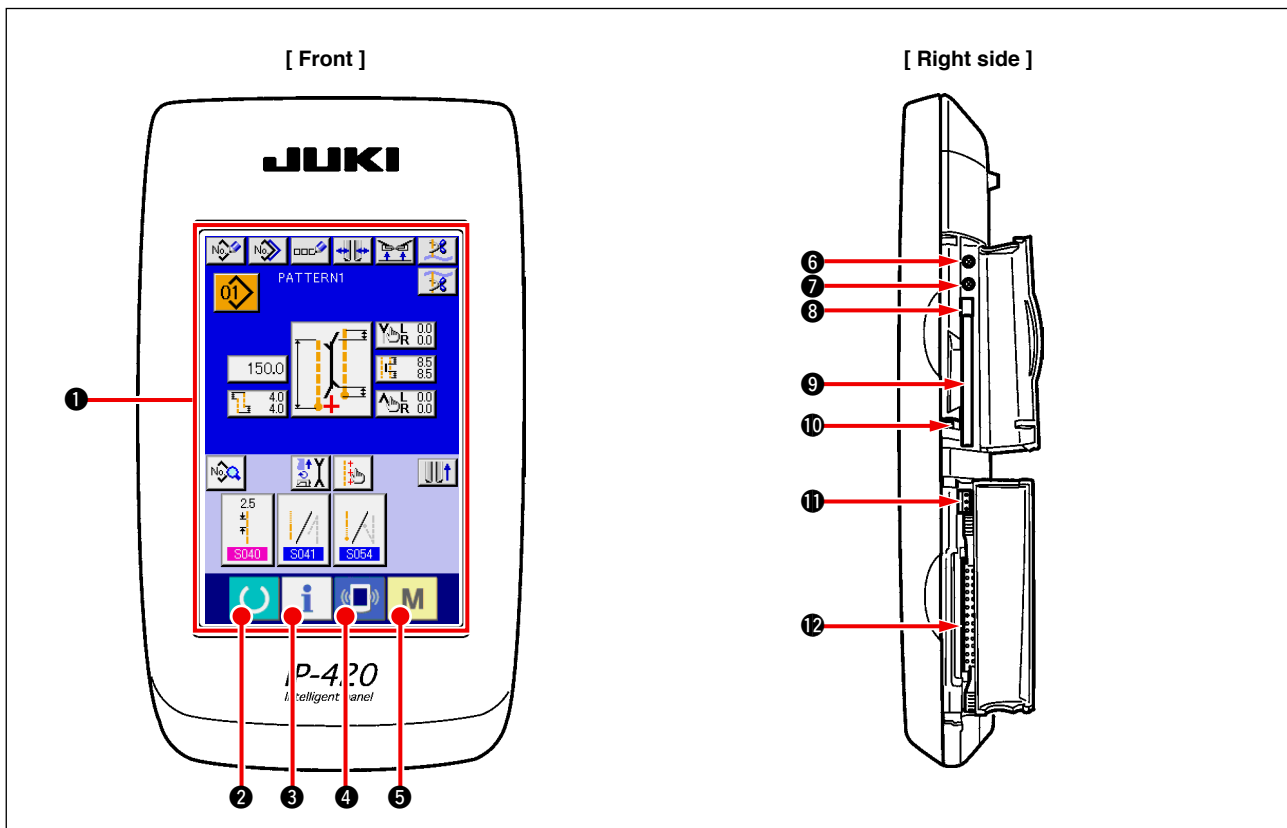
2. BASIC OPERATION OF THE OPERATION PANEL (IP-420)

(1) Configuration of IP-420









| Symbol | Name | Description |
|--------|---|--|
| ① | TOUCH PANEL, LCD display section | |
| ② |  READY key | Change-over of the data input screen and the sewing screen is performed. |
| ③ |  INFORMATION key | Change-over of the data input screen and the information screen is performed. |
| ④ |  COMMUNICATION key | Change-over of the data input screen and the communication screen is performed. |
| ⑤ |  MODE CHANGEOVER key | Change-over of the data input screen and the mode change-over screen which performs various details setting. |
| ⑥ | Contrast control | |
| ⑦ | Brightness control | |
| ⑧ | CompactFlash (TM) eject button | |
| ⑨ | CompactFlash (TM) slot | |
| ⑩ | Cover detection switch | |
| ⑪ | Connector for external switch | |
| ⑫ | Connector for control-box connection | |



- Lightly press the target key on the touch panel with a fingertip to operate the IP-420. If you operate with any means other than your fingertip, the IP-420 can malfunction or the glass surface of the touch panel can be scratched or break.
- When READY key is pressed first after turning ON the power, origin retrieval of the clamp foot is performed. At this time, the clamp foot moves. So, be careful.

(2) Buttons used in common

Buttons that perform common operation in the respective screens of IP-410 are as described below.

| Pictograph | Name | Description |
|---|------------------------|--|
|  | CANCEL button | Pop-up screen is closed. In case of the data change screen, the data during changing can be cancelled. |
|  | ENTER button | Data changed are determined. |
|  | UP SCROLL button | This button scrolls button or display upward. |
|  | DOWN SCROLL button | This button scrolls button or display downward. |
|  | RESET button | This button releases error and the like. |
|  | NUMBER INPUT button | Ten keys are displayed and input of number can be performed. |
|  | CHARACTER INPUT button | Character input screen is displayed. |

(3) Basic operation

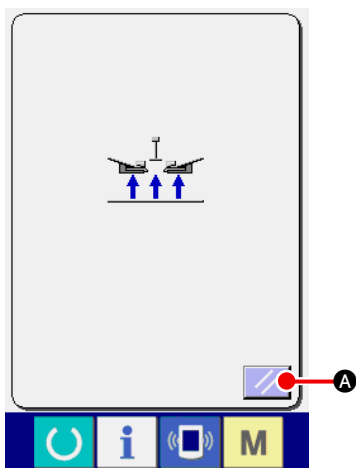

① Turn ON the power switch.

First, turn ON the power switch.

Reset pop-up screen is displayed after displaying WELCOME screen. Press RESET button  **A**.





When RESET button is pressed, the binder goes up. So, be careful.



Next, language selection pop-up screen is displayed. After selecting the language you desire to display, press ENTER button  **B**. Then the independent sewing input screen (screen A) of the figure below is displayed.



When ending the selection screen with CANCEL button  or ENTER button  without performing the language selection, the language selection screen is displayed whenever the power is turned ON.

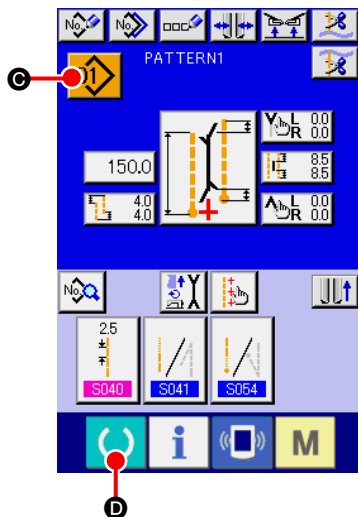

The independent sewing input screen (screen A)

② **Select pattern No. you desire to sew.**

When PATTERN NO. button  **C** is pressed, the pattern No. can be selected. For the selecting procedure of pattern No., see “[VI-7. \(1\) Performing the selection of pattern](#)”p.42.

At the time of your purchase, pattern Nos. 1 to 10 have been registered. Change the sewing data in accordance with the sewing types for use. (The number to which the pattern has not been registered is not displayed.)



For the detailed explanation of input screen, see “[VI-3. EX PLANATION OF THE BASIC SCREEN](#)” p.28.

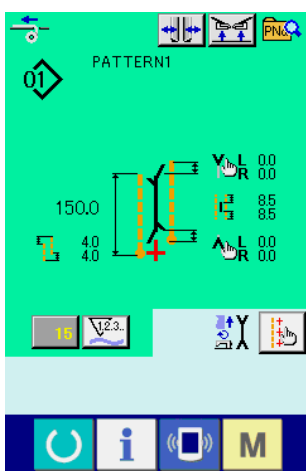

Sewing screen (screen B)

③ **Start sewing**

When READY key  **D** is pressed in the independent sewing input screen (screen A), the green sewing screen (screen B) is displayed and the sewing operation is started by the pedal operation.



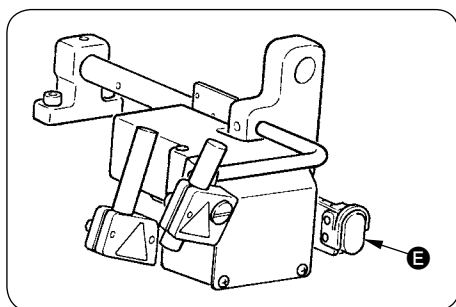

For the details of the sewing screen, see “[VI-3. EX PLANATION OF THE BASIC SCREEN](#)” p.28.

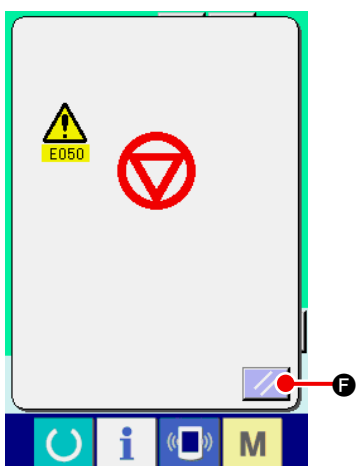

④ **To stop the device during operation**

When temporary stop switch **E** is pressed during sewing, the device can be stopped.



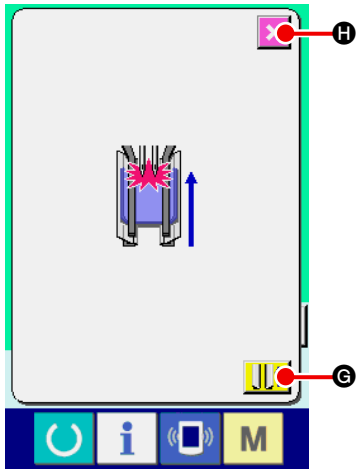

At this time, the error screen is displayed to inform that stop switch is pressed. When RESET button  **F** is pressed, the error is released and the screen returns to the input screen.



⑤ **Depress back the pedal at the time of mounting the breast box device.**



At the time of mounting SA122 the breast box device, when depressing back the pedal in the green sewing screen (screen B), the confirmation screen as shown on the left side is displayed. When the clamp foot moves to the back by depressing back the pedal, it retreats with the flap presser closed. This screen is to confirm whether material is put on the clamp foot. Confirming message saying that "Clamp foot moves to the back with flap presser closed. Remove material on the clamp foot" is displayed.

When there is no material on the clamp foot, press CLAMP FOOT BACK button  **G** and the clamp foot moves to the back with the flap presser closed. At the same time, the confirming screen is released and the screen returns to the sewing screen.

When canceling clamp foot back, press CANCEL button 

H, and the flap presser is opened. Then the clamp foot does not move to the back. At the same time, the confirming screen is released and the screen returns to the sewing screen.

When there is material on the clamp foot, be sure to press

 **CANCEL button**  **H** **and remove the material.**

Then depress back the pedal again to move the clamp foot to the back.

3. EXPLANATION OF THE BASIC SCREEN

(1) Input screen (Independent sewing mode)

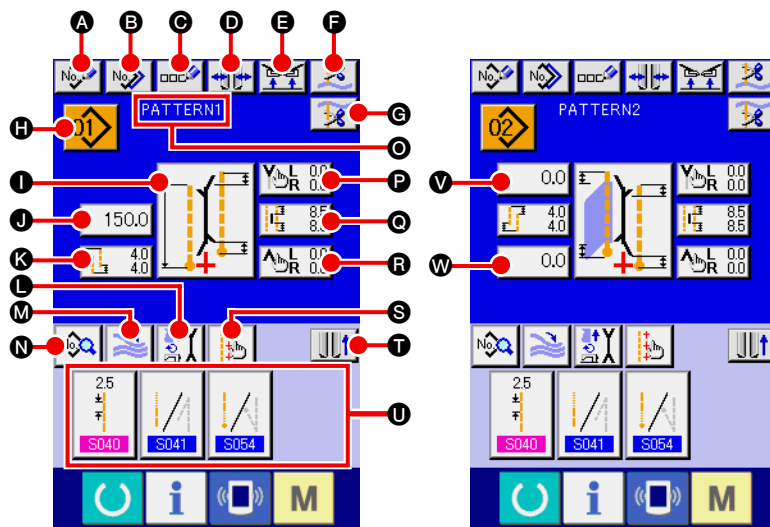

| Symbol | Name of button | Description |
|--------|---|---|
| A | NEW CREATION button | Independent sewing pattern new creation screen is displayed and new register of the pattern data can be performed. |
| B | COPY button | Independent sewing copy source pattern list screen is displayed and the pattern can be copied. |
| C | CHARACTER INPUT button | Character input screen is displayed and the name can be inputted to the pattern data. |
| D | TYPE OF WELT CHANGE-OVER button | Type of welt change-over screen is displayed, and change-over of type of welt and adjustment of parallelism of the binder can be performed. |
| E | CLAMP UP PROHIBITION AT SEWING END button | When this button is pressed, the clamp is returned in the lowered state at sewing end. It is convenient to use this button at the time of adjusting the marking light or trial sewing. |
| F | NEEDLE THREAD TRIMMING button | When this button is pressed, needle thread trimming knife comes down and the needle thread trimming operating screen is displayed. |
| G | BOBBIN THREAD TRIMMING button | Bobbin thread trimming knife opens while this button is pressed. |
| H | PATTERN NO. LIST button | Pattern No. list screen is displayed and the pattern data can be selected. |
| I | SEWING MODE SETTING button | Sewing mode S003 is selected. |
| J | L SIZE LENGTH SETTING button | In case of L size sewing, sewing length S004 is set. |
| K | DEFLECTION AMOUNT SETTING button | In case of slant sewing, deflection amount at the start of sewing S014 or deflection amount at the end of sewing S016 is set. |
| L | MOTION MODE SETTING button | With/without S001 of motion of sewing machine motor, center knife and corner knife. |
| M | STACKER MOTION/STOP CHANGE-OVER button | This button selects motion/stop S069 and S070 of stacker. |
| N | SEWING DATA DISPLAY button | Sewing pattern edit screen is displayed. Detailed sewing data that are not displayed in the input screen can be selected and edited. |
| O | PATTERN NAME display | Names that are inputted in pattern Nos. are displayed. |
| P | CORNER KNIFE MOTION POSITION AT SEWING START SETTING button | Cutting position S019 of corner knife at sewing start is set. |
| Q | CENTER KNIFE SETTING button | Center knife data edit screen is displayed, and center knife cutting position of sewing start S017 and sewing end S018 is set. |
| R | CORNER KNIFE MOTION POSITION AT SEWING END SETTING button | Cutting position S020 of corner knife at sewing end is set. |
| S | MARKING LIGHT SETTING button | Marking light setting screen is displayed, and changeover of marking light irradiation position S005 and setting of change of marking light set value S030 , S031 and S032 are performed. |
| T | CLAMP FOOT MOVE button | Clamp foot is moved to the front or to the back. |
| U | SEWING DATA SHORTCUT button | Shortcut buttons (max. 4 items) of the sewing data that are set in customizing in the sewing screen are displayed. |
| V | FLAP DROP DATA AT SEWING START SETTING button | Flap concealed stitching data at sewing start S008 or S010 is set. |
| W | FLAP DROP DATA AT SEWING END SETTING button | Flap concealed stitching data at sewing end S009 or S011 is set. |

* It is possible to customize display/non-display of the respective buttons.
For the details, refer to “VI-13. CUSTOMIZING THE DATA INPUT SCREEN” p.80.

(2) Sewing screen (Independent sewing mode)

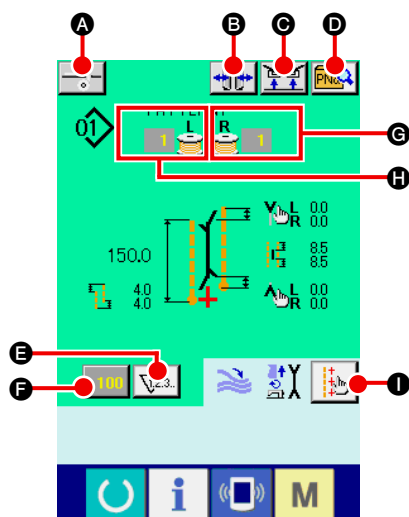

| Symbol | Name of button | Description |
|----------|--|---|
| A | INTERLINING SUPPLY button | When this button is pressed, interlining is supplied. * This is displayed when "With" of SA120 , automatic interlining supplying device is set with the optional setting. |
| B | TYPE OF WELT CHANGE-OVER button | Type of welt change-over screen is displayed and change-over of type of welt and adjustment of parallelism of the binder can be performed. |
| C | CLAMP UP PROHIBITION AT SEWING END button | When this button is held pressed, the clamp is returned in the lowered state at sewing end. It is convenient to use this button at the time of adjustment of marking light or trial sewing. |
| D | DIRECT PATTERN LIST button | Direct pattern list screen is displayed and selection of the sewing data can be performed. |
| E | COUNTER CHANGE-OVER button | When this button is pressed, the display of sewing counter and number of pcs. counter is changed over. * This button is displayed only when both sewing counter and number of pcs. counter are ON. |
| F | COUNTER VALUE CHANGE button | This button changes the counter value which is displayed at present. |
| G | BOBBIN THREAD (RIGHT) REMAINING AMOUNT VALUE | This button detects reflecting light from bobbin and informs that bobbin thread remaining amount is running out. When one stitching completes, the counter value is subtracted, and the count-up screen is displayed when "0" is reached. * This button is displayed only when the reflecting light from bobbin is detected. |
| H | BOBBIN THREAD (LEFT) REMAINING AMOUNT VALUE | This button detects reflecting light from bobbin and informs that bobbin thread remaining amount is running out. When one stitching completes, the counter value is subtracted and the count-up screen is displayed when "0" is reached. * This button is displayed only when the reflecting light from bobbin is detected. |
| I | MARKING LIGHT SETTING button | Marking light setting screen is displayed, and changeover of marking light irradiation position S005 and setting of change of marking light set value S030 , S031 and S032 are performed. |

- * It is possible to customize display/non-display of the respective buttons.
For the details, refer to **"VI-13. CUSTOMIZING THE DATA INPUT SCREEN" p.80.**

(3) Input screen (Alternate sewing mode)

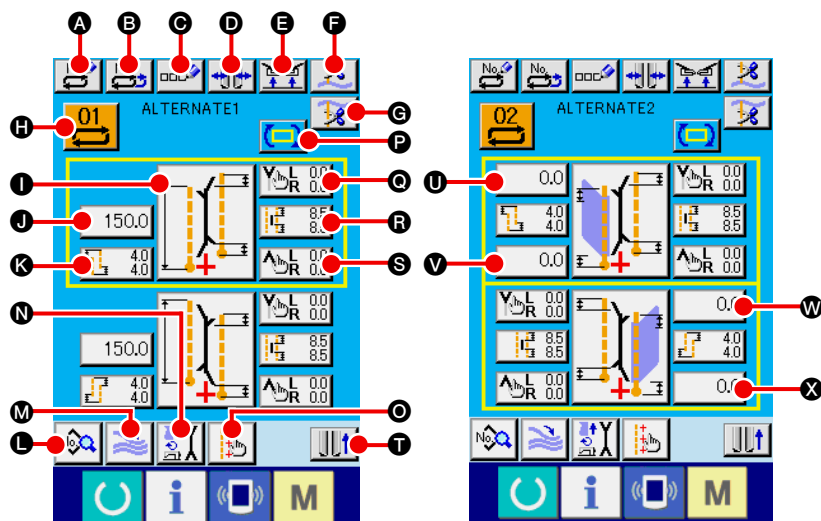

| Symbol | Name of button | Description |
|--------|--|---|
| A | NEW CREATION button | Alternate sewing data new creation screen is displayed and new register of data can be performed. |
| B | COPY button | Alternate sewing data copy source No. list is displayed and alternate sewing data can be copied. |
| C | CHARACTER INPUT button | Character input screen is displayed and name input can be performed in the alternate sewing data. |
| D | TYPE OF WELT CHANGE-OVER button | Type of welt change-over screen is displayed, and change-over of type of welt and adjustment of parallelism of the binder can be performed. |
| E | CLAMP UP PROHIBITION AT SEWING END button | When this button is held pressed, clamp is returned in the lowered state at the time of sewing end. It is convenient to use this button at the time of adjusting marking light or trial sewing. |
| F | NEEDLE THREAD TRIMMING button | When this button is pressed, needle thread trimming knife comes down and needle thread trimming in motion screen is displayed. |
| G | BOBBIN THREAD TRIMMING button | Bobbin thread trimming knife opens while this button is pressed. |
| H | PATTERN NO. LIST button | Pattern No. list screen is displayed and alternate sewing data can be selected. |
| I | SEWING MODE CHANGE-OVER button | Sewing mode S003 is selected. |
| J | L SIZE LENGTH SETTING button | In case of L size sewing, sewing length S004 is set. |
| K | DEFLECTION AMOUNT SETTING button | In case of slant sewing, deflection amount at the start of sewing S014 or deflection amount at the end of sewing S016 is set. |
| L | SEWING DATA DISPLAY button | Sewing pattern edit screen is displayed. This button selects detailed sewing data that are not displayed in the input screen and can edit the data. |
| M | STACKER MOTION/STOP CHANGE-OVER button | This button selects motion/stop S069 and S070 of stacker. |
| N | MOTION MODE SETTING button | With/without motion S001 of sewing machine motor, center knife and corner knife. |
| O | MARKING LIGHT SETTING button | Marking light setting screen is displayed, and changeover of marking light irradiation position S005 and setting of change of marking light set value S030 , S031 and S032 are performed. |
| P | NEXT SEWING DATA CHANGE-OVER button | Sewing pattern to be sewn next which is enclosed with yellow frame is changed over. * This is not displayed when flap priority sewing selection S002 is ON. |
| Q | CORNER KNIFE MOTION POSITION AT SEWING START SETTING button | Cutting position S019 of corner knife at sewing start is set. |
| R | CENTER KNIFE SETTING button | Center knife data edit screen is displayed and center knife cutting position of sewing start S017 and sewing end S018 . |
| S | CORNER KNIFE MOTION POSITION AT SEWING END SETTING button | Cutting position S020 of corner knife at sewing end is set. |
| T | CLAMP FOOT MOVE button | Clamp foot is moved to the front or to the back. |
| U, V | FLAP CONCEALED STITCHING DATA AT SEWING START SETTING button | Flap concealed stitching data at sewing start S008 or S010 is set. |
| W, X | FLAP CONCEALED STITCHING DATA AT SEWING END SETTING button | Flap concealed stitching data at sewing end S009 or S011 is set. |

* It is possible to customize display/non-display of the respective buttons.
For the details, refer to “VI-13. CUSTOMIZING THE DATA INPUT SCREEN” p.80.

(4) Sewing screen (Alternate sewing mode)

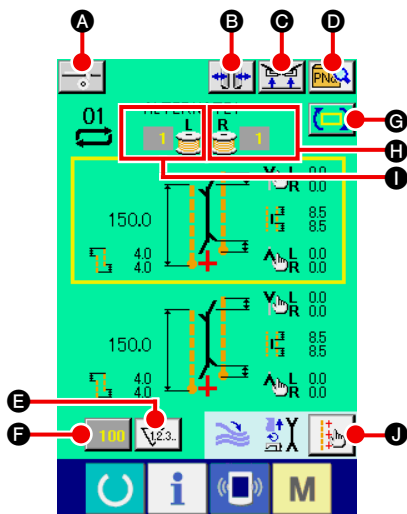

| Symbol | Name of button | Description |
|--------|--|---|
| Ⓐ | INTERLINING SUPPLYING button | When this button is pressed, interlining is supplied. * This is displayed when "With" of S0120 , automatic interlining supplying device is set with the optional setting. |
| Ⓑ | TYPE OF WELT CHANGE-OVER button | Type of welt change-over screen is displayed, and change-over of type of welt and adjustment of parallelism of the binder can be performed. |
| Ⓒ | CLAMP UP PROHIBITION AT SEWING END button | When this button is held pressed, the clamp is returned in the lowered state at the time of sewing end. It is convenient to use this button at the time of adjustment of marking light and trial sewing. |
| Ⓓ | DIRECT PATTERN LIST button | Direct pattern list screen is displayed and selection of the sewing data can be performed. |
| Ⓔ | COUNTER CHANGE-OVER button | When this button is pressed, display of sewing counter and number of pcs. counter is changed over. This button is displayed only when both sewing counter and number of pcs. counter are ON. |
| Ⓕ | COUNTER VALUE CHANGE button | Counter value which is displayed at present is changed. |
| Ⓖ | NEXT SEWING DATA CHANGE-OVER button | Sewing pattern to be sewn next which is enclosed with yellow frame is changed over. * This is not displayed when flap priority sewing selection S002 is ON. |
| Ⓗ | BOBBIN THREAD (RIGHT) REMAINING AMOUNT VALUE | This button detects reflecting light from bobbin and informs that bobbin thread remaining amount is running out. When one stitching completes, the counter value is subtracted, and the count-up screen is displayed when "0" is reached. * This button is displayed only when the reflecting light from bobbin is detected. |
| Ⓘ | BOBBIN THREAD (LEFT) REMAINING AMOUNT VALUE | This button detects reflecting light from bobbin and informs that bobbin thread remaining amount is running out. When one stitching completes, the counter value is subtracted, and the count-up screen is displayed when "0" is reached. * This button is displayed only when the reflecting light from bobbin is detected. |
| Ⓙ | MARKING LIGHT SETTING button | Marking light setting screen is displayed, and changeover of marking light irradiation position S005 and setting of change of marking light set value S030 , S031 and S032 are performed. |

* It is possible to customize display/non-display of the respective buttons.
For the details, refer to **"VI-13. CUSTOMIZING THE DATA INPUT SCREEN" p.80.**

(5) Input screen (Cycle sewing mode)

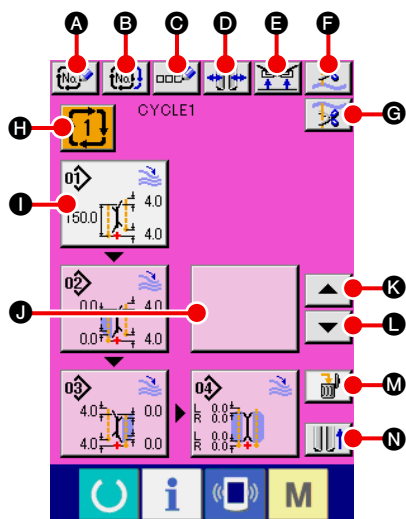

| Symbol | Name of button | Description |
|--------|---|---|
| A | NEW CREATION button | Cycle sewing data No. new creation screen is displayed and new register of cycle sewing data can be performed. |
| B | COPY button | Cycle sewing data copy source No. list screen is displayed and cycle sewing data can be copied. |
| C | CHARACTER INPUT button | Character input screen is displayed and name can be inputted to the cycle sewing data. |
| D | TYPE OF WELT CHANGE-OVER button | Type of welt change-over screen is displayed and change-over of type of welt, and adjustment of parallelism of the binder can be performed. |
| E | CLAMP UP PROHIBITION AT SEWING END button | When this button is held pressed, the clamp is returned in the lowered state at the time of sewing end. It is convenient to use at the time of adjustment of marking light and trial sewing. |
| F | NEEDLE THREAD TRIMMING button | Needle thread trimming knife comes down and the needle thread trimming in motion screen is displayed. |
| G | BOBBIN THREAD TRIMMING button | While this button is held pressed, bobbin thread trimming knife opens. |
| H | CYCLE SEWING DATA NO. LIST button | Cycle sewing data No. list screen is displayed and the cycle sewing data can be selected. |
| I | PATTERN DATA EDIT button | Edit of pattern data which have been registered to cycle sewing data can be performed. * For the editing procedure, refer to “3-(1) Input screen (Independent sewing mode)” p.28. |
| J | PATTERN DATA EDIT button (blank) | When this blank button is pressed, the pattern list screen to register the pattern data to the cycle sewing data is displayed, and it is possible to select and register the pattern data. |
| K | CYCLE RETURN button | Pattern data to be sewn next which is displayed with white emphasis is moved forward by one. In case of first pattern, it moves to the last pattern. |
| L | CYCLE FEED button | Pattern data to be sewn next which is displayed with white emphasis is moved backward by one. In case of the last pattern, it moves to the first pattern. |
| M | PATTERN DATA DELETION button | Pattern data which is displayed with white emphasis is deleted from register. |
| N | CLAMP FOOT MOVE button | Clamp foot is moved to the front or to the back. |

* It is possible to customize display/non-display of the respective buttons.
For the details, refer to **“VI-13. CUSTOMIZING THE DATA INPUT SCREEN” p.80.**

(6) Sewing screen (Cycle sewing mode)

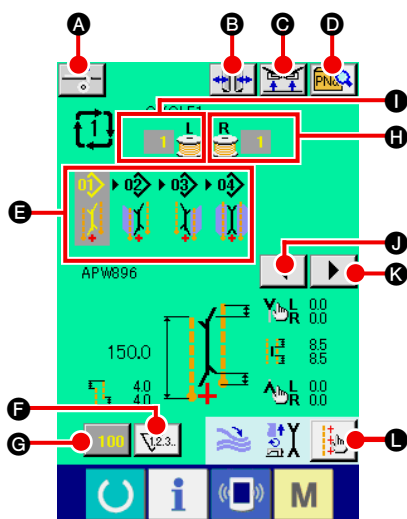

| Symbol | Name of button | Description |
|--------|---|---|
| A | INTERLINING SUPPLYING button | When this button is pressed, interlining is supplied. * This is displayed when "With" of SA120 , automatic interlining supplying device is set with optional setting. |
| B | TYPE OF WELT CHANGE-OVER button | Type of welt change-over screen is displayed, and change-over of type of welt and adjustment of parallelism of the binder can be performed. |
| C | CLAMP UP PROHIBITION AT SEWING END button | When this button is held pressed, the clamp is returned in the lowered state at the time of sewing end. It is convenient to use this button at the time of adjustment of marking light and trial sewing. |
| D | DIRECT PATTERN LIST button | Direct pattern list screen is displayed and selection of the sewing data can be performed. |
| E | CYCLE DATA display | All pattern data that have been registered to the cycle sewing data are displayed. |
| F | COUNTER CHANGE-OVER button | When this button is pressed, display of sewing counter and number of pcs. counter is changed over. This button is displayed only when both sewing counter and number of pcs. counter are ON. |
| G | COUNTER VALUE CHANGE button | Counter value which is displayed at present is changed. |
| H | BOBBIN THREAD (RIGHT) REMAINING AMOUNT | This button detects light from bobbin and informs that bobbin thread remaining amount is running out. When one stitching completes, the counter value is subtracted, and the counter-up screen is displayed when "0" is reached. * This button is displayed only when the reflecting light from bobbin is detected. |
| I | BOBBIN THREAD (LEFT) REMAINING AMOUNT | This button detects reflecting light from bobbin and informs that bobbin thread remaining amount is running out. When one stitching completes, the counter value is subtracted, and the counter-up screen is displayed when "0" is reached. * This button is displayed only when the reflecting light from bobbin is detected. |
| J | LEFT SCROLL button | Pattern data to be sewn next is moved forward by one. In case of the first pattern, it moves to the last pattern. |
| K | RIGHT SCROLL button | Pattern data to be sewn next is moved backward by one. In case of the last pattern, it moves to the first pattern. |
| L | MARKING LIGHT SETTING button | Marking light setting screen is displayed, and changeover of marking light irradiation position S005 and setting of change of marking light set value S030 , S031 and S032 are performed. |

* It is possible to customize display/non-display of the respective buttons.
For the details, refer to "VI-13. CUSTOMIZING THE DATA INPUT SCREEN" p.80.

4. USING THE COUNTER

(1) Setting procedure of the counter

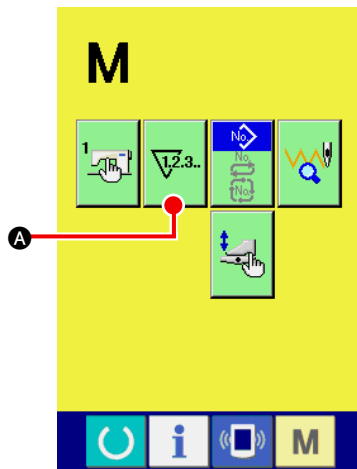

① **Display the counter setting screen.**

Press MODE CHANGEOVER key **M** from the input screen and

COUNTER SETTING button **V2.3.** **A** is displayed on the screen.

Press this button and “COUNTER SETTING screen (screen A)” is displayed.

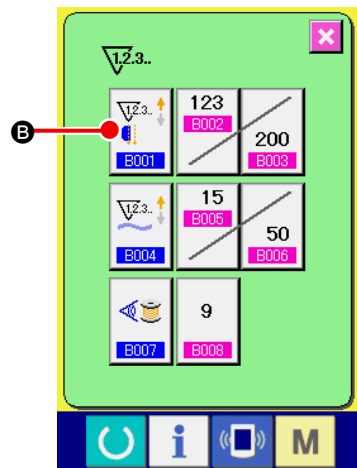

② **Select the kind of counter.**

There are three kinds of counters with this sewing machine, sewing counter, number of pcs. counter and bobbin thread remaining amount adjustment counter.

Press sewing counter button **B001** **B** in “counter setting screen

(screen A)”, and “sewing counter setting screen (screen B)” is displayed. Then the kind of counter can be set.

Counter setting screen
(Screen A)

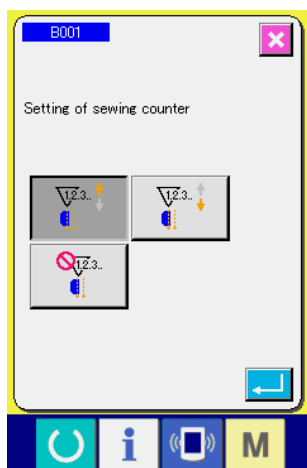

Sewing counter setting
screen (Screen B)

| [Sewing counter] | |
|--------------------|---|
| | <p>UP counter</p> <p>Every time one sewing is performed, the existing value is counter up. When the existing value is equal to the set value, the count-up screen is displayed.</p> |
| | <p>DOWN counter</p> <p>Every time one sewing is performed, the existing value is counted down. When the existing value is reached to “0”, the count-up screen is displayed.</p> |
| | <p>Counter unused</p> <p>Sewing counter is set to the prohibition.</p> |

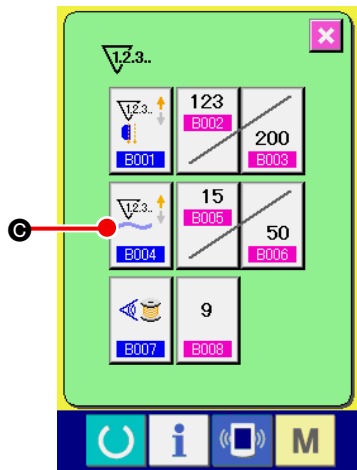

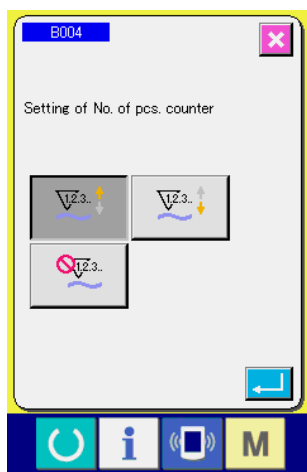

**Counter setting screen
(Screen A)**

Press NUMBER OF PCS. COUNTER button  **C** In “Counter setting screen (screen A)”, and “number of pcs. setting screen (screen C)” is displayed. Then the kind of counter can be set.



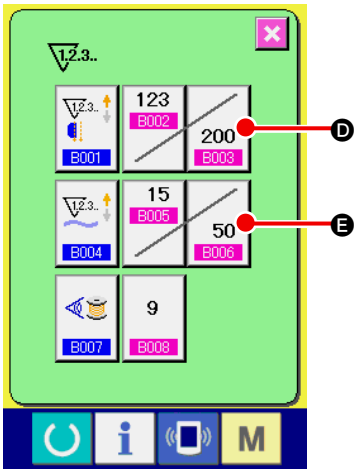

**Number of pcs. counter
(Screen C)**

| [Number of pcs. counter] | |
|---|---|
|  | <p>UP counter Every time one of finished products is sewn, the existing value is counted up.</p> <ul style="list-style-type: none"> * In case of independent sewing : 1 time of sewing <li style="padding-left: 20px;">In case of alternate sewing : 2 times of sewing <li style="padding-left: 20px;">In case of cycle sewing : 1 time of cycle sewing <p>The number given in each case above is regarded as one of finished products. When the existing value is equal to the set value, the count-up screen is displayed.</p> |
|  | <p>DOWN counter Every time one of finished products is sewn, the existing value is counted down. When the existing value is reached to “0”, the count-up screen is displayed.</p> |
|  | <p>Counter unused Number of pcs. counter is set to the prohibition.</p> |



③ Changing the target value of the counter

In case of the sewing counter, press button  **D**, and in case of the number of pcs. counter, press button  **E**, and “Numerical setting pop-up screen (screen D)” is displayed. Then the target value of counter can be set.

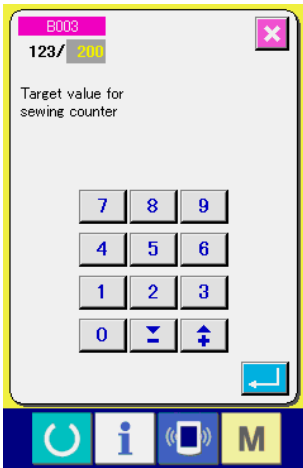

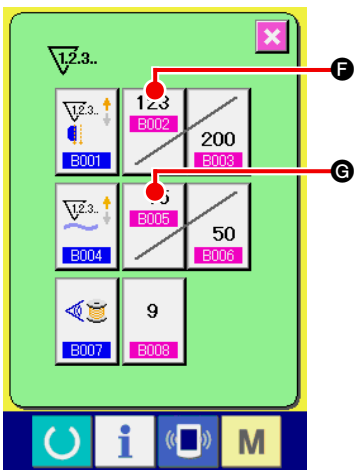

Numerical setting pop-up screen (screen D)

Here, input the target value of counter. When “0” is inputted to the target value of counter, only the existing value is displayed during sewing and the count-up screen is not displayed.



④ Change the existing value of counter

In case of the sewing counter, press button  **F** and in case of the number of pcs. counter, press  **G**, and “Numerical setting pop-up screen (screen E)” is displayed. Then the existing value of counter can be set.

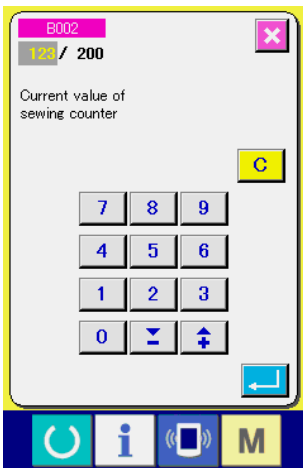

Numerical setting pop-up screen (screen E)

Here, input the existing value of counter.

(2) Releasing procedure of count-up

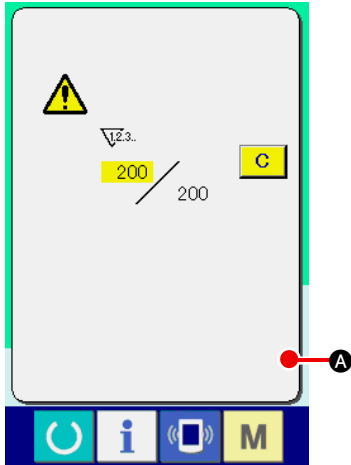

During the sewing work, the count-up condition is reached the count-up screen is displayed and the buzzer sounds. Press CLEAR button **C** **A** to reset the counter, and the screen returns to the sewing screen. And, counting starts again.

(3) Counter value changing procedure during sewing

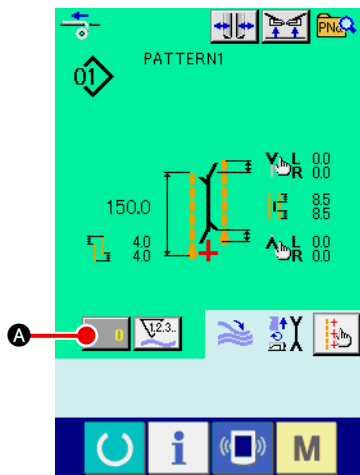

① Display the counter value change screen

When you desire to change the counter value during the sewing work, press COUNTER VALUE CHANGE button **0** **A** on the sewing screen. Counter value change screen is displayed.

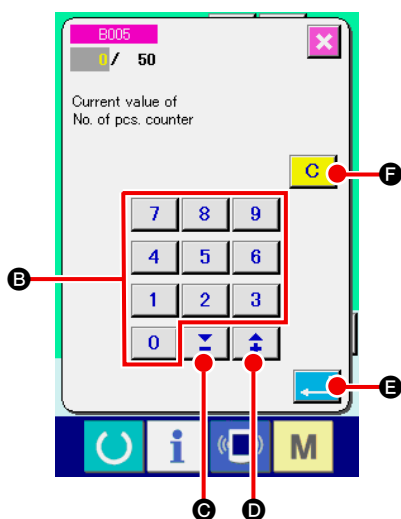

② Change the counter value

Change the counter value with TEN keys **0** to **9** **B** or ▼▲ button **-** **G** (**+** **D**).

③ Determine the counter value

Press ENTER button **↵** **E** and the data is determined. When you desire to clear the counter value, press CLEAR button **C** **F**.

5. USING THE BOBBIN THREAD AMOUNT ADJUSTMENT COUNTER

(1) Setting procedure of the bobbin thread remaining amount adjustment counter

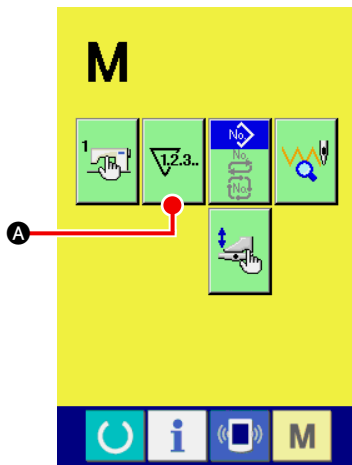

① Display the counter setting screen

Press MODE CHANGEOVER key **M** from the input screen,

COUNTER SETTING button  **A** is displayed on the screen..

Press this button and “Counter setting screen (screen A)” is displayed.

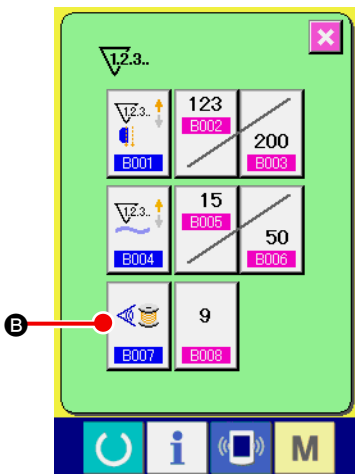

Counter setting screen
(Screen A)

② Set the bobbin thread remaining amount adjustment counter to ON.

Press BOBBIN THREAD REMAINING AMOUNT

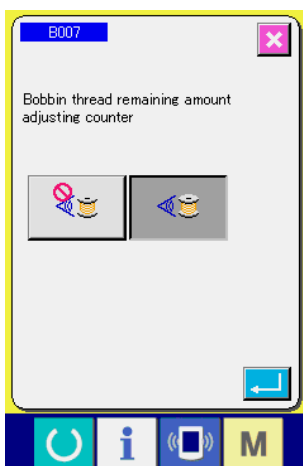

ADJUSTMENTCOUNTER MOTION SETTING button  **B**,

and “Bobbin thread remaining amount adjustment counter setting pop-up screen (screen B)” is displayed. Then the bobbin thread remaining amount adjustment counter motion (ON/OFF) can be set.



Bobbin thread remaining amount
adjustment value setting screen
(Screen B)

[Bobbin thread remaining amount detection]

| | |
|---|---|
|  | <p>Bobbin thread remaining amount adjustment counter ON :</p> <p>The counter detects the reflecting light from bobbin and informs that bobbin thread remaining amount is running out. Every time one sewing is performed, the counter value is subtracted and the count-up screen is displayed when the existing value is reached to “0”.</p> |
|  | <p>Bobbin thread remaining amount adjustment counter OFF :</p> <p>Bobbin thread remaining amount detection is set to the prohibition.</p> |

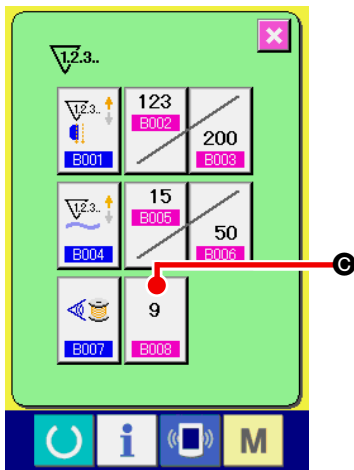

Counter setting screen
(Screen A)

- ③ **Set the bobbin thread remaining amount adjustment value**
Press BOBBIN THREAD REMAINING AMOUNT ADJUSTMENT VALUE SETTING button  and the bobbin thread remaining amount adjustment value setting screen (screen B) is displayed.

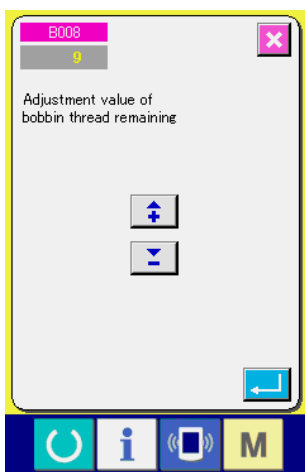

Bobbin thread remaining amount adjustment value setting screen
(Screen B)

Here, input the bobbin thread remaining amount adjustment value (0 to 9).

Set the number of times of sewing from detecting run-out of bobbin thread by the sensor to performing the count-up display.

When you desire to lengthen the remaining length bobbin thread :

→ Decrease the number (toward “0”).

When you desire to shorten the remaining length of bobbin thread :

→ Increase the number (toward 9).



*** Setting of the bobbin thread remaining amount adjustment counter ***

- 1) Set the bobbin thread remaining amount adjustment counter to the value shown in the table below.
- 2) Start the sewing to perform regular sewing. In case of test sewing, adjust the sewing length to that to be sewn in the actual process.
- 3) As you continue sewing, the bobbin thread is gradually reduced and the run-out of bobbin thread is displayed in the screen when the bobbin sensor detects the reflecting light.
- 4) At this time, check the length of bobbin thread remaining on the bobbin and properly modify the value on the counter.
- 5) Increasing the counter value by 1 will shorten the remaining length of bobbin thread by the amount that is consumed for one time of sewing.
- 6) The remaining length of bobbin thread at the time when the indication of run-out of bobbin thread varies by a certain extent. This variation depends on the type of thread, sewing length and the winding way of thread.

The remaining length of bobbin thread is shown, as a guide, in the table below. Correct the counter value in accordance with sewing conditions and the like so that the bobbin thread does not completely run out during sewing.

[The table shows the counter value when the sewing length is set to 150 mm]

| Thread count | Counter value | Bobbin thread remaining length for reference (m) |
|--------------|---------------|--|
| #40 | 1 | 0.4 to 2.6 |
| #50 | 2 | 0.2 to 2.6 |
| #60 | 2 | 0.4 to 2.8 |
| #80 | 3 | 0.1 to 3.0 |



- The bobbin thread remaining length has to be re-adjusted in the case described below.
 1. When the sewing length for the sewing product has been changed.
 2. When the thread count of bobbin thread has been changed.
- The value of bobbin thread remaining amount counter is cleared by inputting the value of the bobbin thread remaining amount adjustment counter.

- 7) If the bobbin has run out of thread, the bobbin thread remaining amount detecting device is incapable of performing “bobbin thread remaining amount detection”. So, it is very important to specify a value on the bobbin thread remaining amount adjustment counter to allow the device to give the indication of “run-out of bobbin thread” when the sufficient amount of bobbin thread remains.

(2) Releasing procedure of the bobbin thread remaining amount detection count-up

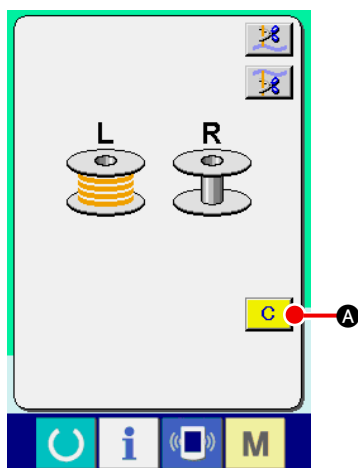

When the bobbin thread remaining amount counter value becomes “0” at the sewing end, the count-up screen is displayed and the buzzer sounds. Replace the bobbin thread of the bobbin where the bobbin thread remains few.

When CLEAR button **C** **A** is pressed, the bobbin thread remaining amount counter value is reset and the screen returns to the sewing screen.

6. CHANGING THE SEWING MODE

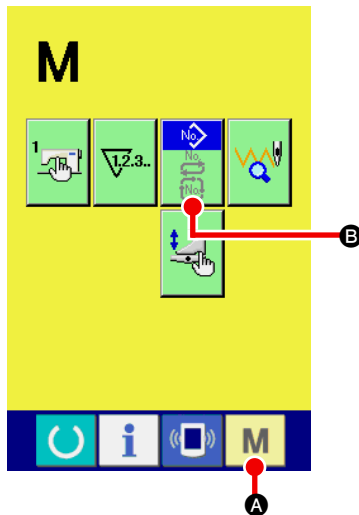

① Display the sewing mode selection screen

Press SEWING MODE CHANGEOVER key **M** **A** and the mode change-over screen is displayed.

② Select the sewing mode

Press MODE SELECTION button **B** and the indication of button is changed.

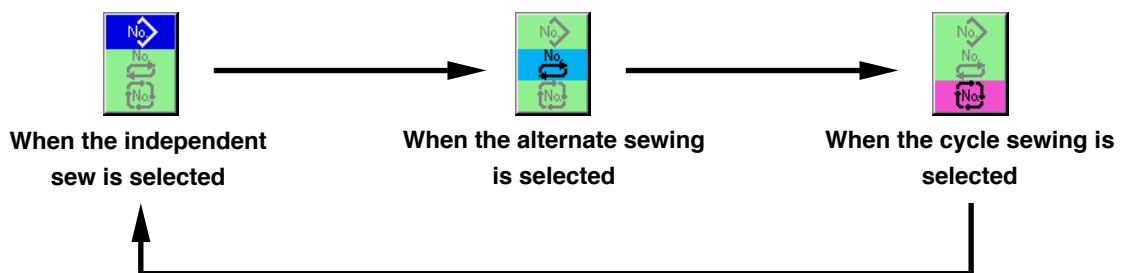

③ Determine the sewing mode.

Press MODE CHANGEOVER key **M** **A** and the data input screen of the selected sewing mode is displayed.

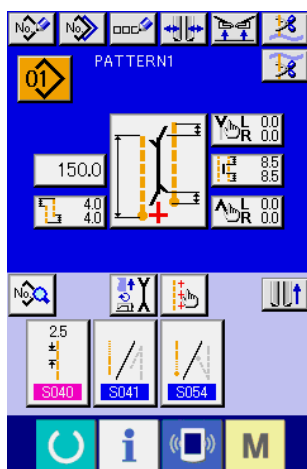

Independent sewing input screen

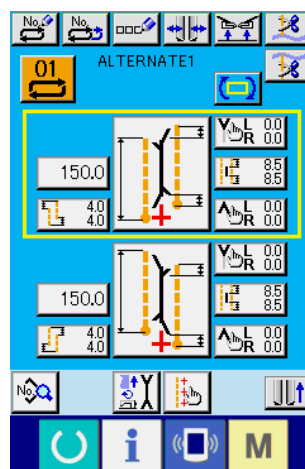

Alternate sewing input screen

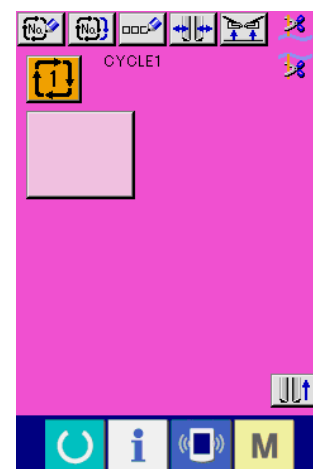

Cycle sewing input screen

7. USING THE SEWING PATTERN

(1) Performing the selection of pattern

① Display the input screen

When the input screen of independent sewing mode, alternate sewing mode and cycle sewing mode is displayed, the selection of pattern can be selected.

By customizing the sewing screen, the selection of pattern can be performed from the sewing screen as well.

② Call the pattern list screen

Press PATTERN LIST button ,  or  (A) and the pattern list screen is displayed.

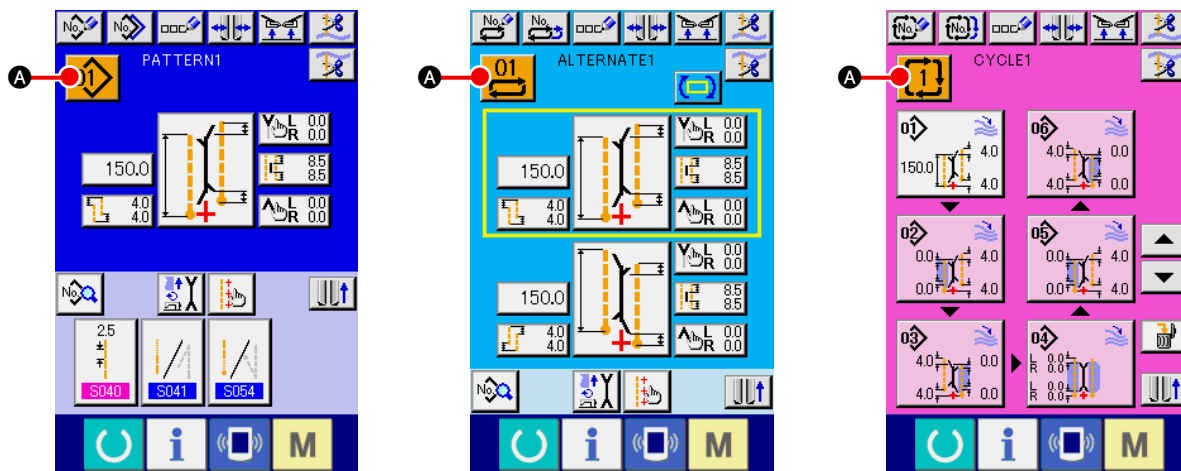

③ Select the pattern

Press pattern data you desire to select (B).

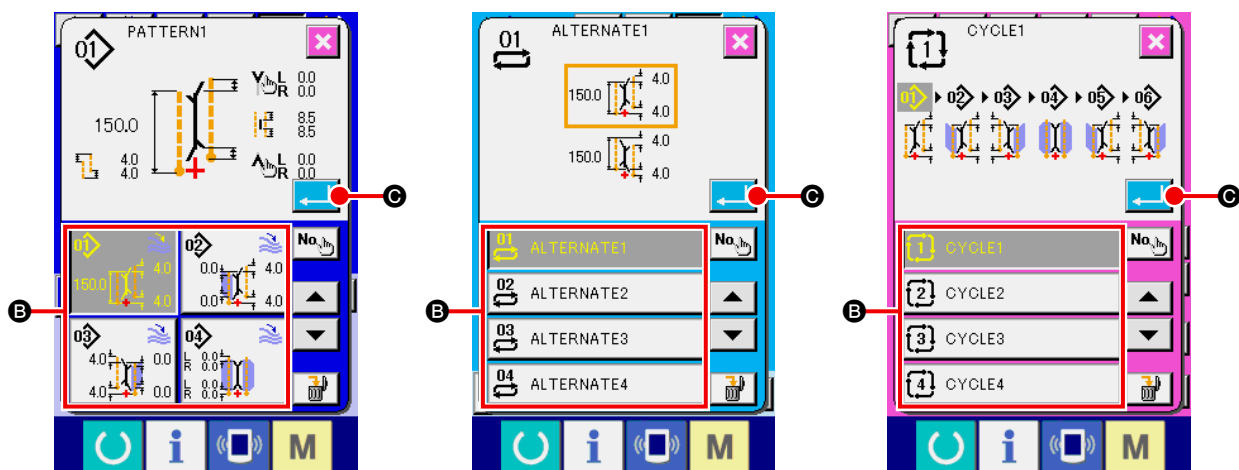

④ Determine the pattern



When ENTER button  (C) is pressed, the pattern is selected and the screen returns to the input screen.

(2) Performing the new creation of pattern

① Display the input screen



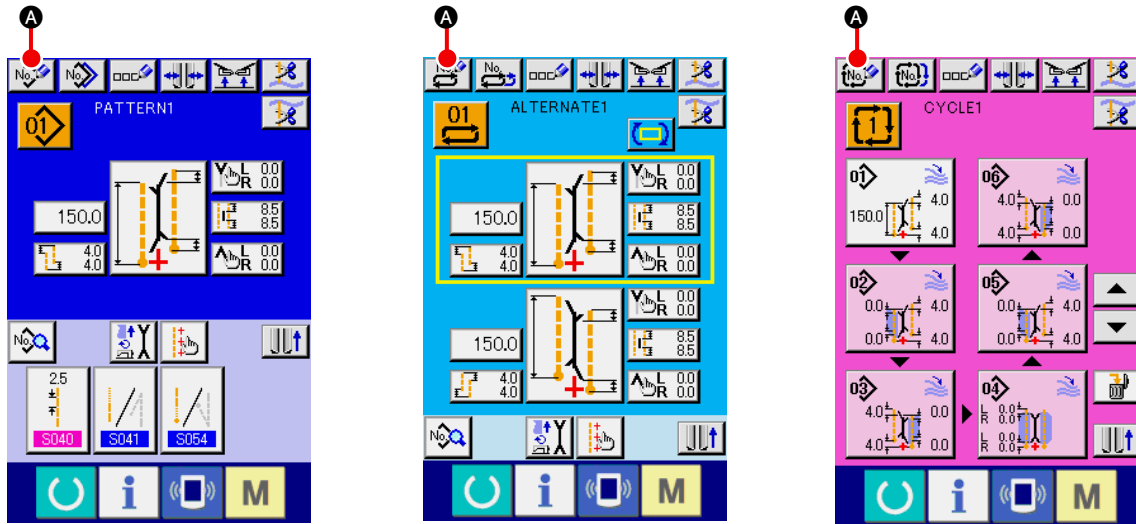

When the input screen of independent sewing mode, alternate sewing mode and cycle sewing mode is displayed, the new creation of pattern can be performed.

② Call the sewing pattern new creation screen

Press NEW CREATION button ,  or  **A**, and the pattern new creation screen is displayed.



③ Input the pattern No.

Input pattern No. you desire to newly create with ten keys  to  **B**. It is possible to retrieve pattern No. which has not been registered yet with  **C** and  **D**.

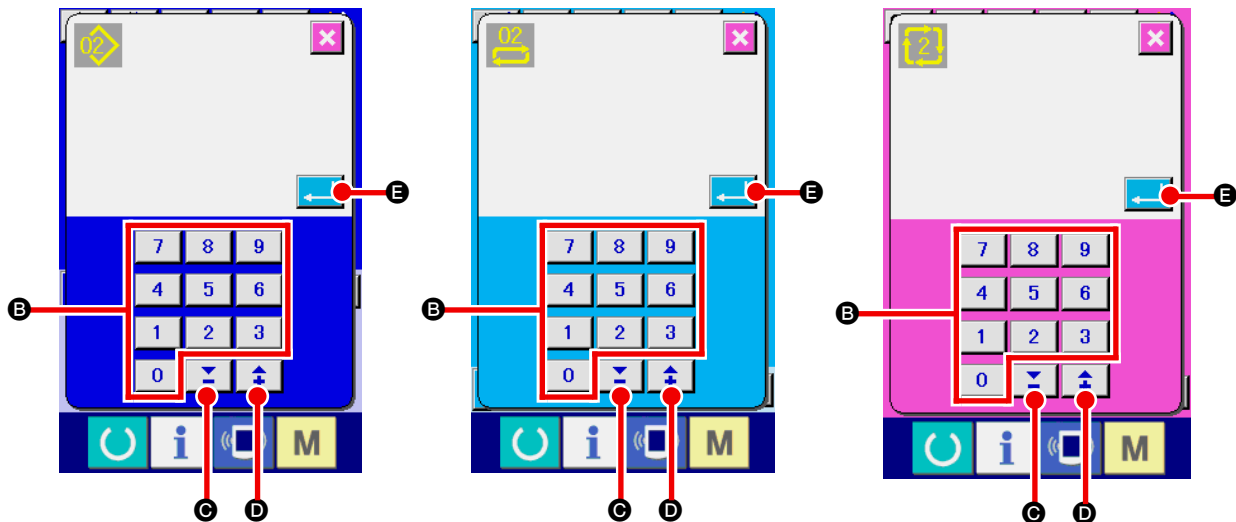

④ Determine the pattern No.

When ENTER button  **E** is pressed, the pattern No. to newly create is determined and the screen returns to the input screen.

(3) Copying the pattern

The pattern which has been already registered can be copied to the sewing pattern which has not registered yet. Copying of overwriting of pattern is prohibited. So, when you desire to overwrite, perform it after erasing the pattern once.

→ For the erasing procedure, see “VI-7. (4) Erasing the pattern” p.46.





When performing copying the pattern No. which has been already registered, copy disapproved error (E401) is displayed.

① Display the input screen

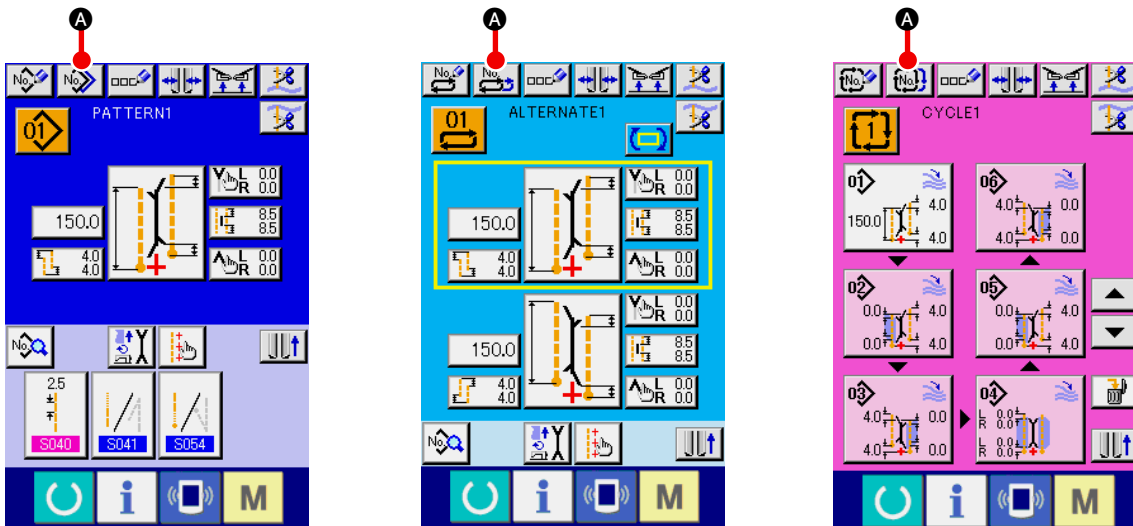
When the input screen of independent sewing mode, alternate sewing mode and the cycle sewing mode is displayed, it is possible to copy.



② Call the pattern No. list screen of the copy source

Press PATTERN COPY button  ,  or  (A), and the copy source pattern list screen is displayed.

③ **Select the pattern of copy source**

Select the pattern of copy source from PATTERN LIST button **B**.

Next, press COPY DESTINATION NO. INPUT button **No.** **C** and the copy destination input screen (screen B) is displayed.

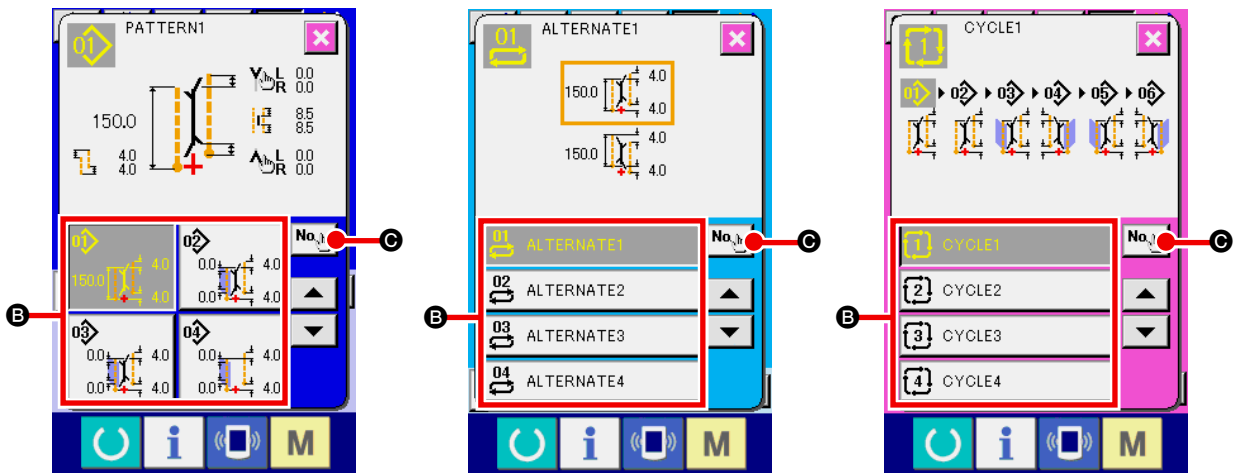

Copy destination No. input screen (screen B)

④ **Input the pattern No. of copy destination**

Input the pattern No. of copy destination with ten keys **0** to **9** **B**. It is possible to retrieve the pattern No. which has not been used yet with **▼▲** buttons (**▼** **C** and **▲** **D**).

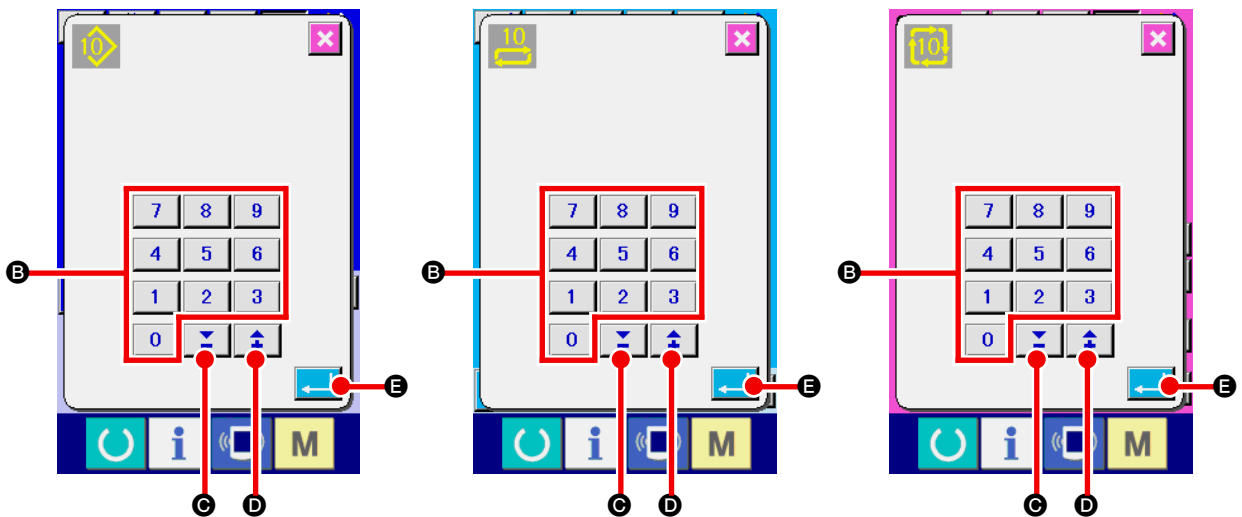

Copy destination No. input screen (screen B)

⑤ **Start copying**

When ENTER button **↵** **E** is pressed, copying starts. The pattern No. which has been copied is in the selection state and returns to the copy source pattern list screen (screen A).

(4) Erasing the pattern

① Display the input screen

When the input screen of independent sewing mode, alternate sewing mode and cycle sewing mode is displayed, it is possible to erase the pattern.

② Call the pattern list screen

Press PATTERN LIST button ,  or  **A** and the pattern No. list screen (screen A) is displayed.

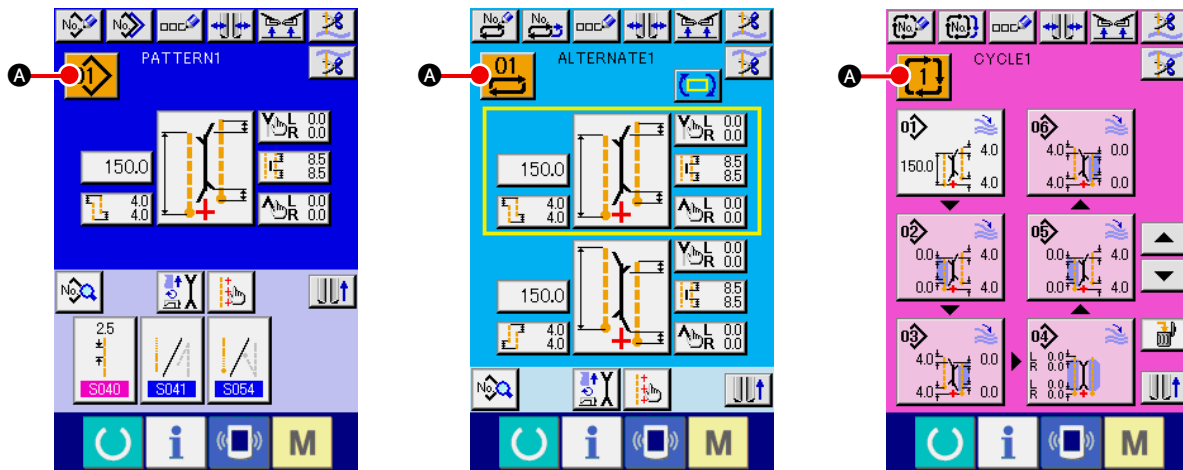

③ Select the pattern to be erased

Select the pattern to be erased from pattern list button **B**.

Next, press ERASE button  **C** and the pattern erase confirmation screen is displayed.

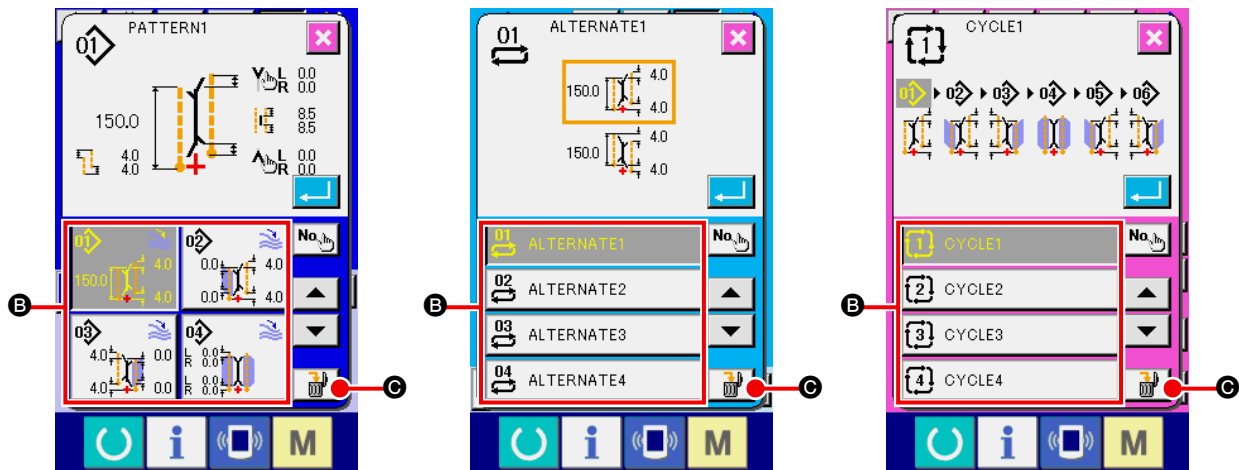

Pattern No. list screen (screen A)

④ Determine the pattern to be erased

Press ENTER button  in the pattern erase confirmation screen and the pattern is erased.

When CANCEL button  is pressed, the screen returns to the original screen A without erasing the pattern.

(5) Naming the pattern

① Display the input screen

When the input screen of independent sewing mode, alternate sewing mode and cycle sewing mode is displayed, it is possible to input the name to the pattern data.

② Call the character input screen

Press CHARACTER INPUT button  **A** and the character input screen (screen B) is displayed.

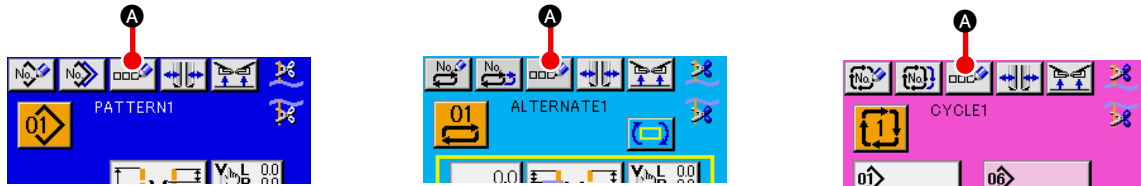

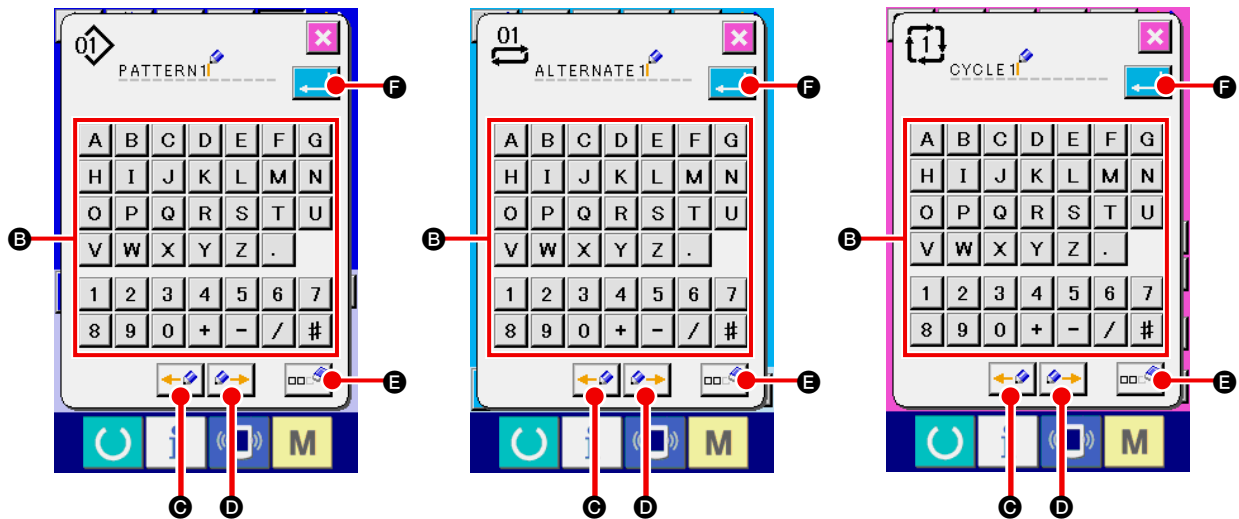

Data input screen (screen A)



Character input screen (screen B)

③ Input the character

It is possible to input the character by pressing CHARACTER button **B** you desire to input. As many as 14 characters of characters (**A** to **Z** and **0** to **9**) and symbols (**+** , **-** , **/** , **#** , **.** and **,**) can be inputted. Cursor can be moved with CURSOR LEFT MOVE button  **C** and CURSOR RIGHT MOVE button  **D**. When you desire to erase the inputted character adjust the cursor to the position of the character you desire to erase and press ERASE button  **E**.

④ End the character input

Press ENTER button  **F** to end the character input. After the end, the inputted character is displayed at the upper part of the input screen.

(6) Editing procedure of the cycle sewing data

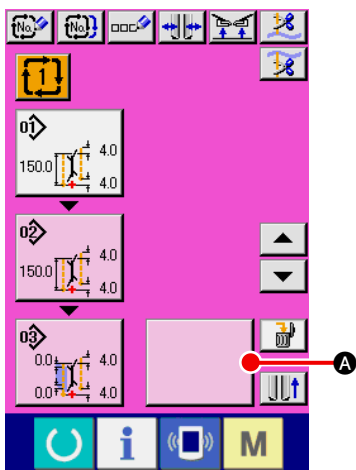

Cycle sewing input screen
(Screen C)

① Display the cycle sewing input screen

When the input screen of cycle sewing ode is displayed, it is possible to edit the cycle sewing data.

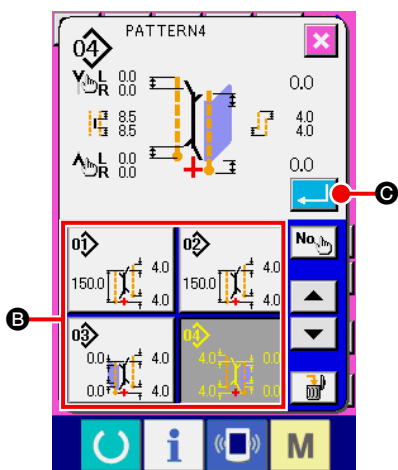

Pattern list screen
(Screen B)

② Register the pattern data

Press BLANK button  **A** and the pattern list screen (screen B) is displayed.

Select the pattern data you desire to register from PATTERN LIST button **B** and press ENTER button  **C**. Then the selected pattern data is registered to the blank section.

When the first pattern data is registered, BLANK button 

D is displayed in the second place. Repeat the operation of ② in case of need.





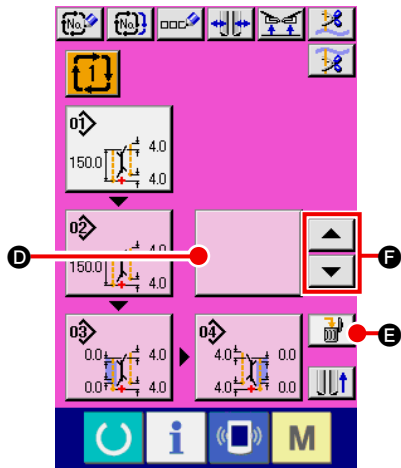

As many as 6 pattern data can be registered to the cycle sewing data.



Cycle sewing input screen
(Screen C)

③ Erase the registered pattern data

Press ERASE button  **E** and the pattern data which is displayed with white emphasis is erased. Select the pattern data you desire to erase with UP/DOWN SCROLL buttons  and  **F** and erase it.

 The pattern data which is displayed with white emphasis is the pattern data to be sewn next. So, move it in accordance with the sewing work.

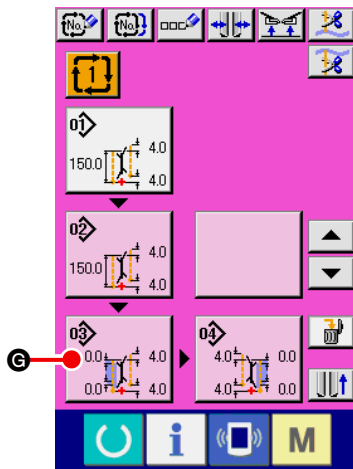

④ Edit the registered pattern data

Press PATTERN DATA button  **G** you desire to edit and the pattern data edit screen (screen D) is displayed in pop-up.

Refer to “[VI-3-\(1\) Input screen \(Independent sewing mode\)](#)” p.28.

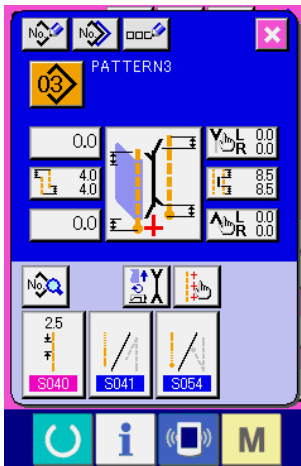

Pattern data edit screen
(Screen D)

8. CHANGING THE SEWING DATA

(1) Changing procedure of the sewing data

① Display the input screen

When the input screen of independent sewing mode, alternate sewing mode and cycle sewing mode is displayed it is possible to change the swing data.

The sewing data which are frequently used can be registered to SEWING DATA SHORTCUT button **B** in the input screen and be set directly. In addition, the detailed sewing data can be set by pressing  **A**.

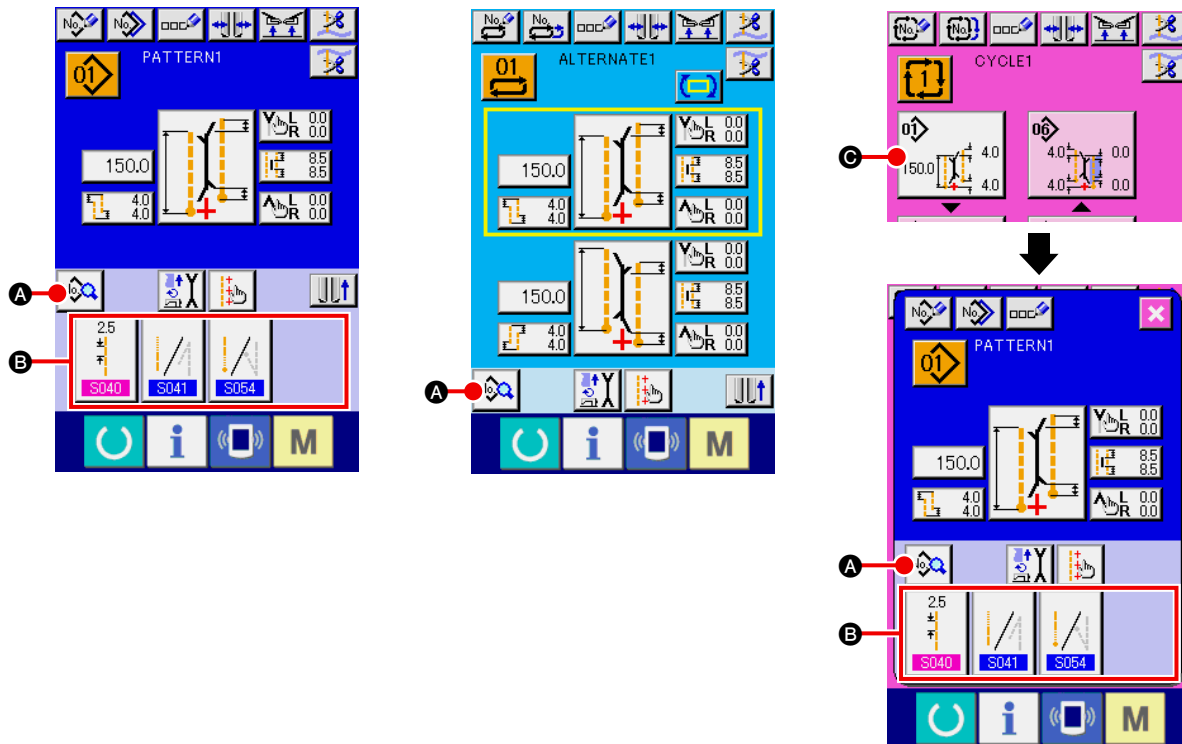

1. When changing the sewing data of cycle sewing mode, press PATTERN DATA EDIT button  and it is possible to change.
2. In case of alternate sewing mode, SEWING DATA SHORTCUT button **B** is not displayed.
3. For SEWING DATA SHORTCUT button **B**, refer to “[VI-13. CUSTOMIZING THE DATA INPUT SCREEN](#)” p.80.
4. For the details of sewing data, refer to “[① Items displayed in the data input screen of VI-8-\(2\) Sewing data list](#)” p.51.

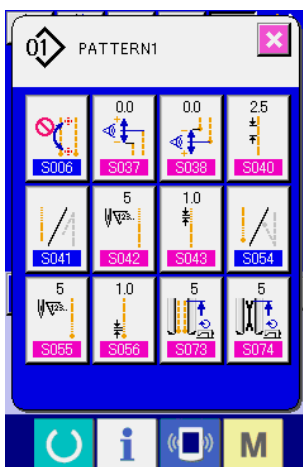

Sewing data list screen (Screen A)

② Select the sewing data to be changed



















Press  **A** and the sewing data list screen (screen A) is displayed. Then select the data you desire to change.











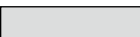



Data items which are not used due to the shape are not displayed. So, be careful.

(2) Sewing data list





① Items that are displayed in the data input screen



| No. | Item | Setting range / Edit unit | Initial value |
|-------------|--|---------------------------|---|
| S001 | <p>Motion mode change-over With/without of motion of sewing machine motor, center knife and corner knife is selected.</p>  Cloth feed mode  Cloth feed, sewing machine thread trimming and center knife mode  Cloth feed, sewing machine thread trimming  Cloth feed, sewing machine thread trimming, center knife and corner knife mode | --- |  |
| S003 | <p>Sewing mode change-over Sewing mode is selected. * In case of alternate sewing, flap priority sewing is set with S002 .</p>  L size sewing  Left flap sewing  Right flap sewing  Flap priority sewing | --- |  |
| S004 | <p>L size setting In case of L size sewing, the sewing length is set. * It is possible to set only when setting L size sewing S003 .</p>  | 18.0 to 220.0 / 0.1mm | 150.0mm |
| S005 | <p>Marking light irradiation position change-over Sewing start irradiation/sewing end irradiation/center irradiation is selected.</p>  Sewing start irradiation  Sewing end irradiation  Center irradiation | --- |  |
| S008 | <p>Flap concealed stitching data (Left sewing start) Position of sewing start of left-hand flap is adjusted. * It is possible to set only when S003 is set to flap sewing.</p>  | -9.9 to 9.9 / 0.1mm | 0.0mm |
| S009 | <p>Flap concealed stitching data (Left sewing end) Position of sewing end of left-hand flap is adjusted. * It is possible to set only when S003 is set to flap sewing.</p>  | -9.9 to 9.9 / 0.1mm | 0.0mm |
| S010 | <p>Flap concealed stitching data (Right sewing start) Position of sewing start of right-hand flap is adjusted. * It is possible to set only when S003 is set to flap sewing.</p>  | -9.9 to 9.9 / 0.1mm | 0.0mm |







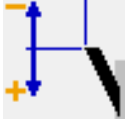
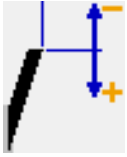
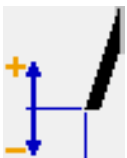

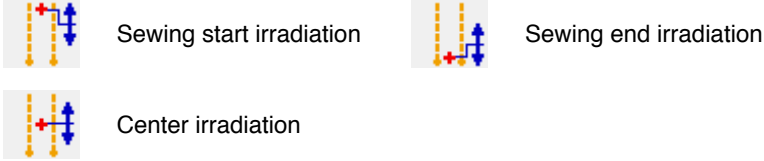
 ... Item that is not displayed due to other setting state

| No. | Item | Setting range / Edit unit | Initial value |
|--------------|---|---------------------------|---|
| S011 | Flap concealed stitching data (Right sewing end) Position of sewing end of right-hand flap is adjusted. * It is possible to set only when S003 is set to flap sewing.  | -9.9 to 9.9 / 0.1mm | 0.0mm |
| S013 | Changeover of deflection direction at the start of sewing Changeover of deflection direction at the start of sewing is performed.  | --- |  |
| S014 | Deflection amount at the start of sewing In case the start of sewing is the slant sewing setting, deflection amount is compensated. In case the start of sewing is the parallel sewing setting, deflection amount cannot be compensated.  | 0.5 to 10.0 / 0.1mm | 0.0mm |
| S015 | Changeover of deflection direction at the end of sewing Changeover of deflection direction at the end of sewing is performed.  | --- |  |
| S016 | Deflection amount at the end of sewing In case the end of sewing is the slant sewing setting, deflection amount is compensated. In case the end of sewing is the parallel sewing setting, deflection amount cannot be compensated.  | 0.5 to 10.0 / 0.1mm | 0.0mm |
| S017 S018 | Center knife actuating position setting Cutting position of center knife at sewing start/sewing end is set. * Be sure to adjust with every gauge so that the position meets the top of letter V of corner knife.  Sewing start center knife position  Sewing end center knife position | 0.0 to 25.0 / 0.1mm | 7.0mm |
| S019 | Corner knife actuating position at sewing start Cutting position of corner knife at sewing start is set.  | -9.9 to 9.9 / 0.1mm | 0.0mm |
| S020 | Corner knife actuating position at sewing end Cutting position of corner knife at sewing end is set.  | -9.9 to 9.9 / 0.1mm | 0.0mm |

 ... Item that is not displayed due to other setting state











| No. | Item | Setting range / Edit unit | Initial value |
|------|---|---------------------------|---------------|
| S021 | Setting of right width of corner knife at the start of sewing Right width of corner knife at the start of sewing is set.  | -1.0 to 1.5mm / 0.1mm | 0.5mm |
| S022 | Setting of left width of corner knife at the start of sewing Left width of corner knife at the start of sewing is set.  | -1.0 to 1.5mm / 0.1mm | 0.5mm |
| S023 | Setting of right width of corner knife at the end of sewing Right width of corner knife at the end of sewing is set.  | -1.0 to 1.5mm / 0.1mm | 0.5mm |
| S024 | Setting of left width of corner knife at the end of sewing Left width of corner knife at the end of sewing is set.  | -1.0 to 1.5mm / 0.1mm | 0.5mm |

| No. | Item | Setting range / Edit unit | Initial value |
|---|--|--|---------------|
| S025 | Setting of (left) corner knife motion position at the start of sewing Motion (longitudinal) position of left corner knife at the start of sewing is set.  | -9.9 to 9.9mm / 0.1mm | 0.0mm |
| S026 | Setting of (right) corner knife motion position at the start of sewing Motion (longitudinal) position of right corner knife at the start of sewing is set.  | -9.9 to 9.9mm / 0.1mm | 0.0mm |
| S027 | Setting of (left) corner knife motion position at the end of sewing Motion (longitudinal) position of left corner knife at the end of sewing is set.  | -9.9 to 9.9mm / 0.1mm | 0.0mm |
| S028 | Setting of (right) corner knife motion position at the end of sewing Motion (longitudinal) position of right corner knife at the end of sewing is set.  | -9.9 to 9.9mm / 0.1mm | 0.0mm |
| S030 S031 S032 | Marking light setting Marking light irradiation position in each case of sewing start irradiation/ sewing end irradiation/center irradiation is set. When set value 0.0mm, the sewing position is the same as the marking light irradiation position. Use this function when irradiating the marking light to the position that is different from the sewing position.  | -100.0 to 100.0 * Sewing start irradiation : -80.0 to 100.0 / 0.1mm | 0.0mm |



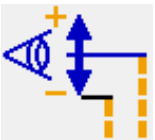
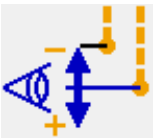



| No. | Item | Setting range / Edit unit | Initial value |
|------|---|---------------------------|--|
| S033 | <p>Automatic detection function of deflection at the start of sewing</p> <p>Flap is read at the start of sewing using two flap sensors and deflection is automatically set.</p> <p>* When SA134 Right flap angle detection device is not mounted, left flap (double welt and single welt with one side flap) only can be used.</p>  | --- | |
| S034 | <p>Automatic detection function of deflection at the end of sewing</p> <p>Flap is read at the end of sewing using two flap sensors and deflection is automatically set.</p> <p>* When SA134 Right flap angle detection device is not mounted, left flap (double welt and single welt with one side flap) only can be used.</p>  | --- | |
| S069 | <p>Roller stacker stop/motion change-over</p> <p>Stop/motion of roller stacker is selected.</p> <p>* It is displayed only when SP047 is set to roller stacker mounting.</p>  Stop  Motion | --- |  |
| S070 | <p>Clamp bar stacker stop/motion change-over</p> <p>Stop/motion of clamp bar stacker is selected.</p> <p>* It is displayed only when SP046 is set to clamp bar stacker mounting.</p>  Stop  Motion | --- |  |

 ... Item that is not displayed due to other setting state









② Items that are displayed in the sewing data list screen

| No. | Item | Setting range / Edit unit | Initial value |
|-------------|---|---------------------------|---|
| S002 | <p>Flap priority sewing selection Flap priority sewing mode is selected. * It is possible to set only when alternate sewing mode is set.</p>  Flap priority sewing prohibited  Flap priority sewing mode | --- |  |
| S006 | <p>Selection of automatic changeover of marking light irradiation position When S005 is sewing start irradiation or sewing end irradiation, the marking irradiation position is automatically changed over after end of sewing. * This function does not move at the time of alternate sewing mode and cycle sewing mode.</p>  Stop  Motion | --- |  |
| S012 | <p>Flap forced stop data When flap sewing end is not detected, the machine stops after sewing as long as the set length from rear reference position. * It is possible to set only when S003 is set to flap sewing.</p>  | 0.0 to 10.0 / 0.1mm | 5.0mm |
| S037 | <p>Compensation value of deflection detection at the start of sewing Further compensation is performed to the deflection automatically detected at the start of sewing.</p>  | -9.9 to 9.9mm / 0.1mm | 0.0mm |
| S038 | <p>Compensation value of deflection detection at the end of sewing Further compensation is performed to the deflection automatically detected at the end of sewing.</p>  | -9.9 to 9.9mm / 0.1mm | 0.0mm |
| S040 | <p>Lockstitch pitch Sewing pitch of lockstitch section is set.</p>  | 2.0 to 3.4 / 0.1mm | 2.5mm |
| S041 | <p>Selection of condensation/back tack at sewing start Condensation/back tack at sewing start is selected.</p>  Condensation  Back tack | --- |  |







 ... Item that is not displayed due to other setting state

| No. | Item | Setting range / Edit unit | Initial value |
|-------------|---|---------------------------|---------------|
| S042 | <p>Number of condensation stitches at sewing start</p> <p>Number of condensation stitches at sewing start is set.</p> <p>* It is possible to set only when S041 is set to selection of condensation.</p>  | 3 to 19 / 1 stitch | 5 stitches |
| S043 | <p>Condensation pitch at sewing start</p> <p>Condensation sewing pitch at sewing start is set.</p> <p>* It is possible to set only when S041 is set to selection of condensation.</p>  | 0.5 to 1.5 / 0.1mm | 1.0mm |
| S044 | <p>First stitch pitch of condensation sewing at sewing start</p> <p>First stitch pitch of condensation sewing at sewing start is set.</p> <p>* It is possible to set only when S041 is set to selection of condensation.</p> <p>* It is possible to set only when U024 is set to selection of condensation/back tack detailed setting.</p> <p>* It is possible to set only when the start of sewing is parallel.</p>  | 0.1 to 1.5 / 0.1mm | 1.0mm |
| S045 | <p>Second stitch pitch of condensation sewing at sewing start</p> <p>Second stitch pitch of condensation sewing at sewing start is set.</p> <p>* It is possible to set only when S041 is set to selection of condensation.</p> <p>* It is possible to set only when U024 is set to selection of condensation/back tack detailed setting.</p> <p>* It is possible to set only when the start of sewing is parallel.</p>  | 0.1 to 1.5 / 0.1mm | 1.0mm |
| S046 | <p>Third stitch pitch of condensation sewing at sewing start</p> <p>Third stitch pitch of condensation sewing at sewing start is set.</p> <p>* It is possible to set only when S041 is set to selection of condensation.</p> <p>* It is possible to set only when U024 is set to selection of condensation/back tack detailed setting.</p> <p>* It is possible to set only when the start of sewing is parallel.</p>  | 0.1 to 1.5 / 0.1mm | 1.0mm |
| S047 | <p>Number of back tack stitches at sewing start</p> <p>Number of back tack stitches at sewing start is set.</p> <p>* It is possible to set only when S041 is set to selection of back tack.</p>  | 1 to 12 / 1 stitch | 3 stitches |
| S048 | <p>Back tack pitch at sewing start</p> <p>Back tack sewing pitch at sewing start is set.</p> <p>* It is possible to set only when S041 is set to selection of back tack.</p>  | 0.5 to 3.0 / 0.1mm | 2.0mm |







 ... Item that is not displayed due to other setting state

| No. | Item | Setting range / Edit unit | Initial value |
|-------------|---|---------------------------|---|
| S049 | Back tack tie stitch pitch at sewing start Back tack tie stitch at sewing start is set. * It is possible to set only when S041 is set to selection of back tack.  | -2.0 to 2.0 / 0.1mm | -1.5mm |
| S050 | First stitch pitch of return of back tack at sewing start First stitch pitch of return section of back tack sewing at sewing start is set. * It is possible to set only when S041 is set to selection of back tack. * It is possible to set only when U024 is set to selection of condensation/back tack detailed setting. * It is possible to set only when the start of sewing is parallel.  | 0.1 to 3.0 / 0.1mm | 2.0mm |
| S051 | Second stitch pitch of return of back tack at sewing start Second stitch pitch of return section of back tack sewing at sewing start is set. * It is possible to set only when S041 is set to selection of back tack. * It is possible to set only when U024 is set to selection of condensation/back tack detailed setting. * It is possible to set only when the start of sewing is parallel.  | 0.1 to 3.0 / 0.1mm | 2.0mm |
| S052 | Third stitch pitch of return of back tack at sewing start Third stitch pitch of return section of back tack sewing at sewing start is set. * It is possible to set only when S041 is set to selection of back tack. * It is possible to set only when U024 is set to selection of condensation/back tack detailed setting. * It is possible to set only when the start of sewing is parallel.  | 0.1 to 3.0 / 0.1mm | 2.0mm |
| S054 | Selection of condensation/back tack at sewing end Selection of condensation/back tack at sewing end is performed.  Condensation  Back tack | --- |  |
| S055 | Back tack pitch at sewing start Back tack sewing pitch at sewing start is set. * It is possible to set only when S054 is set to selection of back tack.  | 3 to 19 / 1 stitch | 5 stitches |
| S056 | Condensation pitch at sewing end Condensation sewing pitch at sewing end is set. * It is possible to set only when S054 is set to selection of condensation.  | 0.5 to 1.5 / 0.1mm | 1.0mm |











 ... Item that is not displayed due to other setting state

| No. | Item | Setting range / Edit unit | Initial value |
|-------------|---|---------------------------|---------------|
| S057 | <p>The last stitch pitch of condensation</p> <p>The last stitch pitch of condensation sewing at sewing end is set.</p> <ul style="list-style-type: none"> * It is possible to set only when S054 is set to selection of condensation. * It is possible to set only when U024 is set to selection of condensation/back tack detailed setting. * It is possible to set only when the start of sewing is parallel.  | 0.1 to 1.5 / 0.1mm | 1.0mm |
| S058 | <p>Pitch of one stitch before the last stitch of condensation</p> <p>Pitch of one stitch before the last stitch of condensation sewing at sewing end is set.</p> <ul style="list-style-type: none"> * It is possible to set only when S054 is set to selection of condensation. * It is possible to set only when U024 is set to selection of condensation/back tack detailed setting. * It is possible to set only when the start of sewing is parallel.  | 0.1 to 1.5 / 0.1mm | 1.0mm |
| S059 | <p>Pitch of two stitches before the last stitch of condensation</p> <p>Pitch of two stitches before the last stitch of condensation sewing at sewing end is set.</p> <ul style="list-style-type: none"> * It is possible to set only when S054 is set to selection of condensation. * It is possible to set only when U024 is set to selection of condensation/back tack detailed setting. * It is possible to set only when the start of sewing is parallel.  | 0.1 to 1.5 / 0.1mm | 1.0mm |
| S060 | <p>Number of back tack stitches at sewing end</p> <p>Number of back tack stitches at sewing end is set.</p> <ul style="list-style-type: none"> * It is possible to set only when S054 is set to selection of back tack.  | 1 to 12 / 1 stitch | 3 stitches |
| S061 | <p>Back tack pitch at sewing end</p> <p>Back tack sewing pitch at sewing end is set.</p> <ul style="list-style-type: none"> * It is possible to set only when S054 is set to selection of back tack.  | 0.5 to 3.0 / 0.1mm | 2.0mm |
| S063 | <p>First stitch pitch of return of back tack at sewing end</p> <p>First stitch pitch of return section of back tack sewing at sewing end is set.</p> <ul style="list-style-type: none"> * It is possible to set only when S054 is set to selection of back tack. * It is possible to set only when U024 is set to selection of condensation/back tack detailed setting. * It is possible to set only when the start of sewing is parallel.  | 0.1 to 3.0 / 0.1mm | 2.0mm |

 ... Item that is not displayed due to other setting state

| No. | Item | Setting range / Edit unit | Initial value |
|-------------|--|---------------------------|---------------|
| S064 | <p>Second stitch pitch of return of back tack sewing at sewing end</p> <p>Second stitch pitch of return section of back tack sewing at sewing end is set.</p> <ul style="list-style-type: none"> * It is possible to set only when S054 is set to selection of back tack. * It is possible to set only when U024 is set to selection of condensation/back tack detailed setting. * It is possible to set only when the start of sewing is parallel.  | 0.1 to 3.0 / 0.1mm | 2.0mm |
| S065 | <p>Third stitch pitch of return of back tack sewing at sewing end</p> <p>Third stitch pitch of return section of back tack sewing at sewing end is set.</p> <ul style="list-style-type: none"> * It is possible to set only when S054 is set to selection of back tack. * It is possible to set only when U024 is set to selection of condensation/back tack detailed setting. * It is possible to set only when the start of sewing is parallel.  | 0.1 to 3.0 / 0.1mm | 2.0mm |
| S067 | <p>The last stitch pitch of back tack at sewing end</p> <p>The last stitch pitch of back tack at sewing end is set.</p> <ul style="list-style-type: none"> * It is possible to set only when S054 is set to selection of back tack.  | -2.0 to 2.0 / 0.1mm | -1.5mm |
| S068 | <p>Compensation of back tack return at sewing end</p> <p>Compensation value of back tack return at sewing end is set.</p> <ul style="list-style-type: none"> * It is possible to set only when S054 is set to selection of back tack. * It is possible to set only when K061 compensates with pattern data.  | -2.0 to 2.0 / 0.1mm | 1.0mm |
| S071 | <p>Stacking position</p> <p>After moving clamp foot as far as the set distance from the position of corner knife, stacker is actuated. (+ : rear side, - : front side)</p> <ul style="list-style-type: none"> * Range of actuating amount is limited by the position of clamp foot at the time of sewing end. * Use SP046 clamp bar stacker or SP047 roller stacker. In addition, it is possible to set only when S069 roller stacker motion setting or S070 clamp bar stacker motion setting is performed.  | -500 to 500mm / 1mm | 0mm |
| S072 | <p>Stacker timer 1</p> <p>Roller rotation time is set. When material sensor has detected without material before setting time, rotation stops.</p> <ul style="list-style-type: none"> * SP047 roller stacker option is used and it is possible to set only when S069 roller stacker motion is set.  | 0.0 to 9.9 / 0.1 sec. | 0.5 sec. |
| S073 | <p>Jump feed speed up to the position of sewing start</p> <p>Jump feed speed up to the position of sewing start is set.</p>  | 3 to 10 / 1 | 5 |

 ... Item that is not displayed due to other setting state

| No. | Item | Setting range / Edit unit | Initial value |
|-------------|--|---------------------------------|---|
| S074 | Jump feed speed up to the position of corner knife Jump feed speed up to the position of corner knife is set.  | 3 to 10 / 1 | 5 |
| S075 | Dart stretcher device stop/motion change-over Stop/motion of dart stretcher device is selected. * It is possible to set only when SA117 dart stretcher option is used.  Stop  Motion | --- |  |
| S076 | Automatic interlining supplying device stop/motion change-over Stop/motion of automatic interlining supplying device is selected. * It is possible to set only when SA120 automatic interlining supplying option is used. * Regarding the interlining supplying, when the pattern is not used, be careful not to make the interlining come out from the top surface of the table. When using next, press once the feeding button on the panel and perform the feeding motion to cut.  Stop  Motion | --- |  |
| S077 | Flap length Length of flap is set. It is possible to set only when S076 automatic interlining supplying device is selected to motion and S003 sewing mode changeover is selected to flap sewing. * This setting is set to determine the interlining feeding length of automatic interlining supplying device. Sewing length is determined by the detection of flap sensor.  | 37.0 to 220.0 / 0.1mm | 150.0mm |
| S078 | Sewing speed under the high-speed mode Number of revolutions at lockstitch section is set. * It is possible to set only when K059 sewing speed setting selection is set to pattern data selection.  | 1000 to 3000 / 100sti/min | 2500sti/min |
| S079 | Sewing speed under the low-speed mode Number of revolutions at condensation and back tack sewing sections is set. * It is limited by S078 sewing speed under the high-speed mode. * It is possible to set only when K059 sewing speed setting selection is set to the selection of pattern data.  | 1000 to 2500 / 100sti/min | 1500sti/min |

 ... Item that is not displayed due to other setting state

(3) Copying function of the upper and lower alternate sewing data

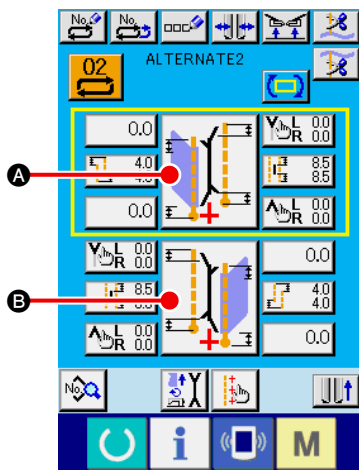

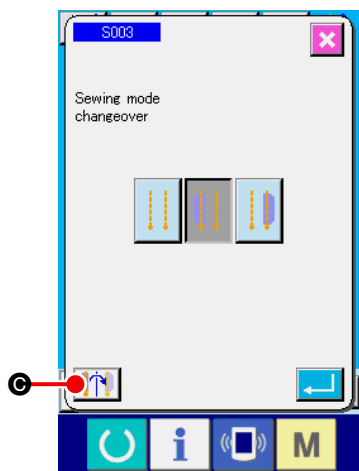

- ① **Display the alternate sewing input screen.**
When the input screen of the alternate sewing mode is displayed, it is possible to copy the upper and lower data.
- ② **Call the sewing mode changeover screen.**
Press SEWING MODE SETTING button to display the sewing mode changeover screen. When you desire to copy the upper sewing data to the lower sewing data, press button **B** on the lower side and you desire to copy the lower sewing data to the upper sewing data, press button **A** on the upper side.

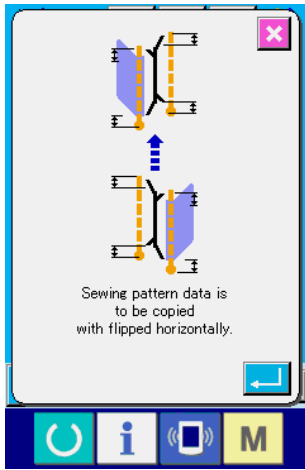

- ③ **Copy the alternate sewing data.**
Press UPPER/LOWER SEWING DATA COPY button  **C** in the sewing mode changeover screen.



④ **Start copying.**

When ENTER button  is pressed in the copy confirmation screen, the left and right sewing data are inversely copied. When CANCEL button  is pressed, the screen returns to the original sewing mode changeover screen without copying.

* The sewin data below are inversed from the left to the right at the time of copying. (Other sewing data are copied without inversion.)

| No. | Item |
|------|--|
| S003 | Sewing mode changeover |
| S008 | Flap concealed stitching data (Left sewing start) |
| S009 | Flap concealed stitching data (Left sewing end) |
| S010 | Flap concealed stitching data (Right sewing start) |
| S011 | Flap concealed stitching data (Right sewing end) |
| S013 | Changeover of deflection direction at the start of sewing |
| S015 | Changeover of deflection direction at the end of sewing |
| S021 | Setting of right width of corner knife at the start of sewing |
| S022 | Setting of left width of corner knife at the start of sewing |
| S023 | Setting of right width of corner knife at the end of sewing |
| S024 | Setting of left width of corner knife at the end of sewing |
| S025 | Setting of (left) corner knife motion position at the start of sewing |
| S026 | Setting of (right) corner knife motion position at the start of sewing |
| S027 | Setting of (left) corner knife motion position at the end of sewing |
| S028 | Setting of (right) corner knife motion position at the end of sewing |

9. CHANGING THE MEMORY SWITCH DATA

(1) Changing procedure of the memory switch data

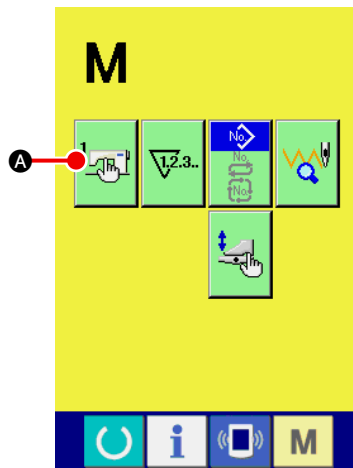



① Display the memory switch data list screen

Press MODE CHANGE-OVER key **M** and the memory switch

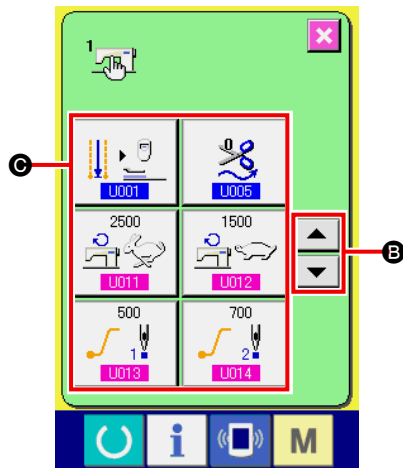
button  **A** is displayed. When this button is pressed, the memory switch data list (screen A) is displayed.



② Select the memory switch button you desire to change





Press UP/DOWN SCROLL button  or  **B** and select DATA ITEM button **C** you desire to change.

Memory switch data list screen
(Screen A)





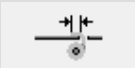
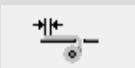
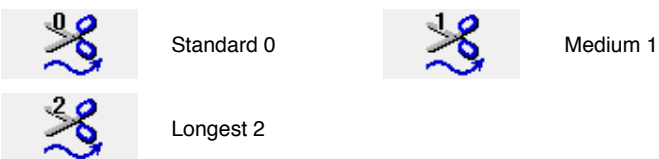



(2) Memory switch data list

① Level 1











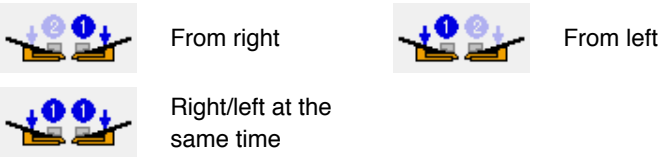

Memory switch data (level 1) are the motion data that the sewing machine has in common and the data that operate on all sewing patterns in common.

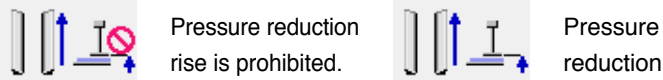
| No. | Item | Setting range / Edit unit | Initial value |
|-------------|--|---------------------------|---|
| U001 | <p>Change-over of the position of clamp foot after sewing end Position of clamp foot after sewing end is selected from Stop at front end/Return to medium/Clamp return/Stop at rear end.</p>  | --- |  |
| U002 | <p>Front end motion start waiting time Waiting time up to the start of front end motion of clamp foot is set. * It is possible to set only when U001 is set to the stop at front end.</p>  | 0.50 to 9.99 / 0.01 sec. | 3.00 sec. |
| U003 | <p>Number of times of feeding of automatic interlining supplying at sewing start Number of times of feeding of automatic interlining supplying device at sewing start is set. * It is possible to set only when SA120 automatic interlining supplying option is used.</p>  | 2 to 9 / 1 | 3 |
| U004 | <p>Feeding length of automatic interlining supplying at sewing end Feeding length of automatic interlining supplying device at sewing end is set. * It is possible to set only when SA120 automatic interlining supplying device is used.</p>  | 0 to 99.9 / 0.1mm | 0mm |
| U005 | <p>Thread trimming timing Thread trimming timing after sewing is selected from Standard/Medium/Longest and length of thread at sewing end is adjusted.</p>  <p>* When SA125 Ready-made zipper device is mounted and the setting is set to standard value "0", needle thread may not be cut.</p> | --- |  |
| U007 | <p>Stacker timer 2 Waiting time from the start of clamp motion to hold material on the stacker base to release the material presser is set. * It is possible to set only when SP046 clamp bar stacker option is used.</p> | 0.00 to 9.99 / 0.01 sec. | 0.70 sec. |









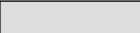

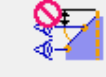







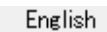
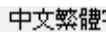
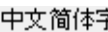



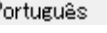
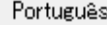
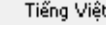
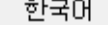



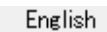
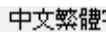
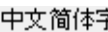

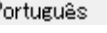
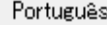
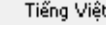
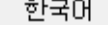

... Item that is not displayed due to other setting state.

| No. | Item | Setting range / Edit unit | Initial value |
|------|--|----------------------------|---|
| U008 | Stacker timer 3 Motion time of material sweeping bar is set. * It is possible to set only when SP046 clamp bar stacker option is used. | 0.00 to 9.99 / 0.01 sec. | 0.70 sec. |
| U009 | Stacker timer 4 Time to advance timing to release the sewing product by lifting clamp foot is set. When clamping a short sewing product, the amount to drop by tare is adjusted. * It is possible to set only when SP046 clamp bar stacker option is used. | 0.00 to 9.99 / 0.01 sec. | 0.00 sec. |
| U011 | Sewing speed under the high-speed mode Number of revolutions of lockstitch section is set. * It is possible to set only when K059 sewing speed setting selection is set to memory switch. | 1000 to 3000 / 100 sti/min | 2500sti/min |
| U012 | Sewing speed under the low-speed mode Number of revolutions of condensation and back tack sewing sections is set. * It is limited by U011 sewing speed under the high-speed mode. * It is possible to set only when K059 sewing speed setting selection is set to memory switch. | 1000 to 2500 / 100 sti/min | 1500sti/min |
| U013 | Soft start, first stitch Number of revolutions of first stitch at sewing start is limited. | 500 to 2500 / 100 sti/min | 500sti/min |
| U014 | Soft start, second stitch Number of revolutions of second stitch at sewing start is limited. | 500 to 2500 / 100 sti/min | 700sti/min |
| U015 | Soft start, third stitch Number of revolutions of third stitch at sewing start is limited. | 500 to 2500 / 100 sti/min | 1000sti/min |
| U016 | Return speed of clamp foot Return speed of clamp foot is set. | 3 to 9 / 1 | 7 |
| U017 | Thread breakage detection With/without thread breakage detection is selected.  With thread breakage detection  Without thread breakage detection | --- |  |
| U018 | Flap presser motion mode Motion order of flap presser is selected.  From right  From left  Right/Left at same time  Side where flap is put * When right and left are simultaneously actuated with customizing of pedal setting, this parameter is neglected and the right and left are simultaneously actuated. | |  |

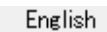
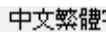
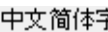
... Item that is not displayed due to other setting state.

| No. | Item | Setting range / Edit unit | Initial value |
|-------------|--|---------------------------|---|
| U019 | <p>Clamp foot down order change-over Lowering order of clamp foot is selected.</p>  <p>* When right and left are simultaneously actuated with customizing of pedal setting, this parameter is neglected and the right and left are simultaneously actuated.</p> | --- |  |
| U020 | <p>Folding plate motion mode "Return/No return" of folding plate when corner knife projects is selected.</p>  | --- |  |
| U021 | <p>Binder pressure reduction rise prohibition Pressure reduction rise of the binder at the time of jump feed is prohibited.</p>  | --- |  |
| U022 | <p>Standing pedal continuous depressing timer effective/ineffective change-over Effective/ineffective of U023 standing pedal continuous depressing timer is selected. * It is possible to set only when K054 one-shot pedal is set.</p>  | --- |  |
| U023 | <p>Standing pedal continuous depressing timer When performing sewing product setting work with the standing pedal depressed, the time interval when the respective devices operate in order is set. * It is possible to set only when K054 one-shot pedal is set.</p>  | 0.1 to 2.0 / 0.1 sec. | 0.5 sec. |
| U024 | <p>Condensation/back tack detailed setting Detailed setting "Perform/Not perform" of pitch of condensation/back tack section is selected.</p>  | --- |  |
| U025 | <p>Flap stopper position In case of flap sewing, sewing start irradiation position of marking light (distance from needle) is set * Setting is only the irradiation position of marking light. Actual sewing position is the flap end position detected by the flap sensor.</p>  | 80.0 to 280.0 / 0.1mm | 80.0mm |

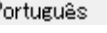
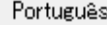
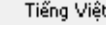
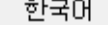



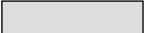









 . . . Item that is not displayed due to other setting state.

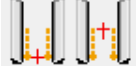









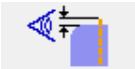
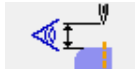
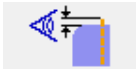





| No. | Item | Setting range / Edit unit | Initial value | | | | | | | | | | | | | | | | | | | | | | | | | | | | | | | | |
|---|--|--|--|---|--|----------|---------|-----------------------|----------------------|---|--|--|--|---------|---------|--------|--------|---|---|--|--|------------|------------|------------|--------|---|---|--|--|------------|---------|--|--|-----|--------------|
| U026 | <p>Changeover of compensation of flap concealed stitching position using deflection detection</p> <p>When the automatic deflection detection of left flap is not set, compensation of flap concealed stitching is automatically performed using the second flap sensor.</p> <p>* When the automatic deflection detection is set, compensation of flap concealed stitching is automatically performed regardless of with/without this setting.</p>  Used  Not used | --- |  | | | | | | | | | | | | | | | | | | | | | | | | | | | | | | | | |
| U027 | <p>Changeover of right/wrong side of material in the corner knife setting screen</p> <p>Material displayed in the corner knife setting screen is selected to right side display or wrong side display.</p>  Right side display  Wrong side display | --- |  | | | | | | | | | | | | | | | | | | | | | | | | | | | | | | | | |
| U028 | <p>Stacker timer 5</p> <p>Sets the waiting time of the stacker from the start of material grasping operation to the release of the material</p> <p>This setting is available when SP048 "Grasping stacker (optional)" is used.</p>  | 0.00 - 9.99/ 0.01 sec | 1.00 sec | | | | | | | | | | | | | | | | | | | | | | | | | | | | | | | | |
| U029 | <p>Stacker timer 6</p> <p>Sets the duration of operating the oscillating arm</p> <p>This setting is available when SP048 "Grasping stacker (optional)" is used.</p>  | 0.00 - 9.99/ 0.01 sec | 1.50 sec | | | | | | | | | | | | | | | | | | | | | | | | | | | | | | | | |
| U245 | <p>Number of stitches of grease-up</p> <p>Number of stitches of sewing machine motion after replenishing grease is indicated.</p> <p>* When pressing CLEAR button, number of stitches is cleared to "0".</p> <p>Be sure to clear after replenishing grease.</p>  | --- | --- | | | | | | | | | | | | | | | | | | | | | | | | | | | | | | | | |
| U500 | <p>Language selection</p> <p>Language to be indicated in the panel is selected.</p> <table border="0" style="width: 100%; text-align: center;"> <tr> <td> 日本語</td> <td> English</td> <td> 中文繁體字</td> <td> 中文简体字</td> </tr> <tr> <td>Japanese</td> <td>English</td> <td>Chinese (traditional)</td> <td>Chinese (simplified)</td> </tr> <tr> <td> Español</td> <td> Italiano</td> <td> Français</td> <td> Deutsch</td> </tr> <tr> <td>Spanish</td> <td>Italian</td> <td>French</td> <td>German</td> </tr> <tr> <td> Português</td> <td> Português</td> <td> Tiếng Việt</td> <td> 한국어</td> </tr> <tr> <td>Portuguese</td> <td>Portuguese</td> <td>Vietnamese</td> <td>Korean</td> </tr> <tr> <td> Indonesia</td> <td> Русский</td> <td></td> <td></td> </tr> <tr> <td>Indonesian</td> <td>Russian</td> <td></td> <td></td> </tr> </table> |  日本語 |  English |  中文繁體字 |  中文简体字 | Japanese | English | Chinese (traditional) | Chinese (simplified) |  Español |  Italiano |  Français |  Deutsch | Spanish | Italian | French | German |  Português |  Português |  Tiếng Việt |  한국어 | Portuguese | Portuguese | Vietnamese | Korean |  Indonesia |  Русский | | | Indonesian | Russian | | | --- | No selection |
|  日本語 |  English |  中文繁體字 |  中文简体字 | | | | | | | | | | | | | | | | | | | | | | | | | | | | | | | | |
| Japanese | English | Chinese (traditional) | Chinese (simplified) | | | | | | | | | | | | | | | | | | | | | | | | | | | | | | | | |
|  Español |  Italiano |  Français |  Deutsch | | | | | | | | | | | | | | | | | | | | | | | | | | | | | | | | |
| Spanish | Italian | French | German | | | | | | | | | | | | | | | | | | | | | | | | | | | | | | | | |
|  Português |  Português |  Tiếng Việt |  한국어 | | | | | | | | | | | | | | | | | | | | | | | | | | | | | | | | |
| Portuguese | Portuguese | Vietnamese | Korean | | | | | | | | | | | | | | | | | | | | | | | | | | | | | | | | |
|  Indonesia |  Русский | | | | | | | | | | | | | | | | | | | | | | | | | | | | | | | | | | |
| Indonesian | Russian | | | | | | | | | | | | | | | | | | | | | | | | | | | | | | | | | | |













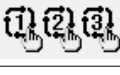
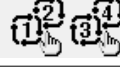
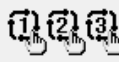

 . . . Item that is not displayed due to other setting state.





② Level 2

Memory switch data (level 1) are the motion data that the sewing machine has in common and the data that operate on all sewing patterns in common. The data are for the maintenance personnel and possible to edit by pressing the mode switch as long as 6 seconds.

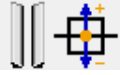
| No. | Item | Setting range / Edit unit | Initial value |
|-------------|---|---------------------------|---|
| K051 | <p>Marking light mounting Mounting/Non-mounting of marking light is selected. When “Non mounting” is selected, marking light does not work.</p>  Non mounting  Mounting | --- |  |
| K052 | <p>Sewing position selection Mode that surely ends sewing at rear reference position, mode that surely starts sewing from front reference position or the conventional motion mode that changes sewing position according to the setting of S005 is selected. * Front reference position : 80 mm from needle Rear reference position : 300 mm from needle</p>  Conventional motion mode  Sewing position fixed mode (Rear reference)  Sewing position fixed mode (Front reference) | --- |  |
| K054 | <p>Pedal operation mode change-over Mode to be used for foot pedal is set.</p>  7-step pedal mode  1-shot pedal mode | --- |  |
| K055 | <p>Excess rate of center knife cutting Excess rate in terms of the speed of revolution of center knife can be set.</p>  | 300 to 500 / 1% | 350% |
| K056 | <p>Setting of intermittent feed prohibition Perform/not perform intermittent feed sewing is selected. * When performing intermittent sewing, the max. sewing speed of sewing machine is limited 1,500 sti/min.</p>  Perform intermittent feed sewing  Not perform intermittent feed sewing | --- |  |

| No. | Item | Setting range / Edit unit | Initial value |
|-------------|--|---------------------------|---|
| K057 | <p>Change-over of flap concealed stitching data edit reference Making the flap concealed stitching data that is set from panel the compensation value from the flap detecting end or the distance from detecting sensor to sewing start is selected.</p>  Flap detecting end compensation  Sensor compensation | --- |  |
| K058 | <p>L size data range enlargement Enlarging/not enlarging L size data range to max. 220 mm + 15 mm is set.</p>  Not enlarging  Enlarging | --- |  |
| K059 | <p>Selection of sewing speed of sewing machine setting It is selected that either memory switch or pattern data performs setting of sewing speed of sewing machine.</p>  Memory switch  Pattern data | --- |  |
| K060 | <p>Selection of reflecting tape check mode ON/OFF of reflecting tape check mode is set. When ON is set, the clamp foot is automatically comes lowered with the first clamp foot advance motion after turning ON the power and deterioration check of reflecting tape is performed. * Clamp foot is automatically lowered. Be sure to use this function only in case of shim type.</p>  OFF  ON | --- |  |
| K061 | <p>Selection of back tack return at sewing end compensation setting It is selected that either memory switch or pattern data performs setting of back tack return at sewing end compensation.</p>  Memory switch  Pattern data | --- |  |
| K062 | <p>Back tack return at sewing end compensation Back tack return at sewing end compensation is set. * It is possible to set only when K061 is set to the memory switch selection.</p>  | -2.0 to 2.0 / 0.1mm | 1.0mm |
| K063 | <p>Selection of mode change-over button display in the pattern list screen Mode change-over button is displayed in the pattern list screen and data of different mode can be selected.</p>  Non-display  Display | --- |  |

| No. | Item | Setting range / Edit unit | Initial value |
|-------------|--|-----------------------------|---|
| K064 | <p>Back tack control method selection Sewing pattern of back tack can be selected.</p>  1st mode (standard) Sewing first the longer seams (Emphasis is put on sewing quality.)  2nd mode Sewing first the shorter seams (Emphasis is put on productivity.)  3rd mode 1st mode and 2nd mode are changed over according to the deflection amount.  4th mode Same specifications as those of APW-196 (Emphasis is put on speed.) <p>* 2nd mode and 4th mode do not correspond with the standard welting patch scale.</p> | --- |  |
| K066 | <p>Cycle sewing coupling function Odd-numbered pattern can be coupled to even-numbered pattern and as many as 12 steps can be sewn. Only combination of 1 and 2, 3 and 4, 5 and 6, 7 and 8, 9 and 10, 11 and 12, 13 and 14, 15 and 16, 17 and 18, and 19 and 20 can be coupled.</p>  Coupling function OFF  Coupling function ON | --- |  |
| K067 | <p>Corner knife index constant motion Normally, the long corner knife is not used unless the value is more than the specified value. However, by turning this function ON, the long corner knife is always used at the time of deflection.</p>  Constant index OFF  Constant index ON | --- |  |
| K068 | <p>Condensation control method selection Sewing pattern of condensation can be selected.</p>  1st mode (standard) Sewing first the longer seams  2nd mode Sewing first the shorter seams <p>* 2nd mode does not correspond with the standard welting patch scale.</p> | --- |  |
| K069 | <p>Center knife lowering time Center knife lowering time is set.</p>  | 10 to 100 / 1 | 40 |
| K070 | <p>Center knife one-shot motion prohibition setting With/without one-shot motion to properly cut the cutting position of center knife on the side of the end of sewing is selected.</p>  With one-shot motion  One-shot motion prohibited | --- |  |
| K080 | <p>Clamp foot motor origin compensation Origin of clamp foot motor is compensated.</p>  | -10.0 to 10.0 / 0.1mm | 0.0mm |

| No. | Item | Setting range / Edit unit | Initial value |
|------|--|---------------------------|---------------|
| K081 | <p>Corner knife motor origin compensation Origin of corner knife motor is compensated.</p>  | -5.0 to 5.0 / 0.1mm | 0.0mm |
| K082 | <p>Marking light origin compensation (just under) Origin of marking light motor is compensated. Origin is in the state that it irradiates light just under and located at the position of 230 mm from needle.</p>  | -500 to 500 / 1pulse | 0pulse |
| K083 | <p>Marking light origin compensation (needle side) Position of needle side from origin of marking light motor is compensated. Light irradiation position is 80 mm from needle.</p>  | -500 to 500 / 1pulse | 0pulse |
| K084 | <p>Marking light origin compensation (operator side) Position of operator side from origin of marking light motor is compensated. Light irradiation position is 380 mm from needle.</p>  | -500 to 500 / 1pulse | 0pulse |
| K085 | <p>Back tack motor origin compensation Origin of back tack motor is compensated.</p>  | -30 to 30 / 1pulse | 0pulse |

10. PERFORMING OPTIONAL SETTING

(1) Changing procedure of the optional setting

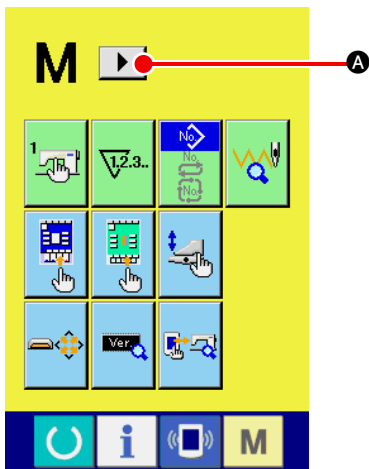

- ① **Displaying the 2nd screen of the operation-mode changeover screen.**

When you keep operation-mode changeover key **M** held pressed for six seconds, right-scroll button  **A** is displayed on the screen.

When you press this button, the 2nd screen (screen A) of the operation-mode changeover screen is displayed.

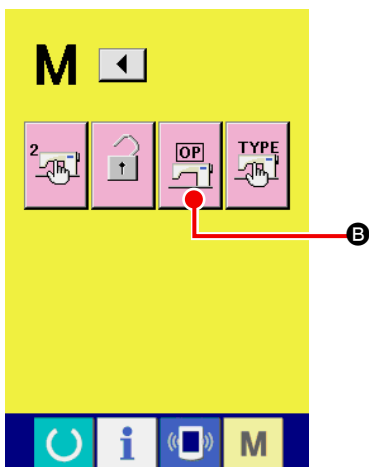

- ② **Displaying the option setting list screen**



Option setting button  **B** is displayed on the screen.

When you press this button, option setting list screen (screen B) is displayed.

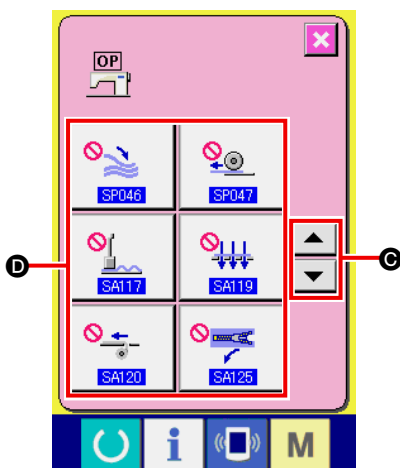
Second screen of the mode changeover screen (Screen A)















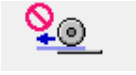

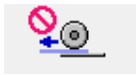





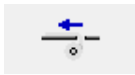
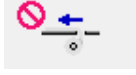

- ③ **Selecting the option setting you want to change**

Press up/down scroll buttons   **C** to select the data item button **D** you want to change.

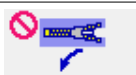
Optional setting list screen (Screen B)

(2) Optional setting list

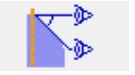
By setting the optional mounted state, it is possible to perform the respective optional operations.

| No. | Item | Setting range / Edit unit | Initial value |
|--------------|--|---------------------------|---|
| SP046 | Clamp bar stacker mounting/not mounting is set  Not mounting  Mounting | --- |  Not mounting |
| SP047 | Roller stacker mounting/not mounting is set.  Not mounting  Mounting | --- |  Not mounting |
| SP048 | Sets mount/unmount of the grasping stacker device mount/unmount  Unmount  Mount | --- |  Unmount |
| SA117 | Dart stretcher mounting/not mounting is set. * However, in case of dart stretcher mounting, M001 Gauge size setting is limited to 8 to 12 mm.  Not mounting  Mounting | --- |  Not mounting |
| SA119 | Vacuum device mounting/not mounting is set.  Not mounting  Mounting | --- |  Not mounting |
| SA120 | Automatic interlining supplying device mounting/not mounting is set.  Not mounting  Mounting | --- |  Not mounting |
| SA122 | Zipper attachment mounting/not mounting is set. * However, in case of dart stretcher mounting, M001 Gauge size setting is limited to 8 to 12 mm.  Not mounting  Mounting | --- |  Not mounting |
| SA125 | Breast pocket device mounting/not mounting is set. * However, in case of dart stretcher mounting, M001 Gauge size setting is limited to 16 to 20 mm.  Not mounting  Mounting | --- |  Not mounting |
| SA134 | Right flap angle detection device mounting/not mounting is set.  Not mounting  Mounting | --- |  Not mounting |

11. CHANGING THE DEVICE SETTING

(1) Changing procedure of the device setting

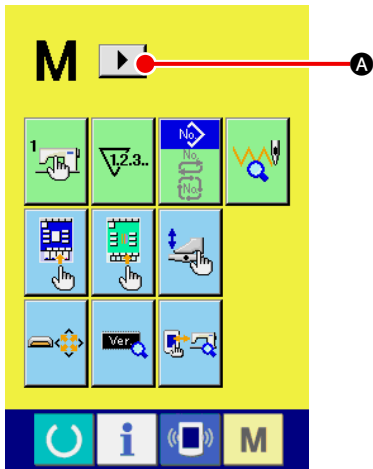

- ① **Displaying the 2nd screen of the operation-mode changeover screen.**

When you keep operation-mode changeover key **M** held pressed for six seconds, right-scroll button  **A** is displayed on the screen.

When you press this button, the 2nd screen (screen A) of the operation-mode changeover screen is displayed.

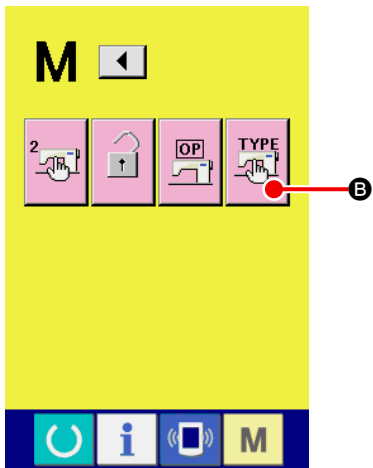

- ② **Displaying the device setting list screen**

Device setting button  **B** is displayed on the screen.

When you press this button, the device setting list screen (screen B) is displayed.

Second screen of the mode changeover screen (Screen A)

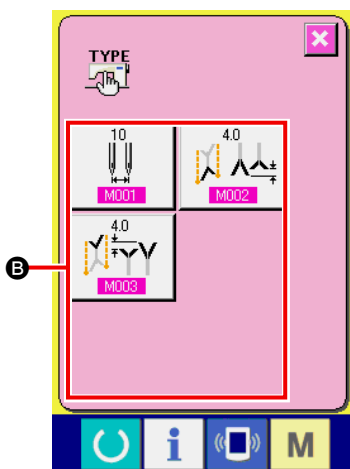



Device setting list screen (Screen B)

- ③ **Selecting the device setting you want to change**

Select the data item button  you want to change.

(2) Device setting list

By setting the type of device, it is possible to operate according to the type.

| No. | Item | Setting range / Edit unit | Initial value |
|------|---|---------------------------------|---------------|
| M001 | <p>Gauge size Gauge size of sewing machine is set.</p> <ul style="list-style-type: none"> * Corner knife motion is changed according to the set value of gauge size. * When SA117 Dart stretcher is mounted, the range is limited to 8 to 12 mm. When SA122 Breast pocket device is mounted, the range is limited to 8 to 12 mm. When SA125 Zipper attachment is mounted, the gauge size is limited to the range of 16 mm and 20 mm.  | 8 to 20 / 2mm | 10mm |
| M002 | <p>Excess cut length of index on the fixing side Excess cut length of index on the fixing side is set.</p>  | 0.0 to 16.0mm / 0.1mm | 4.0mm |
| M003 | <p>Excess cut length of index on the traveling side Excess cut length of index on the traveling side is set.</p>  | 0.0 to 16.0mm / 0.1mm | 4.0mm |

12. CUSTOMIZING THE PEDAL OPERATION

Operation functions of “Binder down”, “Flap presser down”, etc. in terms of the number of the respective depressing steps of the pedal can be optionally registered in accordance with the using conditions. In addition, the customized pedal operation data can have as many as 5 kinds. Select and use them.

(1) Method to select and use the customized data

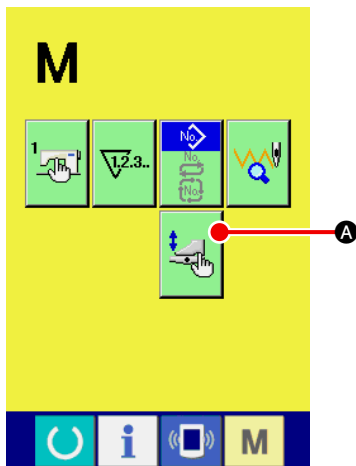

① Display the pedal customizing screen

Press MODE CHANGEOVER key **M** and PEDAL

CUSTOMIZING button  **A** is displayed on the screen.

Press this button and the pedal customizing screen (screen A) is displayed.

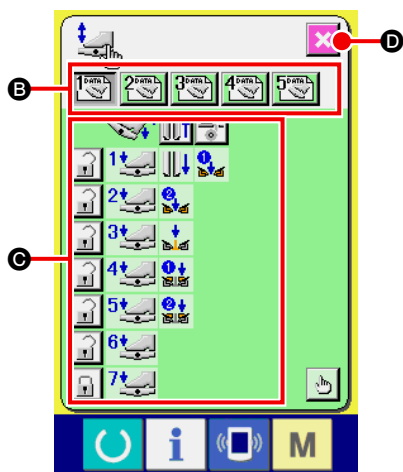



Pedal customizing screen
(Screen A)

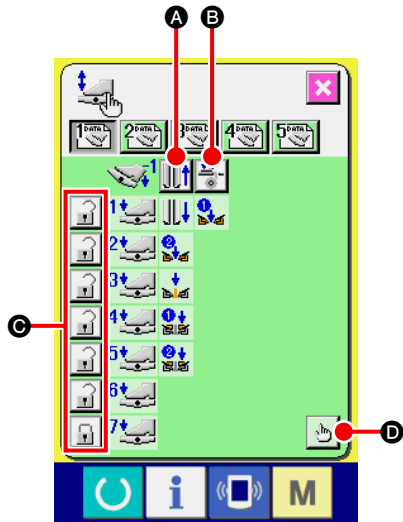

② Select from button **B** 5 kinds of pedal operation that are registered as customized. At this time, the contents of selected pedal operation data are displayed at **C**.

③ When SCREEN END button  **D** is pressed, the selected pedal operation data is determined and the screen returns to the original screen.



(2) Customizing the pedal operation data





- ① Press button  **A**, and set whether to make the clamp foot recede or not with the pedal depressed to the reverse step.

| Display | Description |
|---|-------------------------------|
|  | To make clamp foot recede |
|  | Not to make clamp foot recede |

- ② Press button  **B**, and set whether or not the interlining presser actuate with the pedal depressed to the reverse step.

| Display | Description |
|---|----------------|
|  | To actuate |
|  | Not to actuate |

- ③ Press button  **C** and set whether or not to lock the respective pedal operations of first to seventh steps.
In case of “lock”, even when the pedal is released, the motion state by pedal operation is held unless the pedal is depressed to the reverse step or reset of pedal is performed.



| Display | Description |
|---|-------------|
|  | To lock |
|  | Not to lock |



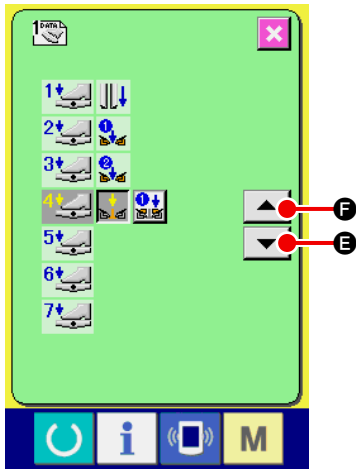

Pedal motion function setting screen
(Screen A)

- ④ Press button  **D**, and the pedal motion function setting screen (screen A) is displayed. Then the motion function to be registered to the number of the respective pedal steps can be set.



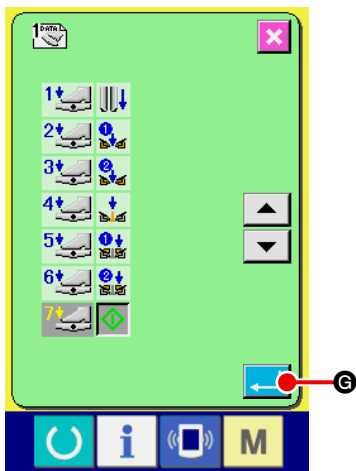





⑤ Functions below can be registered from first step in order. Functions that can be registered are in the state of button as , and displayed in order. When the button is pressed, the color changes and the function is registered. The number of pedal steps is advanced with ▲▼ button  ④. When the number of pedal steps is returned with  ⑤, it becomes the state before one.



When functions are registered up to the last, ENTER button  ⑥ is displayed. Press it to determine the registered data.

- * It is possible to clear and register the number of pedal steps.
- * When the function is determined without registering MACHINE START , knee switch start is applied.
- * Whether or not the clamp foot comes down from right or left is determined by **U019** clamp foot lowering order change-over. When right and left are set to the same time, even if the independent motion is set in this screen, the right and the left actuate at the same time.
- * Whether or not the flap presser comes down from right or left is determined by **U018** flap presser lowering order change-over. When right and left are set to the same time, even if the independent motion is set in this screen, the right and the left actuate at the same time.

| Display | Description | Display | Description |
|---|--------------------------------|---|----------------------------------|
|  | Dart stretcher (optional) |  | Binder down |
|  | Vacuum suction |  | Flap presser one side down |
|  | Clamp foot one side down |  | Flap presser remaining side down |
|  | Clamp foot remaining side down |  | Machine start |

13. CUSTOMIZING THE DATA INPUT SCREEN

Buttons displayed in the data input screen can be customized in accordance with the customers' using conditions.

(1) Customizing procedure

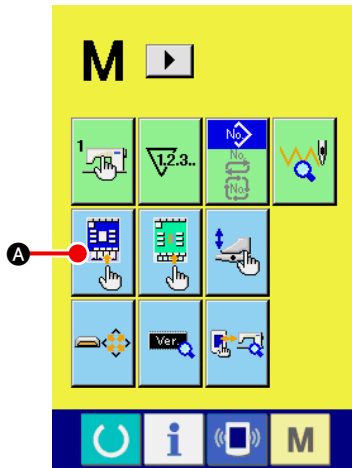

① Display the customizing screen of the input screen

Keep pressing MODE CHANGEOVER key **M** for three

seconds, and CUSTOMIZE button **A** is displayed on the screen.

When this button is pressed, the customizing screen of the input screen is displayed.

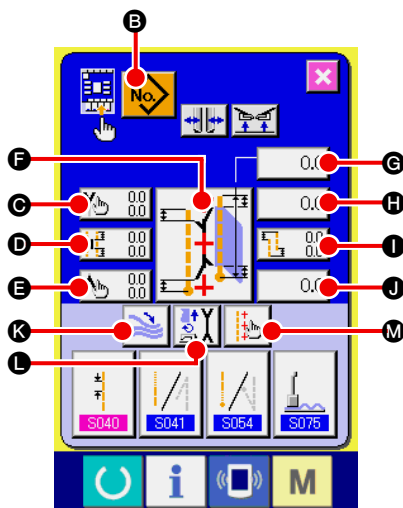

② Select the conditions of buttons

Every time the buttons from **B** to **M** are pressed, display/non display of the buttons can be changed over. Customize and use the buttons in accordance with the customers' using conditions.

| Symbol | Display | Non display | Description | Initial state |
|----------|---------|-------------|---|---------------|
| B | | | Pattern list button | Display |
| C | | | Flap concealed stitching data (Left sewing start) | Display |
| D | | | Center knife motion position setting | Display |
| E | | | Flap concealed stitching data (Left sewing end) | Display |
| F | | | Sewing mode change-over | Display |
| G | | | L size setting | Display |
| H | | | Corner knife motion position at sewing start | Display |
| I | | | Deflection amount setting | Display |
| J | | | Corner knife motion position at sewing end | Display |
| K | | | Stacker stop/motion change-over | Display |
| L | | | Motion mode change-over | Display |
| M | | | Marking light setting | Display |

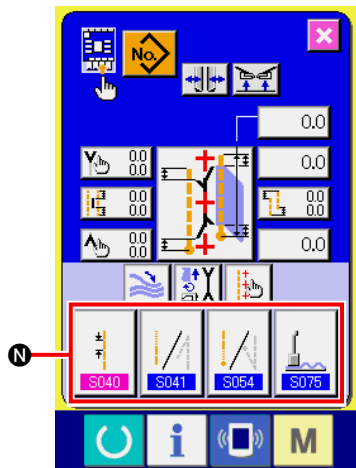

③ **Register the sewing data to SEWING DATA CUSTOMIZING button**

Up to 4 sewing data can be registered to SEWING DATA CUSTOMIZE buttons **N**.

Register and use the sewing data that are frequently used.

When pressing CUSTOMIZING button **N** you desire to register, the sewing data list (screen A) is displayed.

④ **Select the sewing data to be registered**

Select the sewing data you desire to register with SEWING DATA button **O**.

When the selected button is pressed twice, the selection is released.

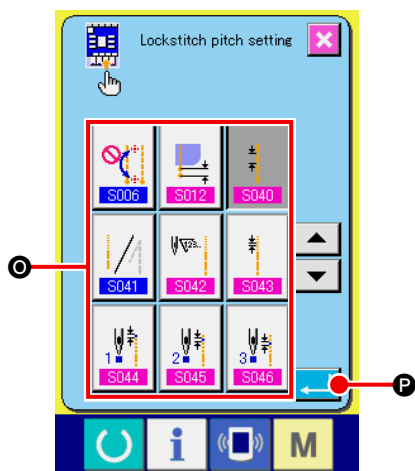

⑤ **Register the data to the customizing button**

When ENTER button **P** is pressed, register to the customizing button ends, and the screen returns to the customizing screen of the input screen.

The registered sewing data is displayed on CUSTOMIZING button **N**.

**Sewing data list screen
(Screen A)**

The data below have been registered in order from the left at the time of your purchase.

| | | |
|----|--|--|
| a. | | Lockstitch pitch |
| b. | | Condensation/back tuck at sewing start selection |
| c. | | Condensation/back tuck at sewing end selection |
| d. | | Dart stretcher stop/motion change-over |

14. PERFORMING THE CUSTOMIZING SETTING OF THE SEWING SCREEN

Buttons displayed in the data input screen can be customized in accordance with the customers' using conditions.

(1) Customizing procedure

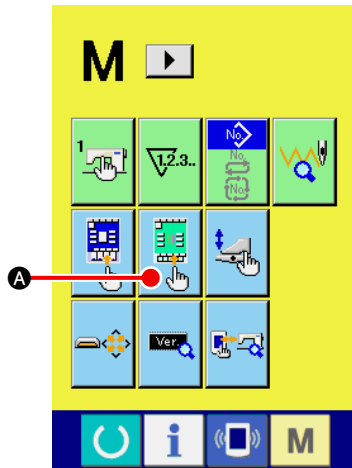

① Display the customizing screen of the sewing screen

Keep pressing MODE CHANGEOVER key **M** for three

seconds and SEWING SCREEN CUSTOMIZING button **A**



is displayed on the screen.

Press this button and the customizing screen of sewing screen is displayed.

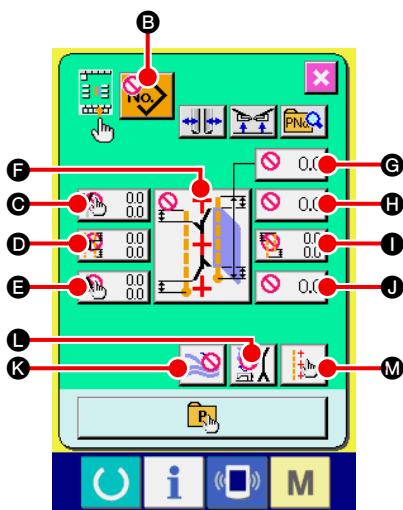

② Set the conditions of buttons

Every time the buttons from **B** to **M** are pressed, button display/non display can be changed over. Customize and use the buttons in accordance with the customers' using conditions.

| Symbol | Display | Non display | Description | Initial state |
|--------|---------|-------------|---|---------------|
| B | | | Pattern list button | Non display |
| C | | | Flap concealed stitching data (Left sewing start) | Non display |
| D | | | Center knife motion position setting | Non display |
| E | | | Flap concealed stitching data (Left sewing end) | Non display |
| F | | | Sewing mode change-over | Non display |
| G | | | L size setting | Non display |
| H | | | Corner knife motion position at sewing start | Non display |
| I | | | Deflection amount setting | Non display |
| J | | | Corner knife motion position at sewing end | Non display |
| K | | | Stacker stop/motion change-over | Non display |
| L | | | Motion mode change-over | Non display |
| M | | | Marking light setting | Display |

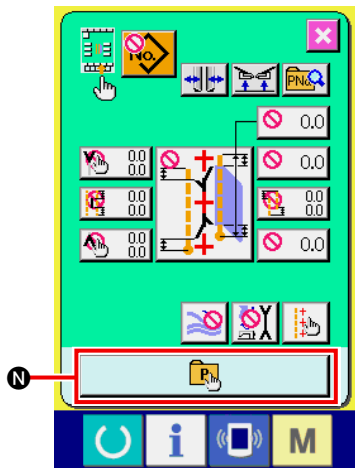

③ **Register the direct pattern.**

When DIRECT PATTERN REGISTER button **N** is pressed, the direct pattern register list screen (screen A) is displayed.

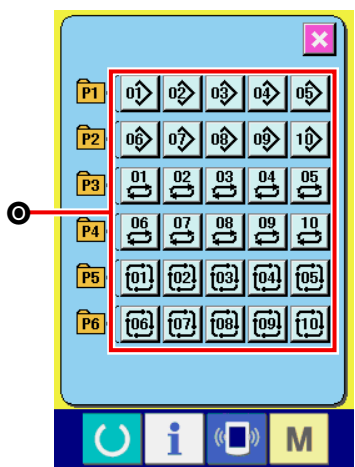

Direct pattern list screen (Screen A)

In the direct pattern list screen, the pattern data of independent sewing/alternate sewing/cycle sewing can be freely registered up to 30.

Register and use the pattern data that are frequently used. Press PATTERN LIST button **O** and the direct pattern selection screen (screen B) is displayed.

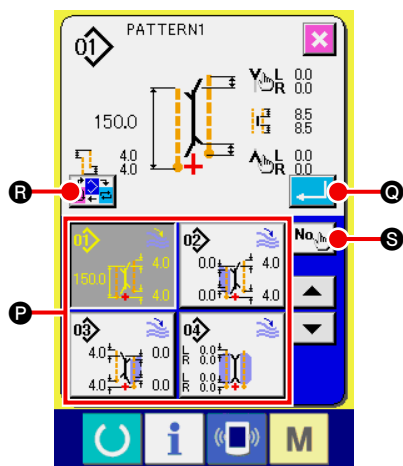

Direct pattern selection screen (Screen B)

Select the pattern you desire to register with PATTERN SELECTION button **P**.

In addition, the ten keys are displayed by pressing NO. INPUT button **S** and the pattern you desire to register can be selected by inputting the ten keys.

 **When the selected button is pressed again, the selection is released.**

When ENTER button **Q** is pressed, register to the direct button is completed and the screen returns to the direct pattern list screen (screen A).

When MODE CHANGEOVER button **R** is pressed, the sewing mode is changed over to independent sewing → alternate sewing → cycle sewing.

 **The direct buttons have not been registered at the time of your purchase.**

15. USING THE INFORMATION

There are three functions below, in the information function.

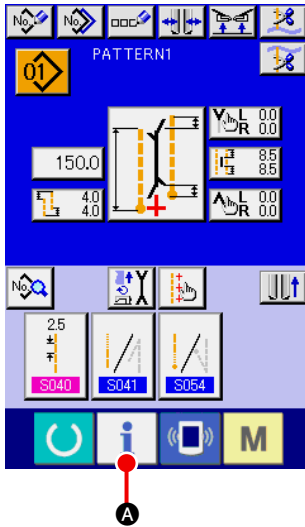

① Display the information screen

Press INFORMATION key  **A** of the switch seat section in the input screen and the information screen (screen A) is displayed.

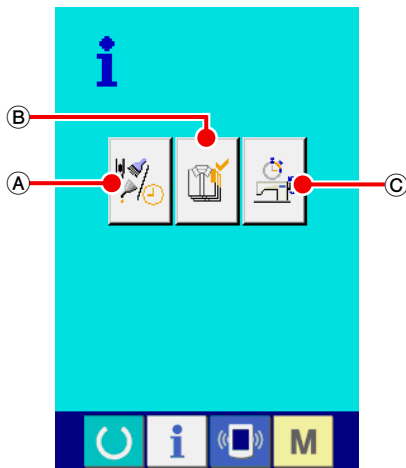

Information screen
(screen A)

Ⓐ Maintenance inspection information

Oil replacement (grease-up) time, needle replacement time, cleaning time, etc. are specified, and when the specified time has passed, the warning notice can be performed.

See “[VI-15-\(1\) Observing the maintenance inspection information](#)” p.85.

Ⓑ Production control information

By means of function to display target production and actual production, the target achieving consciousness of a line or a group is enhanced and also the progress can be confirmed in one glance.

See “[VI-15-\(3\) Observing the production control information](#)” p.87 and “[VI-15-\(4\) Performing setting of the production control information](#)” p.89.

Ⓒ Operation measurement information

Information on machine operating situation, machine operating rate, pitch time, machine time, and machine speed can be displayed.

See “[VI-15-\(5\) Observing the operation measurement information](#)” p.91.

(1) Observing the maintenance inspection information

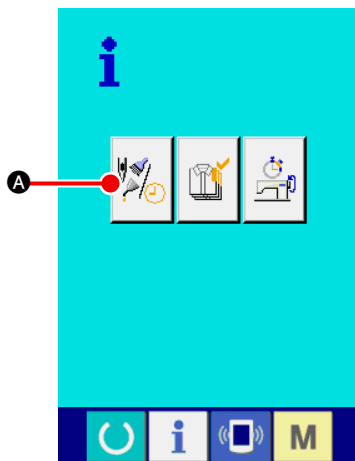

- ① **Display the maintenance information screen**
Press MAINTENANCE INSPECTION INFORMATION SCREEN DISPLAY button  **A** of the information screen.

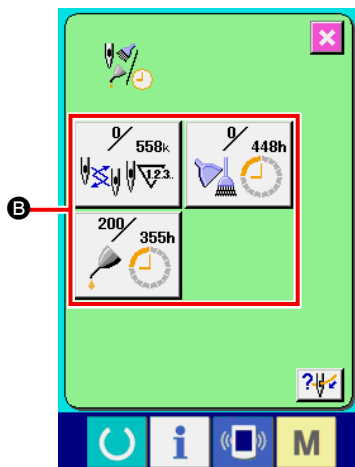

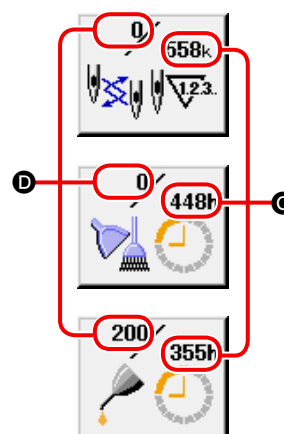

Three items of the information below are displayed in the maintenance inspection information screen.

- Needle replacement (1,000 stitches) :
- Cleaning time (hour) :
- Oil replacement time (hour) :

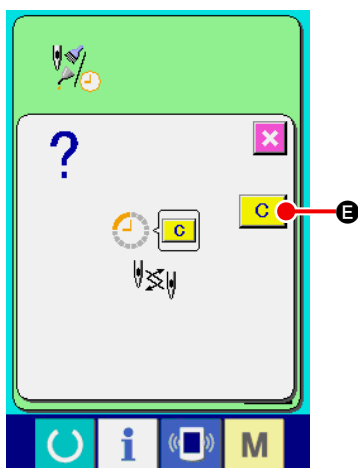

Interval **C** to inform the inspection and remaining time **D** up to replacement are displayed in the respective item buttons **B**. Also, the remaining time up to the replacement can be cleared.



- ② **Perform CLEAR of the remaining time up to the replacement**
Press ITEM button **B** you desire to clear and the replacement time clear screen is displayed.
Press CLEAR button  **E**, and the remaining time up to the replacement is cleared.

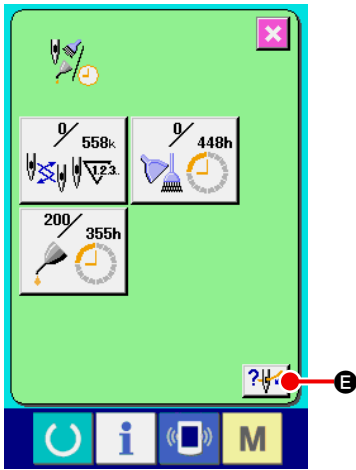

③ Display the threading diagram

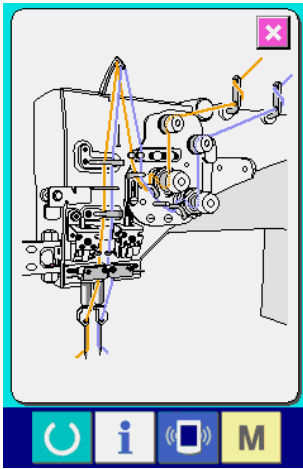

Press THREADING button  **E** displayed in the maintenance inspection information screen and the needle thread threading screen is displayed.

See when performing threading.

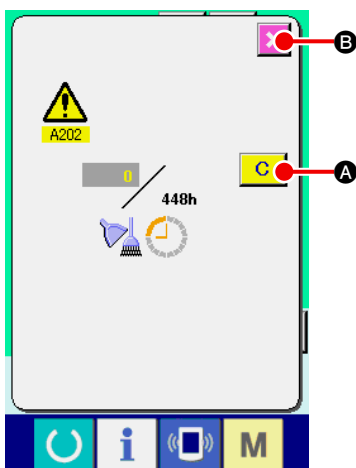

(2) Releasing procedure of the warning



When the specified inspection time is reached, the warning screen is displayed. In case of clearing the inspection time, press CLEAR button  **A**. The inspection time is cleared and the pop-up is closed. If not, press CANCEL button  **B** and close the pop-up. Every time one sewing is completed, the warning screen is displayed until the inspection time is cleared.

Warning Nos. of the respective items are as follows.

- Needle replacement : A201
- Cleaning time : A202
- Oil replacement time : A203

(3) Observing the production control information

It is possible to designate the start, display the number of pieces of production from the start to the existing time, display the number of pieces of production target, etc. in the production control screen. There are two kinds of display ways for the production control screen.

[In case of displaying from the information screen]

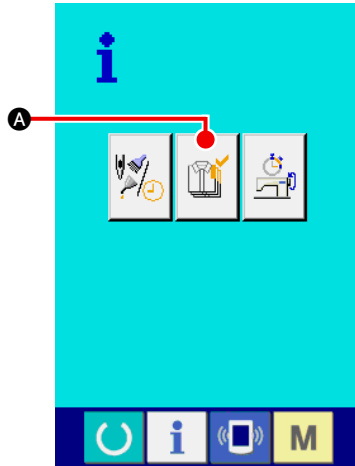

① Display the production control screen

Press PRODUCTION CONTROL SCREEN DISPLAY button



A in the information screen. The production control screen is displayed.

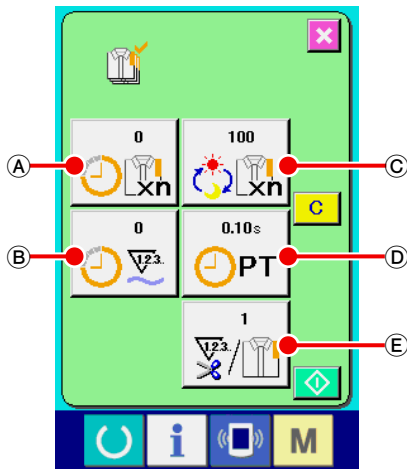

The production control screen is displayed.

- A** : Existing target value
Number of pieces of the target of sewn products at the present time is automatically displayed.
- B** : Actual results value
Number of pieces of the sewn products is automatically displayed.
- C** : Final target value
Number of pieces of the final target of sewn products is displayed.
- D** : Pitch time
Time (second) required for one process is displayed.
- E** : Number of times of thread trimming
Number of times of thread trimming per process is displayed.



Refer to “VI-15-(4) Performing setting of the production control information” p.89, and input **C** number of pieces, **D** time (unit : second) and **E** number of times.

[In case of displaying from the sewing screen]

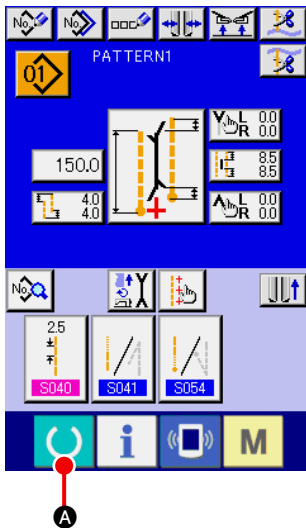

① Display the sewing screen

Press READY key  **A** in the input screen and the sewing screen is displayed.

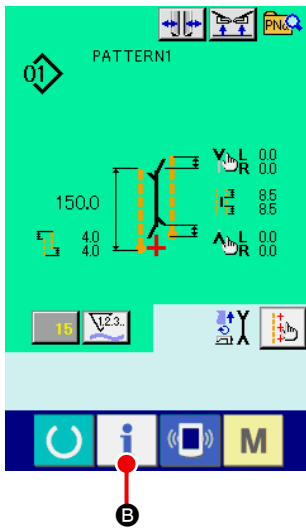

② Display the production control screen

Press INFORMATION key  **B** in the sewing screen and the production control screen is displayed.

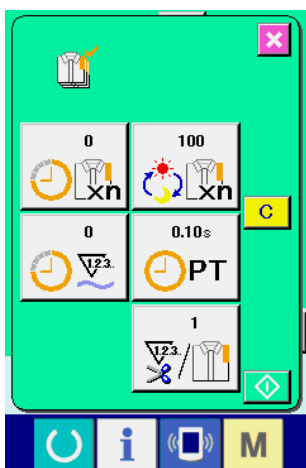

The contents of display and the functions are common to “In case of displaying from the information screen”.

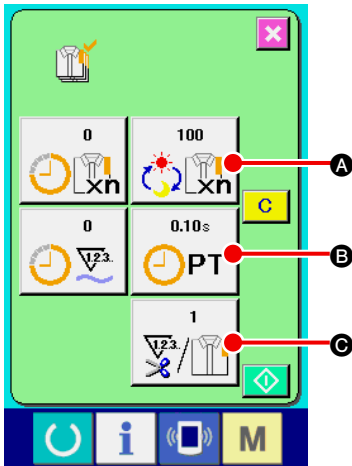

(4) Performing setting of the production control information

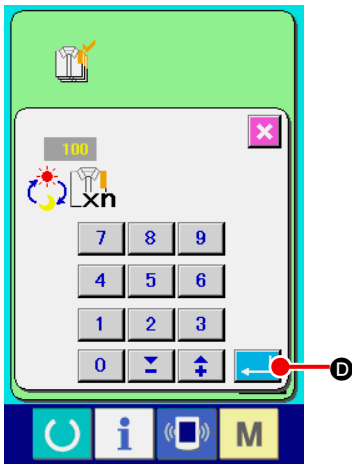

- ① **Display the production control screen**
 Refer to “[VI-15-\(3\) Observing the production control information](#)” p.87 and display the production control screen.





- ② **Input the final target value**
 First, input the number of pieces of the target of production in the process to which sewing is performed from now on.

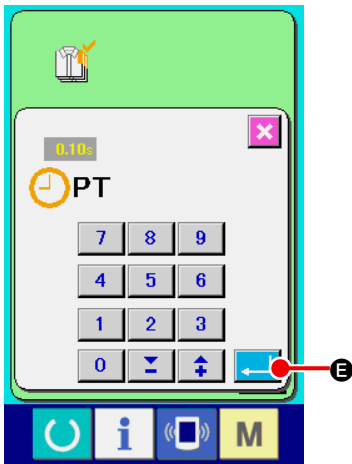

When FINAL TARGET VALUE button  (A) of item ① is pressed, the final target value input screen is displayed. Input the value you desire with ten keys or UP/DOWN buttons. After the input, press ENTER button  (D).

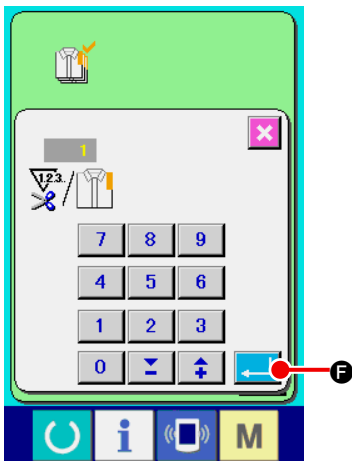

- ③ **Input the pitch time**
 Next, input the pitch time required for one process.

When PITCH TIME button  (B) of item ① is pressed, the pitch time input screen is displayed. Input the value you desire with ten keys or UP/DOWN buttons. After the input, press ENTER button  (E).



- ④ **Input the number of times of thread trimming**
 Next, input the number of times of thread trimming per process. When NUMBER OF TIMES OF THREAD TRIMMING button  (C) of item ① is pressed, the number of times of thread trimming input screen is displayed. Input the value you desire with ten keys or UP/DOWN buttons. After the input, press ENTER button  (F).

* When the input value is “0”, count of the number of times of thread trimming is not performed. Use this function by connecting the external switch.

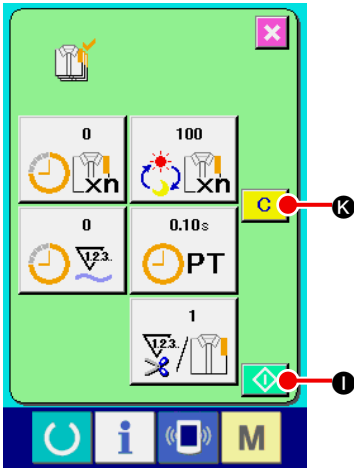



⑤ **Start the count of number of pieces of production**

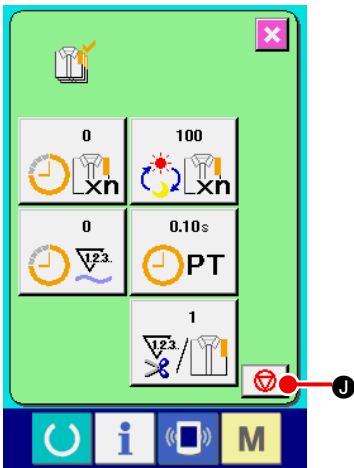

Press START button  ① and the count of number of pieces of production is started.



⑥ **Stop the count**

Display the production control screen referring to “[VI-15-\(3\) Observing the production control information](#)” p.87.

When the count is being performed, STOP button  ② is displayed. When STOP button  ② is pressed, the count is stopped.

After the stop, START button  ① is displayed at the position of STOP button. When continuing the count, press START button  ① again. The counted value is not cleared until CLEAR button  ③ is pressed.

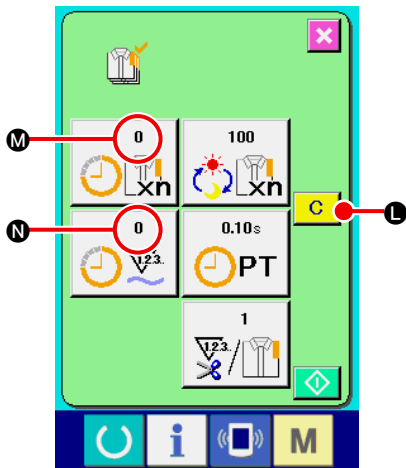



⑦ **Clear the counted value**

When clearing the counted value, set the count to the stop state and press CLEAR button  ④.

The value to be cleared is the present target value **M** and actual results value **N**.

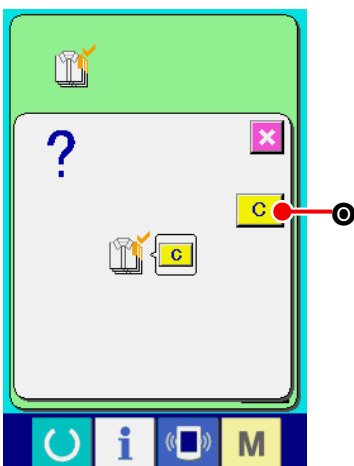
* CLEAR button is displayed only in case of stop state.



When CLEAR button  ④ is pressed, the clear confirmation screen is displayed.

When CLEAR button  ④ is pressed in the clear confirmation screen, the counted value is cleared.

(5) Observing the operation measurement information

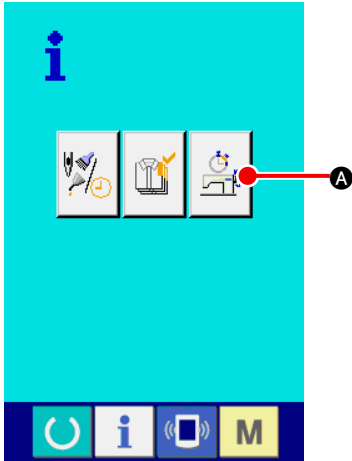

① Display the operation measurement screen

Press OPERATION MEASUREMENT SCREEN DISPLAY button



Press button **A** in the information screen. The operation measurement screen (screen A) is displayed.

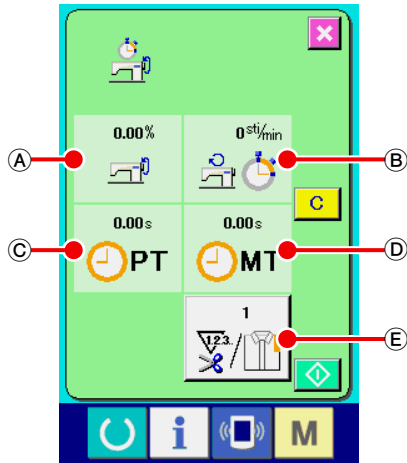

Operation measurement screen
(Screen A)

Information on the following 5 items is displayed in the operation measurement screen.

- Ⓐ : This item automatically displays the operation rate from the time of starting the measurement.
- Ⓑ : This item automatically displays the mean machine speed from the time of starting the measurement.
- Ⓒ : This item automatically displays the mean pitch time from the time of starting the measurement.
- Ⓓ : This item automatically displays the mean machine time from the time of starting the measurement.
- Ⓔ : This item displays the number of times of thread trimming per process.

Input the number of times referring to item ② below.

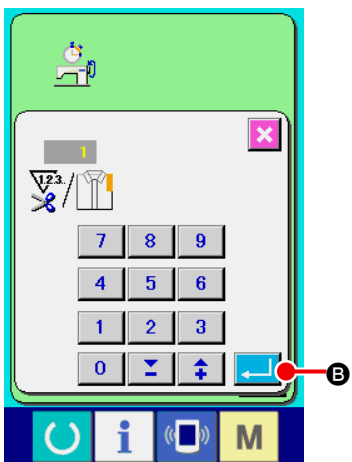

② Input the number of times of thread trimming

Next, input the number of times of thread trimming per process.

Press NUMBER OF TIMES OF THREAD TRIMMING button



Press button **E** and the number of times of thread trimming input screen is displayed.

Input the value you desire with ten keys or UP/DOWN buttons.

After the input, press ENTER button  **B**.

* When the input value is "0", count of the number of times of thread trimming is not performed. Use this function by connecting the external switch.

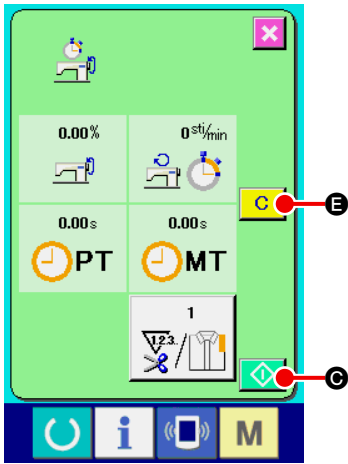



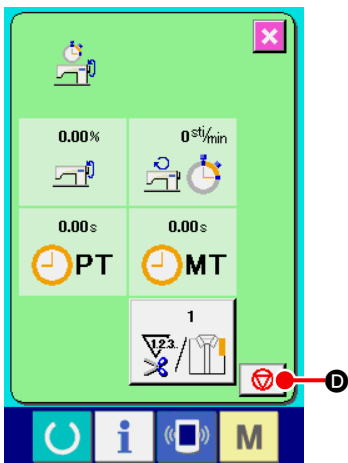

③ **Start the measurement**

Press START button  **C**, and the measurement of each data is started.



④ **Stop the count**

Display the operation measurement screen referring to Items ① and ② of “[VI-15-\(5\) Observing the operation measurement information](#)” p.91.

When the measurement is being performed, STOP button  **D** is displayed. When STOP button  **D** is pressed, the measurement is stopped.  **C** is displayed at the position of STOP button. In case of continuing the measurement, press again START button  **C**. The measured value is not cleared until CLEAR button  **E** is pressed.

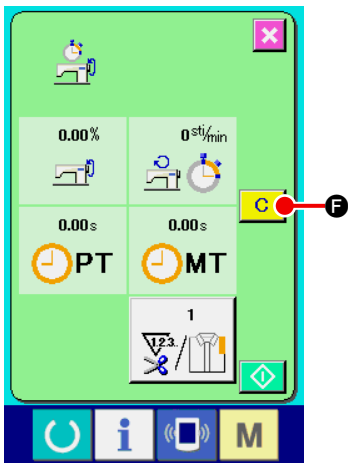



⑤ **Clear the counted value**

When clearing the counted value, set the count to the stop state and press CLEAR button  **F**.

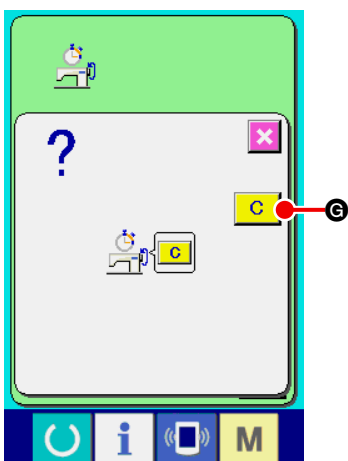
* CLEAR button is displayed only in case of stop state.



When CLEAR button  **F** is pressed, the clear confirmation screen is displayed.

When CLEAR button  **G** is pressed in the clear confirmation screen, the counted value is cleared.

16. USING THE COMMUNICATION FUNCTION

Communication function can download the sewing data created with other sewing machine . In addition, the function can upload the aforementioned data to the media or personal computer.

As the means of communication, a media slot and USB are prepared.

(1) Handling possible data

xxx : File No.

| Data name | | Extension | Description of data |
|-------------|---|--------------|---|
| Sewing data |  | APW xxx .EPD | Sewing data created by the sewing machine exclusive for APW |

(2) Performing communication by using the media

For handling way of the media, read "[VI-1. PREFACE](#)" p.21.

(3) Performing communication by using USB

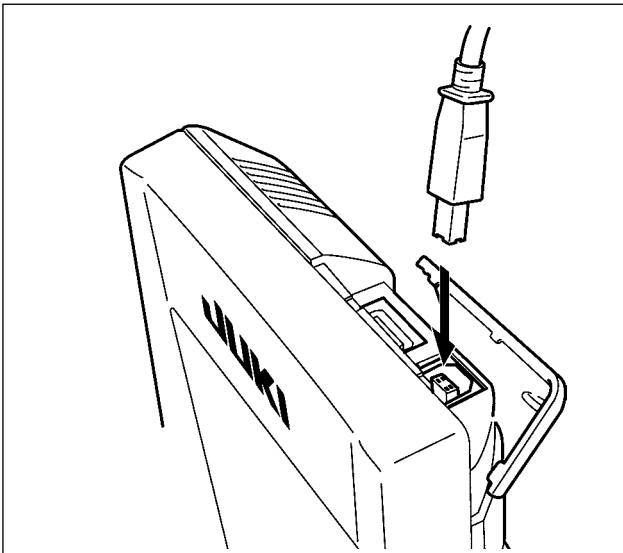

Data can be sent/received to/from a personal computer or the like, by means of a USB cable.



If the contact part becomes dirty, failure of contact will be caused. Do not touch by hand, and control so that dust, oil or other foreign material does not adhere to it. In addition, the inside element is damaged by static electricity or the like. So, be very careful when handling.

(4) Take-in of the data

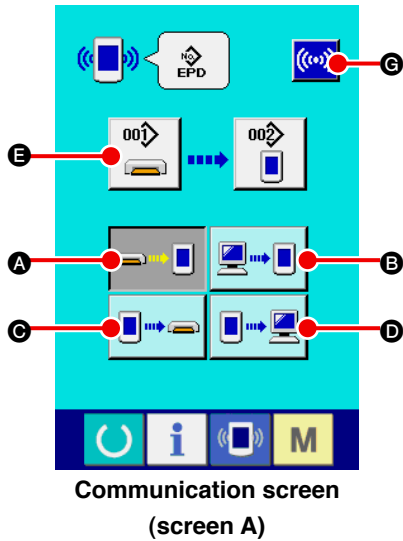

① Display the communication screen

When COMMUNICATION key  of switch seat section is pressed in the input screen, the communication screen (screen A) is displayed.

② Select the communication procedure

There are four communication procedures as described below.

- A** Writing data from media to panel
- B** Writing data from personal computer (server) to panel
- C** Writing data from panel to media
- D** Writing data from panel to personal computer (server)

Select the button of communication procedure you desire.

③ Select the data No.

When  **E** is pressed, the writing file selection screen is displayed.

Input the file No. of the data you desire to write. For the file No., input APWxxx. of the file name and the numerals of the part xxx of EPD. Designation of the pattern No. of writing destination can be performed in the same way. When the writing destination is the panel, pattern Nos. which have not been registered are displayed.

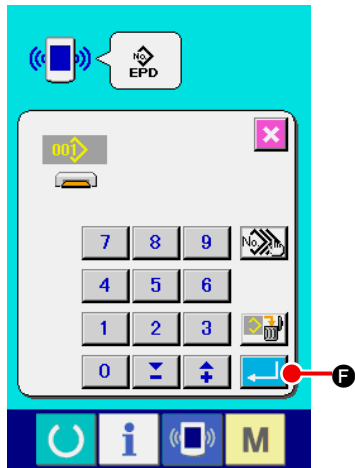

④ Determine the data No.

When ENTER button  **F** is pressed, the data No. selection screen is closed and the screen returns to the communication screen (screen A).

⑤ Start communication

When COMMUNICATION START button  **G** is pressed, the data communication starts.

The during communication is displayed during communication and the screen returns to the communication screen after the end of communication.



Do not open the cover during reading the data. Data may not be read in.

(5) Take-in of plural data together

It is possible for the sewing data to select plural data to be written and write all together. Pattern No. of writing destination is the same No. of the selected data No.



No.99 and after of the media cannot perform the plural selection.



① Display the writing file selection screen

Press PLURAL SELECTION button  **A** and the data No. plural selection screen is displayed.

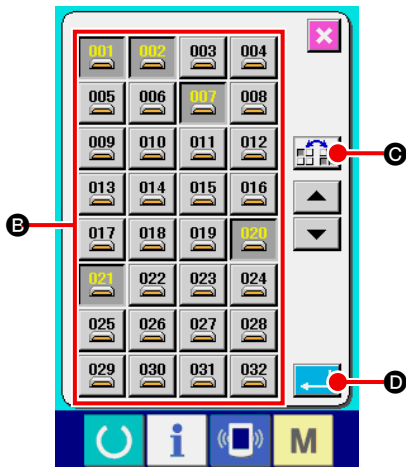

② Perform the selection of data No.

List of the file No. of the existing data is displayed. Press FILE No. buttons **B** you desire to write. It is possible to reverse the selection state of the button with REVERSE button  **C**.

③ Determine the data No.

When ENTER button  **D** is pressed, the data No. plural selection screen is closed and the selection of data ends.

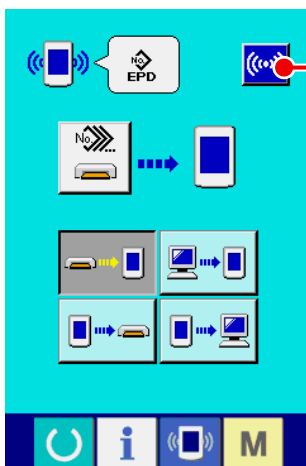

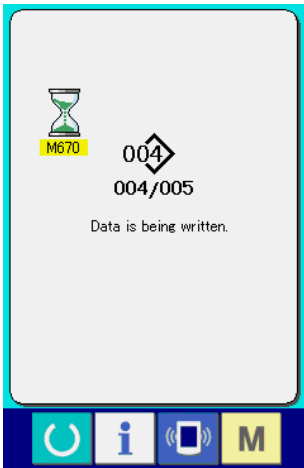

④ Start the communication

Press COMMUNICATION START button  **E** and the data communication starts.

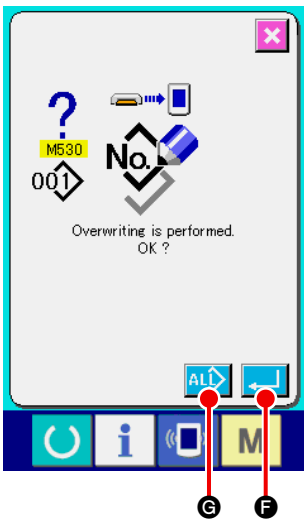

Data No. during communication, total number of writing data and number of data that have finished the data communication are displayed in the during communication screen.



- * When performing writing to the pattern No. that already exists, the overwriting confirmation screen is displayed before writing. When performing overwriting, press ENTER button  **F**. When performing overwriting to all without displaying the overwriting confirmation screen, press OVERWRITING button  **G** in all cases.

17. PERFORMING FORMATTING OF THE MEDIA

When re-formatting the media, be sure to perform it with IP-420. The media that have been formatted with the personal computer cannot be read with IP-420.

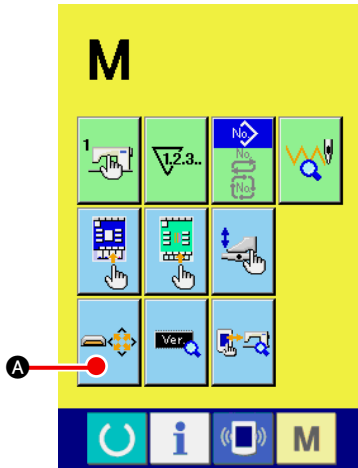

① Display the media format screen

Keep pressing MODE CHANGEOVER key **M** for three seconds and MEDIA FORMAT button  **A** is displayed on the screen. When this button is pressed, the media format screen is displayed.

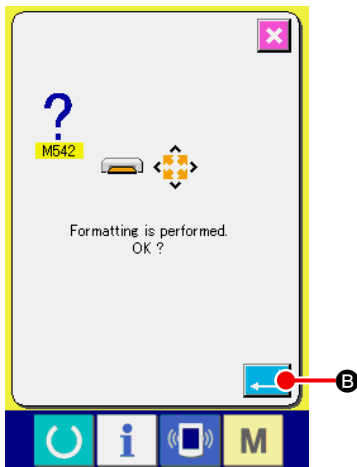

② Start formatting of the media

Set the media you desire to format to the media slot, press ENTER button  **B** after closing the cover and formatting starts.

Store the necessary data in the media to other media before formatting. When formatting is performed, the inside data are erased.

VII. MAINTENANCE

1. INSPECTION

Be sure to periodically execute the maintenance and inspection to keep the performance of this machine.

Be sure to periodically execute the work since machine trouble may be caused unless the maintenance and inspection are performed.

(1) Maintenance and inspection of the pneumatic device



CAUTION :

To prevent accidents caused by abrupt start of the sewing machine, do not place hand(s), foot, face or tools on the machine moving part.

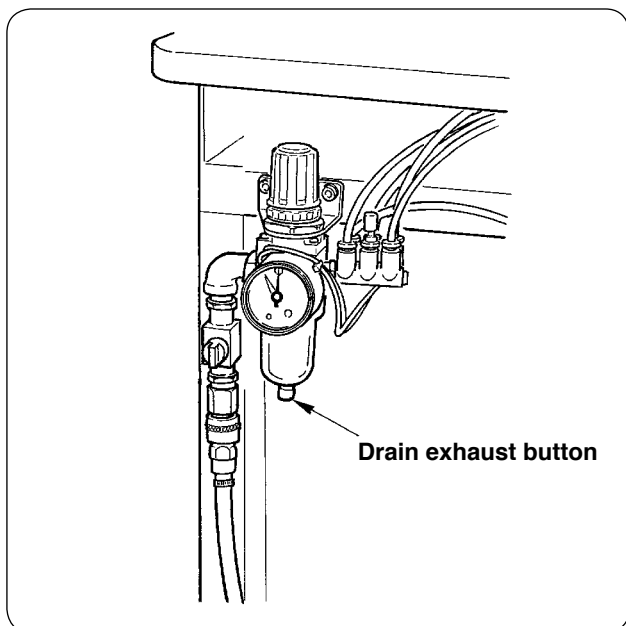

- Discharge the drain of filter every day.
Press the drain exhaust button located at the bottom of filter to exhaust the drain.

(2) Maintenance and inspection related to the sewing machine



CAUTION :

To prevent accidents caused by abrupt start of the sewing machine, start the work after turning OFF the power.

- When dust adheres to the small places of the machine such as clamp foot or the like, normal operation is disturbed. Be sure to perform cleaning before the work. In addition, be sure to clean the thread waste in the hook cover once a week.
- Check the sharpness of center knife and corner knife before the work, and try to replace it in good time.
- For the lubrication of the sewing machine, be sure to use the designated oil JUKI MACHINE OIL No. 1 (MDFRX1600C0).
- Periodically replace the thread guide felt. (Refer to "[V-1-\(3\) How to pass the needle thread](#)" p.14).

(3) With regard to the waste oil of the hook oil



CAUTION :

To prevent accidents caused by abrupt start of the sewing machine, start the work after turning OFF the power.

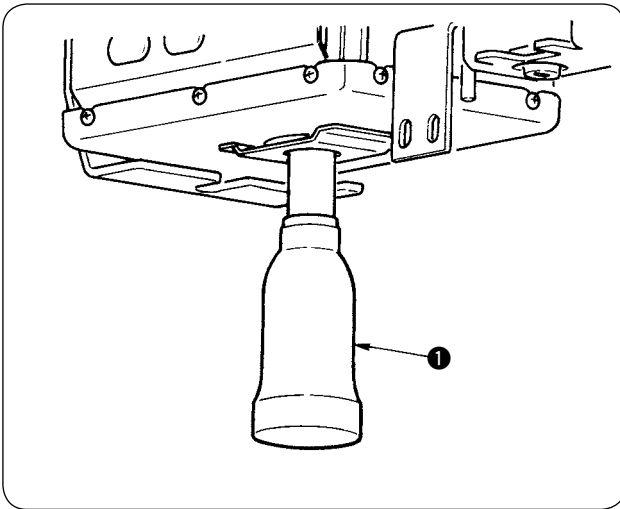

Turn and remove the oil can, and drain the waste oil when the waste oil gathered in approximately half of oil can ① located on the machine bed cover.

(4) With regard to the cleaning of the hook shaft base



CAUTION :

To prevent accidents caused by abrupt start of the sewing machine, start the work after turning OFF the power.

Periodically clean the waste cloth or the like gathered in the hook oil cover.

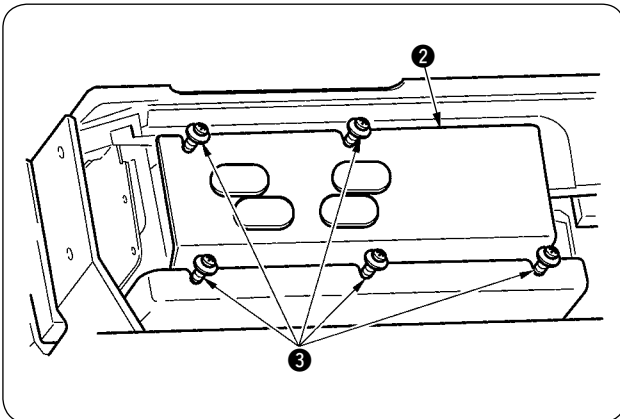

- Raise the machine head and remove oil cover ② after loosening setscrews ③ (5 places).

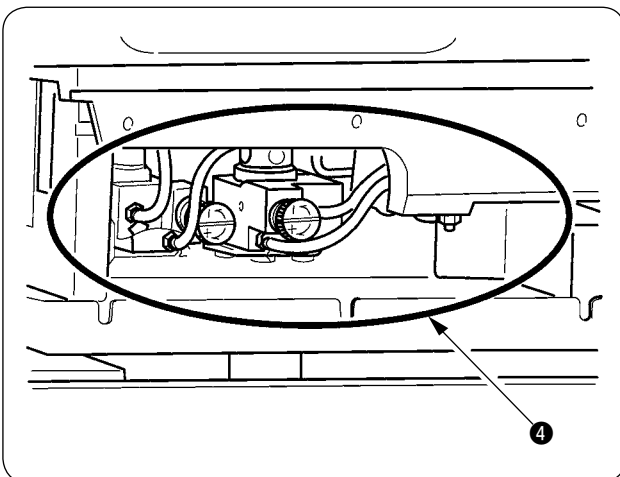

- Clean the inside of hook oil cover ④.

2. MARKING LIGHT



WARNING :

1. If the laser light directly enters the eye, eyesight trouble may be caused.
Do not look into the laser inlet/outlet.
2. Never perform installing/removing of the marking lamp with the power turning ON.
In addition, do not use the light other than marking.

(1) Marking light for sewing reference setting

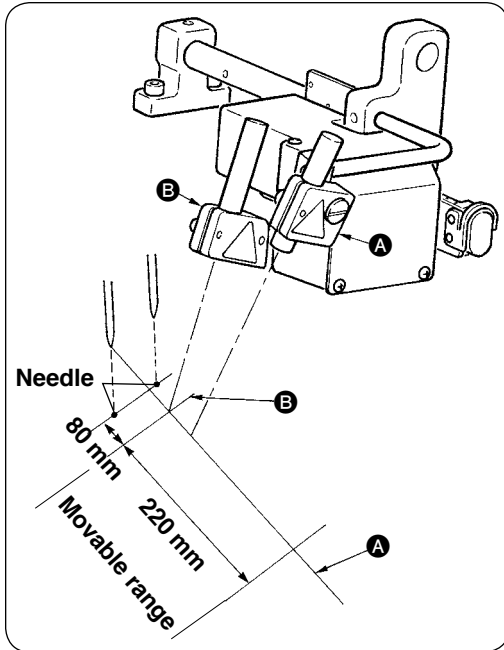

The light of marking light on the front side observed from the operator side is used for longitudinal line reference setting (fixed) **A** and that in the rear side is used for lateral line reference setting (moving according to the sewing type) **B**.

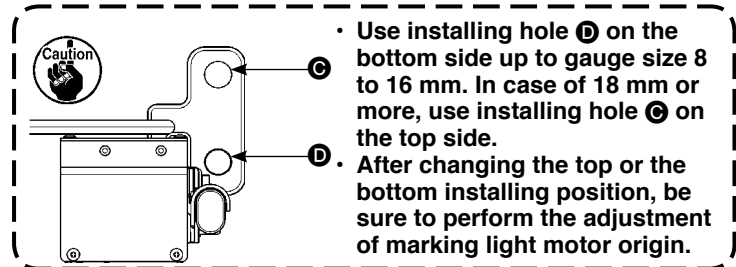

| Laser specifications | |
|------------------------------|-----------------------------------|
| Lateral line reference laser | Longitudinal line reference laser |
| Class 2 laser product | Class 2M laser product |
| Maximum output: 1.0mW | Maximum output: 3.5mW |
| Wave length: 650nm | Wave length: 650nm |
| Safety standard | |
| JIS C 6802:2011 | |
| IEC60825-1+A2:2007 | |

(2) Adjusting the marking light irradiation position

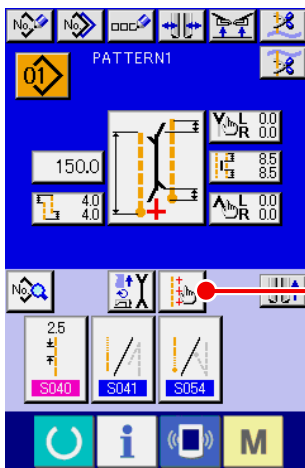

Press button **A** in the input screen and the marking light setting screen is displayed. Then the irradiation position of marking light can be adjusted.

Lateral line irradiation position of marking light is determined by the sewing type, and the irradiation position is automatically moved by **B** "S005 change-over of sewing start irradiation/sewing end irradiation/center irradiation" and "S004 L size setting".

When the compensation value of **C** is 0.0 mm, the marking light irradiates the sewing position.

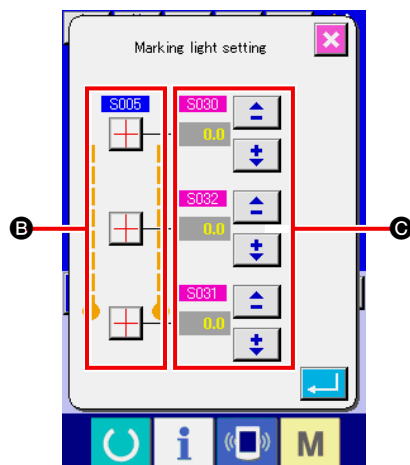





When you desire to move the marking light irradiation position in terms of the sewing position, set each compensation value of **C** for use.

- S030** : Sewing start irradiation position compensation
- S031** : Sewing end irradiation position compensation
- S032** : Center irradiation position compensation

3. REPLENISHING GREASE TO THE DESIGNATED PLACE

- * When “Grease-up warning E220” or “Grease-up error E221” is displayed, or when the machine has been used for one year, be sure to perform replenishing of grease.

When turning ON the power after the sewing machine has operated up to 40 million stitches, “grease-up warning E220” informing of the time of grease replenishment is displayed on the panel. When pressing RESET button  to leave the error screen, the machine can continue operating. However, the error has not been released and the error is displayed every time the power is turned ON. After performing replenishment of grease which is explained later, call “Memory switch U245” and set the number of stitches of operation to “0” with CLEAR button .

When the machine has been continuously used up to 48 million stitches, “grease-up error E221” is displayed on the panel. In this case, even when RESET button  is pressed and the error screen is released, the sewing after that cannot be performed. Be sure to call “Memory switch U245” and set the number of stitches of to “0” with CLEAR button  after performing replenishment of grease which is explained later.



1. “Grease-up warning E220” and “Grease-up error E221” are displayed again unless memory switch U245 is cleared to “0” after replenishing grease.
2. Be sure to use the grease tube (Part No. : 40006323) supplied with the machine as accessories for replenishing grease to the designated place which is explained later. If any grease other than the designated one is replenished, Component breakage will be caused.
3. Keep the used grease tube in a safe place.



CAUTION :

To prevent accidents caused by abrupt start of the sewing machine, start the work after turning OFF the power.

(1) Grease-up procedure

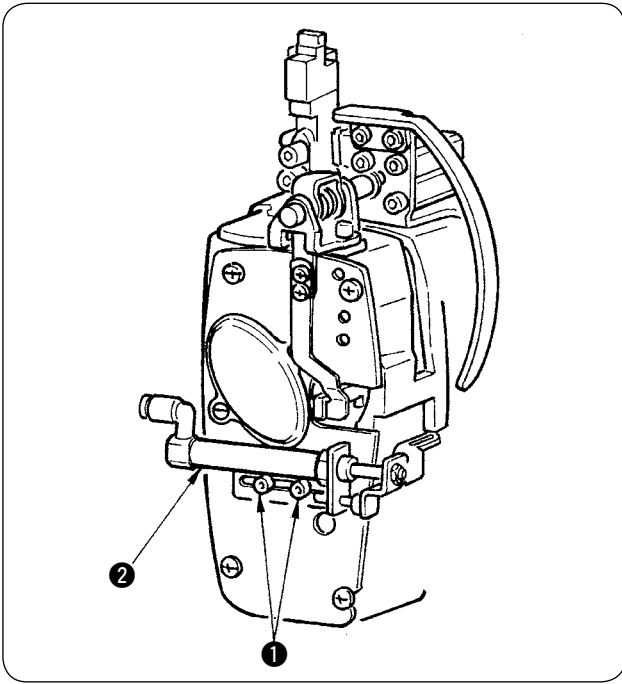

- ① Loosen two screws ① (SM6040602TP) and move wiper cylinder ② to the right side.

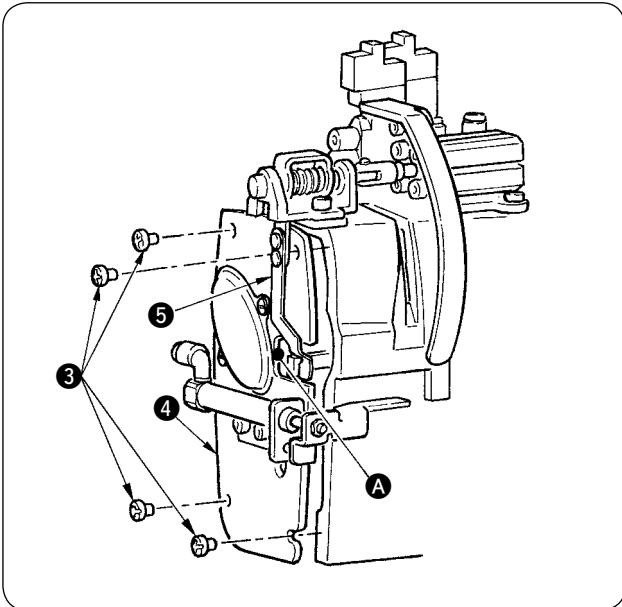

- ② Loosen two screws ③ (SM4050655SP) and move face plate cover ④ to the left side. At this time, be careful of moving the cover along escape A of the cover so that it does not come in contact with plate spring ⑤.

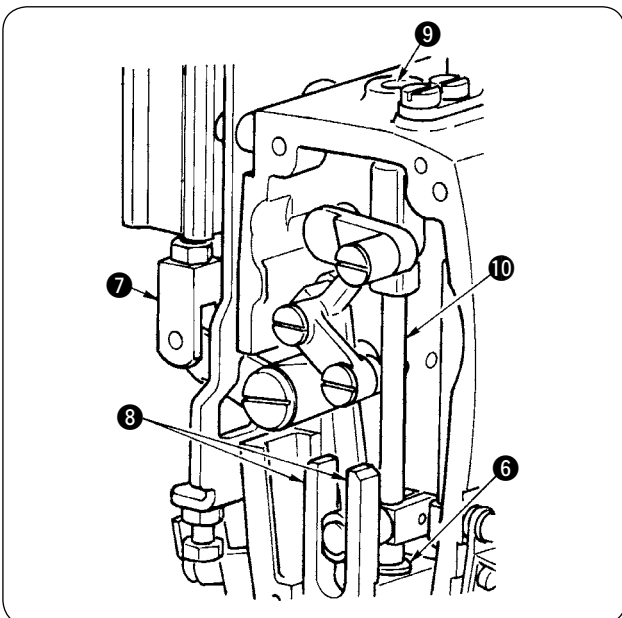

- ③ Replenishment of grease to the center knife section
- Apply grease to both planes of guides ⑧, knife bar metal, upper ⑨, and knife bar metal, lower ⑥.
 - Knife bar ⑩ moves up and down by moving cylinder joint ⑦ up and down in the state that air is not supplied. Apply grease to the metal so as to infiltrate the inside.

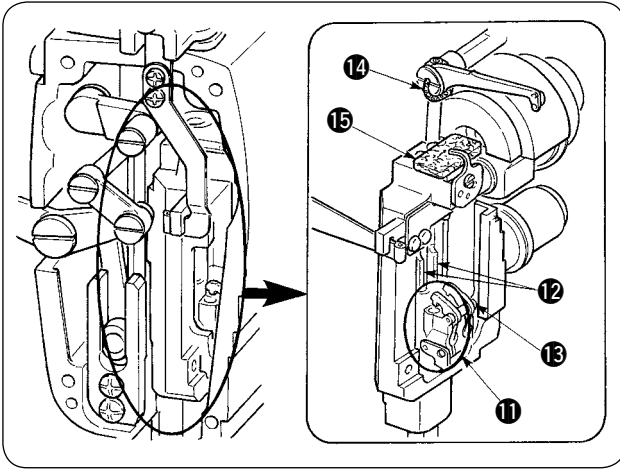

- ④ Replenishment of grease to the needle bar section
Apply grease to thread take-up lever 14, felt 15, needle bar bracket 11, needle bar 12 and square block 13.
- ⑤ After applying grease in the face plate, install the face plate cover by reversing the removing procedure.

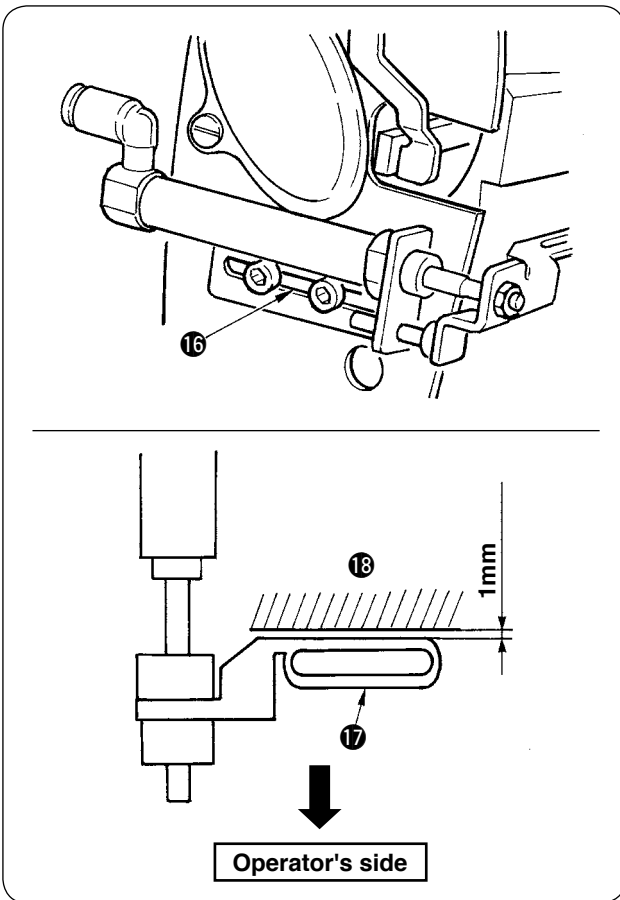

- ⑥ Fix the screws to be symmetrical to the center of slot 16 so as to keep the clearance (approximately 1 mm) between wiper 17 and arm 18 open.

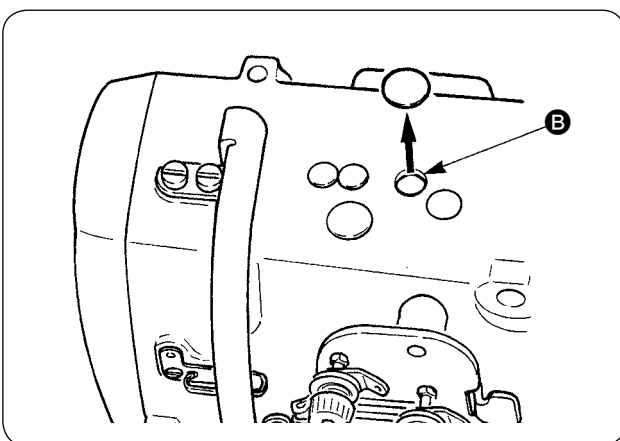

- ④ Remove the rubber cap and apply new grease to the inside of the hole after removing old grease adhered to the inside of hole B. Then cover the hole with the rubber cap.

4. CONSUMABLE REPLACEMENT COMPONENTS

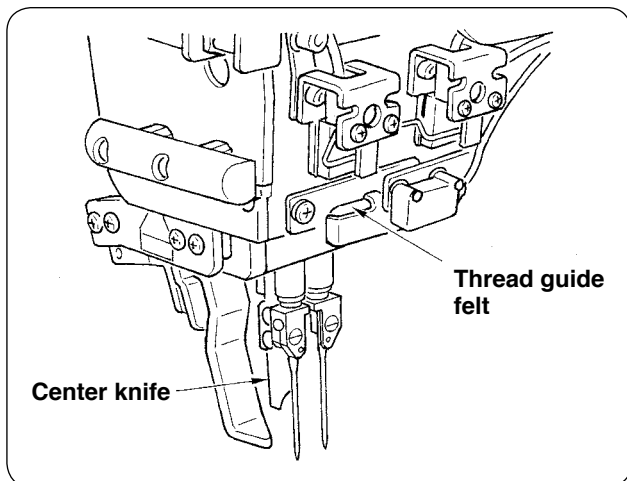

The components below are the consumable ones. Periodically replace them.

- **Thread guide felt (Part No. : 40034444)**
The part where thread passes is worn out and rough motion of thread is apt to occur unless it is periodically replaced.

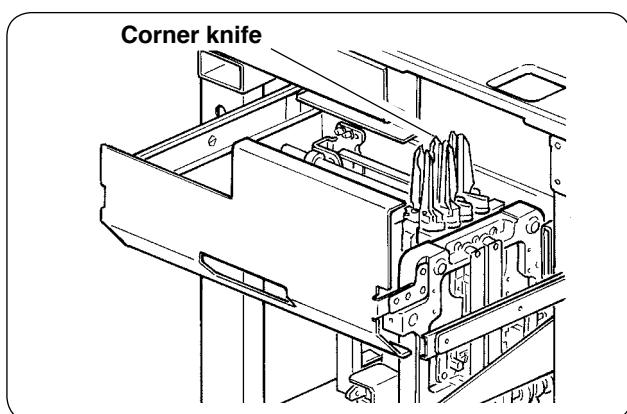

- **Center knife (Part No. : 40026155)**
- **Corner knife A (Part Nos. : 16607301 and 16607400)**
- **Corner knife B (Part Nos. : 16607509 and 16607608)**
- **Corner knife C (Part Nos. : 16607707 and 16607806)**

Sharpness is deteriorated and sewing quality is influenced unless it is periodically replaced.

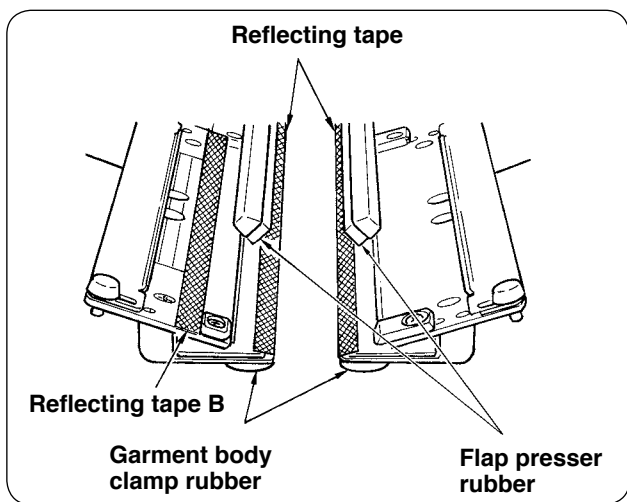

- **Reflecting tape (Part No. : 40039942)**
 - **Reflecting tape B (Part No. : 40064403)**
- Accuracy of detection of flap is deteriorated and sewing quality is influenced unless it is periodically replaced.

- **Garment body clamp rubber (Part No. : 40034825)**
 - **Flap presser rubber (Part No. : 40034826)**
- Pressing of material is deteriorated and sewing quality is influenced unless it is periodically replaced.

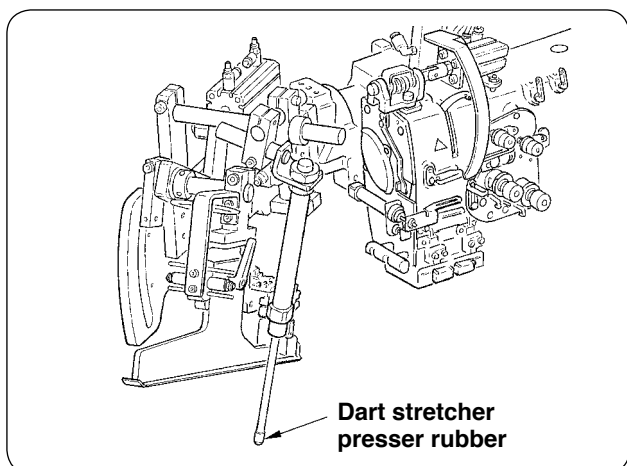

- **Dart stretcher presser rubber (Part No. : 40034733)**
- Pressing of material is deteriorated and sewing quality is influenced unless it is periodically replaced.

5. TILTING THE MACHINE

CAUTION :



- Turn OFF the power before starting the work so as to prevent accidents caused by abrupt start of the sewing machine.
- When tilting/raising the machine, be careful not to allow your hands, fingers or any other part of your body to be caught in the related parts.

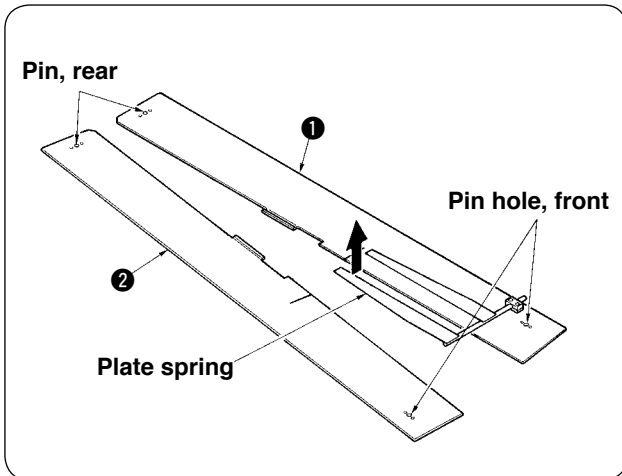

- ① Remove sewing tables ① and ②.

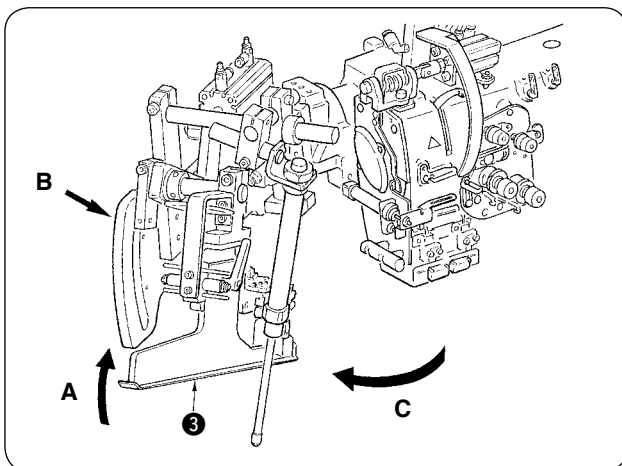

- ② Turn the binder unit.
Lift binder ③ in the direction A, support section B by hand and turn the whole binder in the direction C.



Binder is locked with ball plunger. Turn it rather strongly in the direction of C to release the lock.

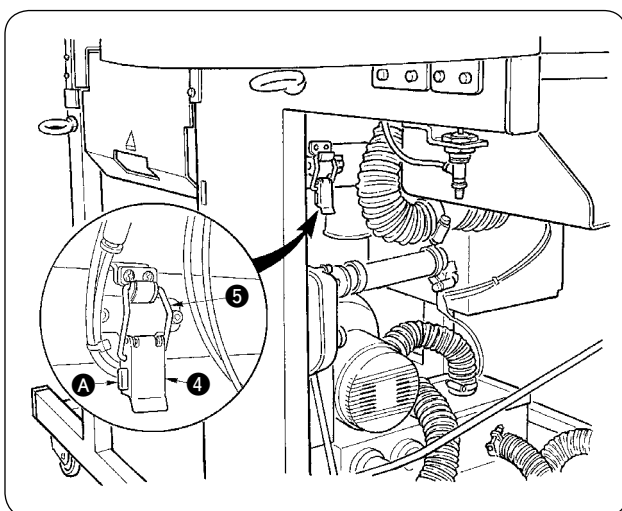

- ③ Release machine fixing hinge.
Pressing section A, release machine fixing hinge ④, and remove hinge hook ⑤.

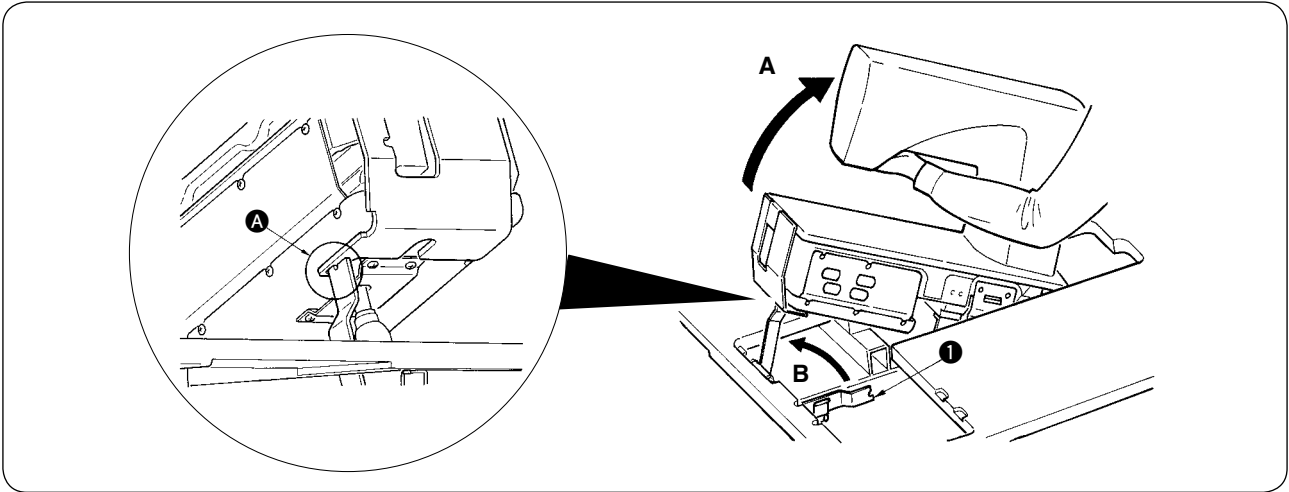

CAUTION :



1. For turning the sewing machine head, be sure to perform with two persons or more.
2. To avoid personal injuries, when returning the machine head from the raised state to the home position, return it to the home position after confirming that there is no tool or component under the gas spring.
3. To avoid personal injuries and damage of sewing machine, do not damage with tools or parts the rod section of the gas spring located under the machine head.
4. To avoid personal injuries, immediately replace the gas spring with a new one when the rod section of gas spring does not function properly with a flaw or the like, or it is judged as a defective one. [Do not use anything other than JUKI genuine gas spring (Part No. : 40023177).]
5. To avoid personal injuries, do not use with the gas spring removed.

④ Turn the sewing machine.

- Hold the bottom side of the machine arm and lift the whole sewing machine in the direction A.
- Lift the sewing machine fixing plate ① in the direction B, put the point of the sewing machine fixing plate ① to the hole of the machine bed, and fix the sewing machine. (Refer to ②.)

⑤ When returning the sewing machine, set the sewing machine by reversing the procedure.

6. STANDARD OF REPLACING TIME OF THE GAS SPRING

CAUTION :



- Turn OFF the power before starting the work so as to prevent accidents caused by abrupt start of the sewing machine.
- When tilting/raising the machine, be careful not to allow your hands, fingers or any other part of your body to be caught in the related parts.

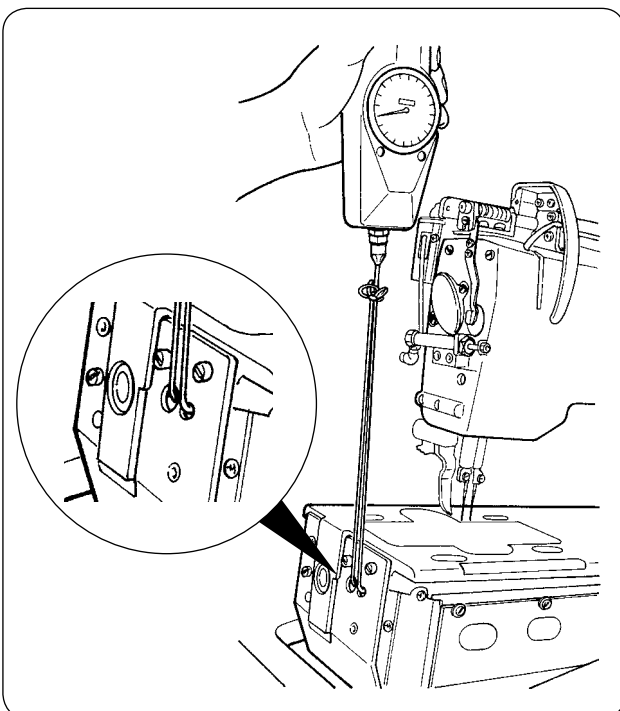

- 1) Gas spring is one of the consumables. Gas inside the gas spring will be gone naturally even when the frequency of use is low and the spring cannot display the thrust to secure the safety. In case a force of 130N or more is necessary when passing strings through the front end of machine bed and lifting the sewing machine as shown in the left-hand figure, quickly replace the spring with JUKI genuine gas spring (Part No. : 40023177).



Gas spring is a component that can be used with ease. However, there is a flaw on the rod section or a section that is weak in the side load when the gas spring is fully stretched. Be very careful when performing maintenance or cleaning of the sewing machine.

7. REPLACING PROCEDURE BETWEEN DOUBLE-WELT AND SINGLE-WELT



CAUTION :

To prevent accidents caused by abrupt start of the sewing machine, start the work after turning OFF the power.

(1) Replacing procedure between double-welt and single-welt

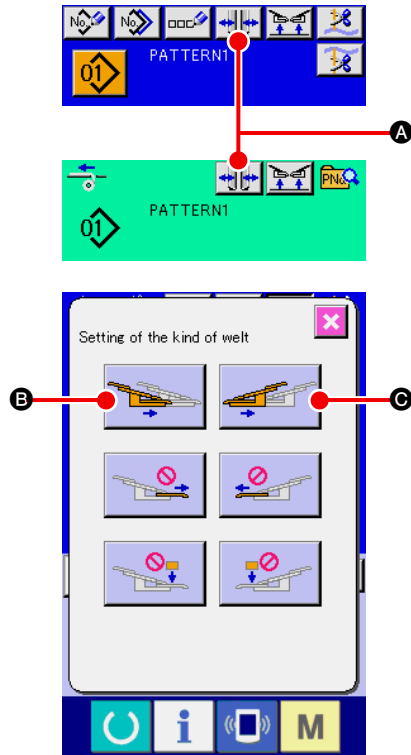

① Turn ON the power and advance the clamp foot.

② Press button  **A** to display the type of welt setting screen.

③ When button **B** is pressed, the left garment body clamp operates between inside and outside alternately. When button **C** is pressed, the right garment body clamp operates between inside and outside alternately.

Select the position of left and right garment body clamps in accordance with the sewing type.

In addition, press buttons **B** and **C** to operate the garment body clamp between inside and outside at the time of fine adjustment of the position of garment body clamps which is explained later.

(2) Fine adjustment of the position of garment body clamp

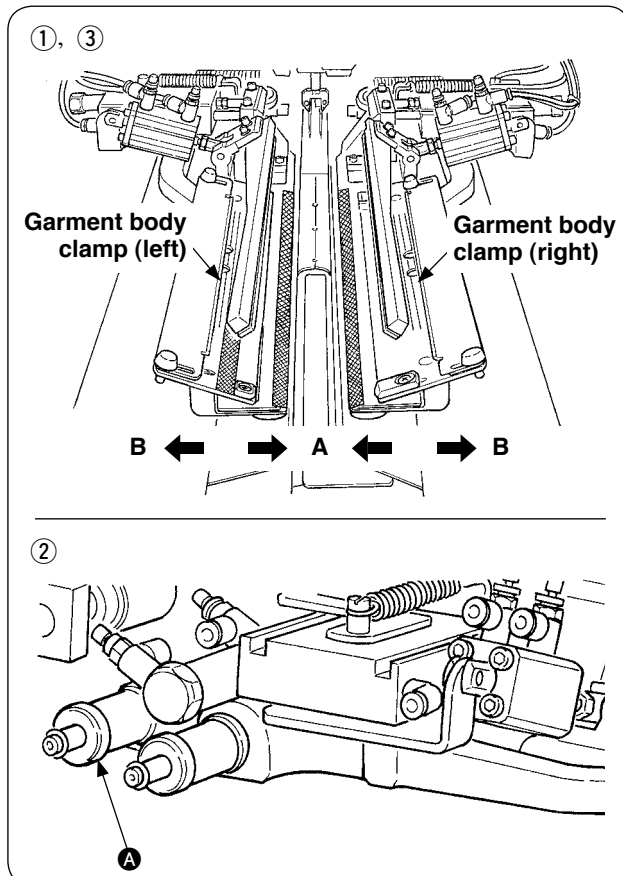

• Fine adjustment of double-welt type

① Move the position of garment body clamp to outside (direction B) on the panel.

② It is possible to perform the fine adjustment of the position of garment body with adjustment knob for double-welt **A**.

Move it clockwise to outside (direction B) and counterclockwise to inside (direction A).

③ Move the position of garment body clamp to inside (direction A) on the panel and confirm the position.

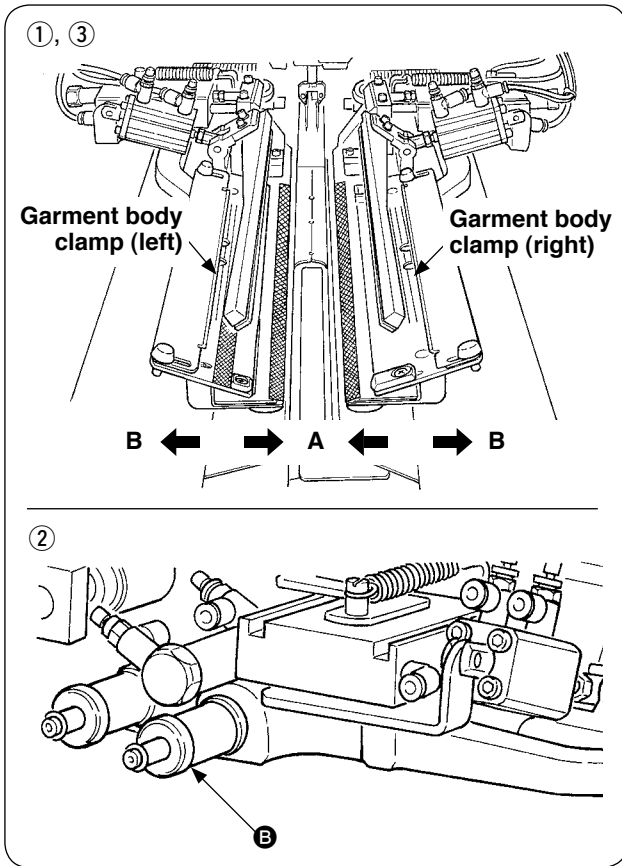

- Fine adjustment of single-welt type
- ① Move the position of garment body clamp to inside (direction A) on the panel.
 - ② It is possible to perform the fine adjustment of the position with adjustment knob for single-welt **B**. Move it clockwise to inside (direction A) and counterclockwise to outside.
 - ③ Move the position of garment body clamp to outside (direction B) on the panel and confirm the position.

(3) Replacing the binder

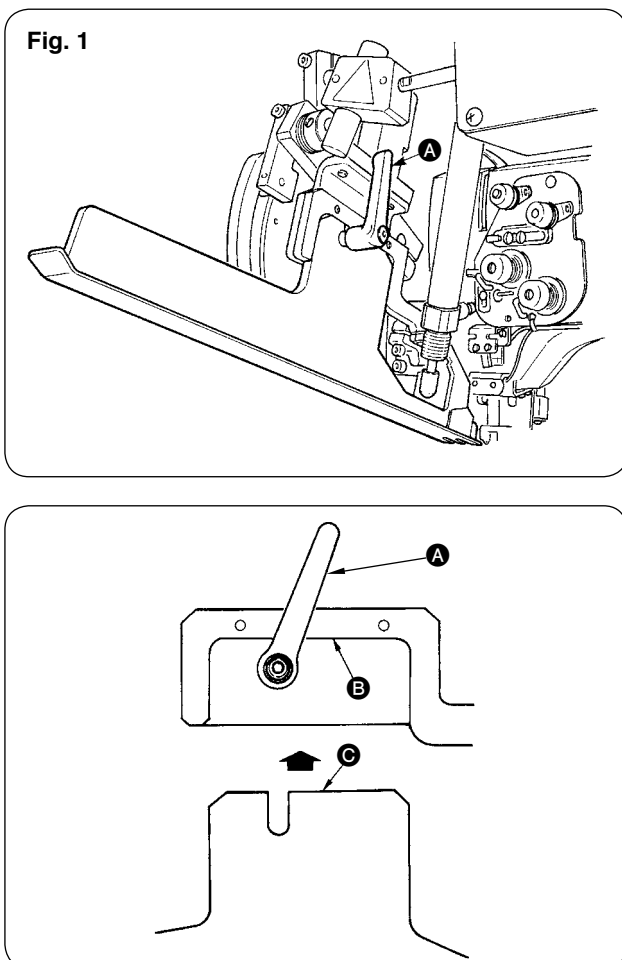

- ① Turn lever **A** counterclockwise with the binder lifted as shown in Fig. 1, and remove welting patch scale for double-welt (single-welt) (asm.).
- ② Set welting patch scale for double-welt (single-welt) (asm.) and fix it with lever **A**.



When fixing the welting patch scale for double-welt (single-welt) (asm.), perform fixing in the state that plane **B** comes in contact with plane **C**.

8. CORNER KNIFE

CAUTION :



1. Turn OFF the power before starting the work so as to prevent accidents caused by abrupt start of the sewing machine.
2. Do not touch your fingers or hands to the blade section of knife. so as to prevent fatal accidents.
3. Perform the adjustment work by the maintenance engineers who are familiar with the sewing machine and trained for the safety so as to prevent accidents caused by unfamiliarity or wrong adjustment.

(1) Corner knife unit

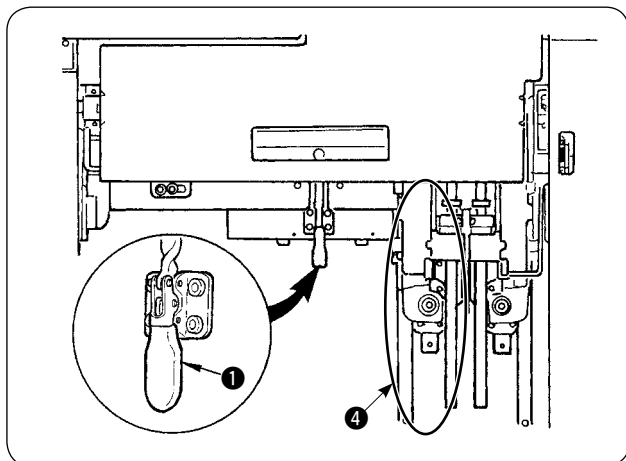

- ① Release toggle clamp ①.



Adjusting angle of the corner knife of this model has been factory-adjusted to approximately 50° for the parallel sewing (one side 25° each) or approximately 43° (25° and 18°) for deflection amount of 4 mm or more at the time of delivery.

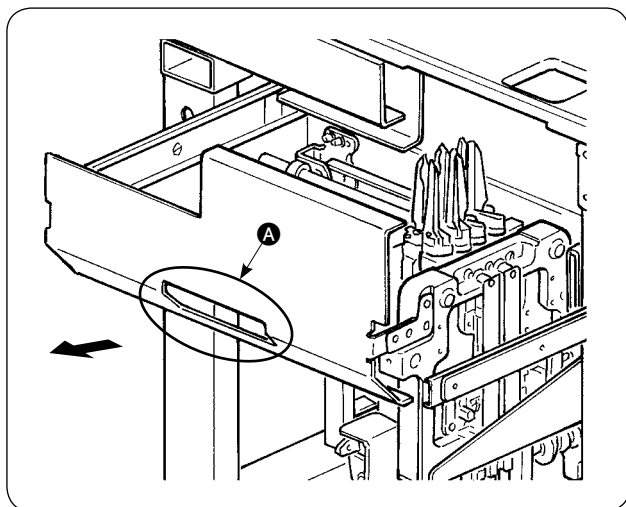
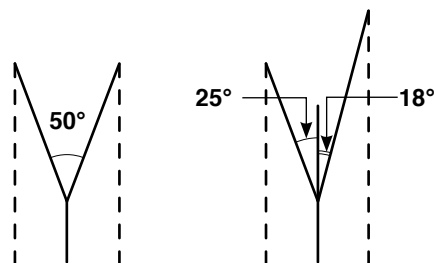

- ② Hold section A and draw out the drawer in the direction of the arrow.



Draw it out. until it goes no further.

- ③ After the adjustment, return the drawer to its home position and fix it with toggle clamp ①.



When returning the drawer, return corner knife on the moving side ④ to the initial position.

(2) Adjusting the corner knife



CAUTION :

Be careful not to slip your hand since the adjustment work is performed with a screwdriver.

Fig.1

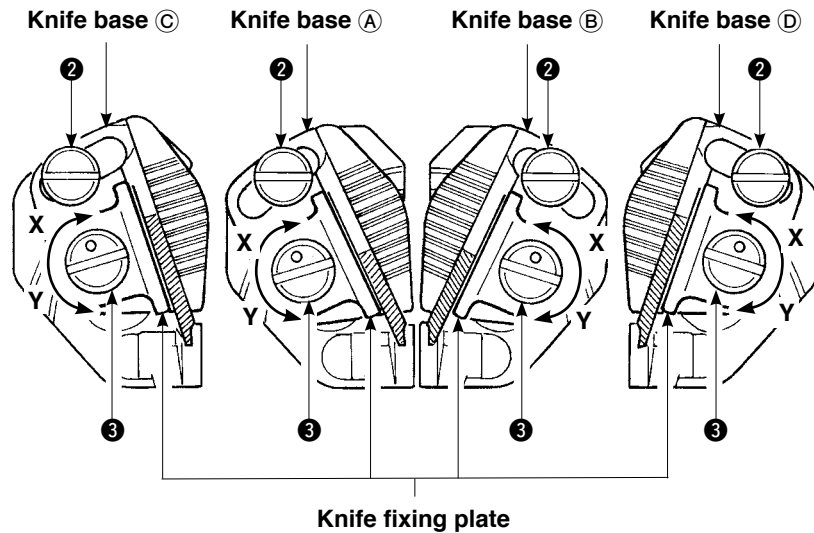

[Adjusting the open angle of knife]

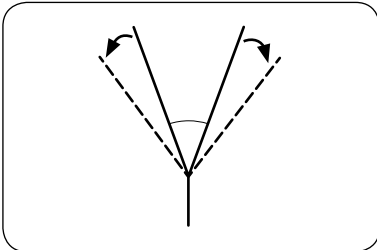

- 1) Loosen angle adjustment screws ②, adjust knife bases ① and ②, ③, ④ and fix the screws.



Direction of rotation to loosen left/right knives is different from each other.

[Adjusting the cutting length of knife]

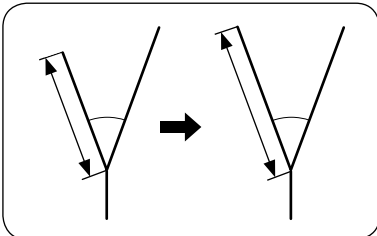

- 1) Turn eccentric pin ③ in the direction of the arrow mark Y with a flat-blade screwdriver or the like and loosen the knife.
- 2) Tilt the knife and adjust the cutting length.
- 3) Turn eccentric pin ③ in the direction of the arrow mark X with a flat-blade screwdriver or the like and fix the knife.

[Adjusting place]

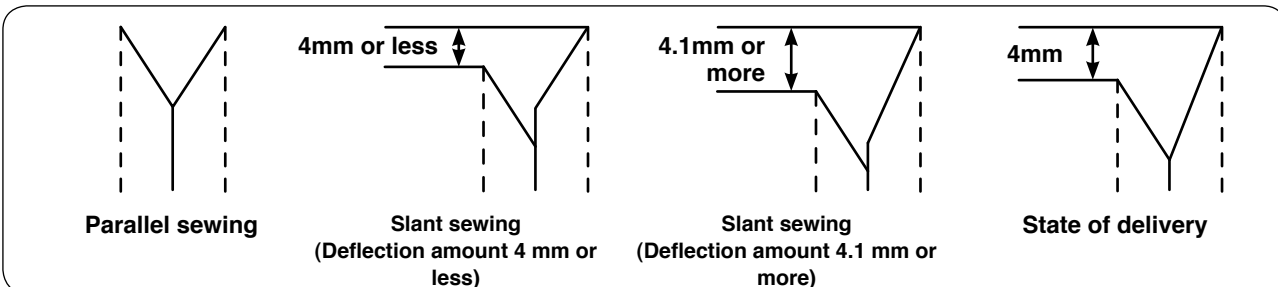

- 1) Adjusting place of the knife at the time of parallel sewing and slant deflection amount 4 mm or less
Adjust the knife of the center (knife base ① or ②) of Fig. 1.
* Adjust the knife with the parallel sewing.
- 2) Adjusting place of the knife at the time of deflection amount 4.1 mm or more
For the adjustment of knife that seams appear on the outside, perform the adjustment of outside (knife base ③ or ④) of Fig. 1.
For the adjustment of knife that seams enter on the inside, perform the adjustment of center (knife base ① or ②) of Fig. 1.
* The difference of length in the longitudinal direction between the center knife and the outside knife is 4 mm in the state of delivery.

(3) Corner knife adjustment function screen

This mode is the mode to adjust the installation of the corner knife.



For the actual adjustment procedure of the knife, refer to "(2) Adjusting the corner knife" of "Instruction Manual (this manual) for APW-896", p.110.

In the state of the delivery from the factory, the corner knives have been adjusted to ± 0.5 mm longitudinally and 0.0 mm laterally at the setting of size L = 150 mm using a piece of the trial sewing cloth attached to the sewing machine.

Use the machine after adjusting the knives in accordance with your sewing products.

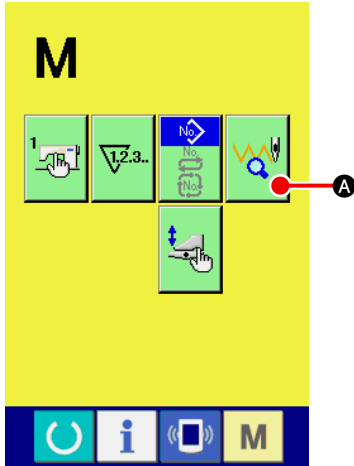

① **Display the pattern selection screen for corner knife adjustment**

Press MODE CHANGEOVER key **M** to display the pattern

selection screen for corner knife adjustment and press PATTERN

SELECTION button  **A** for corner knife adjustment that is

displayed on the screen.

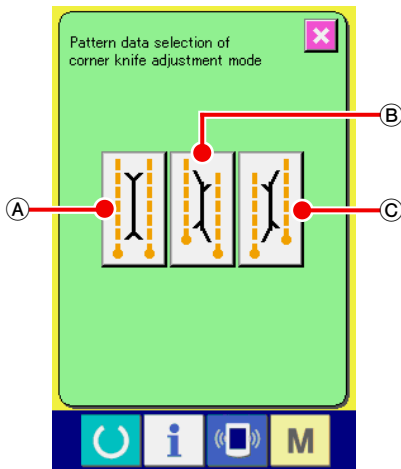

Three adjustment patterns below are displayed in the pattern selection screen for corner knife adjustment.

Ⓐ Corner knife - Parallel

Ⓑ Corner knife - Left deflection

Ⓒ Corner knife - Right deflection

Pattern selection screen for corner knife adjustment

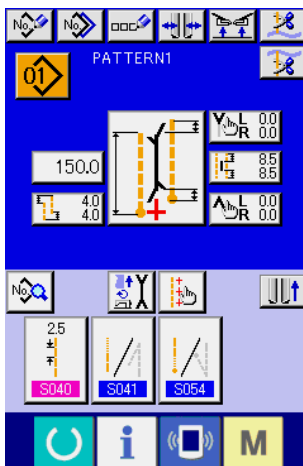

When MODE CHANGEOVER key **M** is pressed, the input screen is displayed.

Input screen

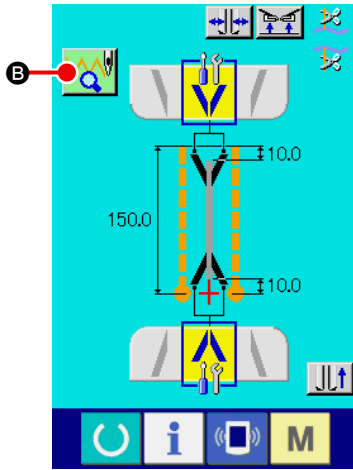

Corner knife adjustment sewing screen
(A)

② **Display the corner knife adjustment sewing screen.**

When pressing the pattern button you desire to adjust, the corner knife adjustment sewing screen (A) is displayed.

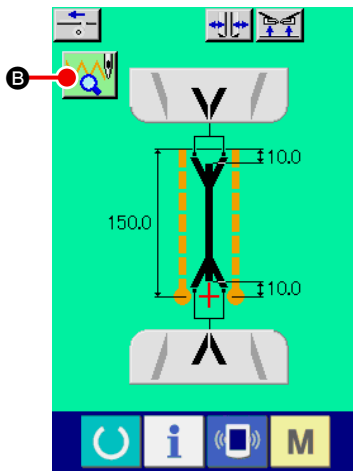

Corner knife adjustment sewing screen
(B)

When READY key  is pressed, the corner knife adjustment sewing screen (B) is displayed.

Press PATTERN SELECTION button  **B** for corner knife adjustment and the screen returns to the pattern selection screen for corner knife adjustment.

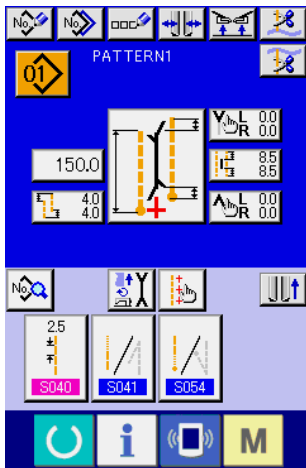

Input screen

When MODE CHANGEOVER key  **M** is pressed, the input screen is displayed.



When performing the adjustment of corner knife using this mode at the time of replacement of corner knife, be sure to confirm again the compensation value of each data of the corner knife.

(4) Corner knife actuating position setting procedure

By pressing corner knife actuating position setting button (A) or (B), it is possible to set the corner knife actuating position.

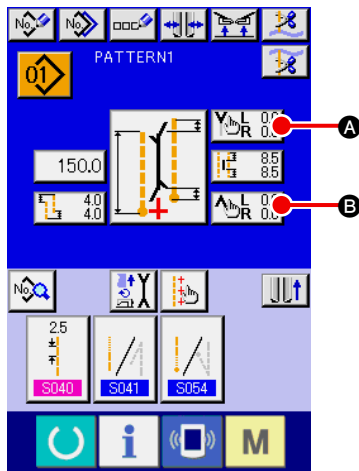

Independent sewing mode
/ cycle sewing mode

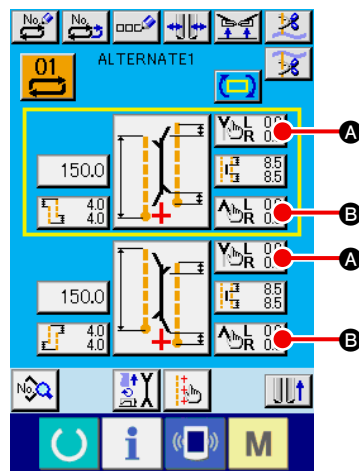

Alternate sewing mode

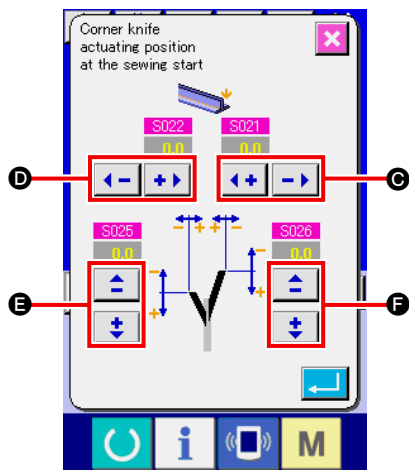

Corner knife actuating position at the
start of sewing setting screen
(Screen A)

① Setting of corner knife actuating position at the start of sewing

For the setting of corner knife actuating position at the start of sewing, there are 4 kinds of right width (C), left width (D), left side front and rear (E) and right side front and rear (F), and it is possible to separately set.

It is possible to set by pressing + button and “-“ button respectively.

See S021 , S022 , S025 and S026 of "VI-8. (2) Sewing data list" p.51.

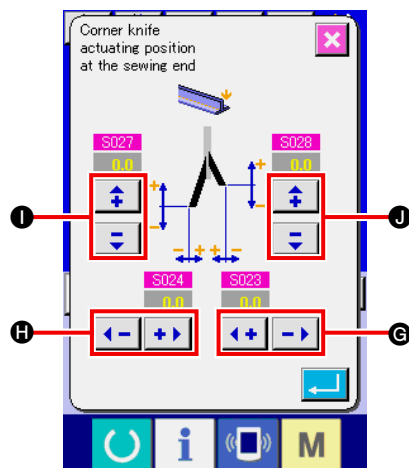

Corner knife actuating position at the
end of sewing setting screen (Screen B)

② Setting of corner knife actuating position at the end of sewing

For the setting of corner knife actuating position at the end of sewing, there are 4 kinds of right width (G), left width (H), left side front and rear (I) and right side front and rear (J), and it is possible to separately set.

It is possible to set by pressing + button and “-“ button respectively.

See S023 , S023 , S027 and S028 of "VI-8. (2) Sewing data list" p.51.

(5) Feature of the corner knife actuating position setting

Corner knife of APW-896 has the features below.

- Left and right corner knives are independent and the corner knife actuating positions of left and right corner knives can be separately adjusted.
- Two kinds of long and short corner knives are provided to comply with the slant sewing of large deflection amount.

Corner knife when performing slant sewing shows the cutting edge as shown in Fig. 1.

In the state of parallel sewing that the relation of position of left and right knives (deflection of knife) is “0”, left and right knives simultaneously push up. However, when there is deflection between the knives, left or right knife separately goes up and comes down, and the material is cut.

[Deflection of corner knife]

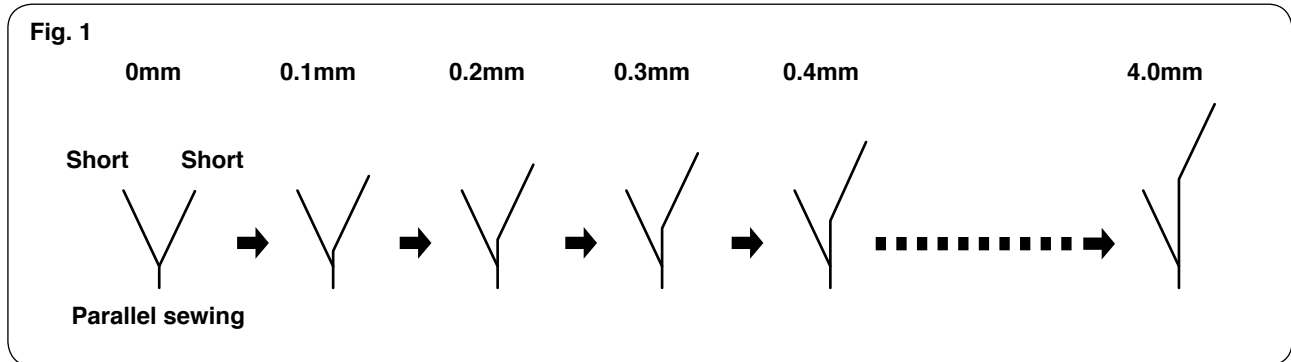

As shown in Fig. 2, the deflection of knife exceeds 4.0 mm, the knife on the outside does not cut.

Thereby, cutting is performed by combination of a short knife and a long knife.

(Refer to I) of “Caution” below.)

[Deflection of corner knife]

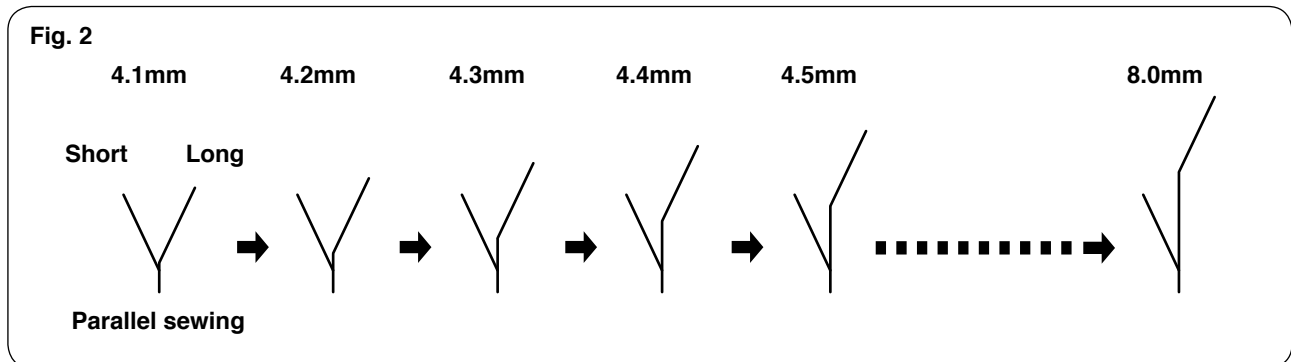

There are two conditions that the corner knife does not cut normally.

- I) When the offset amount of left and right knives exceeds 4.0 mm (4.1 mm or more) (Fig. A)
- II) When the long knife enters the inside of the short knife (Fig. B)

Fig. A

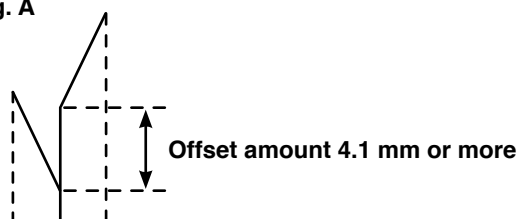
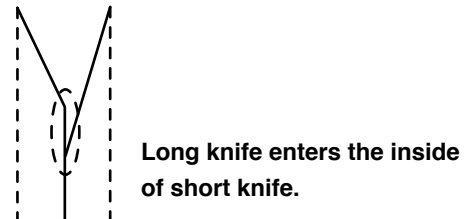

Fig. B



In case of any condition described above, the corner knife does not cut, and error message (E480/E481) of “Setting that corner knife does not cut” is displayed on the panel.



In the standard state of delivery, the deflection of corner knife can be used only up to 8.0 mm.

When desiring to perform the deflection setting of more than 8.0 mm, change the setting of deflection following the procedure next. The following is an example of deflection setting of 10.0 mm.

- 1) Adjust the long corner knife so that the cutting length of the outside knife becomes from 4.0 mm to 6.0 mm. For the actual adjustment procedure of the knife, refer to "(2) Adjusting the corner knife" of "Instruction Manual (this manual) for APW-896", p.110.
- 2) After the adjustment of the knife, it is necessary to change the setting of excess cut length according to the adjustment amount of corner knife since the initial values of the excess cut length of index (M002 / M003) are 4.0 mm respectively
Add 2.0 mm to the excess cut length and set the initial value 4.0 mm to 6.0 mm since the knife has been adjusted so that the cutting length of the long corner knife becomes longer by 2.0 mm.

(Caution) When the setting exceeds 8.0 mm, the range that the corner knife cannot cut comes out. The range is 4.1 mm to 5.9 mm as shown in (Fig. C). This range corresponds to conditions I) and II) and error message (E480/E481) of "Setting that corner knife does not cut" is displayed on the panel as well. Please understand.

Fig. C

Relation of positions of left/right corner knives (Deflection setting of 10.0 mm is taken as an example.)

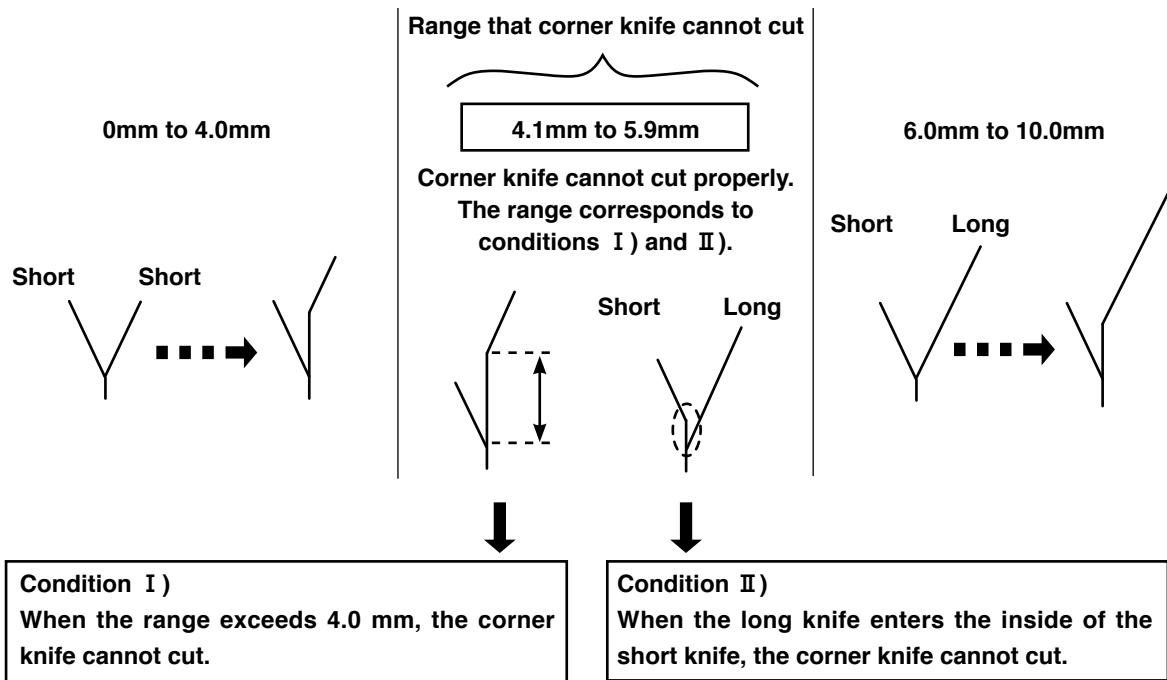

(Caution) When the sewing type is changed, be sure to use the machine after confirming the positions of corner knife and center knife with trial sewing.

(6) Deflection amount setting

1. Automatic deflection detection function

By pressing the button of automatic deflection detection function, the flap is read using two flap sensors and the deflection can be automatically set.

However, when **SA134** Right flap angle detection device is not mounted, left flap (double welt and single welt with one side flap) only can be used.

- ① When the input screen of independent sewing mode, alternate sewing mode or cycle sewing mode, DEFLECTION AMOUNT SETTING button **A** is displayed.
When this button is pressed, "DEFLECTION AMOUNT SETTING SCREEN (SCREEN A)" is displayed.

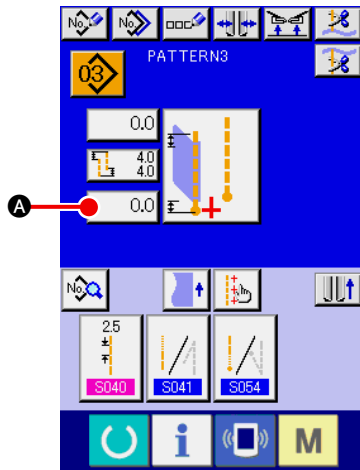

Independent sewing mode
/ cycle sewing mode

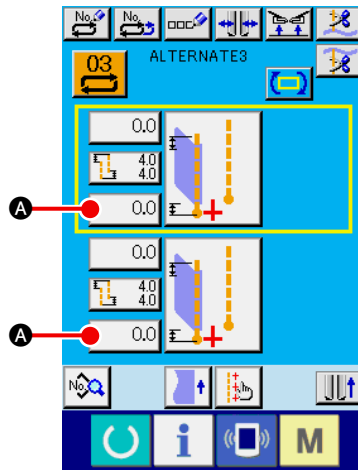

Alternate sewing mode

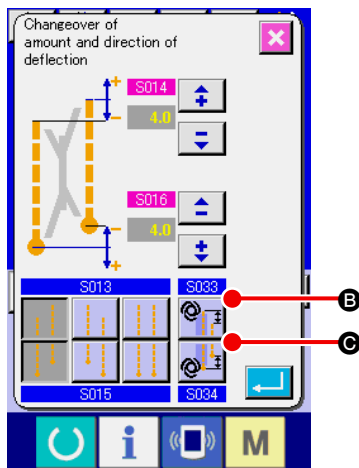

② Setting of automatic deflection detection function

When using the automatic deflection detection function, it is possible to set by pressing **AUTOMATIC DEFLECTION DETECTION AT THE START OF SEWING** button **B** or **AUTOMATIC DEFLECTION DETECTION AT THE END OF SEWING** button **C**.

Only when setting the left flap sewing, it is effective to press down the button.



In case of the flap of deflection of 2 mm or less, select the deflection manual input mode since the automatic deflection reading mode may judge the flap as the parallel flap.



When setting this function or setting the changeover of compensation of flap concealed stitching position using the deflection detection of **L026**, the flap concealed stitching position is automatically set.

(Refer to **S035** and **S036** of "VI-8. (2) Sewing data list" p.51

9. CENTER KNIFE

(1) Center knife actuating position setting procedure

It is possible to set the center knife actuating position by pressing CENTER KNIFE MOTION POSITION SETTING button **A**.

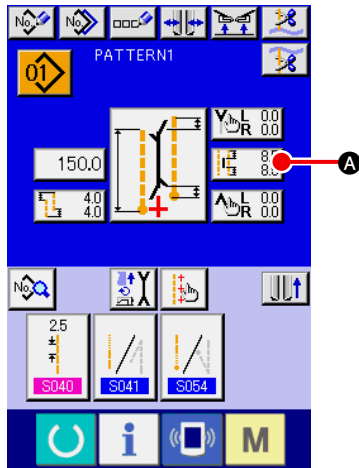

Independent sewing mode
/ cycle sewing mode

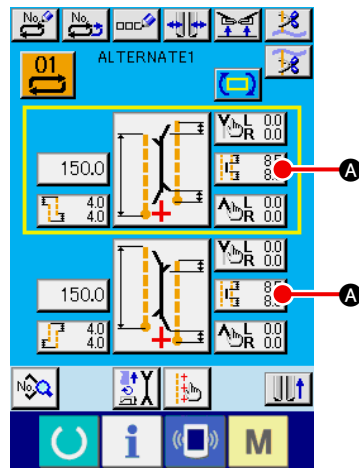

Alternate sewing mode

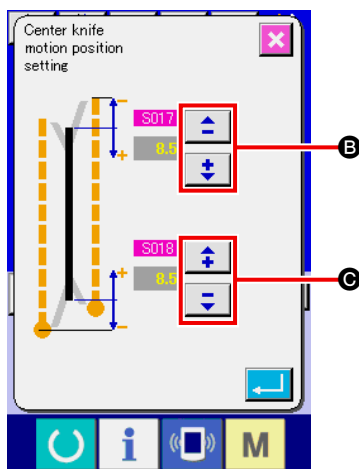

① Setting of the center knife actuating position

There are two kinds of the center knife actuating positions, SEWING START **B** and SEWING END **C** and it is possible to separately set.

It is possible to set by pressing + button and “-” button respectively.



See **S017** and **S018** of "VI-8. (2) Sewing data list" p.51.

(2) Feature of the center knife actuating position setting

- In case of the slant sewing setting, whether the corner knife performs indexing or not makes the setting of center knife actuating position as follows.

Center knife actuating position at the start of sewing :

Index : With **S017** + **M003**

Index : Without **S017**

Center knife actuating position :

Index : With **S018** + **M002**

Index : Without **S018**

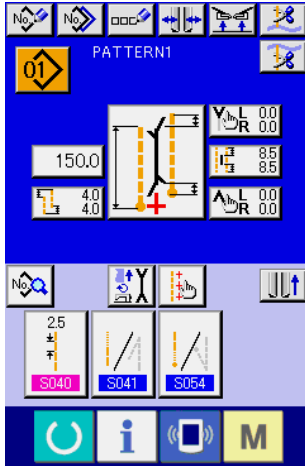

When the corner knife performs indexing, parameter of index excess cut length (**S017** / **S018**) is automatically added in addition to parameter (**M002** / **M003**) of center knife actuating position setting.



When the deflection of left/right corner knives is 4.1 mm or more, the corner knife performs indexing (short corner knife is changed over to long corner knife).

Whether the corner knife performs indexing or not is decided by the deflection setting and the set value of corner knife actuating position setting as shown below.

For the details, see the corner knife actuating position setting procedure.

[Setting of center knife actuating at the start of sewing]

In case of normal setting (corner knife does not perform indexing), screen A is displayed.

When the corner knife performs indexing, screen B instead of screen A is displayed. As shown in screen B, **M003** (parameter of index excess cut length on the moving side/initial value 4.0 mm) is automatically added.

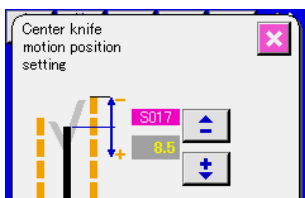

Center knife actuating position setting screen (Screen A)

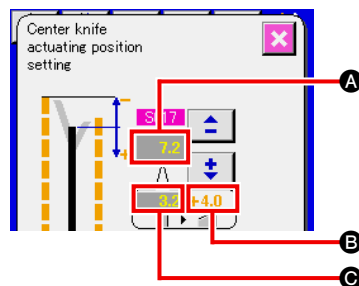

Center knife actuating position setting screen (Screen B)

| | |
|----------|--|
| A | Center knife actuating position at the start of sewing is displayed. (B + C) |
| B | S017 Center knife actuating position at the start of sewing before compensation is displayed. |
| C | M003 Index excess cut length on the moving side (initial value 4.0 mm) is displayed. |



When the sewing type is changed, be sure to use the machine after confirming the positions of corner knife and center knife with trial sewing.

[Setting of center knife actuating position at the end of sewing]

In case of normal setting (corner knife does not perform indexing), screen C is displayed. When the corner knife performs indexing the same as the center knife actuating position at the start of sewing setting, screen D instead of screen C is displayed. As shown in screen D, **M002** Index excess cut length on the fixing side (initial value 4.0 mm) is automatically added.

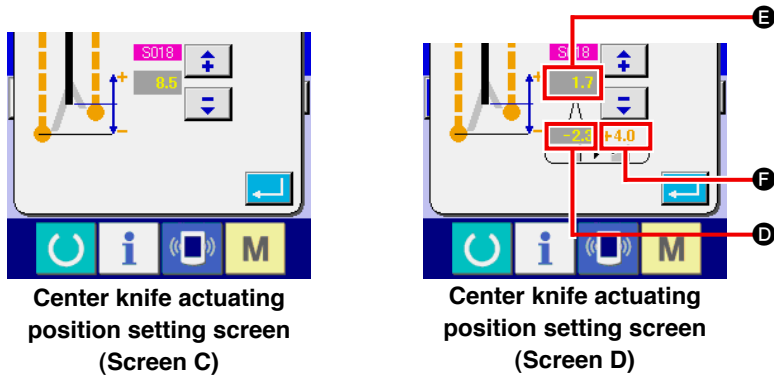

| | |
|----------|--|
| D | Center knife actuating position at the end of sewing is displayed. (E + F) |
| E | S018 Center knife actuating position at the end of sewing before compensation is displayed. |
| F | M002 Index excess cut length on the fixing side (initial value 4.0 mm) is displayed. |



Two kinds of corner knives, long and short, are provided to comply with the slant sewing (For the details, refer to the function of corner knife.)
 For APW-896, center knife cuts at the setting position where the index excess cut length on the traveling side (initial value 4.0 mm) is automatically added to the center knife actuating position at the start of sewing setting. (Fig. A)

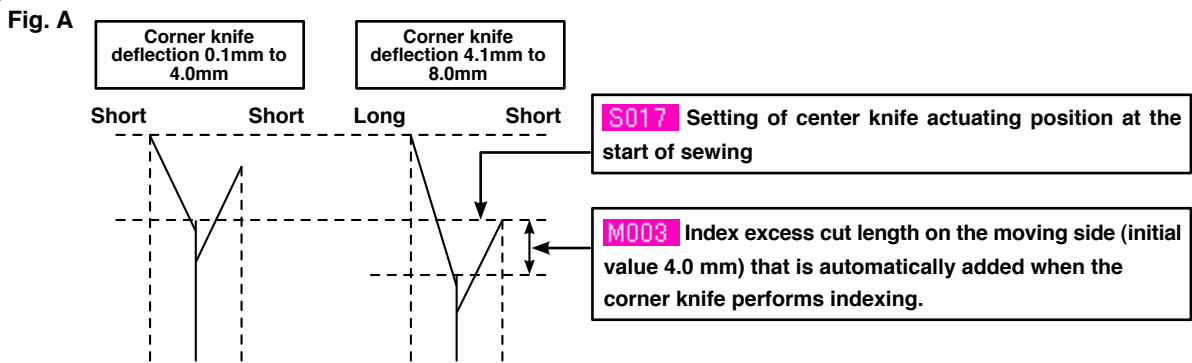

Actuating position of the center knife changes in accordance with long and short corner knives as follows. When changing over from the combination of each short corner knife to the combination of long corner knife and short one, the cutting position of center knife slips if the center knife stays at the same position. (Fig. B)

Therefore, it is necessary to change the cutting position of center knife.

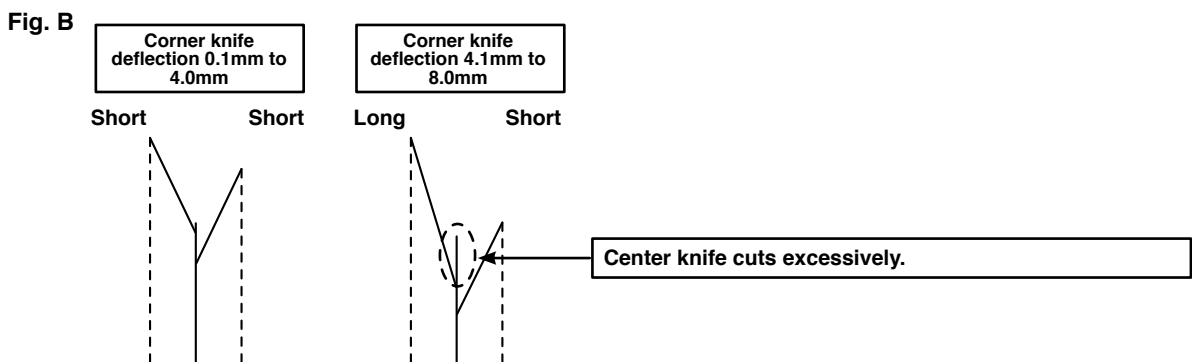

10. ADJUSTING THE POSITION OF THE SENSOR FOR DETECTING FLAPS

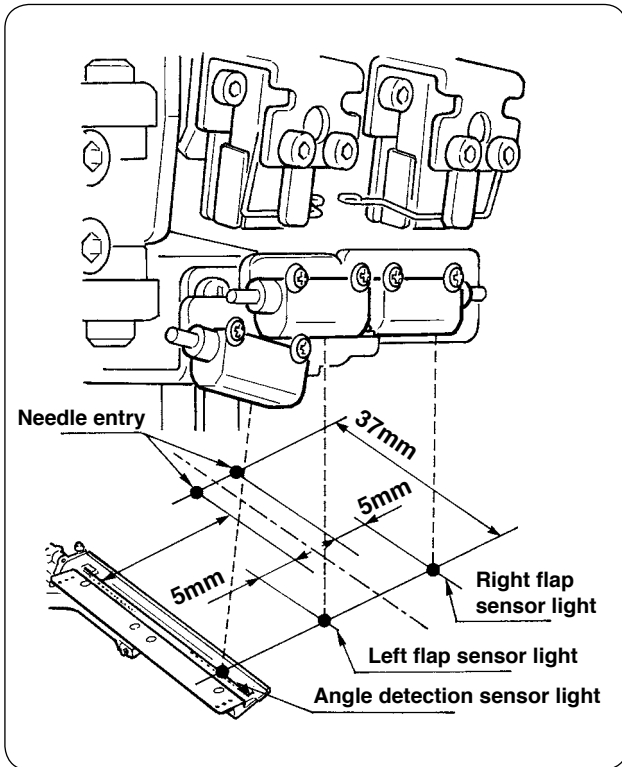

- Adjust the positions of both right and left sensors for detecting flaps to outside of 4.5 to 5 mm from the needle entry and the sewing direction (longitudinal direction) of both right and left sensors to the position of 37 mm from the needle entry on the operator side.
Adjust the position of sensor for detecting flap angle to 0.5mm on the needle center side from the center of the reflecting tape on the flap base and the sewing direction (longitudinal direction) to the position of 37 mm on the operator side.

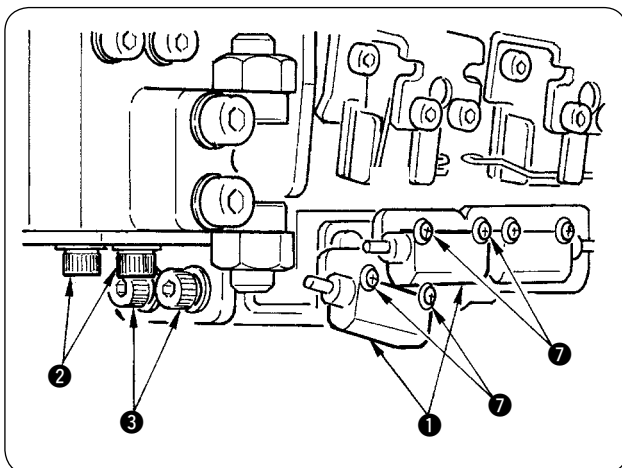

- Adjust the lateral direction of sensor for detecting left flap and flap angle detection sensor ① by loosening setscrews ② and moving the sensors together with sheet metal in the lateral direction.
- Adjust the sewing direction of sensor for detecting left flap and flap angle detection sensor ① by loosening setscrews ③ and moving the sensors in the longitudinal direction.



It is not necessary to loosen setscrews ⑦ when adjusting the position of sensors.

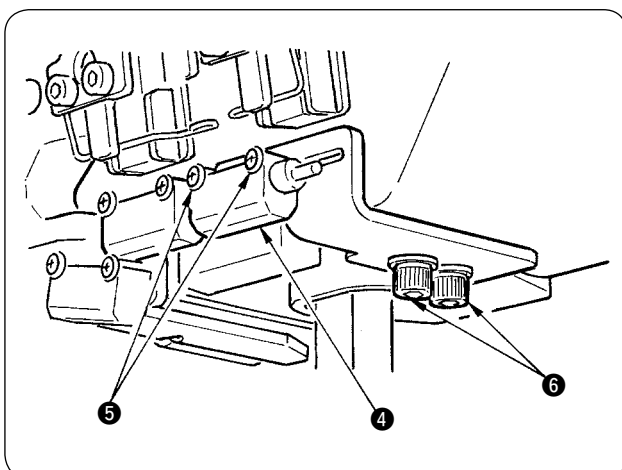

- Adjust the lateral direction of sensor for detecting right flap ④ by loosening setscrews ⑤ and moving the sensor in the lateral direction.
- Adjust the sewing direction of sensor for detecting right flap ④ by loosening screws ⑥ and moving the sensor in the longitudinal direction.



After the adjustment, be sure to perform trial sewing and adjust the flap sewing position with the panel.

11. CAUSES AND CORRECTIVE MEASURES AGAINST TROUBLES WITH THE BOBBIN THREAD REMAINING AMOUNT DETECTING DEVICE

| Phenomenon | Cause | Corrective measure |
|--|--|--|
| <p>1) The bobbin thread remaining amount detecting function fails to work even when the bobbin thread has run out.</p> | <p>① The bobbin thread remaining amount adjusting counter has been improperly set.</p> <p>② The start position of bobbin winding is defective.</p> <p>③ The sensor amplifier fails to turn ON/OFF because of the stained lens.</p> <p>④ Sensor unit installing position.</p> <p>⑤ The bobbin used is not the exclusive one for the bobbin thread remaining amount detecting device.</p> <p>⑥ The bobbin case used is not the exclusive one for the bobbin thread remaining amount detecting device.</p> <p>⑦ The bobbin winder fails to wind the bobbin uniformly.</p> <p>⑧ The sensor cable connection failure.</p> | <p>○ Check the specified data on the bobbin thread remaining adjusting counter "B008". If the value of "B008" is excessive, bobbin thread will run out before bobbin thread remaining amount detection count-up occurs. Refer to "VI-5. USING THE BOBBIN THREAD AMOUNT ADJUSTMENT COUNTER" p.38.</p> <p>○ Start winding a bobbin from the recess designated.</p> <p>○ Check whether the solenoid valve for the bobbin thread remaining amount detecting device operates normally.</p> <p>○ wipe clean the lens surface of the optical fiber unit.</p> <p>○ Check that the spot of sensor light irradiates the position of reflecting tape of bobbin.</p> <p>○ Use the exclusive bobbin for the bobbin thread remaining amount detecting device.</p> <p>○ Use the exclusive bobbin case for the bobbin thread remaining amount detecting device.</p> <p>○ Properly adjust the bobbin winder.</p> <p>○ Check how the sensor scale and MAIN circuit board are connected.</p> |

12. HOW TO ADJUST THE FOOT PEDAL

The foot pedal of this device is so designed that an analog type pedal sensor detects the depressing depth of the foot pedal and the detected voltage value is taken as the operation step of the pedal. However, the voltage value of the pedal sensor changes with a lapse of time. As a result, the depressing depth of the foot pedal can fail to match the operation step of the pedal. In this case, adjust the foot pedal as described below.

In addition, the adjustment value of the pedal is stored in memory of EEP-ROM of MAIN circuit board. If the circuit board is replaced, adjust the foot pedal taking the same procedure.

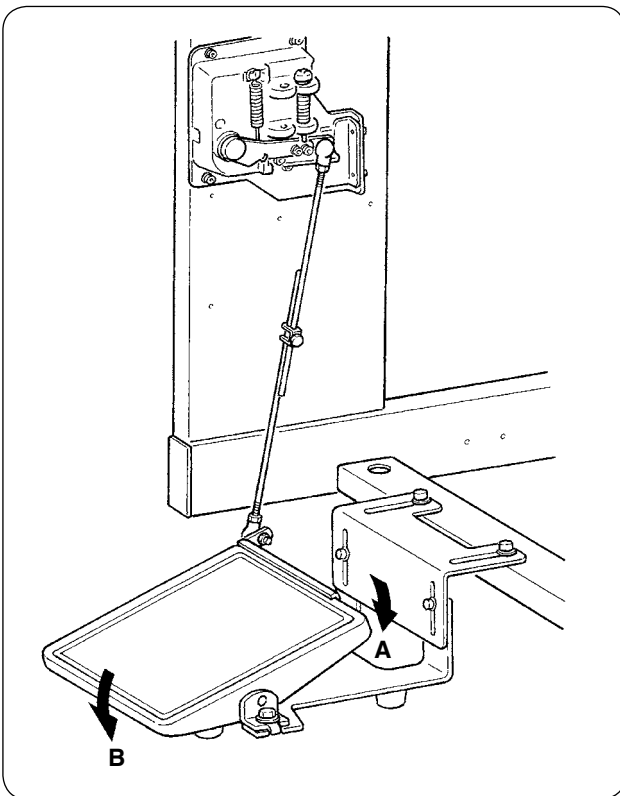

The pedal has 7 steps in the direction A and one step in the direction B.

Perform the panel setting in the respective steps.

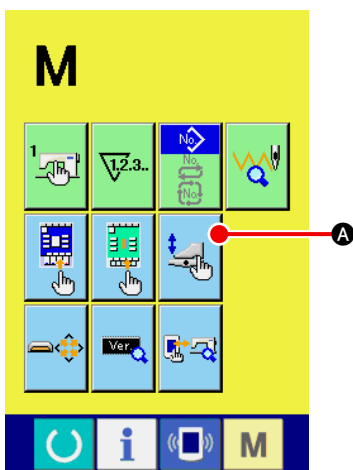

① Display the pedal customizing screen

Keep pressing MODE CHANGE-OVER key **M** for three

seconds and PEDAL CUSTOMIZING button  **A** displayed

on the screen changes the color from green to light blue.

Press this button and the pedal customizing screen of maintenance personnel level is displayed.



- ② When FOOT PEDAL ADJUSTMENT button  **B** is pressed, the foot pedal adjustment screen is displayed and the number of steps in terms of the depressing depth of the foot pedal is set.

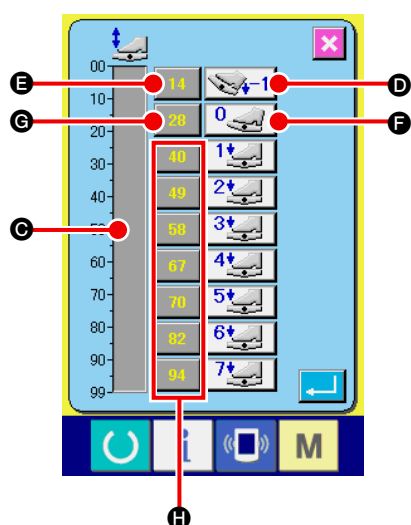









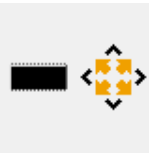
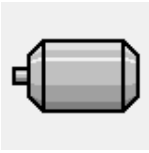

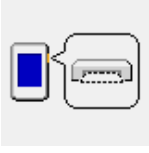





- ③ Pedal sensor voltage value in the present pedal depressing state is displayed in the range of 0 to 99 in the volume bar indication **C**. First, press PEDAL DEPRESSED TO REVERSE STEP INPUT button **D** with the foot pedal depressed to the reverse step. Voltage value of this time is inputted to **E**. Next, press FREE INPUT button **F** with the foot pedal free. Voltage value of this time is inputted to **G**. Using the same procedure, perform setting of first to seventh steps of the foot pedal, and input the voltage value of the respective pedal positions to buttons **E**, **G** and **H**.



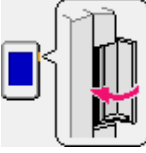
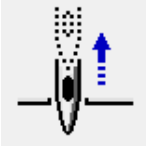

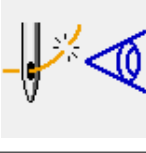

Set the voltage value so as to increase as the number of steps of the foot pedal increases. In addition, when directly pressing button **E**, **G** or **H**, the ten key input screen is displayed, and it is possible to directly input numerals.



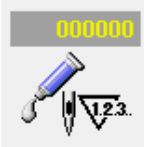
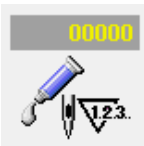
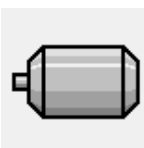
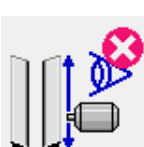

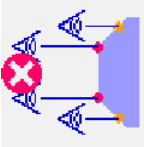
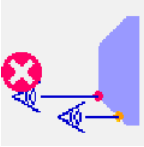
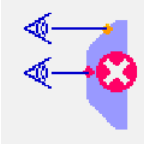
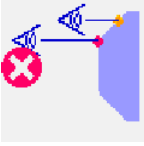
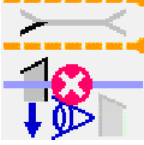

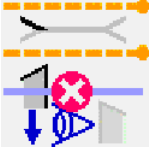
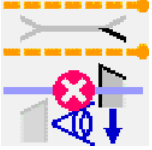
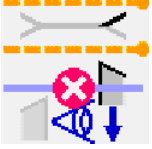
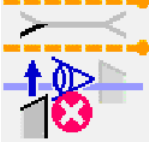
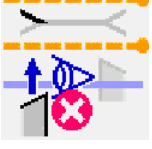
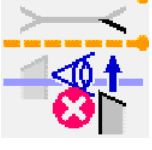
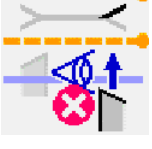
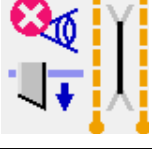
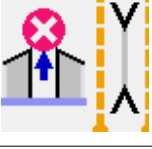

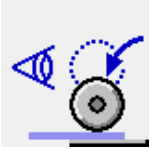

13. ERROR CODE LIST

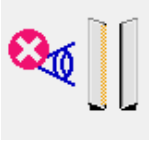

| Error code | | Description of error | How to recover |
|------------|---|---|-----------------------------------|
| E001 |  | Initialization of EEP-ROM of MAIN CPU | Turn OFF the power. |
| E007 |  | Machine-lock Main shaft of the sewing machine does not rotate due to some trouble. | Turn OFF the power. |
| E010 |  | Pattern No. error Pattern No. designated with ten-key is not registered when pattern No. is selected. | Possible to re-start after reset. |
| E011 |  | External media not inserted Media is not inserted. | Possible to re-start after reset. |
| E012 |  | Read error Data read from media cannot be performed. | Possible to re-start after reset. |
| E013 |  | Write error Data write from media cannot be performed. | Possible to re-start after reset. |
| E015 |  | Format error Formatting of media cannot be performed. | Possible to re-start after reset. |
| E016 |  | External media capacity over Capacity of media is short. | Possible to re-start after reset. |
| E022 |  | File No. error Designated file is not in server or media. | Possible to re-start after reset. |
| E024 |  | Pattern data size over Memory size is over. | Possible to re-start after reset. |

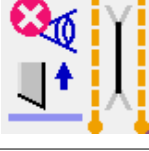

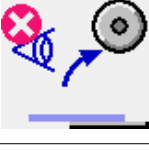



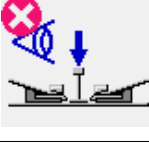

| Error code | | Description of error | How to recover |
|------------|---|---|-----------------------------------|
| E027 |  | Read error Data read from server cannot be performed. | Possible to re-start after reset. |
| E028 |  | Write error Data write from server cannot be performed. | Possible to re-start after reset. |
| E029 |  | Lid of media slot is open. | Possible to re-start after reset. |
| E030 |  | Needle bar upper position failure Needle bar is out of needle UP position. | Possible to re-start after reset. |
| E031 |  | Air pressure drop Air pressure is low. | Possible to re-start after reset. |
| E032 |  | File interchanging error File cannot be read. | Possible to re-start after reset. |
| E045 |  | Pattern data error Pattern data is corrupted. | Possible to re-start after reset. |
| E050 |  | Stop switch When stop switch is pressed. | Possible to re-start after reset. |
| E052 |  | Thread breakage detection error When thread breakage is detected. | Possible to re-start after reset. |
| A201 |  | Needle replacing time warning When number of stitches of operation is reached to number of stitches of needle replacement that is set from the panel. | Possible to re-start after reset. |
| A202 |  | Cleaning time warning When operation time of the sewing machine is reached to the cleaning time that is set from the panel. | Possible to re-start after reset. |

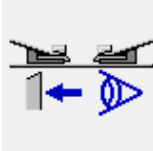



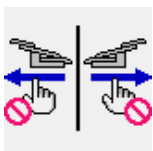

| Error code | | Description of error | How to recover |
|------------|---|--|-----------------------------------|
| A203 |  | Oil replacement time warning When operation time of the sewing machine is reached to the oil replacement time that is set from the panel. | Possible to re-start after reset. |
| E220 |  | Grease-up warning When number of stitches of operation is reached to 40 million stitches. | Possible to re-start after reset. |
| E221 |  | Grease-up error When number of stitches of operation is reached to 48 million stitches, a sewing impossible state occurs. * After applying grease, it is possible to release when clearing memory switch U245 Number of stitches of grease-up. | Possible to re-start after reset. |
| E303 |  | Semilunar plate sensor error Detection of upper dead point of the sewing machine cannot be performed. | Turn OFF the power. |
| E349 |  | Step-out detection sensor does not react. For the emergency procedure, it is possible to continually use by re-starting with the reset button. However, check the sensor and be sure to replace it when it is defective. | Possible to re-start after rest. |
| E351 |  | Reflecting tape for detecting angle has been deteriorated. | Possible to re-start after reset. |
| E353 |  | Angle detection sensor fails to detect. * Clean dust on the reflecting tape of the flap base with an air gun. | Possible to re-start after reset. |
| E354 |  | Angle detection sensor forced stop | Possible to re-start after reset. |
| E355 |  | Angle detection sensor dust detection * Clean dust on the reflecting tape of the flap base with an air gun. | Possible to re-start after reset. |
| E356 |  | Angle detection sensor front end fails to detect. | Possible to re-start after reset. |
| E357 |  | Corner knife on the moving side, left is held lifted. | Possible to re-start after reset. |

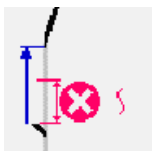
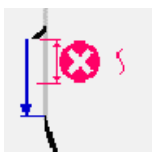
| Error code | | Description of error | How to recover |
|------------|---|---|-----------------------------------|
| E358 |  | Corner knife on the moving side, right is held lifted. | Possible to re-start after reset. |
| E359 |  | Corner knife on the fixing side, left is held lifted. | Possible to re-start after reset. |
| E360 |  | Corner knife on the fixing side, right is held lifted. | Possible to re-start after reset. |
| E361 |  | Corner knife on the moving side, left fails to lift. | Possible to re-start after reset. |
| E362 |  | Corner knife on the moving side, right fails to lift. | Possible to re-start after reset. |
| E363 |  | Corner knife on the fixing side, left fails to lift. | Possible to re-start after reset. |
| E364 |  | Corner knife on the fixing side fails to lift. | Possible to re-start after reset. |
| E366 |  | Center knife does not lower. | Possible to re-start after reset. |
| E367 |  | Corner knife cannot be entered. | Possible to re-start after reset. |
| E368 |  | Zipper has run out. | Possible to re-start after reset. |
| E369 |  | Roller stacker lower end sensor does not detect. | Possible to re-start after reset. |

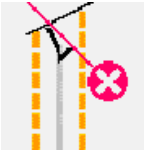
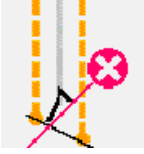
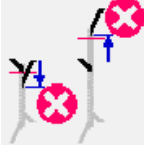
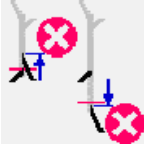

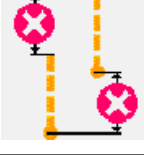
| Error code | | Description of error | How to recover |
|------------|---|---|-----------------------------------|
| E370 |  | Roller stacker lower end sensor is gone past. | Possible to re-start after reset. |
| E371 |  | Clamp bar stacker material presser sensor is gone past. | Possible to re-start after reset. |
| E372 |  | Clamp bar stacker material sweeper origin sensor is gone past. | Possible to re-start after reset. |
| E373 |  | Reflecting tape on right-hand side is deteriorated. | Possible to re-start after reset. |
| E374 |  | Reflecting tape on left-hand side is deteriorated. | Possible to re-start after reset. |
| E376 |  | Pedal continuous depressing error | Possible to re-start after reset. |
| E377 |  | Center knife upper detection sensor cannot detect. | Possible to re-start after reset. |
| E378 |  | Clamp bar stacker open detection | Possible to re-start after reset. |
| E379 |  | Roller stacker lift sensor cannot detect. | Possible to re-start after reset. |
| E380 |  | Flap sensor cannot receive light | Possible to re-start after reset. |
| E381 |  | Flap rear end cannot be detected (forced stop). Error is displayed after end of sewing. | Possible to re-start after reset. |



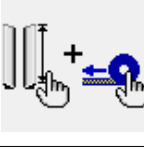

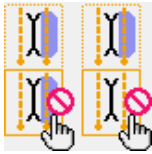
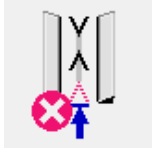
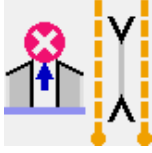
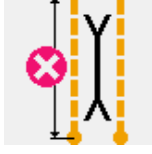
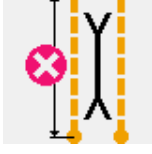
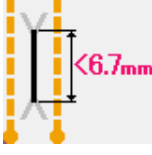
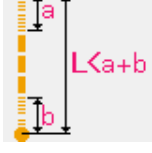
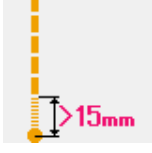
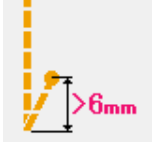
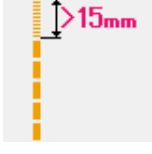
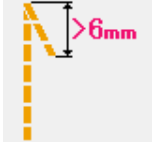

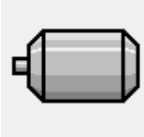
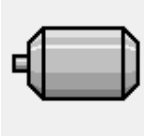
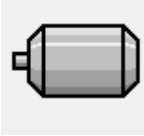
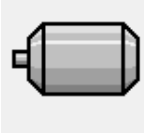
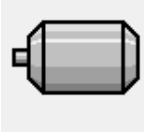
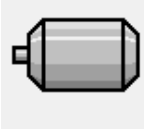
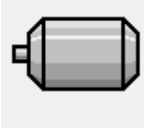
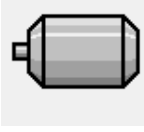

| Error code | | Description of error | How to recover |
|------------|---|--|------------------------------------|
| E382 |  | Flap dust detection error | Possible to re-start after reset. |
| E383 |  | Flap front end cannot be detected. | Possible to re-start after reset. |
| E386 |  | Corner knife fixing side bottom detection error | Possible to re-start after reset. |
| E387 |  | Corner knife fixing side top detection error | Possible to re-start after reset. |
| E388 |  | Corner knife moving side bottom detection error | Possible to re-start after reset. |
| E389 |  | Corner knife moving side top detection error | Possible to re-start after reset. |
| E390 |  | Material sensor error Material remains after end of stacker operation. | Automatic recovery by sensor input |
| E391 |  | ST material presser lift detection error | Automatic recovery by sensor input |
| E392 |  | ST material sweeper origin detection error | Automatic recovery by sensor input |
| E393 |  | Binder bottom detection error | Automatic recovery by sensor input |
| E394 |  | Binder top detection error | Automatic recovery by sensor input |

| Error code | | Description of error | How to recover |
|------------|---|--|--|
| E398 |  | Corner knife drawer detection error | Possible to re-start after reset. |
| E399 |  | Binder open detection error | Possible to re-start after reset. |
| E401 |  | Copy disapproved When trying to perform overwriting copy on the pattern No. which has been already registered | Possible to recover with CANCEL button |
| E402 |  | Erasing disapproved When trying to delete the pattern used in the cycle sewing | Possible to recover with CANCEL button |
| E403 |  | New creation disapproved When the registered pattern is selected to the new creation pattern No. | Possible to recover with CANCEL button |
| E404 |  | Data of designated No. does not exist. When data of designated No. does not exist in media or server | Possible to recover with CANCEL button |
| E435 | --- | Erasing disapproved When trying to erase pattern registered to direct pattern. | Possible to re-start after reset. |
| E474 |  | It cannot be used with single welt setting. S033 S034 Sewing cannot be performed with the single-welt setting when the automatic deflection detecting function is being used. | Possible to re-start after reset. |
| E475 |  | Flap priority sewing mode selection at the time of slant flap sewing is disapproved. At the time of independent sewing or cycle sewing, when flap priority sewing is selected with slant flap, error occurs. | Possible to re-start after reset. |
| E476 |  | Clearance length between corner knives on the moving side error | Possible to re-start after reset. |
| E477 |  | Clearance length between corner knives on the fixing side error | Possible to re-start after reset. |

| Error code | | Description of error | How to recover |
|------------|---|---|-----------------------------------|
| E478 |  | Deflection direction of corner knives on the moving side error | Possible to re-start after reset. |
| E479 |  | Deflection direction of corner knives on the fixing side error | Possible to re-start after reset. |
| E480 |  | Max. value of clearance between corner knives on the moving side error | Possible to re-start after reset. |
| E481 |  | Max. value of clearance between corner knives on the fixing side error | Possible to re-start after reset. |
| E482 |  | Range of flap angle detection is exceeded. | Possible to re-start after reset. |
| E483 |  | Input deflection amount exceeds the limit. | Possible to re-start after reset. |
| E484 |  | Zipper attaching data cannot be sewn. | Possible to re-start after reset. |
| E485 |  | Data other than zipper attaching data cannot be sewn. | Possible to re-start after reset. |
| E486 |  | Flap sewing data cannot be sewn. | Possible to re-start after reset. |
| E487 |  | Both long presser and endless zipper are simultaneously selected. | Possible to re-start after reset. |
| E488 | ... | The gauge size exceeds the input range. | Possible to re-start after reset. |

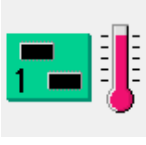
| Error code | | Description of error | How to recover |
|------------|---|---|-----------------------------------|
| E489 |  | Combination data other than right/left flap sewing is set at the time of flap priority setting of alternate sewing mode. | Possible to re-start after reset. |
| E490 |  | It is not possible to feed up to corner knife position. When flap is put on this side in case of the long type | Possible to re-start after reset. |
| E491 |  | Corner knife length is too short. When knife cannot be entered since the interval of corner knife is short. | Possible to re-start after reset. |
| E492 |  | L size length is too short. When sewing cannot be performed since the inputted L size length is too short | Possible to re-start after reset. |
| E493 |  | L size length is too long. When sewing cannot be performed since the inputted L size length is too long. | Possible to re-start after reset. |
| E494 |  | Center knife length error When center knife length is smaller than knife size of 6.7 mm | Possible to re-start after reset. |
| E495 |  | Length at sewing start/sewing end over When sewing length is shorter than the total of length of each condensation (back tack) at sewing start and sewing end | Possible to re-start after reset. |
| E496 |  | Condensation at sewing end length over When condensation pitch X number of stitches exceeds 15.0 mm | Possible to re-start after reset. |
| E497 |  | Back tack at sewing end length over When back tack pitch X number of stitches exceeds 6.0 mm | Possible to re-start after reset. |
| E498 |  | Condensation at sewing start length over When condensation pitch X number of stitches exceeds 15.0 mm | Possible to re-start after reset. |
| E499 |  | Back tack at sewing end length over When back tack pitch X number of stitches exceeds 6.0 mm | Possible to re-start after reset. |

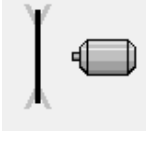
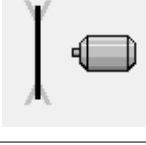
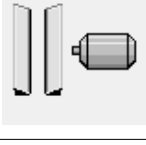
| Error code | | Description of error | How to recover |
|------------|---|--|-----------------------------------|
| E702 |  | CPU runaway detection When program abnormality has occurred in CPU | Turn OFF the power. |
| E703 |  | Panel is connected to the sewing machine which is not supposed (Machine type error) When the machine type between panel and sewing machine is different in the initial communication | Possible to re-start after reset. |
| E704 |  | Inconsistency of system version When system software version is inconsistent in the initial communication | Turn OFF the power. |
| E730 |  | Main shaft motor is defective or lacking for phases. When encoder of sewing machine motor is abnormal | Turn OFF the power. |
| E731 |  | Main motor hole sensor is defective or position sensor is defective. When hole sensor of sewing machine motor or position sensor is defective | Turn OFF the power. |
| E733 |  | Reverse rotation of main shaft motor When the sewing machine motor rotates in the reverse direction | Turn OFF the power. |
| E802 |  | Power momentary cut detection When input power is momentarily cut | Turn OFF the power. |
| E811 |  | Overvoltage of power error When input power is more than the specified value | Turn OFF the power. |
| E813 |  | Low voltage of power error When input power is less than the specified value | Turn OFF the power. |
| E901 |  | Main shaft motor IPM abnormality When SERVO CONTTROL circuit board is abnormal | Turn OFF the power. |
| E903 |  | Stepping motor power (50V) abnormality When stepping motor power of SERVO CONTROL circuit board fluctuates more than $\pm 15\%$ | Turn OFF the power. |

| Error code | | Description of error | How to recover |
|------------|---|---|-----------------------------------|
| E904 |  | Solenoid power (33V) abnormality When solenoid power of SERVO CONTROL circuit board fluctuates more than $\pm 15\%$ | Turn OFF the power. |
| E905 |  | Heat sink temperature for SERVO CONTROL circuit board abnormality Turn ON the power again after taking time. | Turn OFF the power. |
| E915 |  | Communication abnormality between operation panel and MAIN CPU When abnormality occurs in data communication | Turn OFF the power. |
| E916 |  | Communication abnormality between MAIN CPU and main shaft CPU When abnormality occurs in data communication | Turn OFF the power. |
| E917 |  | Communication abnormality between operation panel and personal computer When abnormality occurs in data communication | Possible to re-start after reset. |
| E918 |  | MAIN circuit board heat sink temperature abnormality Turn ON the power again after taking time. | Turn OFF the power. |
| E943 |  | Defective EEP-ROM of MAIN CPU When data writing to EEP-ROM cannot be performed | Turn OFF the power. |
| E983 |  | Center knife motor lock detection | Turn OFF the power. |
| E984 |  | Center knife motor abnormality | Turn OFF the power. |
| E985 |  | Clamp foot motor step-out error | Possible to re-start after reset. |
| E986 |  | Clamp foot stepping motor origin retrieval error | Possible to re-start after reset. |

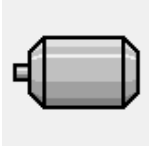
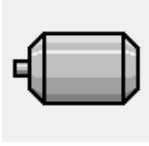
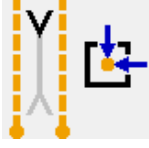
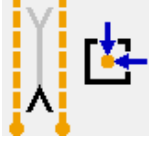
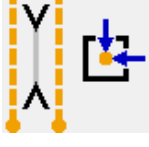
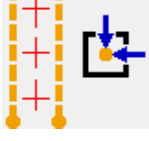
| Error code | | Description of error | How to recover |
|------------|---|---|-----------------------------------|
| E987 |  | Back tack motor origin retrieval error | Possible to re-start after reset. |
| E988 |  | Pocket bag flap detecting motor origin-retrieval error | Possible to re-start after reset. |
| E992 |  | Corner knife motor origin-retrieval error | Possible to re-start after reset. |
| E996 |  | Corner knife index on the moving side motor origin retrieval error | Possible to re-start after reset. |
| E997 |  | Corner knife index on the fixing side motor origin retrieval error | Possible to re-start after reset. |
| E998 |  | Corner knife stepping motor origin retrieval error | Possible to re-start after reset. |
| E999 |  | Marking light motor origin retrieval error | Possible to re-start after reset. |

14. INPUT NUMBER TABLE

| Name | Connecting connector No. |
|---|--------------------------|
| Air pressure detection | MAIN CN-30 |
| Origin sensor on marking light fine adjustment side | MAIN CN-36-6 |
| Corner knife motor origin sensor | MAIN CN-37-6 |
| Back tack motor origin sensor | MAIN CN-38-6 |
| Thread breakage detection (left) | INTA CN62A-2 |
| Thread breakage detection (right) | INTA CN63A-2 |
| Material sensor | INTA CN65A-3 |
| Clamp foot step-out detection | INTA CN66A-3 |
| Binder open detection | INTA CN68A-1 |
| Binder up detection | INTA CN71A-3 |
| Marking light origin sensor | INTA CN75A-2 |
| Clamp foot origin detection | INTA CN77A-2 |
| Center knife lift detection | INTA CN79A-1 |
| Flap sensor (left) | INTB CN60B-2 |
| Flap sensor (right) | INTB CN61B-2 |
| Corner knife drawer detection switch | INTB CN62B-2 |
| Bobbin thread remaining amount detection (left) | INTB CN64B-2 |
| Bobbin thread remaining amount detection (right) | INTB CN64B-5 |
| Start switch | INTB CN65B-3 |
| Temporary stop switch | INTB CN69B-1 |
| Pedal volume sensor | INTB CN75B-2 |
| Roller lift detection | INTB CN83A-19 |
| Stacker open detection | INTB CN83B-13 |
| Stacker origin | INTB CN83B-15 |
| Corner knife fixing side, right lifting detection | INTB CN79B |
| Corner knife fixing side, right lowering detection | INTB CN80B |
| Corner knife fixing side, left lifting detection | INTB CN81B |
| Corner knife fixing side, left lowering detection | INTB CN82B |
| Corner knife moving side, left lowering detection | MAIN CN125-2 |
| Corner knife moving side, left lifting detection | MAIN CN125-5 |
| Corner knife moving side, right lowering detection | MAIN CN126-2 |
| Corner knife moving side, right lifting detection | MAIN CN126-5 |
| Fixing side index motor origin | MAIN CN127 |
| Moving side index motor origin | MAIN CN128 |
| Flap angle detection sensor | INTB CN63B-2 |