

JUKI®

Super Automatic Zigzag Sewing Machine
NZ-120

INSTRUCTION MANUAL

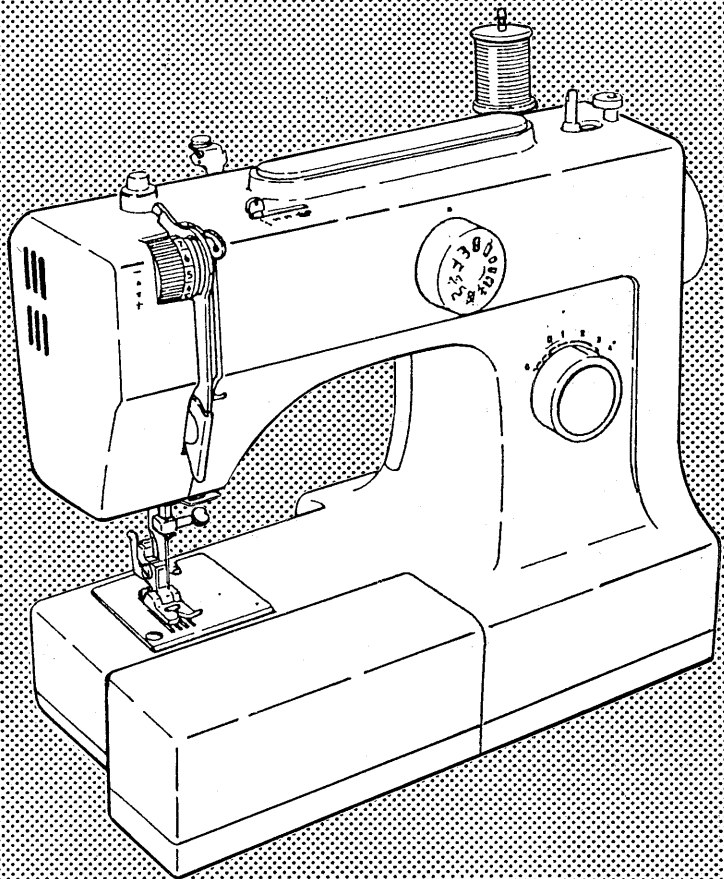

“IMPORTANT SAFEGUARDS”

“IMPORTANT SAFETY INSTRUCTIONS”

“When using an electrical appliance, basic safety precautions should always be followed, including the following:”

“Read all instructions before using this sewing machine.”

“DANGER _____ To reduce the risk of electric shock:”

1. “An appliance should never be left unattended when plugged in. Always unplug this appliance from the electric outlet immediately after using and before cleaning.”
2. “Always unplug before relamping. Replace bulb with same type rated 15 Watts.”

“WARNING _____ To reduce the risk of burns, fire, electric shock, or injury to persons:”

1. “Do not allow to be used as a toy. Close attention is necessary when this appliance is used by or near children.”
2. “Use this appliance only for its intended use as described in this manual. Use only attachments recommended by the manufacturer as contained in this manual.”
3. “Never operate this appliance if it has a damaged cord or plug, if it is not working properly, if it has been dropped or damaged, or dropped into water. Return the appliance to the nearest authorized dealer or service center for examination, repair, electrical or mechanical adjustment.”
4. “Never operate the appliance with any air openings blocked. Keep ventilation openings of the sewing machine and foot controller free from the accumulation of lint, dust, and loose cloth.”
5. “Keep fingers away from all moving parts. Special care is required around the sewing machine needle.”
6. “Always use the proper needle plate. The wrong plate can cause the needle to break.”
7. “Do not use bent needles.”
8. “Do not pull or push fabric while stitching. It may deflect the needle causing it to break.”
9. “Switch the sewing machine off (“0”) when making any adjustments in the needle area, such as threading needle, changing needle, threading bobbin, or changing presser foot, and the like.”
10. “Always unplug sewing machine from the electrical outlet when removing covers, lubricating, or when making any other user servicing adjustments mentioned in the instruction manual.”
11. “Never drop or insert any object into any opening.”
12. “Do not use outdoors.”
13. “Do not operate where aerosol (spray) products are being used or where oxygen is being administered.”
14. “To disconnect, turn all controls to the off (“0”) position, then remove plug from outlet.”
15. “Do not unplug by pulling on cord. To unplug, grasp the plug, not the cord.”

“SAVE THESE INSTRUCTIONS”

“This sewing machine is intended for household use only.”

Be sure to disconnect the plug from the wall outlet before replacing the sewing machine needle, or lubricating the machine.

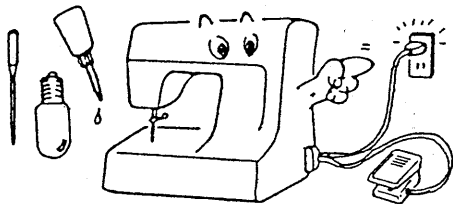

When not in use, be sure unplug the machine.

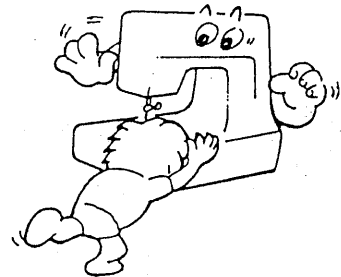

Do not use thinner or other similar solvents to clean the machine.

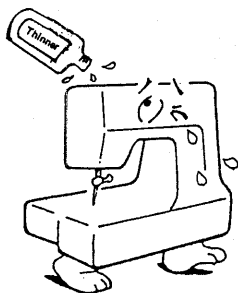

Do not expose the machine to direct sunlight or humid atmosphere.

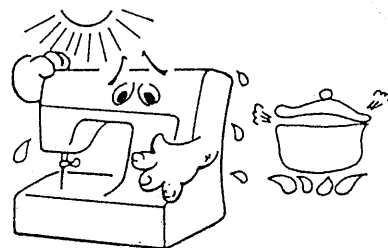

■ CONTENTS

Important safeguards	1	Overcasting	11
Accessories	2	Inserting zippers	11
Principal parts	3	Stretch stitch	12
Major functions	4	Blindstitch	12
Winding the bobbin	5	Rolled hemming	12
Threading the machine	6	Patch work	13
Changing the presser feet	7	How to use the ruler for quilting	13
How to remove and insert the needle	7	Cleaning	13
Types of feet and their application	7	How to remove the face cover	13
How to adjust thread tension	8	List of stitching, stitch pattern, width, length and presser foot	14
How to adjust the bobbin case	8	Lubricating the machine	14
List of fabric, thread and needle	8	Performance checklist	Back cover
Straight stitch	9		
Reverse stitch	9		
Zigzag stitch	10		
Stitch width vs stitch length			
Buttonholes	10		

■ Accessories

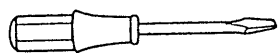

Screwdriver (S. M)

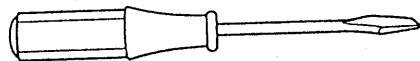

Oiler

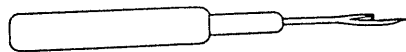

Seam ripper



Zigzag stitch foot



Straight stitch foot

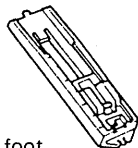

Buttonhole foot



Overcasting foot



Zipper foot

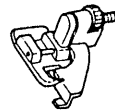

Blindstitch presser foot (D)



Rolled hemming foot

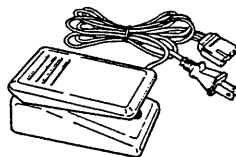

Speed controller



Needle pack
(HAX1 No. 11 2P.
No. 14 1P.)



Bobbins (3)

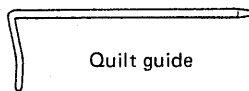

Quilt guide

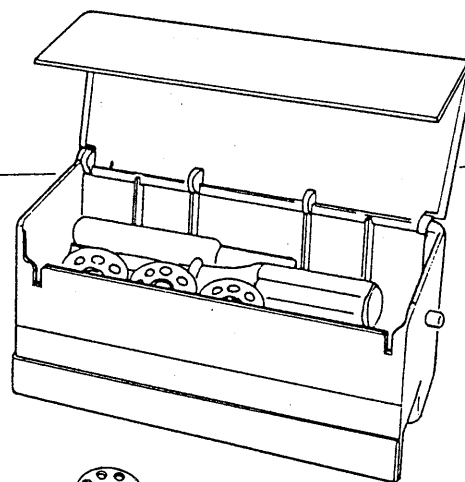

Accessory box
(Auxiliary bed)



Felt
(for spool)

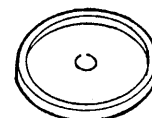

Spool support

Note: Zigzag stitch foot: The sewing machine is shipped from the factory with this presser foot attached.

■ Principal Parts

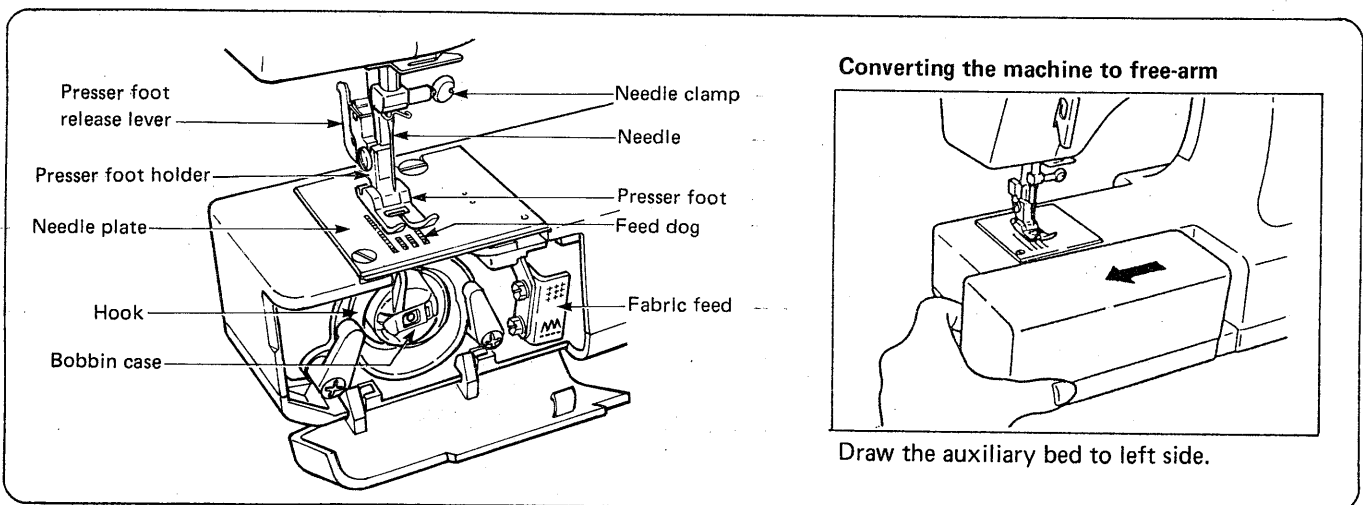
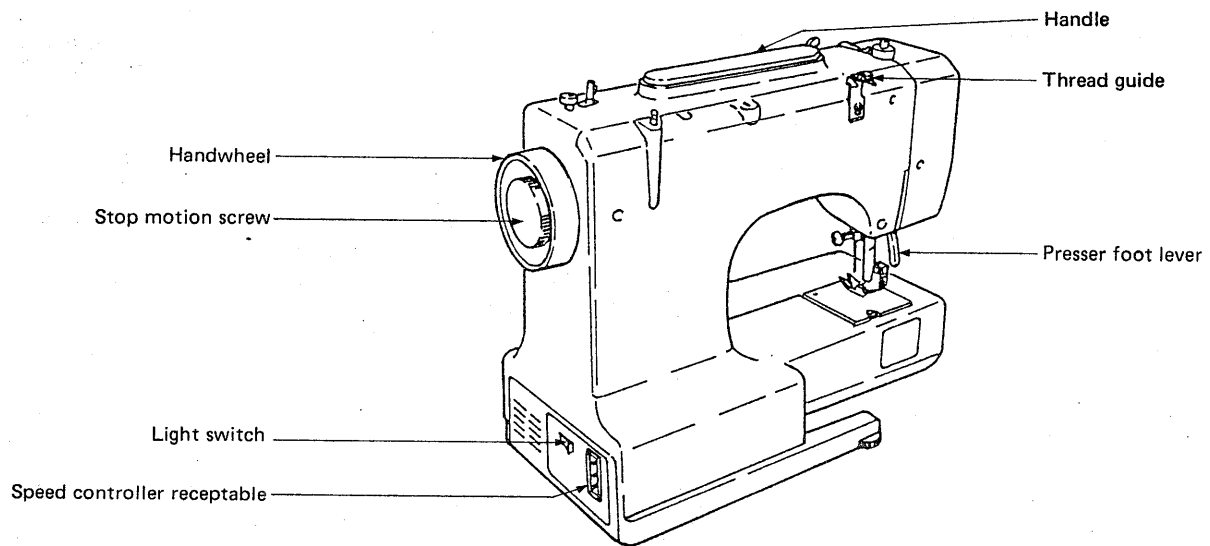
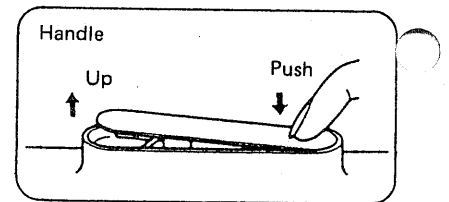
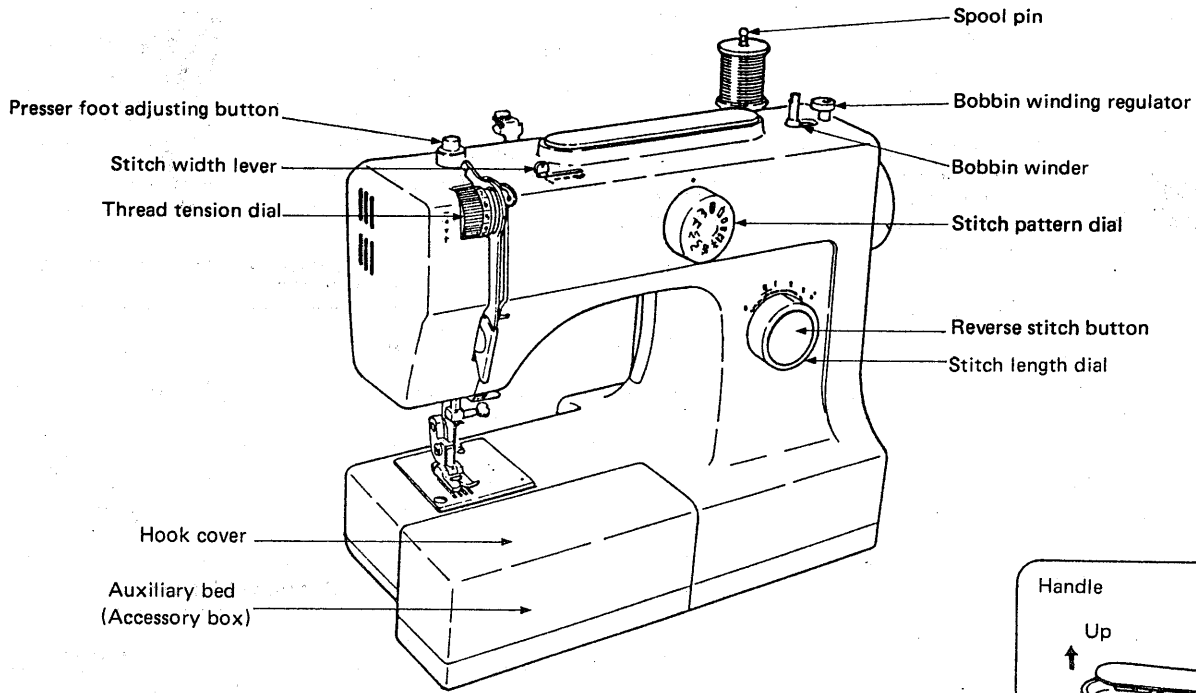

■ Major Functions

Speed controller

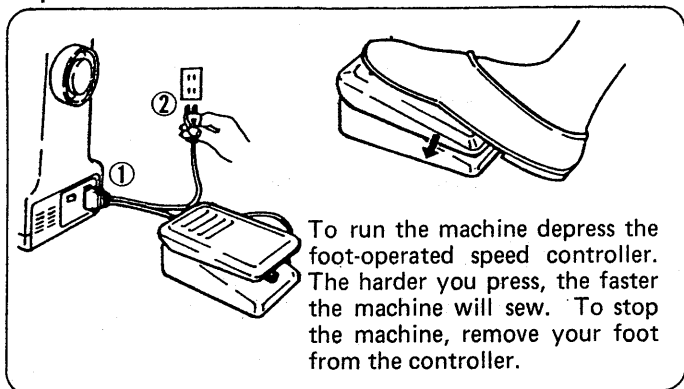

To run the machine depress the foot-operated speed controller. The harder you press, the faster the machine will sew. To stop the machine, remove your foot from the controller.

Push speed controller plug into receptacle at the right end of the machine.
Plug power cord into electric outlet.

Presser foot lever

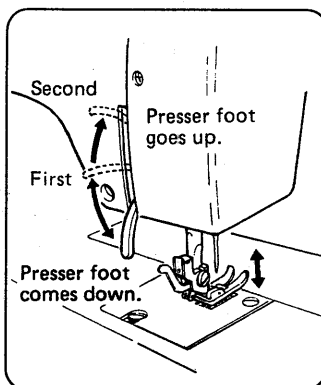

It comes with a double-step presser foot. When the presser foot is raised to the first step, the presser foot is raised to the first step, the needle thread does not loosen. When the presser foot is raised to the second step, the needle thread tension loosens.

Thread tension dial

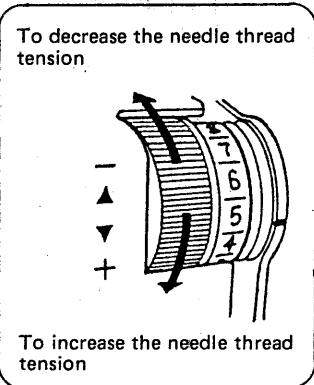

To decrease the needle thread tension

To increase the needle thread tension

Stitch pattern dial

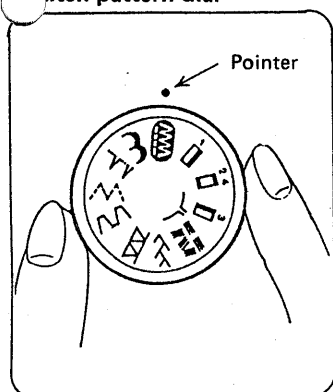

Stitch length dial

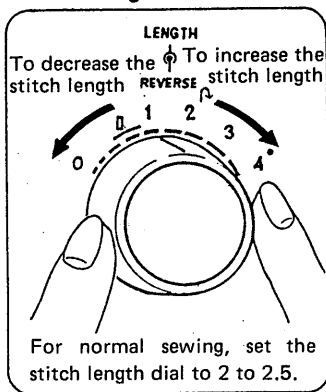

For normal sewing, set the stitch length dial to 2 to 2.5.

Reverse stitch button

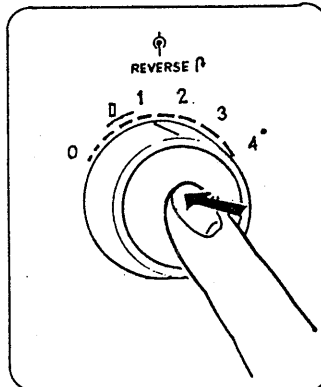

The reverse stitch is used at the beginning and end of a seam to secure it.

Stitch width lever

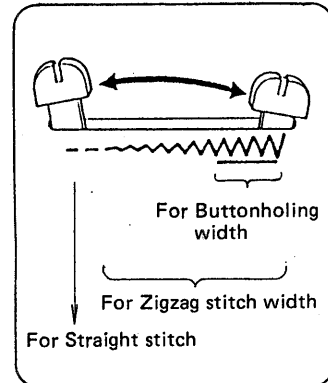

Stop-motion screw

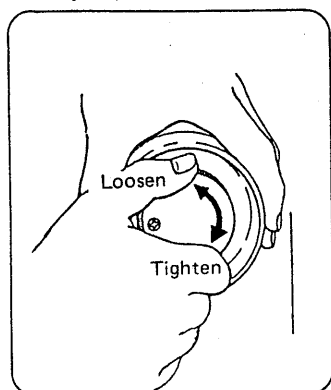

When winding the bobbin, loosen the stop-motion screw. Then the needle do not move.

Presser foot pressure button

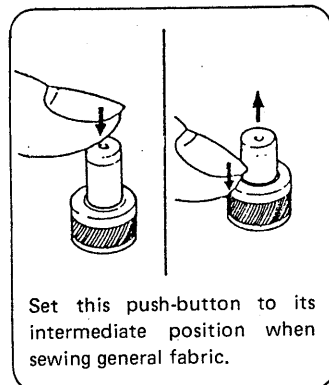

Adjust the pressure of the presser foot in accordance with the type and thickness of the material to be sewn.

Fabric feed lever

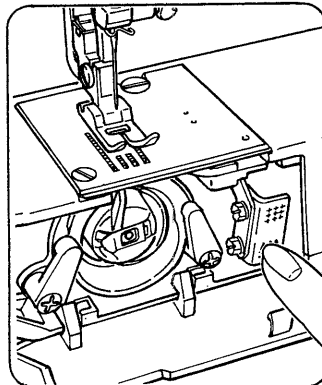

Press the lower section of the fabric feed lever for normal sewing.
Press the upper section of the lever for embroidering or darning. (In this case, the material is not fed.)

Light switch

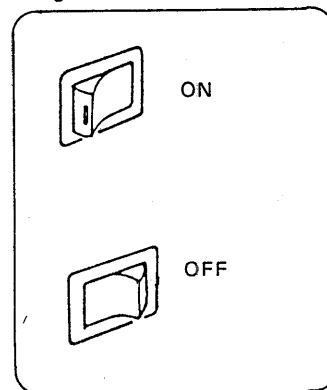

Winding The Bobbin
Threading for winding the bobbin

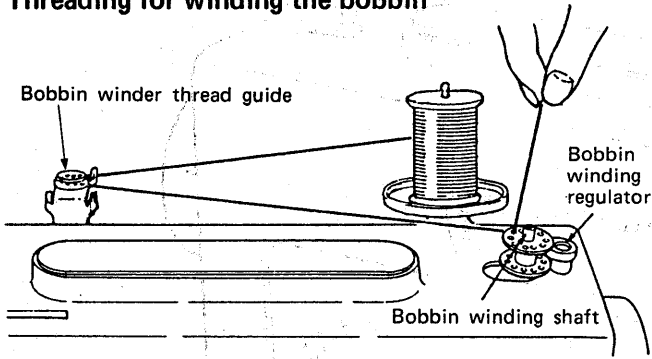

1 Convert machine to free arm.

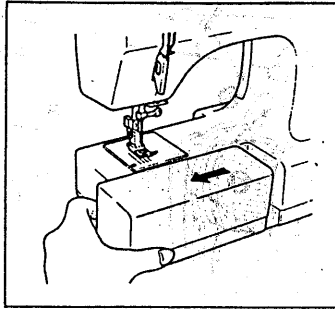

2 Open the hook cover.

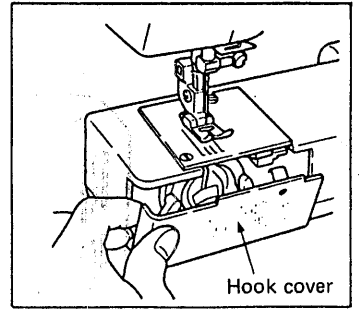

3 Take out the bobbin case.

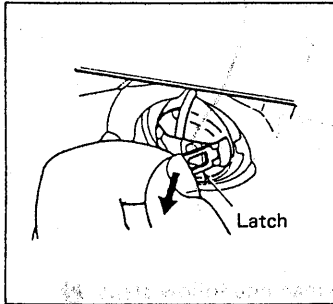

4 Close latch and the bobbin will drop out of the bobbin case.

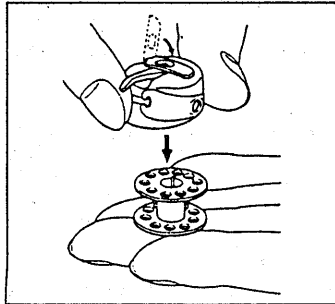

5 Loosen the stop-motion screw.

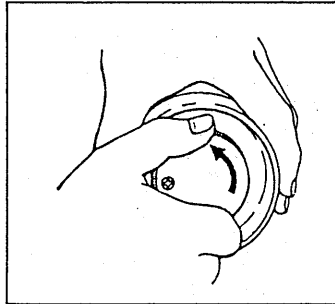

6 Place the spool onto the spool pin.

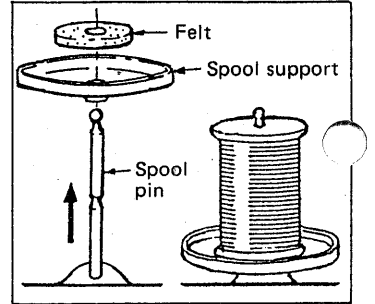

- (1) Be sure that the needle is up.
- (2) Open the latch of the bobbin case, and remove.

This will prevent the needle from moving.

Take up the spool pin, place the spool support and the felt onto the spool pin.

7 Hook the thread onto the bobbin winder thread guide.

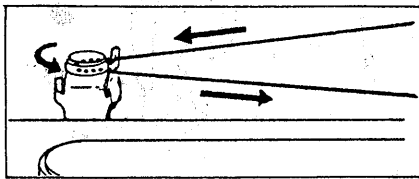

8 Place the bobbin on the bobbin winding shaft.

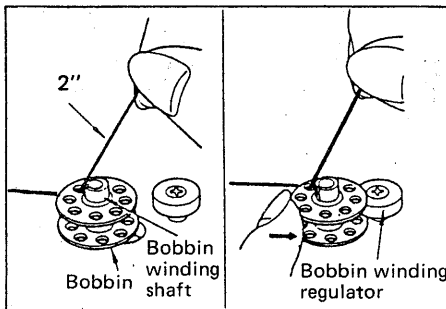

9

10 Push the bobbin back to the left.

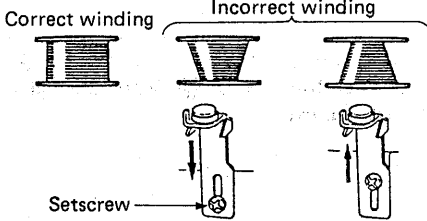
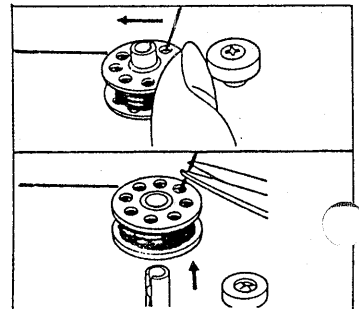

Adjust the position of the screw by moving it in the direction of the arrow.

Press the bobbin against the winding regulator.

Depress speed controller to wind bobbin.

Cut the thread and take the bobbin off the shaft.

11 Tighten the stop-motion screw.

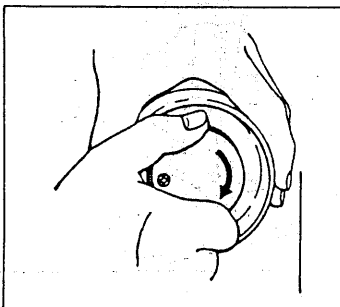

Be sure to firmly tighten the screw.

12 Place the bobbin in bobbin case.

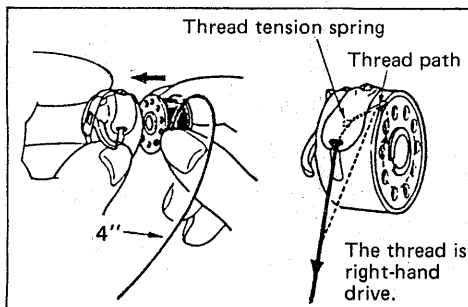

Pass the thread out through the thread path.

13 Replace the bobbin case into machine.

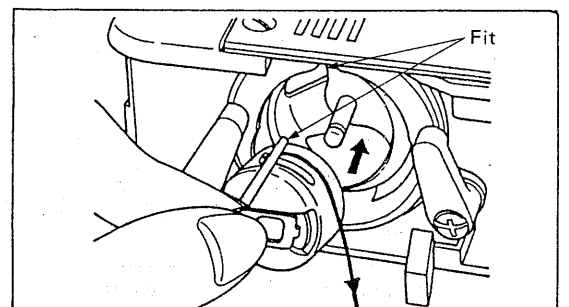

- (1) Fully open the latch, and securely fit the bobbin case into the hook.
- (2) Snap the latch closed on the bobbin case.
- (3) Close the hook cover.

■ **Threading The Machine**
How to thread the machine

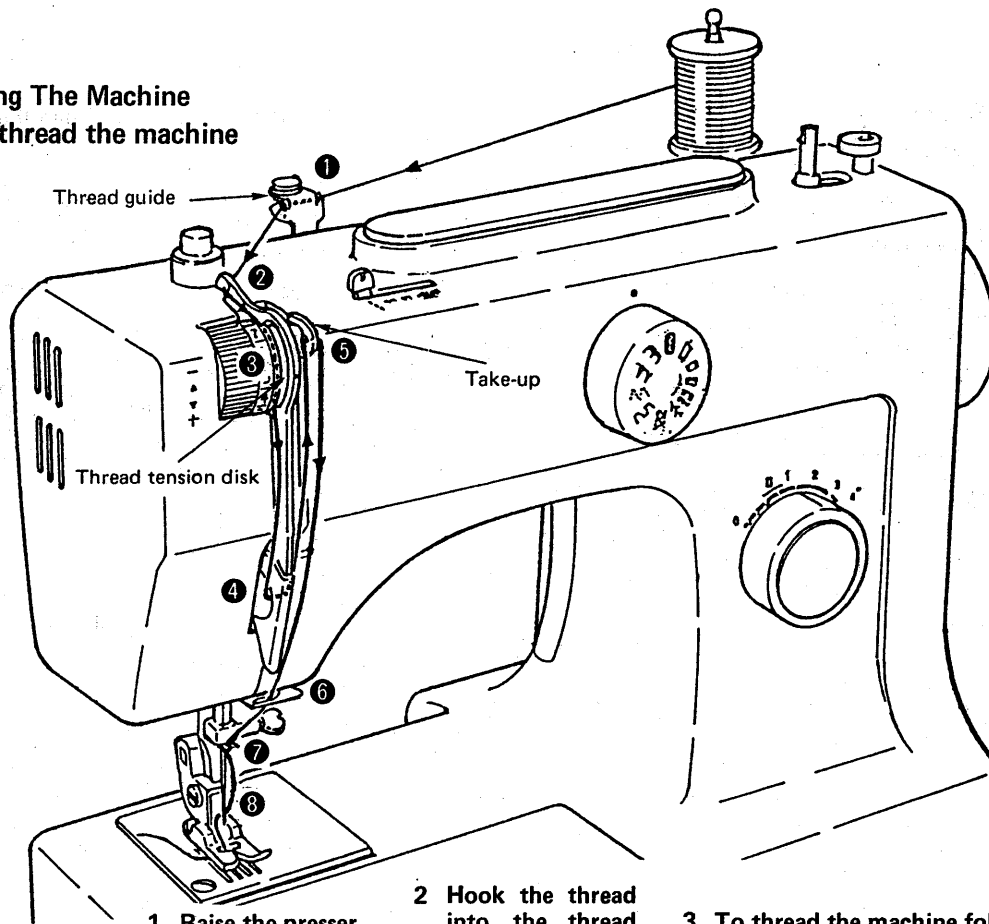

1 Raise the presser foot lever

2 Hook the thread into the thread guide

3 To thread the machine follow steps **2** through **8**.

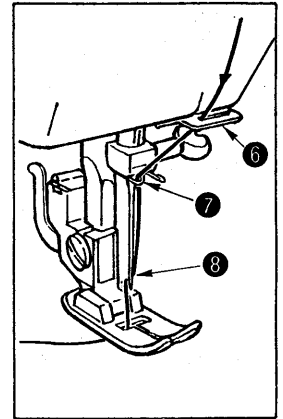
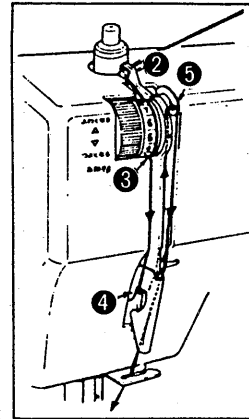
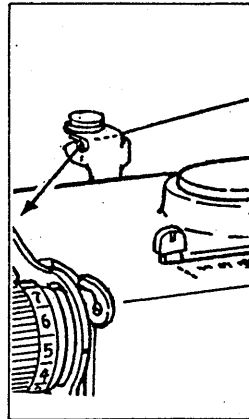
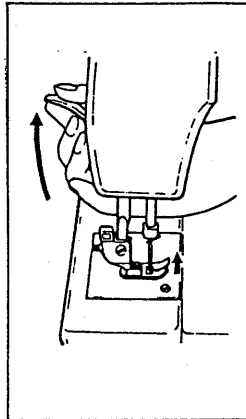

Turn the handwheel, forward to place the take-up in the highest position.

Hook the thread in **6** and **7** from the right.

Pulling Up The Bobbin Thread

1 Hold the needle thread lightly with the left hand and turn the handwheel toward you until the needle enters the needle plate.

2 Drop the bobbin thread and tighten the hold on the needle thread until the bobbin thread is pulled up.

3 Pull both needle and bobbin threads out about 4" and pass them under the presser foot to the back of the machine.

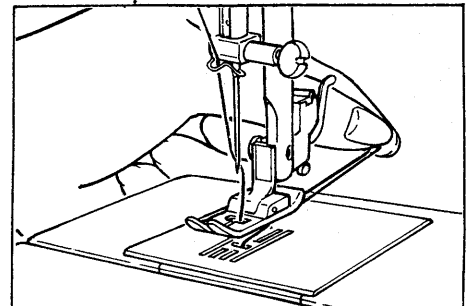
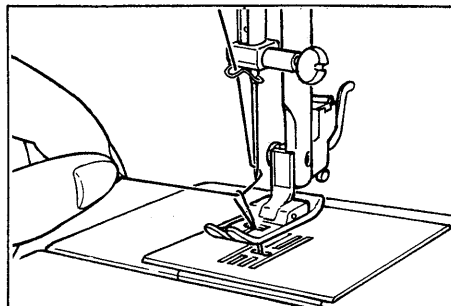
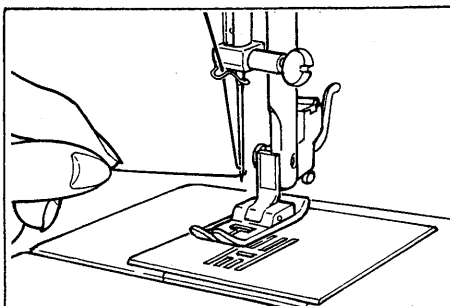

Continue turning the handwheel while holding the needle thread until the needle rises.

Undo the loop with your finger.

■ Changing The Presser Feet

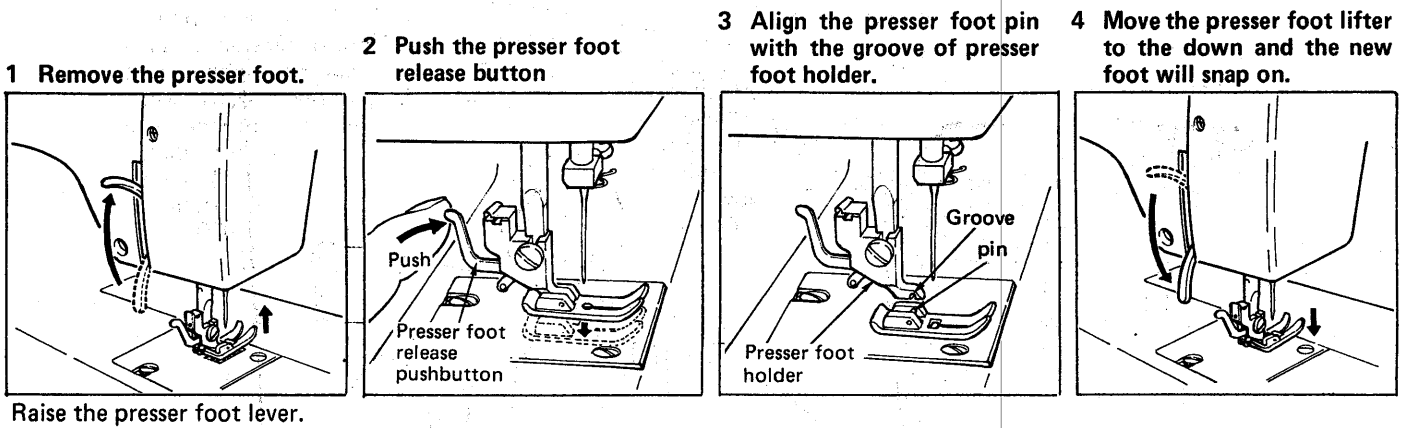

Raise the presser foot lever.

■ How To Remove And Insert The Needle

⚠ CAUTION: Make sure to disconnect the plug from the wall outlet before inserting the needle.

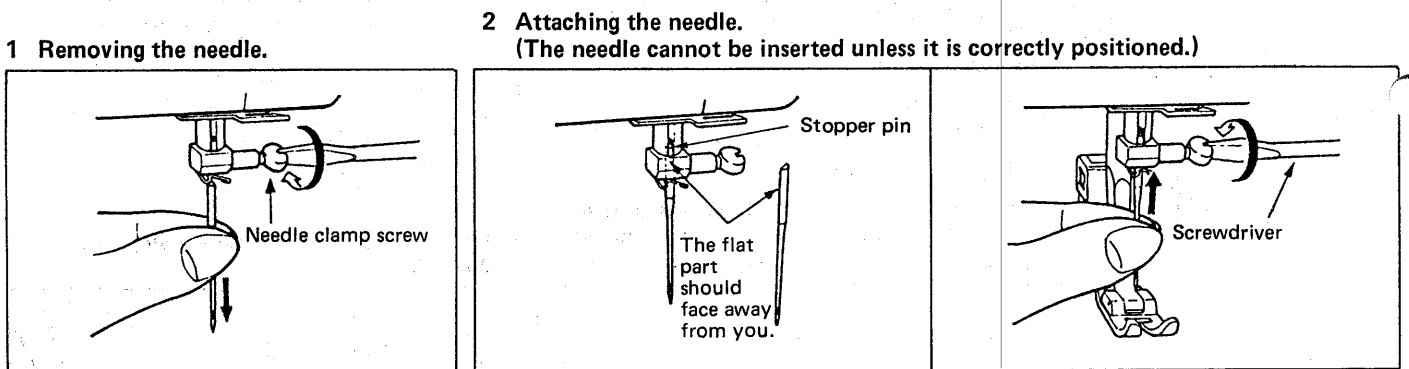

- (1) Turn the handwheel toward you to until the needle bar reaches its highest position.
- (2) Loosen the needle clamp screw.

Hold the needle with its flat part pointing away from you, and insert it fully until it touches the stopper pin.

Securely tighten the needle clamp screw, using the screwdriver furnished with the machine.

● Needles to be purchased

When purchasing spare needles, specify HAX1 for household sewing machine or HAX1KN (knitting needle).

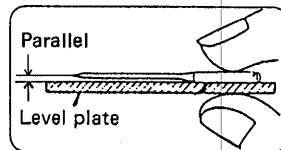
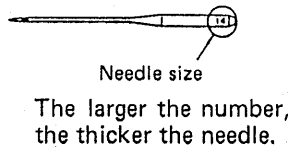

* Check the needle for its straightness occasionally. Any bent needle would cause stitch skipping, thread breakage or damage to materials.

■ Types Of Feet And Their Application

	Straight stitch foot	Zigzag stitch foot							Zipper foot	Overcasting	Blindstitch presser foot	Rolled hemming foot	Buttonhole foot
Feet													
Stitch pattern	--- ≡≡≡	 	 	 	 	 	 	 	---	 		--- (S)	1 24 3
Typical applications	Straight stitch Stretch reinforcing stitch	Zigzag stitch	Overcasting 3-step zigzag stitch	Patchwork, etc.	Scallop stitch	Pattern stitch	Zigzag stretch reinforcing stitch	Setting zipper	Overcasting (Overlocking)	Blindstitch	Rolled hemming	Buttonholing	

■ How To Adjust Thread Tension

Correct the thread tension

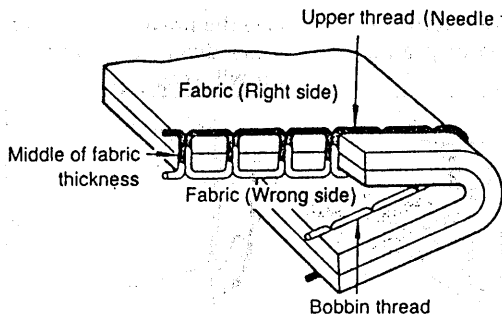

The upper thread and bobbin thread should interlock at the middle of the fabric thickness as shown below.

The upper thread tension is too low.
Upper thread (Needle thread)

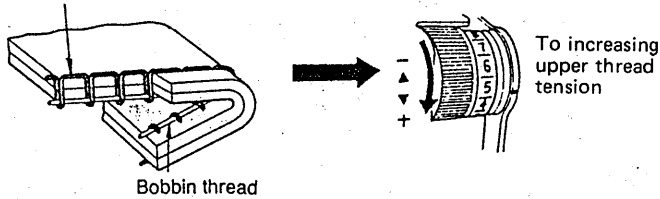

The upper thread tension is too high.

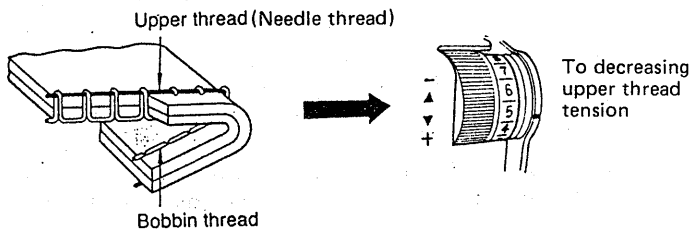

■ How To Adjust The Bobbin Case

The standard bobbin thread tension is such that the bobbin case goes down slowly when you hold the open end of the bobbin thread and shake it as shown at right. (The count of the thread is #50.)

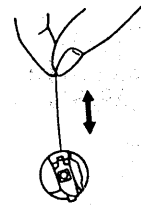

Turn the tension screw of the bobbin case clockwise to increase the bobbin thread tension or counter-clockwise to decrease it.

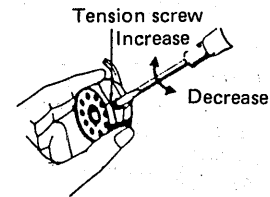

■ Fabric, Thread And Needle Table

Material	Fabric	Thread	Needles	Presser foot adjusting button	Stitch length		Thread tension dial
					Straight	Zigzag	
Lightweight 	Lawn	Silk thread #80~100 Synthetic thread/ Fine thread #90 · 100	(No. 9)	 Low pressure	1~4	1~3	2~4
	Georgette		No.11				
	Tricot	Synthetic #50/60	Knitting needle No.11				
	Wool and synthetic fiber cloth	Silk #50 Synthetic #50/60	No.11				
Medium-weight 	General cotton and synthetic cloth	Cotton #50 ~ 80 Synthetic #50 ~ 60	No.11~14	 Middle pressure	0.5~4	1.5~3	4~6
	Light-weight jersey	Silk #50	Knitting needle No.11				
	General wool and synthetic cloth	Synthetic #50/60	No.11~14				
Heavy-weight 	Denim	Cotton #30 ~ 50 Synthetic #30 ~ 50	No.14~16	 High pressure	0.5~4	2~4	5~7
	Jersey	Silk #50 Synthetic #50 ~ 60	Knitting needle No.11~14				
	Coating	Silk #50	No.11~14				

* The knitting needles (HAX1 KN) effectively prevent stitch skipping, and are ideal for sewing stretchy materials.

■ Straight Stitch

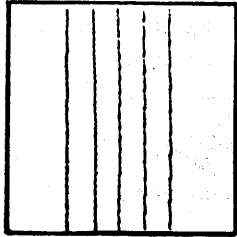

The straight stitch is the basic stitch.

1 Select a stitch pattern.

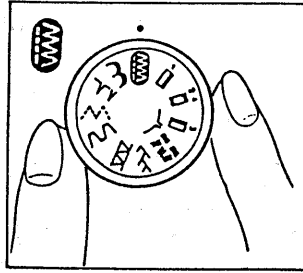

2 Left side stitch width lever

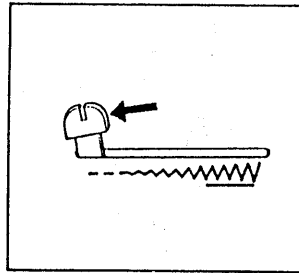

3 Make sure that the presser foot is correct.

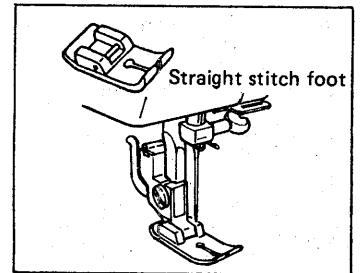

4 Set the material and lower the presser foot.

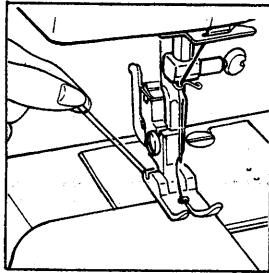

5 Select the stitch length range.

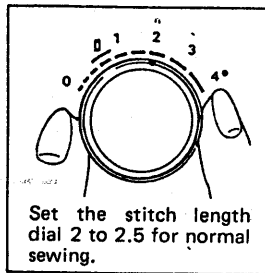

Set the stitch length dial 2 to 2.5 for normal sewing.

6 Begin sewing.

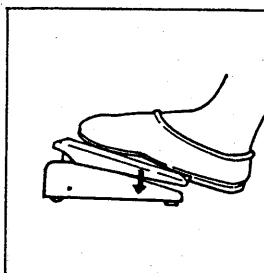

7 Lightly hold the material with your hands.

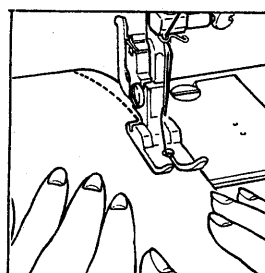

8 Adjust the sewing speed.

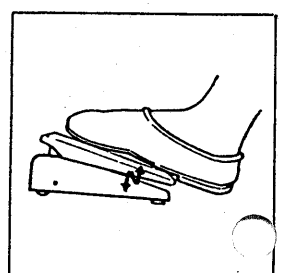

Place the material under the presser foot so the needle will enter the sewing start point of the material. Pull both the upper and bobbin threads to the rear of the machine and lower the presser foot.

Be careful not to apply excessive pulling force to the material while sewing.

9 Stop sewing.

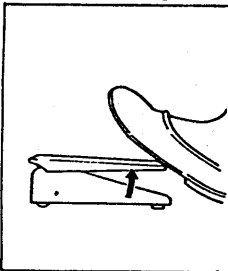

10 Remove the material from the machine.

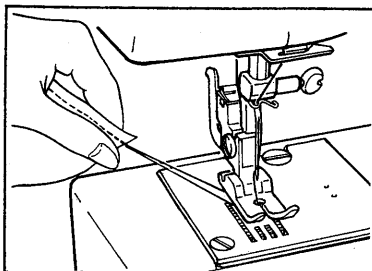

After finishing a seam, raise the needle and the presser foot, and slowly pull the material from under the presser foot.

11 Cut the threads, using the thread cutting groove.

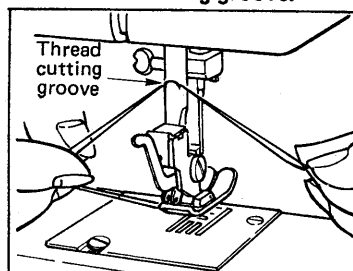

Hold the upper and bobbin threads together, pull them out about 4" and cut them with the thread cutting groove located at the rear of the presser foot.

12 Knot the two threads on the wrong side of the fabric.

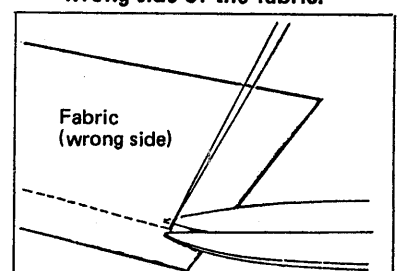

Pull the upper thread to the wrong side of the fabric, and knot the upper and bobbin threads. Cut the threads as close to the knot as possible. This technique is useful for securing the pattern stitches.

■ Reverse Stitch

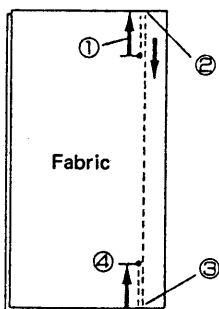

The reverse stitch is used at the beginning and end of a seam to secure it.

① Press the reverse stitch button. Begin sewing.

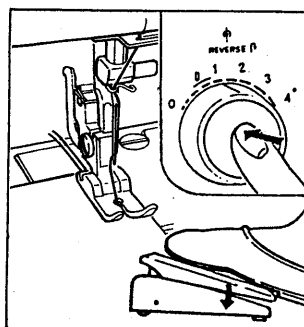

② Detach the finger from the reverse stitch button, sew the straight

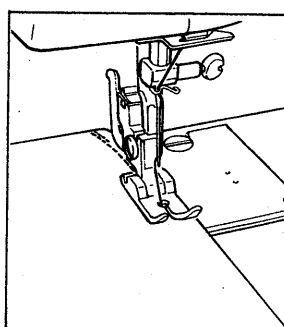

③ Press the reverse stitch button.

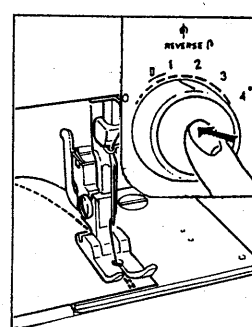

④ Stop sewing.

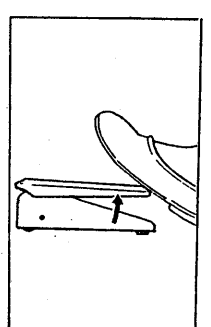

Overcasting

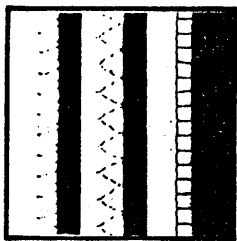

Used to prevent fabric from fraying.

1 Select the stitch pattern.

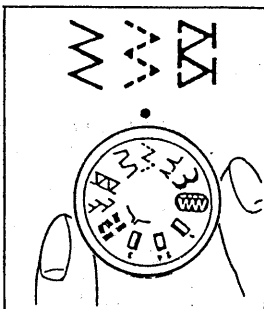

There are three stitch types that can be used for overcasting.

2 Set the stitch length and width.

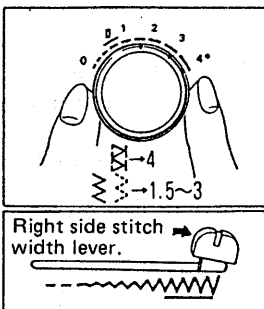

3 Replace the presser foot.

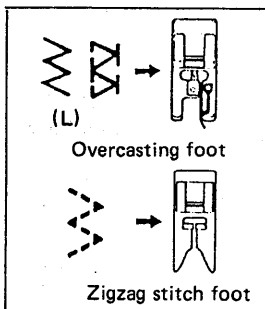

Be sure to use the zigzag presser foot for the stitch width 3 and 3-step zigzag sewing.

4 In case of the overcasting presser foot.

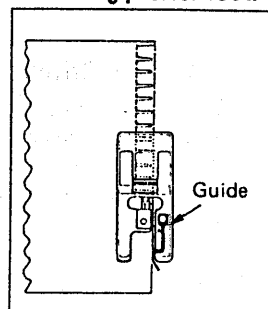

Place the fabric against the foot guide so that the needle sews close to the edge.

Inserting Zippers

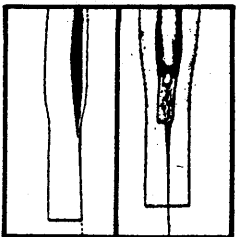

Zippers may be inserted in several ways. The type and location of the zipper will help you choose the right method.

1 Select a stitch pattern, set the stitch length and width.

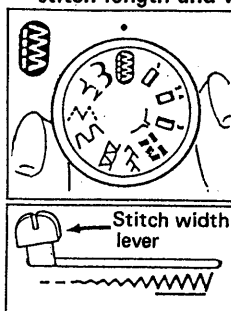

- * Stitch length
- Runstitch 2 ~ 2.5
- Basting stitch 4

2 Change the presser foot.

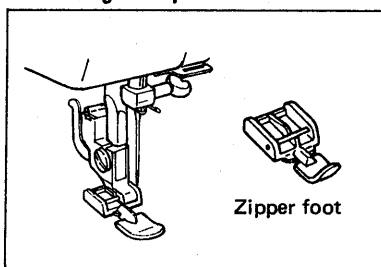

Attach zipper foot to machine. The zipper foot can be used either to the left or right of the needle, depending on where the bulk of the garment is placed.

3

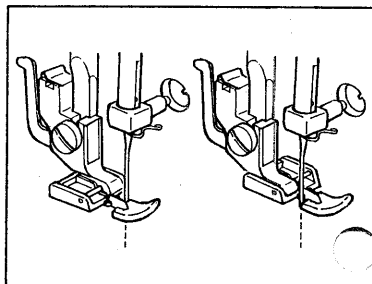

- If the zipper is left of the needle, the left side of the zipper foot goes on the shank.
- If the zipper is right of the needle, the right side of the foot goes on the shank.

Lapped Insertion

1 Lapped: Zippers usually are inserted 2 in the side seam of the garment.

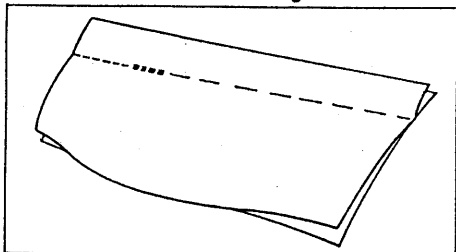

A zipper is lapped when one edge of the fabric opening overlaps and conceals it, allowing only one stitching line to show.

- Machine-baste the zipper opening together on the seamline, and press open the seam allowance.
- Attach the left side of the zipper foot to the shank.

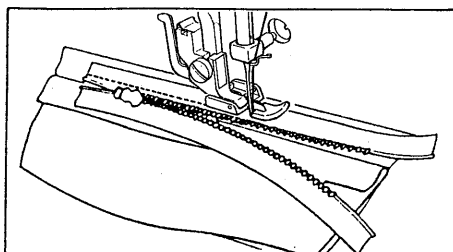

- Open the zipper and flatten the back seam allowance, as shown, with the zipper face down and the edge of the teeth following the seam line. The zipper's top should fall between 1/8" and 3/8" below the garment top seam.
- Stitch the zipper to the seam allowance from bottom to top.

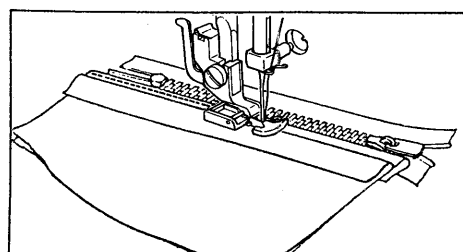

- Attach the right side of the zipper foot to the shank.
- Close the zipper and turn it face up.
- Smooth back the seam allowance at edge of the zipper.
- Stitch the zipper from bottom to top, as shown, near the seam allowance folded edge.

4

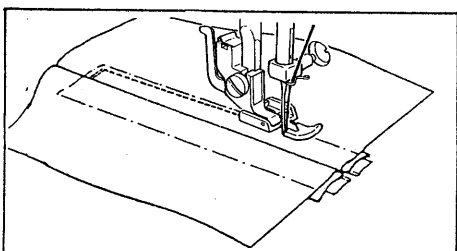

- Pin or machine-baste the zipper to the garment from the wrong side, through zipper tape, the seam allowance, and the front of the garment.
- Turn the garment right side out.
- Attach the left side of the zipper foot to the shank.
- Stitch across the lower end of the zipper and up to the waistline. Use the basting stitches as a guide.
- Remove the basting and press.

Centered Insertion

1 Centered: Zippers are centered in the opening, and are suitable for almost all fabrics.

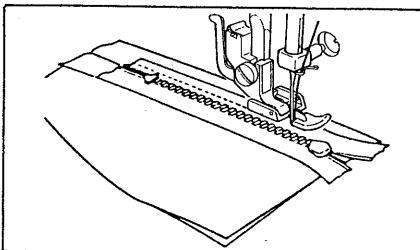

- Machine-baste the zipper opening to the seamline, and press open the seam allowance.
- Place the open zipper face down on the seam allowance with the teeth against the seamline.
- Stitch the zipper to the seam allowance from bottom to top.

2

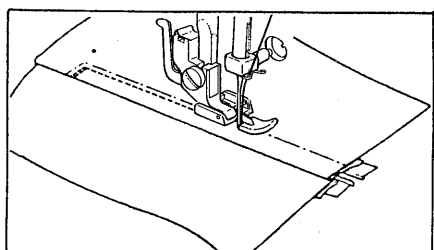

- Baste through the zipper tape, seam allowance and garment exterior.
- Turn the garment right side up and top-stitch it to the zipper, sewing through all layers.
- Remove the basting and press.

■ Stretch Stitch

Stretch stitching reinforces the seam on elastic material or sections that are likely to after overddged.

1 Set the stitch length and width.

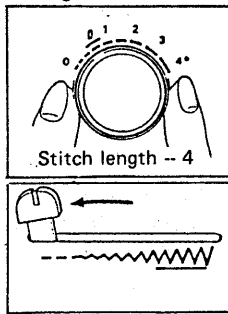

2 Check that the presser foot is the correct one.

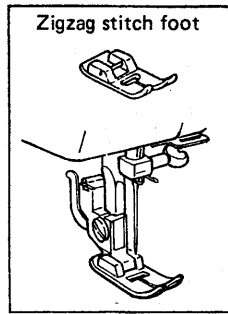

3 Slect the pattern

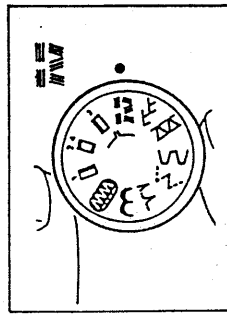

● Application examples

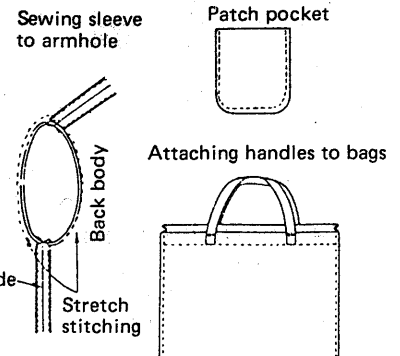

■ Blindstitch

Blind stitching providens a durable way to finish a hem and is presented as an instantly selectable pattern as a convenience. It takes practice, however, so a test sample is suggested.

1 Overcast the material, and fold the edge.

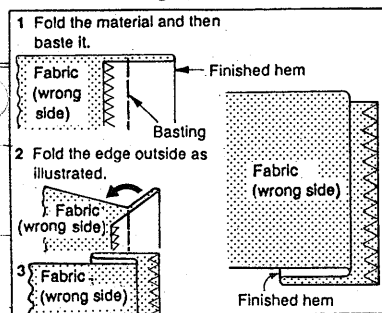

Refer to page 11 for overcasting.

2 Select the blindhem stitch pattern.

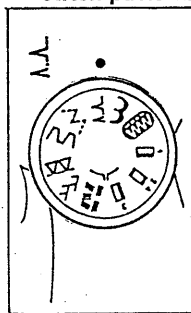

3 Change the presser foot.

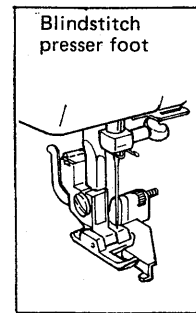

4 Position the folded edge against the guide.

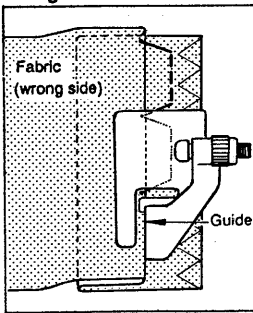

Place the folded edge against the presser foot guide, and sew the material.

5 Turn the fabric over.

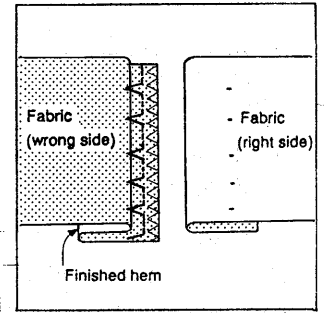

After sewing the seam, turn the fabric over.

* Set the stitch length 2 ~ 4.
* Set the stitch width.

● How to adjust the guide of the blindstitching presser foot

● If the stitches fail to reach the folded edge:

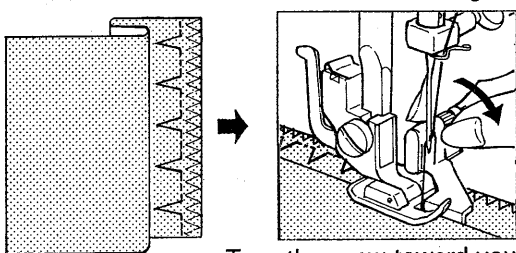

Turn the screw toward you. This will move the guide to the right. Place the folded edge snugly against the repositioned guide.

● If the stitches cover the folded edge too much:

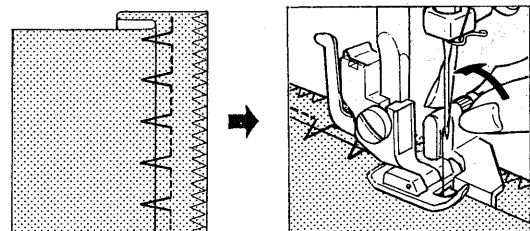

Turn the screw away from you. This will move the guide to the left. Place the folded edge snugly against the repositioned guide.

■ Rolled Hemming

● Attach the rolled hemming foot.

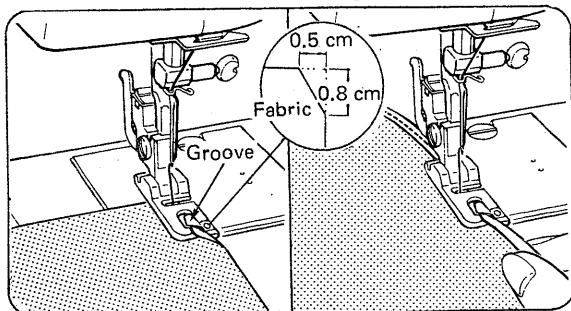

● Select the stitch pattern



Stitching	Stitch length	Stitch width
	2 ~ 2.5	
	2 ~ 2.5	

1. Cut the corners of the material just a bit so that the material is rolled in with ease.
2. Fit the material along the spiral-shaped groove in the hemmer until the material reaches the position within the reach of the needle. Then let the needle enter the material, and lower the presser foot.
3. Draw out the ends of the needle and bobbin threads by your left hand, turn the handwheel by hand, and sew the material taking care that the appropriate amount of the threads are fed with consistency.

■ Patch Work

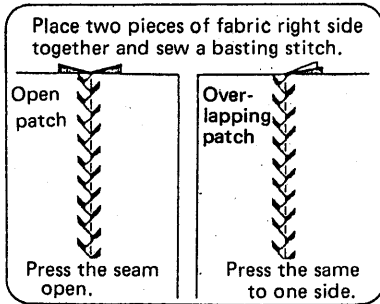

Sew a pattern stitch on top of the seam.

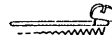
- Select the stitch pattern 
- Stitch length 4
- Stitch width 
- Attach the zigzag stitch foot.

■ How To Use The Ruler For Quilting

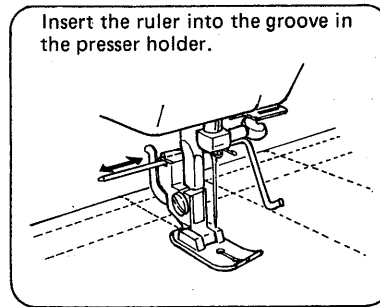

Quilt the material tracing the seam previously sewn with the ruler.

■ Maintenance Of The Sewing Machine (Cleaning and lubrication)

CAUTION: Be sure to disconnect the plug from the wall outlet before cleaning and lubricating the machine.

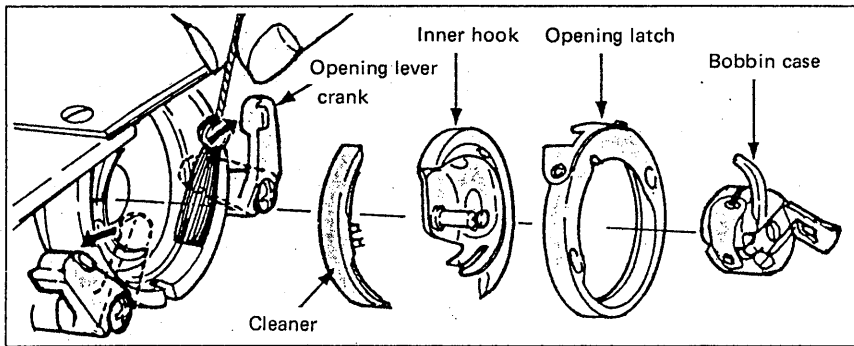

- * When assembling, follow the procedure for disassembling the hook in the reverse order.
- * Close the bobbin case opening lever crank until it clicks.

If thread waste or dust accumulates in the hook, disassemble the hook and clean it.

1. Raise the needle bar until its highest position is reached, open the hook cover and take out the bobbin case from the hook.
2. Open the bobbin case opening lever crank, and remove the bobbin case opening latch.
3. Take out the inner hook.
4. Clean up inside the shuttle race using a brush. Then apply a few drops of lubricating oil onto the shuttle race.

Removing the lint and dust

Accumulation of lint or dust may cause problems. Always keep your sewing machine clean.

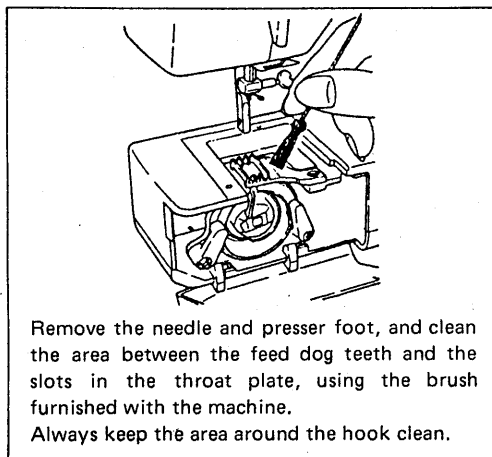

CAUTION: Contact the dealer in your area for the correct light bulb replacement.

■ How To Remove The Face Cover

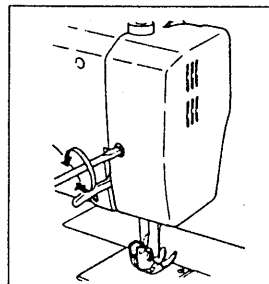

Using the screwdriver, remove the setscrew and pull the cover off sideways.

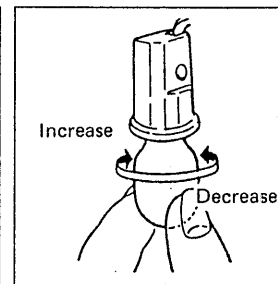

The power consumption of the light is 15 watts.

■ List of Stitching, Stitch Pattern, Width, Length and Presser Foot

	Stitching	Select the stitch pattern	Set the stitch width	Set the stitch length	Presser foot
1	Straight stitching				 Straight stitch foot
2	Zigzag stitching			 LENGTH REVERSE (P) 0 1 2 3 4	 Zigzag stitch foot
3	Full auto zigzag			「0.5 ~ 4」	
4	Super auto zigzag		 LENGTH REVERSE (P) 0 1 2 3 4		
5	Stretch stitching			「4」	
6	Buttonholes stitching			 LENGTH REVERSE (P) 0 1 2 3 4 「0.5 ~ 1」	 Buttonhole foot

■ Lubricating The Machine

Be sure to only use sewing machine oil on the machine.

If the machine is operated for an extended period of time or if it has not been used for a long time, lubricate the points indicated by the arrows shown below.

Scene of open the face cover

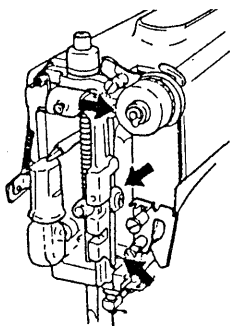

Scene of open the back cover

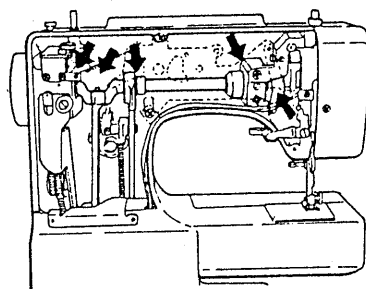

Scene of open the bottom cover

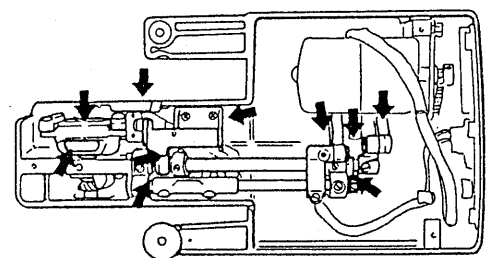

■ Performance Checklist

If sewing difficulties occur, make sure the instructions are correctly followed.
If a problem still exists, the reminders below may help solve it.

Problem	Cause (Reason)	Action to be taken	Page
The machine does not feed the material.	* The fabric feed push up side .	* Push the down side of fabric feed.	4
	* The machine runs idle.	* Tighten the stop-motion screw.	5
	* The stitch length has been set to zero.	* Set the stitch length "1 ~ 4".	8
	* The presser foot pressure is too low.	* Increase the pressure of the presser foot.	8
The needle breaks.	* The needle has been inserted wrong.	* Properly insert the needle.	7
	* The needle is bent or is blunt.	* Replace the needle with a new one.	7
	* The presser foot is not the correct one.	* Use the correct presser foot.	7
	* The needle and the threads do not match.	* Use proper thread or needle.	8
The thread breaks.	* Threading is not correct.	* Correctly thread the machine.	6
	* The thread has a knot in it.	* Remove the knot.	6
	* The thread tension is not correct.	* Correct the thread tension.	7
	* The needle is bent.	* Replace the needle.	7
The bobbin thread breaks. Skipped stitches.	* The bobbin thread tension is too high.	* Correctly adjust the bobbin case.	8
	* The needle has been inserted wrong.	* Properly insert the needle.	7
	* The needle is bent.	* Replace the needle.	7
	* Threading is not correct.	* Correctly thread the machine.	6
Loud noise is heard.	* The machine is in need of lubrication after an extended operation.	* Lubricate the machine.	13
	* Dust has accumulated on the feed dog.	* Clean the machine.	13
Fabric puckers.	* The thread tension is too high.	* Correct the needle and the bobbin thread tension.	8
	* The material, the needle and the threads do not match.	* Use the correct size needle and the thread.	8
	* The presser foot pressure is too high.	* Decrease the pressure of the presser foot.	8

JUKI®

JUKI CORPORATION

8-2-1, KOKURYO-CHO,
CHOFU-SHI, TOKYO 182, JAPAN
PHONE : 03(3480)5034
FAX : 03(3480)5037