

JUKI®

INSTRUCTION BOOK

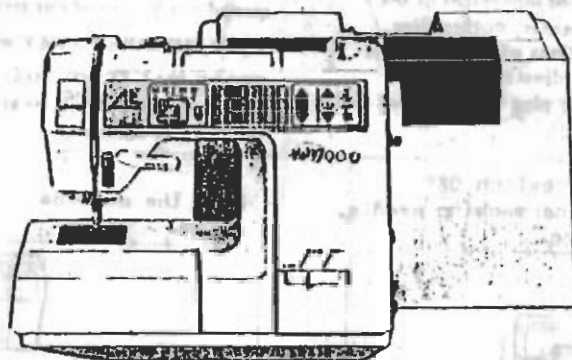

COMPUTER SEWING MACHINE

AUTO TENSION
Model 7000

CONTENTS

SAFETY REGULATIONS	1	VARIOUS TYPES OF STITCHES	14
HOW TO REMOVE THE COVER - ACCESSORIES	2	STRAIGHT STITCH	15-16-17
NAMES OF PARTS	3	*Reverse stitch	16
CONVERTING THE FLAT BED TO FREE ARM	3	*Changing the stitching direction	16
MAJOR FUNCTIONS	4	*Sewing start for heavy-weight material	16
PREPARING THE LOWER THREAD	5-6	*Sewing overlapping seam allowances	16
THREADING THE MACHINE HEAD	7	*Shirring and gathering	17
*Automatic needle threading	8	*How to operate the automatic thread trimmer	17
*Pulling up the lower thread	8	*How to use the thread trimming groove	17
REPLACING THE PRESSER FOOT	9	ZIGZAG STITCH	18
TYPES OF PRESSER FEET AND THEIR APPLICATIONS	9	AUTOMATIC BUTTONHOLING	19-20-21
STITCH LENGTH OF EACH STITCH PATTERN	10	*Sewing buttonholes with gimps	21
HOW TO ADJUST THE STITCH LENGTH	10	FREE ARM (TUBULAR) STITCH	21
AUTOMATIC THREAD TENSION CONTROL	11	OVERCASTING (OVEREDGING)	22
HELPFUL MONITORS	12	FITTING ZIPPERS	23-24
HOW TO SELECT NEEDLE AND THREAD SUITED TO THE MATERIAL	13	BLINDSTITCH	25-26
HOW TO ATTACH/DETACH THE NEEDLE	13	HOW TO USE THE CONTROL PEDAL	27
		HOW TO REMOVE THE FACE COVER	27
		CLEANING AND LUBRICATING THE MACHINE	28
		HOW TO ADJUST THE BOBBIN CASE	28
		BEFORE CALLING FOR SERVICE	29-30

IMPORTANT: READ ALL SAFETY REGULATIONS CAREFULLY AND UNDERSTAND THEM BEFORE USING YOUR SEWING MACHINE. RETAIN THIS INSTRUCTION BOOK FOR FUTURE REFERENCE.

IMPORTANT

SAFETY REGULATIONS

The following safety regulations must be observed without fail:

1 RISK OF INJURY TO FINGERS:

- The moving needle is dangerous (risk of injury to fingers). The sewing position must therefore be kept under constant observation.
- Manipulations within the area of movement of the needle, such as changing the needle, or threading the machine and all manipulations with open covers (stitch width or stitch length adjustments), must be pulled out the machine plug from the wall outlet.

2 RISK OF ELECTRIC SHOCK:

- When cleaning or lubricating the machine and interruptions in sewing or after completion of work, the machine must be disconnected from the power supply by pulling out the main plug.
- Repairs to the electric section, especially the changing of the lead wire to the foot control unit, may only be carried out by one of our service agencies.
- KEEP CHILDREN AWAY when in use.
- STORE IDLE SEWING MACHINE. When not in use, sewing machine should be stored in dry place-out of the reach of children.

Be sure to turn the power switch OFF before replacing the sewing machine needle, or lubricating the machine.

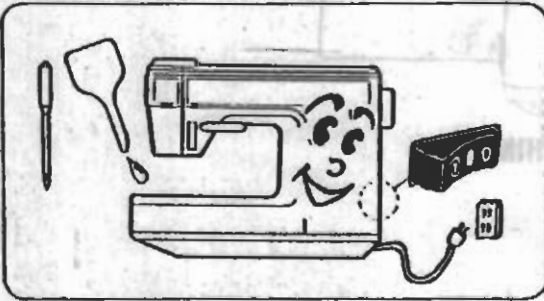

Keep the machine out of children's reach.

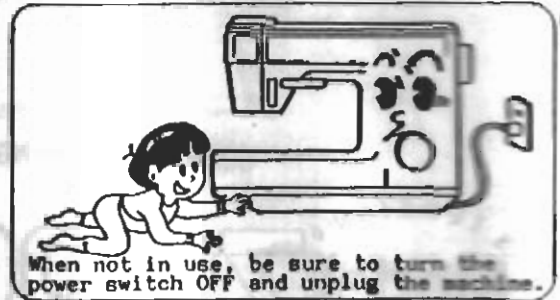

When not in use, be sure to turn the power switch OFF and unplug the machine.

Do not use thinner or other similar solvents to clean the machine.

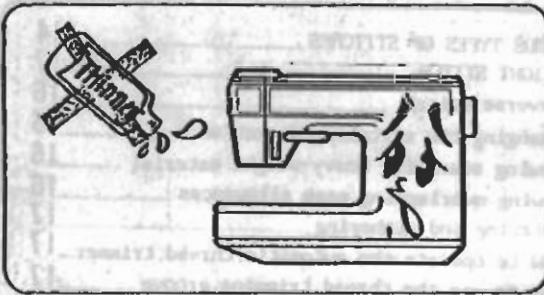

Do not expose the machine to direct sunlight or humid atmosphere.

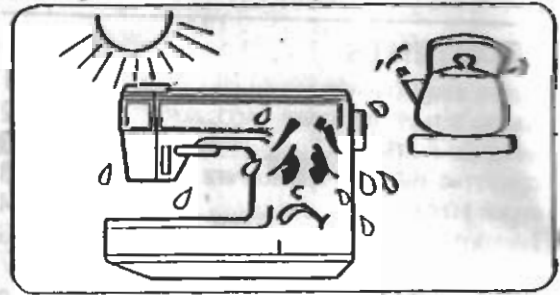

This sewing machine uses a micro computer and precision electronic circuits consisting of semiconductor components, so please observe the following precaution:

- Keep the ambient temperature to 5°C to 40°C. If the temperature of the room where the machine is used is too low, the machine may present problems such as failure to reach its normal sewing speed.
- The motor incorporated in this sewing machine is electronically controlled from low- to high-speed revolution. When the machine is operated for an extended period of time at low sewing speed, the safety device will be automatically actuated to turn off the motor power, thereby preventing motor overheat. If the motor should stop while sewing, turn the power switch OFF, and wait for about 20 minutes. This will reset the safety device, making the machine ready for restart.

HOW TO REMOVE THE CASE • ACCESSORIES

Accessory box built in the cover

How to remove the cover

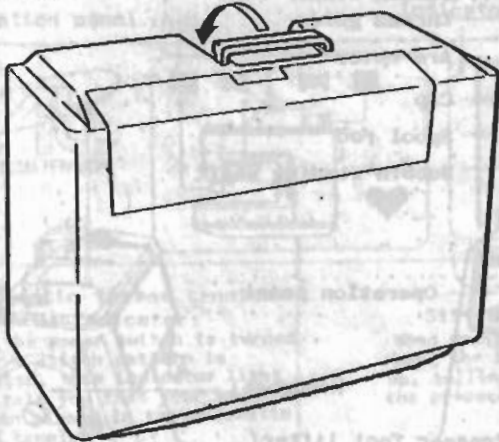

Set the handle down, and lift the cover.

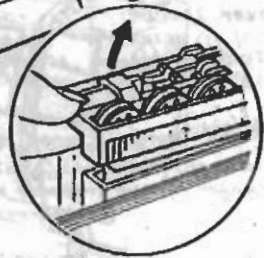
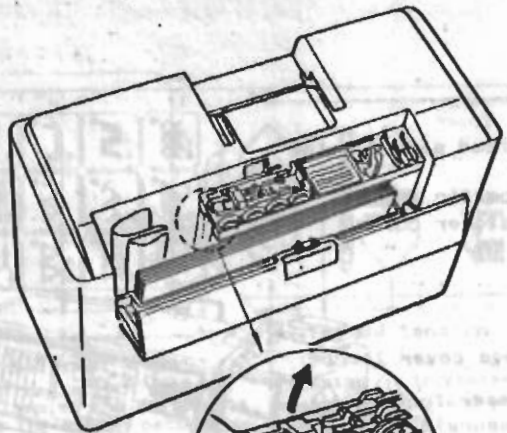

Take out the accessory box as illustrated above. (Small goods can be contained under the accessory box.)

Accessories



The needle case can be removed by pushing the part shown by the arrow.

Quilter



Standard presser foot



The sewing machine is shipped from the factory with this presser foot attached.

Needle case
No. 11(2) No. 14(1)
Knit needle No. 11(2)
(total 5 needles)

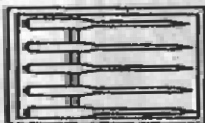

Zipper sewing presser foot



Overcasting presser foot



Bobbins (4)

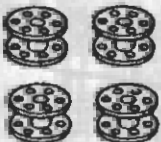

Blindstitch presser foot



Buttonholing presser foot

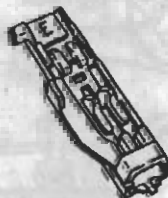

Seam ripper

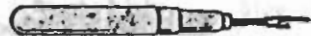

Cleaning brush



Cap (large)



Exclusive screwdriver



Oiler



Thread spools (2)



Tape measure



Be sure to keep this Instruction Book in the machine cover.

NAME OF PARTS • CONVERTING THE FLAT BED TO FREE ARM

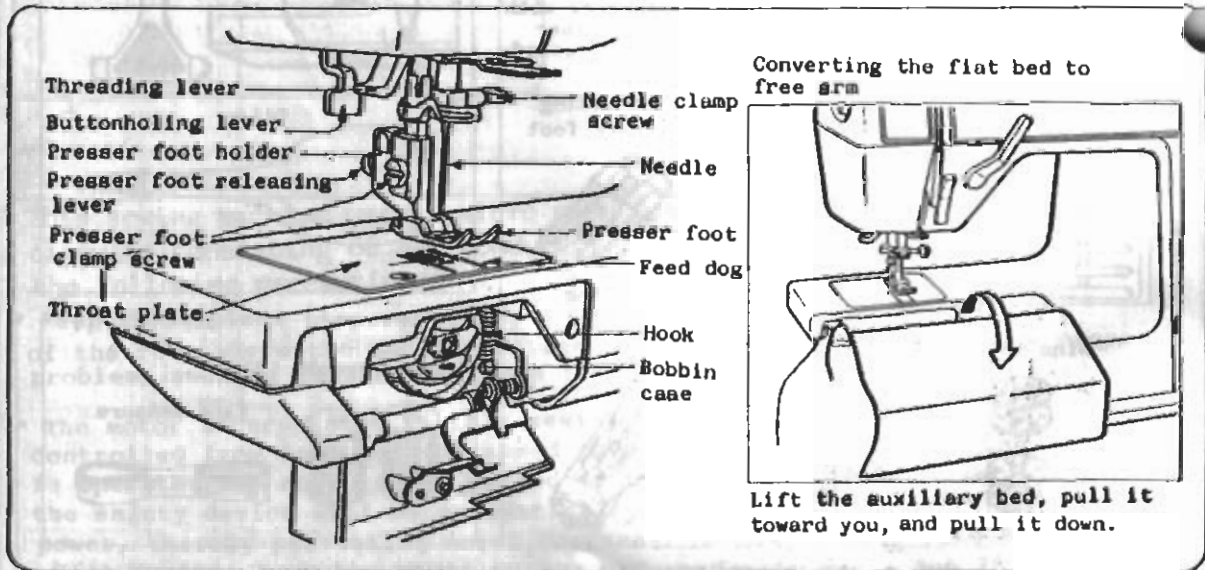
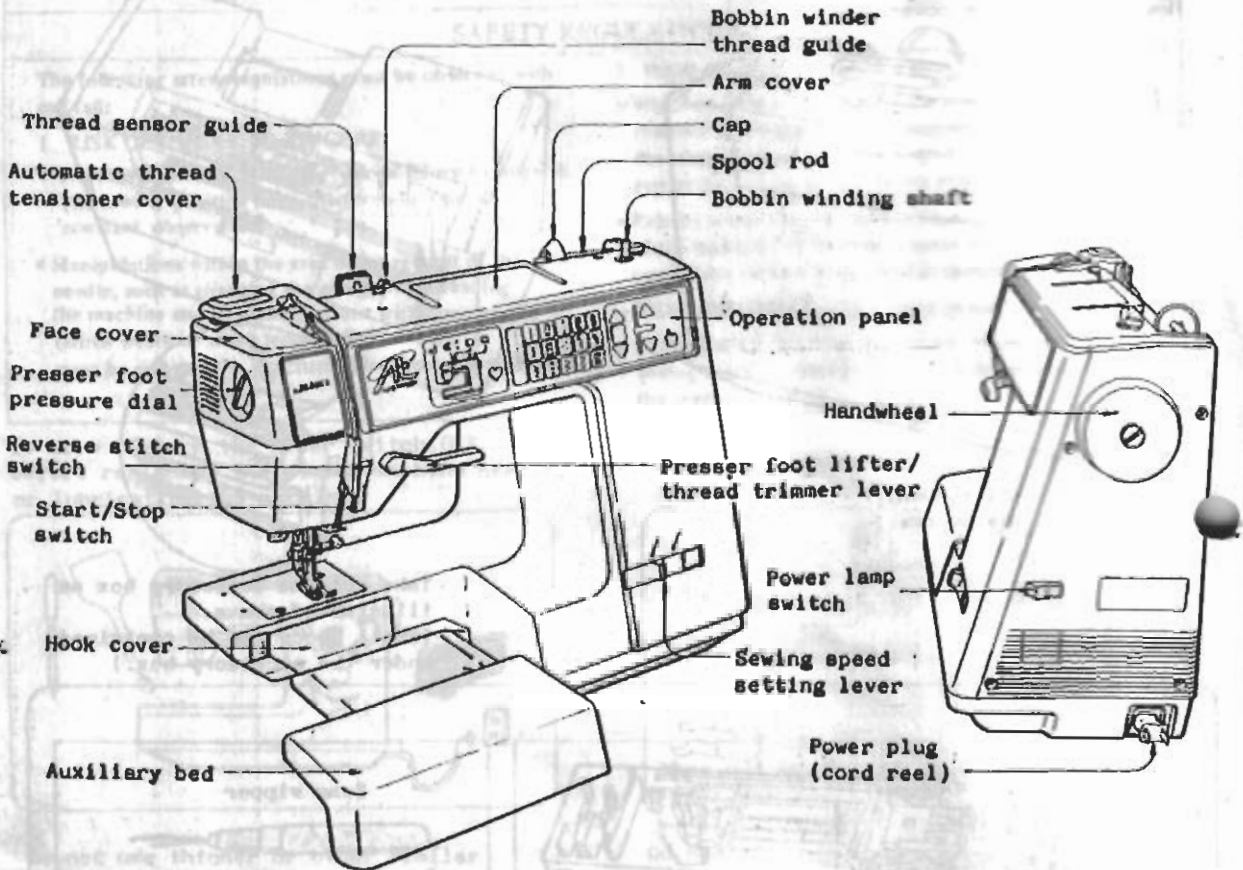

MAJOR FUNCTIONS

Operation panel

Indicator lamp

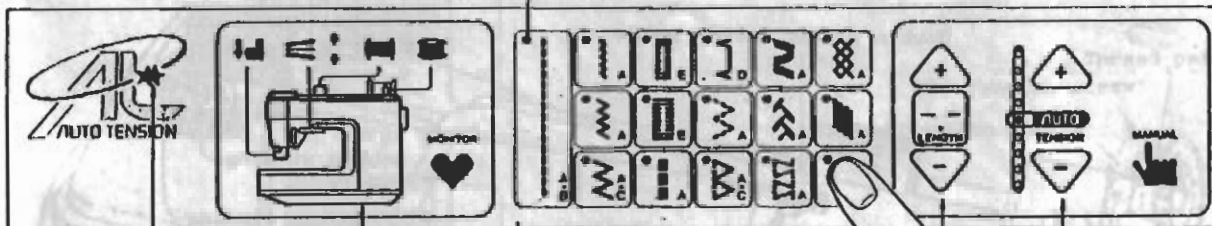

Automatic thread tension control indicator:
When the power switch is turned ON or a stitch pattern is selected, this indicator light up to tell you that your machine has been placed in the automatic thread tension control mode.

Helpful monitors:

One or more of these monitors light up to tell you the error or errors at the time of sewing start, if any.

Stitch pattern selector keys:

When you press a desired stitch pattern key, the indicator lamp of the key lights up, telling you that the stitch pattern on the pressed key has been selected.

Thread tension manual keys:

Pressing Δ increases the stitch length, and pressing ∇ decreases it.

Stitch length manual keys:

Pressing Δ increases the upper thread tension, and pressing ∇ decreases it.

Power cord reel

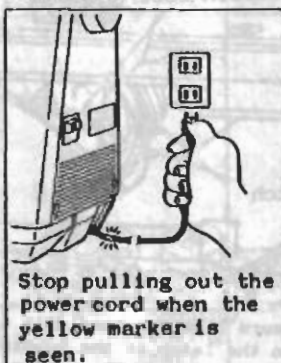

Stop pulling out the power cord when the yellow marker is seen.

Pull out the power cord. You can wind the power cord back onto the reel built in the machine by pulling the cord toward you once before releasing it.

Power/lamp switch

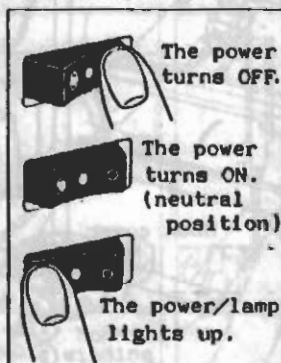

The power turns OFF.

The power turns ON. (neutral position)

The power/lamp lights up.

Presser foot lifter/Thread trimming lever

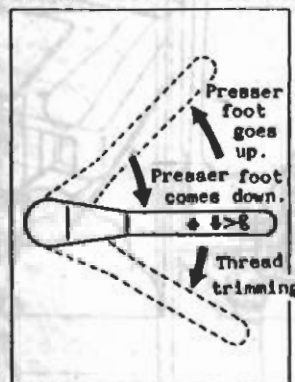

Presser foot goes up.

Presser foot comes down.

Thread trimming

When you push up the lever, the presser foot goes up, when you push it down, the thread trimmer is actuated.

Sewing speed setting lever

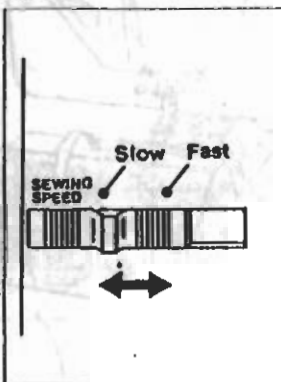

Use this sliding lever to set the desired sewing speed.

Start/Stop switch

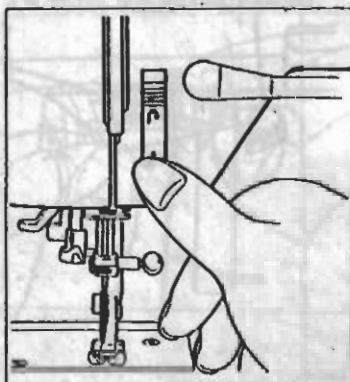

One press on the switch starts the sewing machine, and another press on the switch stops the sewing machine.

Reverse stitch switch

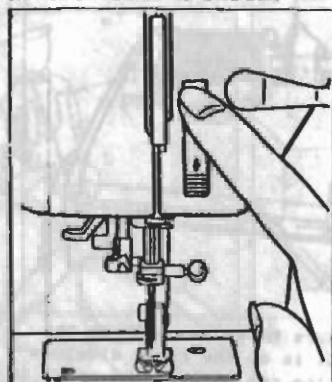

The reverse stitch is engaged only while you keep pressing this switch.

Presser foot pressure dial

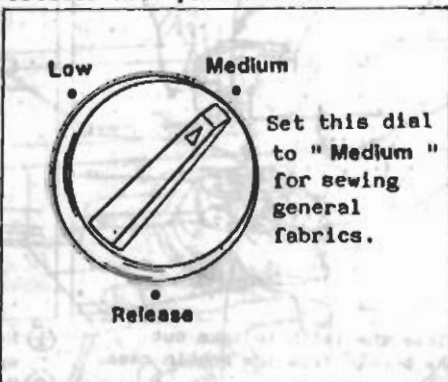

Set this dial to "Medium" for sewing general fabrics.

This dial is used to adjust the pressure of the presser foot according to the type of thickness of the material to sew.

4 PREPARING THE LOWER THREAD

*Threading for winding the bobbin

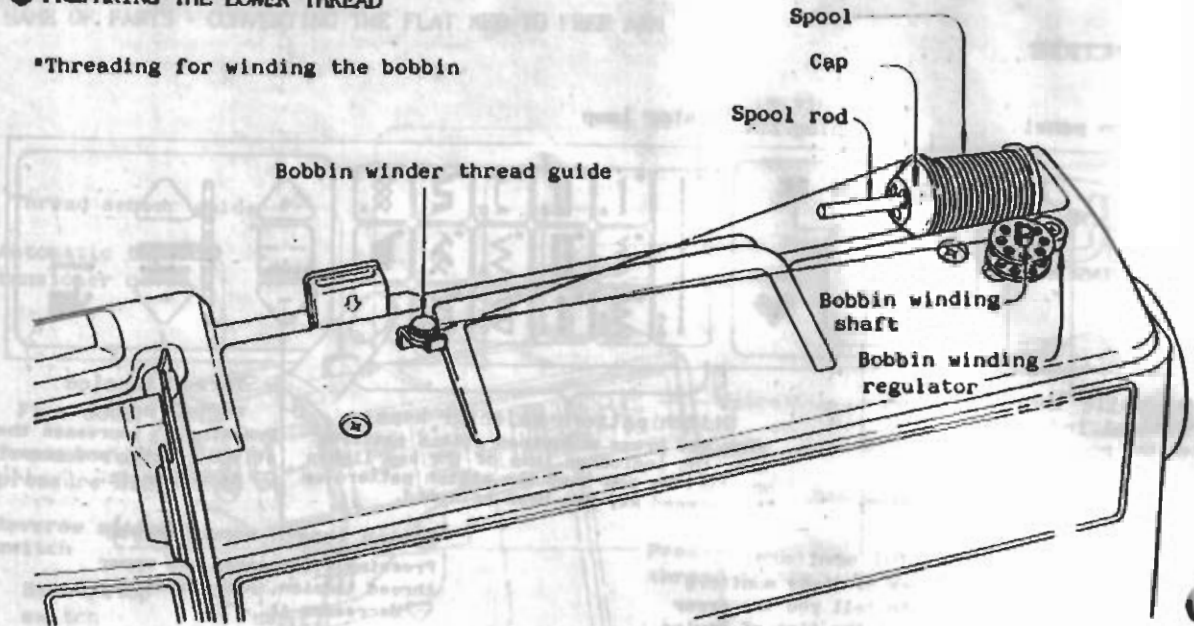

1 Convert the flat bed to free arm.

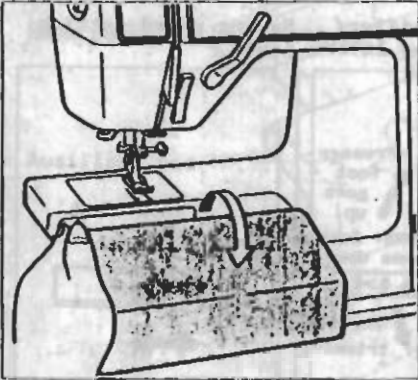

2 Open the hook cover

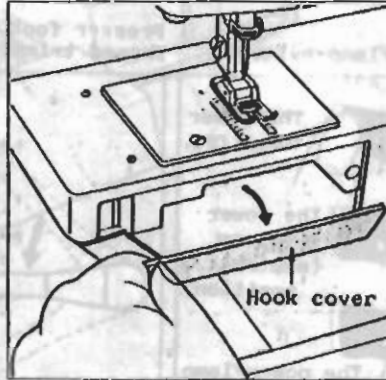

3 Take out the bobbin case.

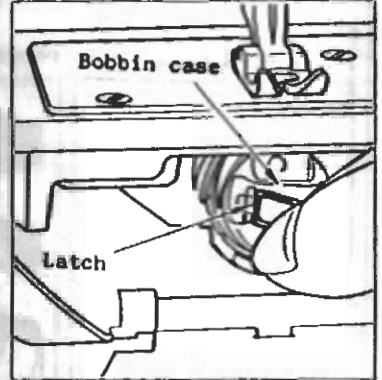

- ① Be sure that the needle is up.
- ② Open the latch of the bobbin case, and remove the bobbin case.

4 Remove the bobbin from the bobbin case.

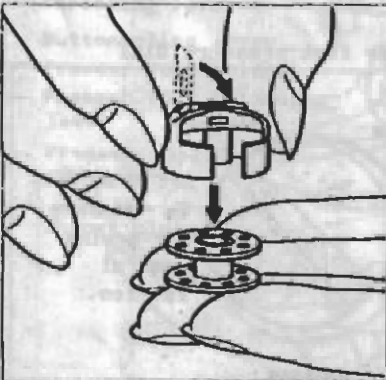

5 Place the spool onto the spool rod.

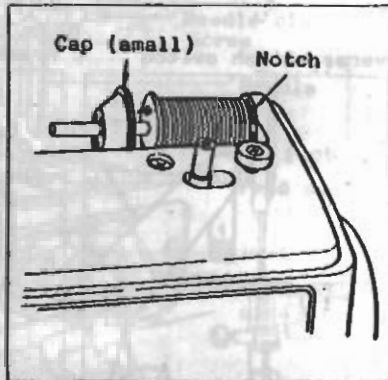

6 Hook the thread onto the bobbin winder thread guide.

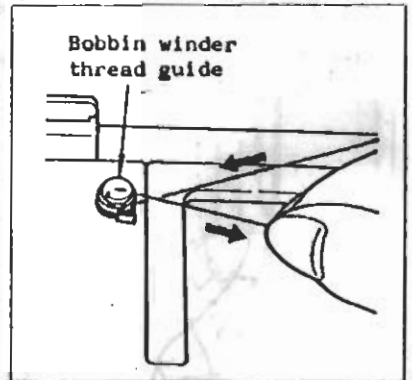

Close the latch to take out the bobbin from the bobbin case.

- ① Be sure that the notch on the spool is on the right side.
- ② Use the cap to hold the spool in place.
- ③ Refer to the following instructions for the proper use of the large and small caps.

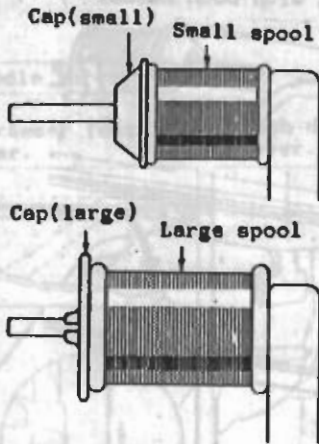

Use the small cap for a small spool, and the large cap for a large spool.

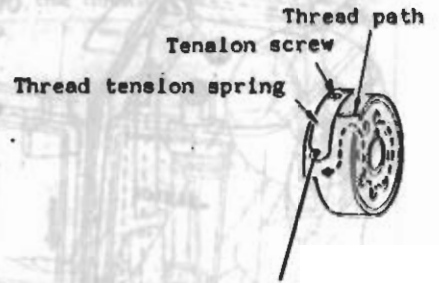

*The bobbin case furnished with the machine is factory-adjusted to provide the proper thread tension, so do not tamper with the tension screw.

7 Attach the bobbin to the bobbin winding shaft.

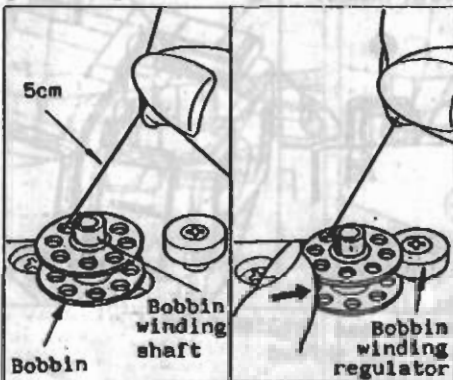

Press the bobbin against the bobbin winding regulator.

8 Press the start/stop switch 9 Push the bobbin back to the left

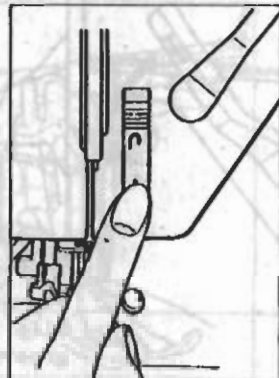

When the bobbin has been wound up, press the start/stop switch again to stop the machine.

* The bobbin winding speed can be adjusted by the sewing speed setting lever.

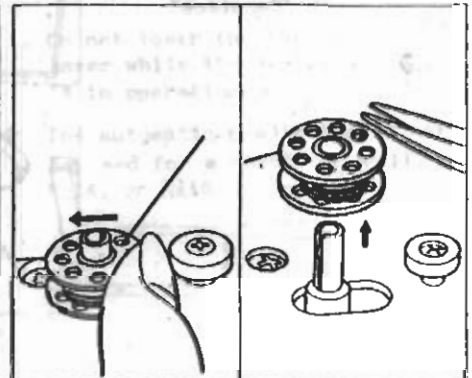

Cut the thread and take the bobbin off the shaft.

10 Set the wound bobbin into the bobbin case

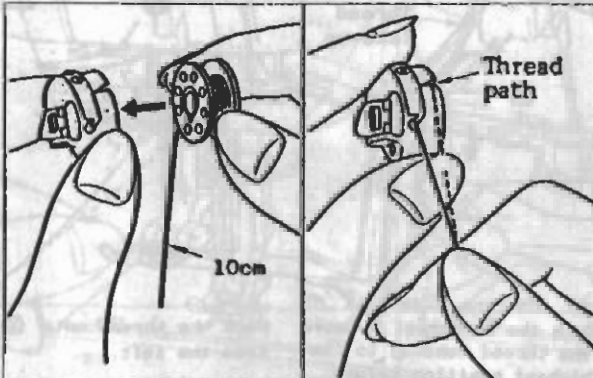

Pass the thread out through the thread path.

11 Reinstall the bobbin case to the machine.

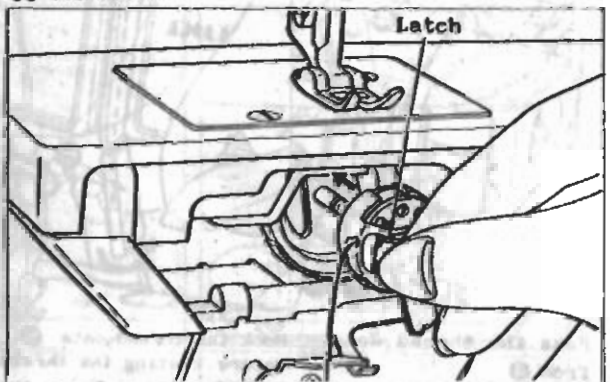

① Fully open the latch, and securely fit the bobbin case into the hook.

② Snap close the latch of the bobbin case.

● THREADING THE MACHINE HEAD

How to thread the machine head

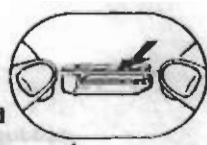

Push the thread into the groove of the thread sensor guide, holding the thread with both hands.

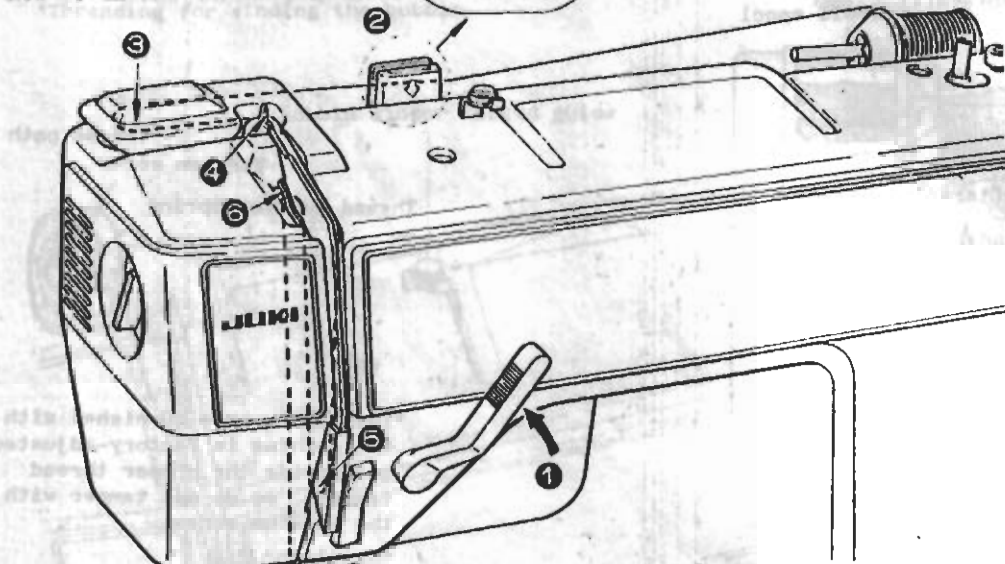

1 Raise the presser foot lifting lever.

2 Pass the thread in the order illustrated. 3

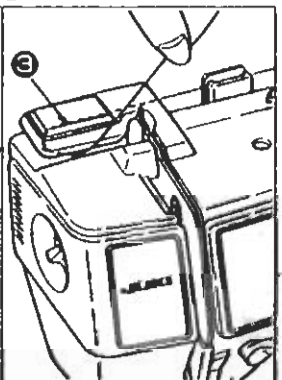
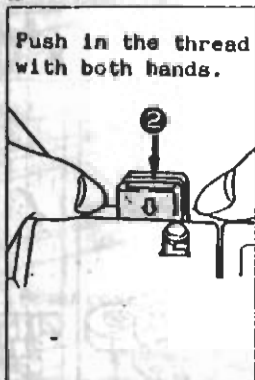
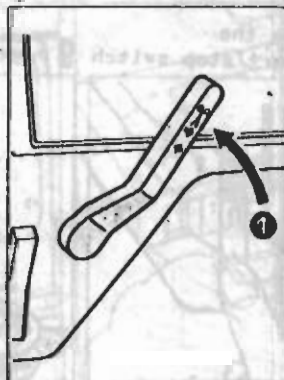

Slip the thread into the groove of the thread sensor guide.

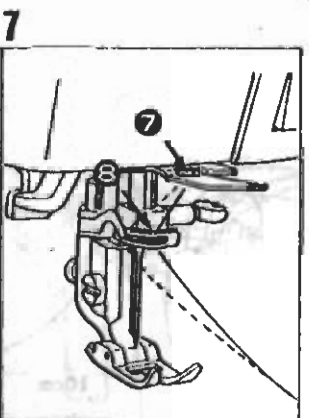
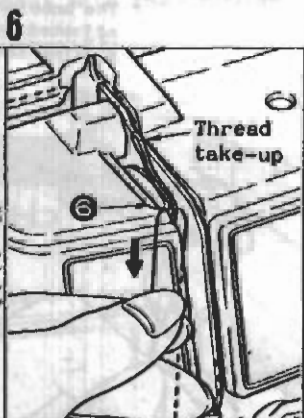
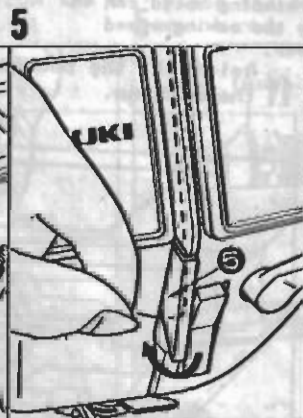
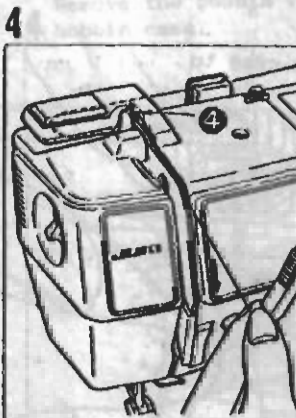

4 Pass the thread down from 4

5 Hook the thread onto 5 before routing the thread upward.

6 Turn the handwheel to move the thread take-up to its highest position before passing the thread through the hole in the thread take-up.

7 Hook the thread onto 7 from the left.

Automatic needle threading

8 Lower the presser foot lifting lever.

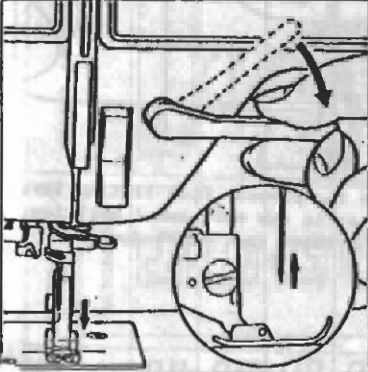

The needle should be in the highest position of its stroke.

9 Push down the threading lever.

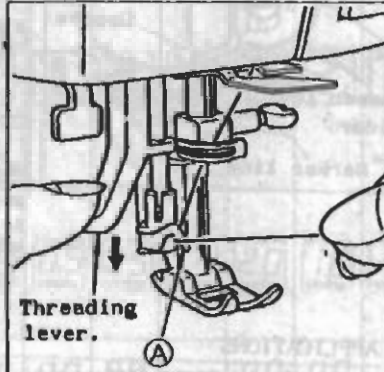

Lower the threading lever halfway (immediately before resistance is felt), and hook the thread onto (A).

10 Pass the thread through the hook.

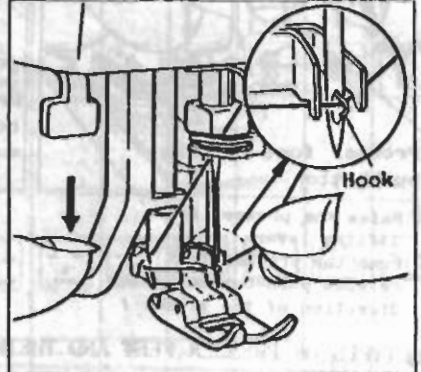

Further lower the threading lever to make the thread pass through the hook.

- This hook functions to pass the thread through the needle eye.

11 Raise the threading lever.

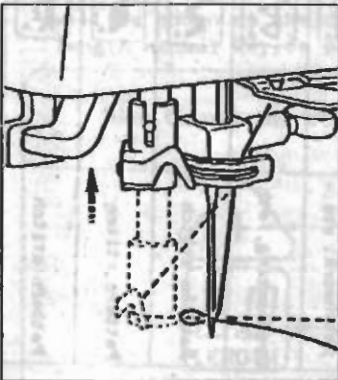

12 Pull out the thread.

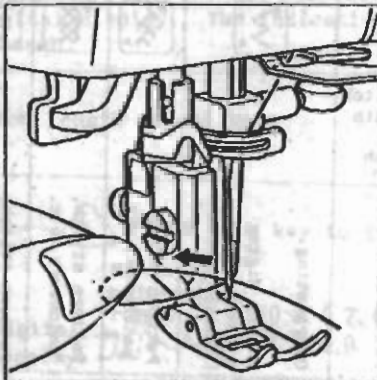

Pull out the thread about 10cm from the needle eye.

Cautions

1. Do not lower the threading lever while the sewing machine is in operation.
2. The automatic needle thread may be used for a needle of No.11, No.14, or No.16.

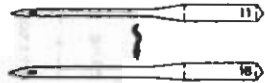

Pulling up the lower thread

13 Lightly hold the upper thread.

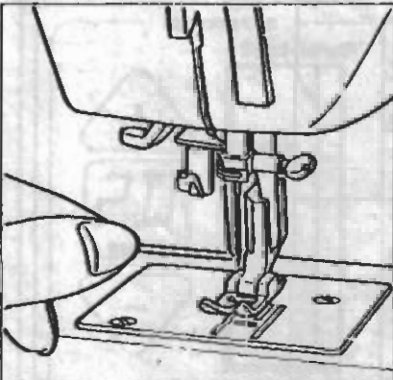

14 Turn the handwheel toward you.

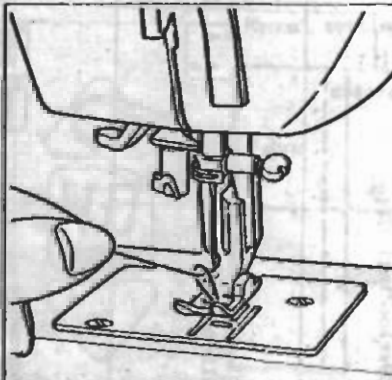

The needle goes down, then comes up with the lower thread.

15 Pull both upper and lower threads out about 10cm.

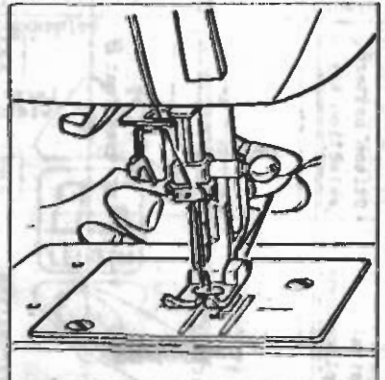

Pass the upper and lower threads under the presser foot and further to the rear of the presser foot.

REPLACING THE PRESSER FOOT

1 Remove the presser foot.

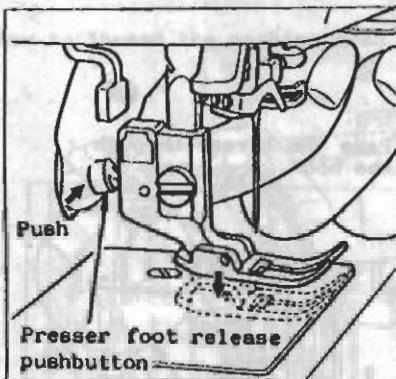

- ① Raise the presser foot lifting lever.
- ② Push the presser foot release push-button in the direction of the arrow.

2 Align the presser foot pin with the marker line.

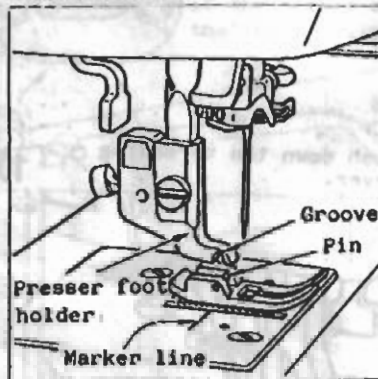

3 Move the presser foot lifting lever down to the horizontal position.

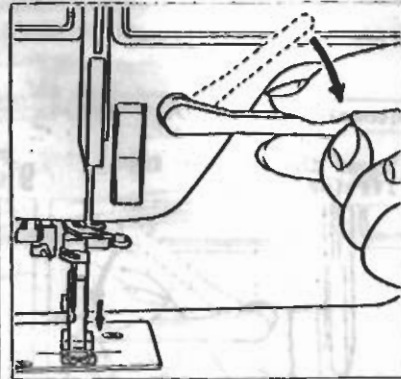

When the presser foot lifting lever is set to the horizontal position, the presser foot comes down.

TYPES OF PRESSER FEET AND THEIR APPLICATIONS

Presser foot	Standard presser foot									
Symbol	A									
Stitch pattern selection key										
Typical applications	Straight stitch Quilting Pintuck	Stretch reinforcing stitch	Zigzag stitch Applique Quilting	Overcasting	3-step zigzag stitch (elastic stitch)	Pattern stitch, patchwork, etc.	Pattern stitch, patchwork, etc.	Pattern stitch, patchwork, etc.	Overcasting, etc.	Pattern stitch

Presser foot	Zipper sewing presser foot	Overcasting presser foot	Blindstitch presser foot	Buttonholing presser foot
Symbol	B	C	D	E
Stitch pattern selection key				
Typical applications	Setting zipper	Overcasting (overlocking)	Blindstitch	Automatic buttonholing

Stitch length of each stitch pattern

When a stitch pattern is selected, the optimum stitch length for the selected pattern is automatically set. If you want to set the stitch length to your desired length, use the stitch length manual keys.

Stitch length	Stitch pattern selection key																	
	Automatic																	
Manual	00 S 4.0	00 S 4.0	00 S 4.0	00 S 4.0	00 S 1.0	00 S 1.0	--	00 S 4.0	00 S 4.0	--	--	--	--	--	--	--	00 S 4.0	--
Automatic	2.0 (LENGTH)	1.0 (LENGTH)	1.5 (LENGTH)	2.5 (LENGTH)	0.5 (LENGTH)	0.5 (LENGTH)	-- (LENGTH)	2.0 (LENGTH)	1.0 (LENGTH)	-- (LENGTH)	-- (LENGTH)	-- (LENGTH)	-- (LENGTH)	-- (LENGTH)	-- (LENGTH)	-- (LENGTH)	0.5 (LENGTH)	-- (LENGTH)

- * If is indicated when you have selected a stitch pattern, it means that the stitch length suited to that selected pattern has been set automatically. In this case, no stitch length will be shown on the digital display. The indication remains unchanged even if the stitch length manual key is pressed.

*How to use the stitch length manual keys

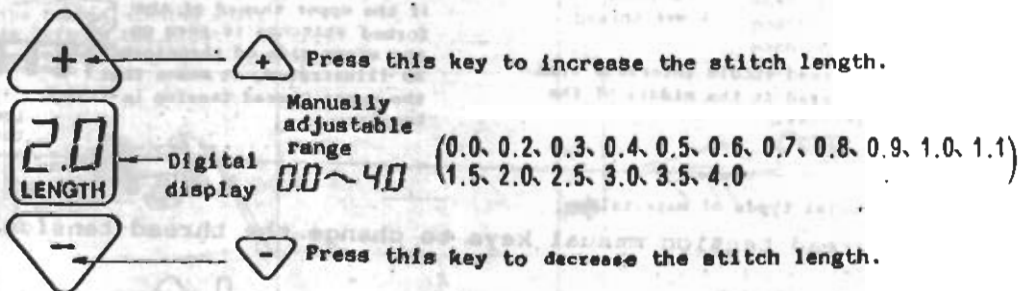

For straight stitching

Automatic Stitch length

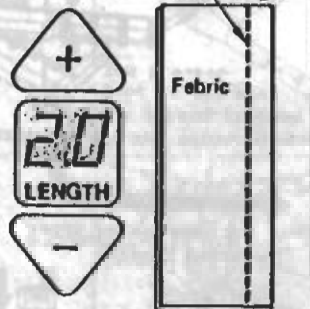

Manual setting examples

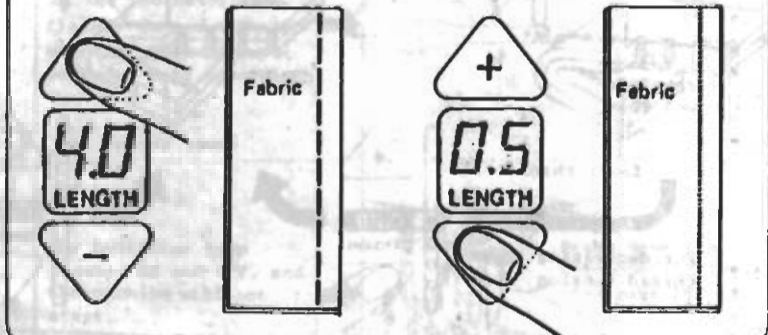

● AUTOMATIC THREAD TENSION CONTROL

The thread tension is automatically controlled by computer.

The thread tension is controlled so that the upper thread interlaces with the lower thread at the middle of fabric thickness as shown below.

*The thread tension control mode is set to "AUTO" whenever the power switch is turned ON or a stitch pattern is reselected.

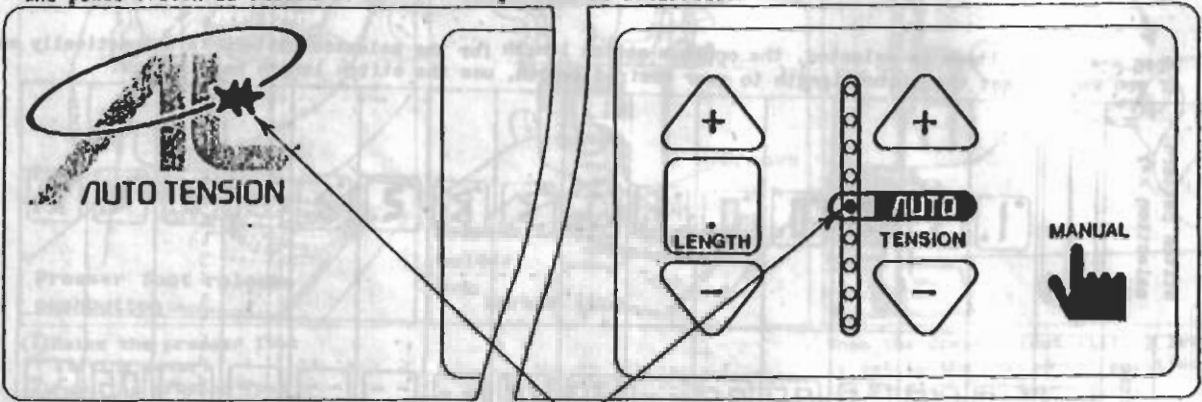

Indication of automatic thread tension control (When the thread tension control mode is automatic, the "AUTO" indicator lamp lights.)

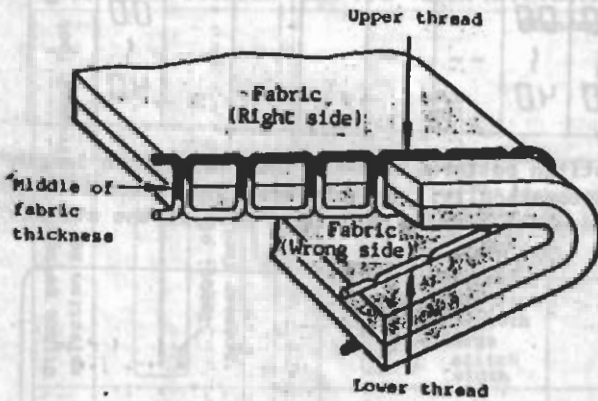

- The upper thread should interlace with the lower thread at the middle of the fabric thickness.

Useful information

If the lower thread of the formed stitches is seen on the right side of the cloth as illustrated, it means that the upper thread tension is too high.

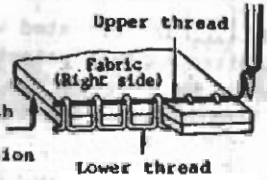

If the upper thread of the formed stitches is seen on the wrong side of the cloth as illustrated, it means that the upper thread tension is too low.

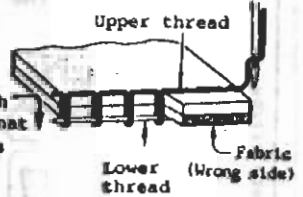

For sewing special types of materials

Use the thread tension manual keys to change the thread tension.

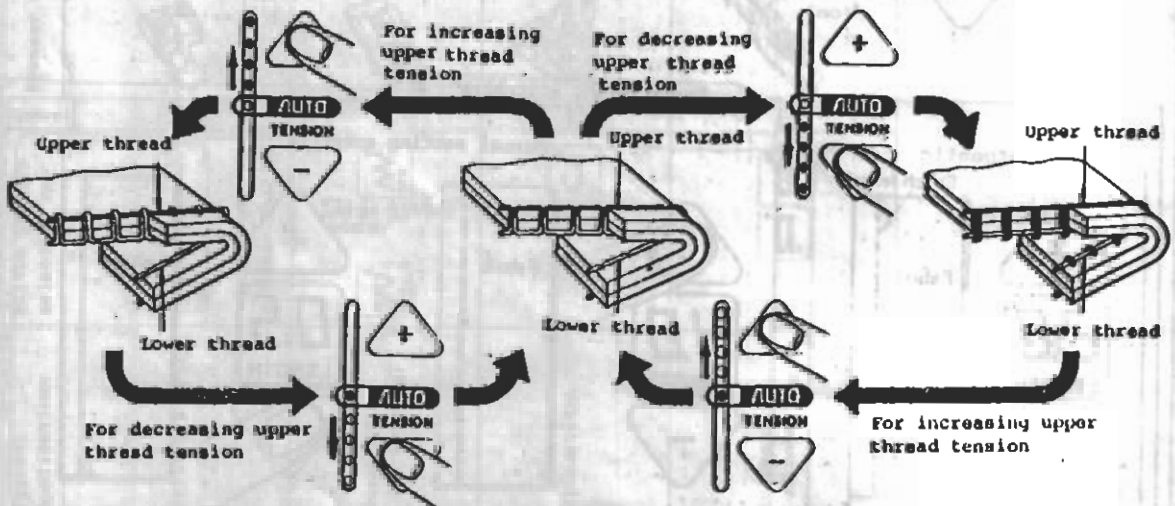





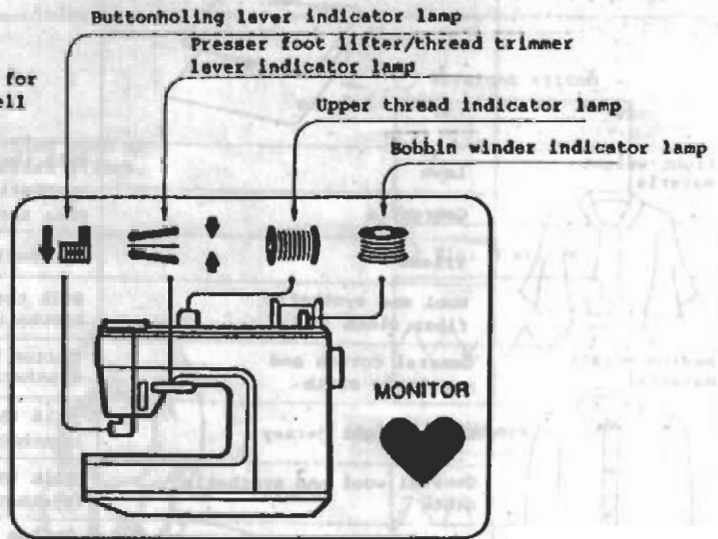

● HELPFUL MONITORS

If the machine has not been properly set for start, a monitor lamp will light up to tell you the error.

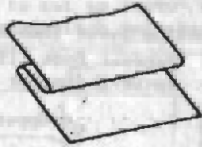

Indicator lamp lights up.			Action to be taken (When the following corrective action is taken, the indicator lamp will go OFF.)
Indicator lamp	Error	When the start switch is pressed	
	<p>Bobbin winding shaft</p> <p>The bobbin winding shaft is left in the right position for winding.</p>	<p>The machine forms only one stitch, then stops. The bobbin winding shaft turns.</p>	<p>Move the bobbin winding shaft back to the left position after the machine stops.</p>
	<p>The upper thread has run out.</p>	<p>—</p>	<p>Replace the empty spool, then press the start switch.</p>
	<p>The presser foot is up, and the thread trimmer is in the actuated condition.</p>	<p>Arrow</p> <p>The indicator lamp flashes ON and OFF, and machine stops after it produces only one stitch.</p>	<p>Bring down the presser foot lifter/thread trimmer lever to the horizontal position.</p>
	<p>Buttonholing lever</p> <p>The buttonholing lever has not been set.</p>	<p>The indicator lamp flashes ON and OFF, and the machine will not start.</p>	<p>Bring down the buttonholing lever. (See page 14).</p>

● HOW TO SELECT NEEDLE AND THREAD SUITED TO THE MATERIAL

	Cloth 	Thread 	Needle 
Light-weight material 	Lawn	Silk thread - #50 to #100	(No. 9)
	Georgette	Synthetic thread/ Fine thread - #90 to #100	No. 11
	Tricot	Synthetic thread - #50/60	Knitting needle No. 11
	Wool and synthetic fiber cloth	Silk thread - #50 Synthetic thread - #50/60	No. 11
Medium-weight material 	General cotton and synthetic cloth	Cotton thread #50 to #80 Synthetic thread - #50/60	No. 11-14
	Light-weight jersey	Silk thread - #50 Synthetic thread - #50/60	Knitting needle No. 11
	General wool and synthetic cloth	Silk thread - #50 Synthetic thread - #50/60	No. 11-14
Heavy-weight material 	Denim	Cotton thread #30 to #50 Synthetic thread - #50	No. 14-16
	Jersey	Silk thread - #50 Synthetic thread - #50/60	Knitting needle No. 11-14
	Coating	Silk thread - #50	No. 11-14

*The knitting needles (HAKKN) effectively prevent stitch skipping, and are ideal for sewing stretchy materials.

● HOW TO ATTACH/DETACH THE NEEDLE



CAUTION: Make sure the power/lamp switch is off before inserting the needle.

1 Detaching the needle

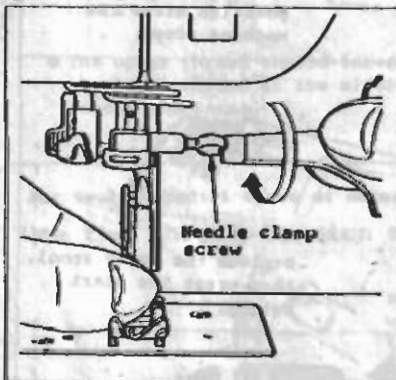

- (1) Turn the handwheel toward you to until the needle bar reaches its highest position.
- (2) Loosen the needle clamp screws.

2 Attaching the needle (The needle cannot be attached unless it is correctly oriented.)

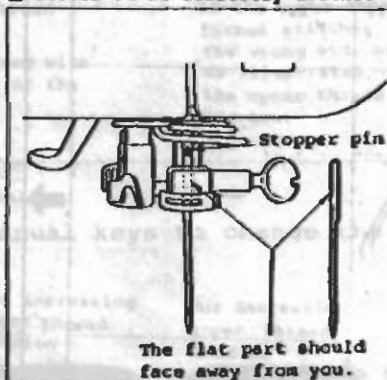

Hold the needle with its flat part pointing away from you, and insert it fully until it touches the stopper pin.

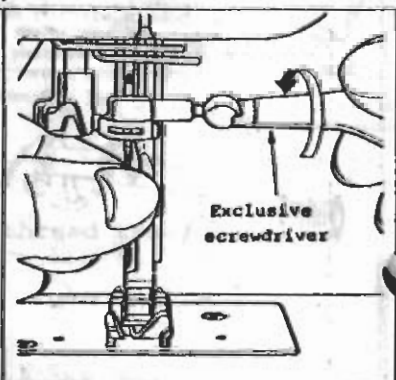

Securely tighten the needle clamp screw, using the exclusive screwdriver furnished with the machine.

Needles to be purchased:
When purchasing spare needles, specify HAK1 for household sewing machine or HAK1KN (knitting needle).



Needle size

The larger the number, the thicker the needle.

How to check the needle



A good needle should show an even clearance between itself and the flat plate to the point of the needle. Do not use any bent or crushed needle.

VARIOUS TYPES OF STITCHES

You can perform various types of stitching such as straight stitch, buttonholing, cylindrical stitch, applique, and blindstitch.

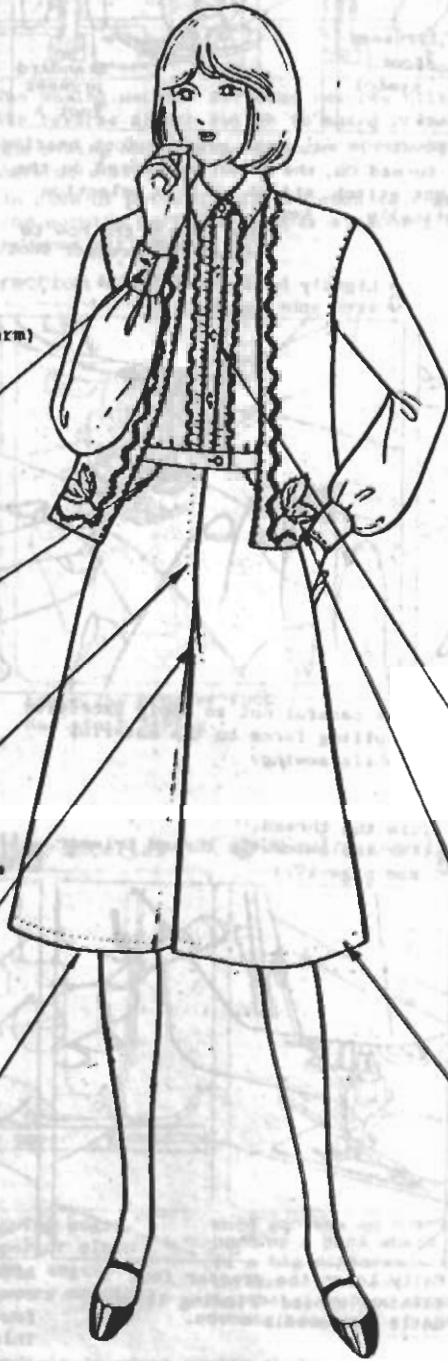

● Cylindrical stitch (free arm)

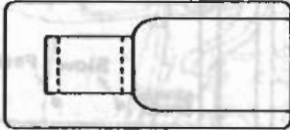

● 3-step zigzag stitch

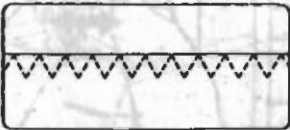

● Zipper sewing



● Reinforcing stretch stitch



● Overcasting

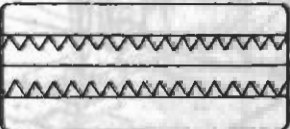

○ Straight stitch

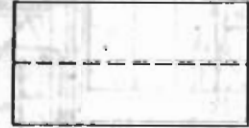

○ Zigzag stitch

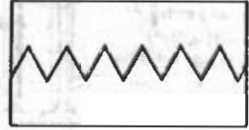

○ Patchwork

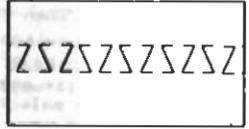

○ Quilting

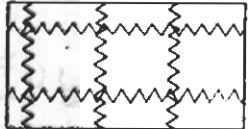

○ Pintuck



● Buttonholing

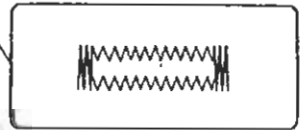

● Applique

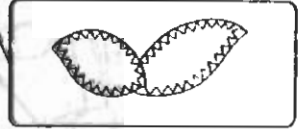

● Blindstitch

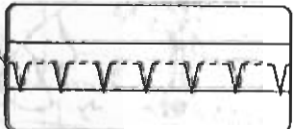

STRAIGHT STITCH

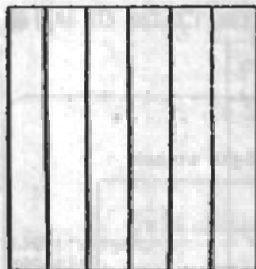

Stitches produced in automatic mode. The straight stitch is the basic stitch. Select needle (and thread suited to the material) to be sewn.



Needle entry position

1 Select a stitch pattern.

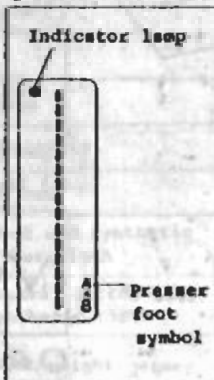

When the power switch is turned ON, the straight stitch is automatically selected.

2 Make sure that the presser foot is correct.

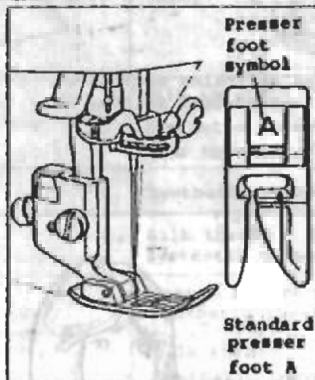

Use the presser foot bearing the symbol indicated on the stitch pattern selection key.

* See page 9 for how to attach the presser foot.

3 Set the material, and lower the presser foot.

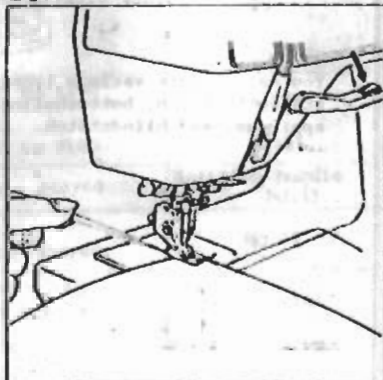

Place the material under the presser foot, and let the needle enter the sewing start point of the material. Pull both the upper and lower threads to the rear of the presser foot before moving the presser foot down.

4 Start the sewing machine

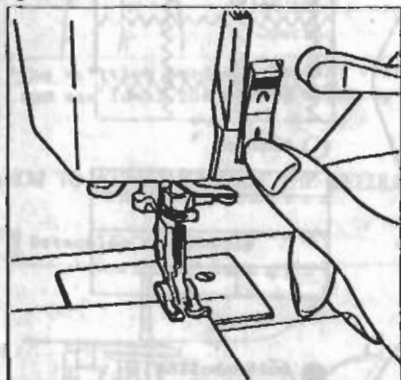

Press the start/stop switch.

5 Lightly hold the material with your hands.

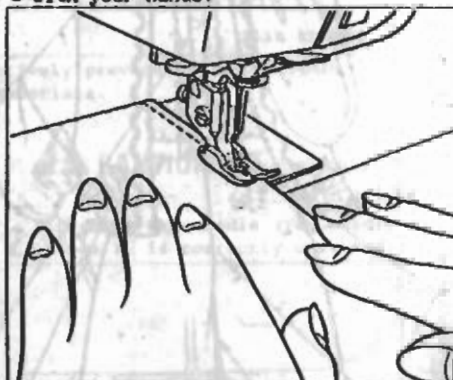

Be careful not to apply excessive pulling force to the material while sewing.

6 Adjust the sewing speed.

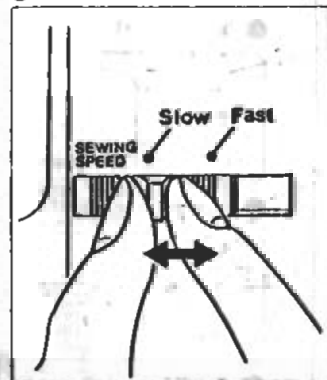

7 Stop the sewing machine.

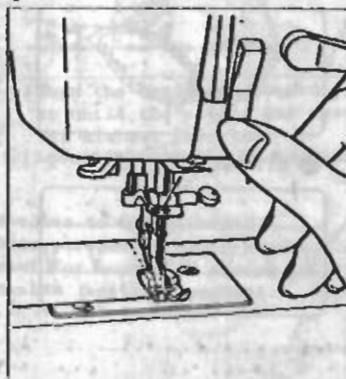

Press the start/stop switch.

Trim the thread.

8 (For the automatic thread trimmer, see page 17.)

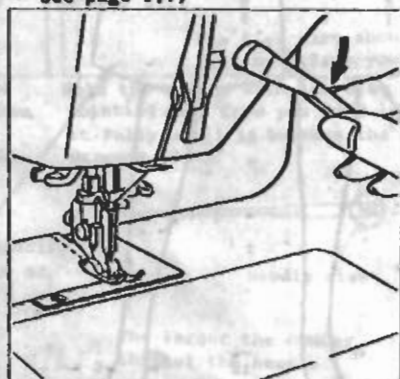

Fully lower the presser foot lifting/thread trimming lever until the needle moves.

9 Lift the presser foot and remove the material.

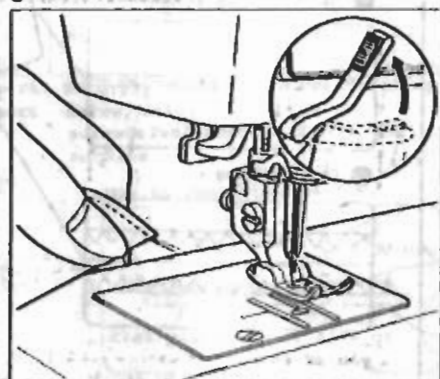

After confirming that the needle has completely stopped, raise the presser foot lifting/thread trimming lever. This will cause the upper and lower threads to be trimmed at a time, enabling you to remove the material from the machine.

● ***Reverse stitch (for prevention of seam unravelling)**

Reverse feed stitches formed at the start and end of a seam will prevent the seam from unravelling.

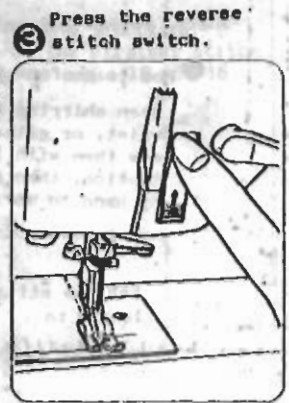
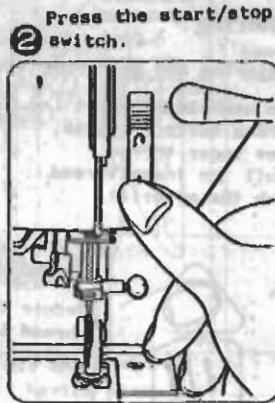
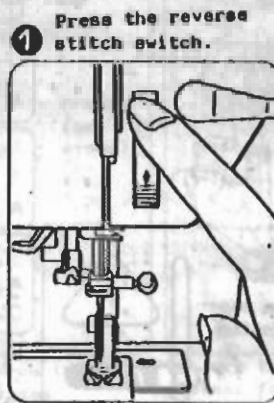

- The sewing machine performs reverse stitching only while the reverse stitch switch is being pressed.
- The sewing machine runs at low speed when performing reverse stitching.
- In case of pattern stitches such as zigzag stitch, the machine performs stopper stitching instead of reverse stitching.

● ***Changing the stitching direction**

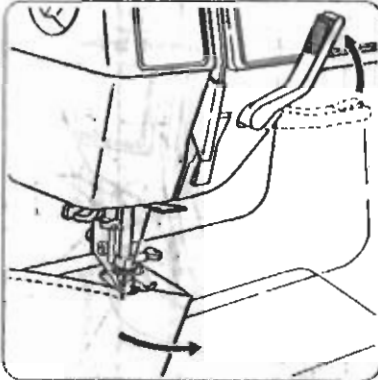

Stop the machine in the desired position, lift the presser foot, turn the material with the needle piercing the material, and correctly set the material in the desired sewing direction.

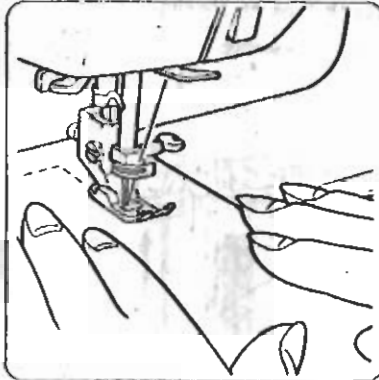

Lower the presser foot and start sewing.

● ***Sewing start for heavy-weight material**

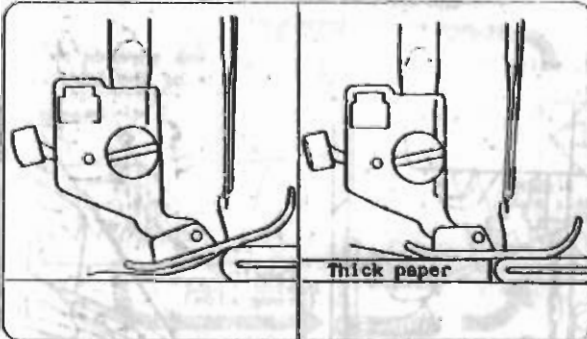

When you start sewing with overlapping edges, it is advisable to place thick paper or cloth which is as thick as the overlapping edges. By so doing, you can start sewing very smoothly.

● ***Sewing overlapping seam allowances**

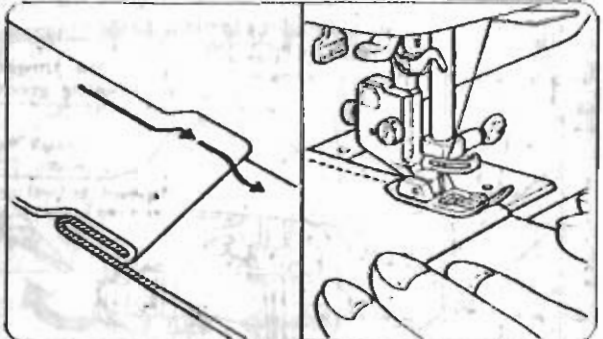

When you sew an overlapping Hold the material lightly to part or a part where there is a big difference in thickness, be sure to sew in the direction shown above. Do not sew against the overlapping part.

Hold the material lightly to aid the feed motion of the feed dog, and sew it slowly.

When you sew light-weight material, slowly start sewing while lightly pulling the upper and lower threads in the sewing direction.

*Shirring and gathering

● How to perform shirring and gathering (straight stitch)

When shirring an armhole or skirt waist, or gathering cuffs or yokes, sew them with low upper thread tension, then pull the lower thread by hand to shrink the material.

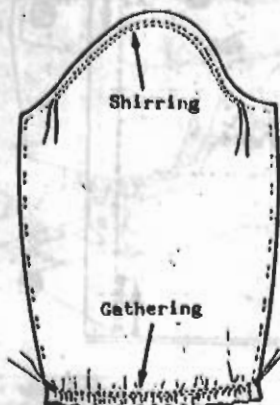
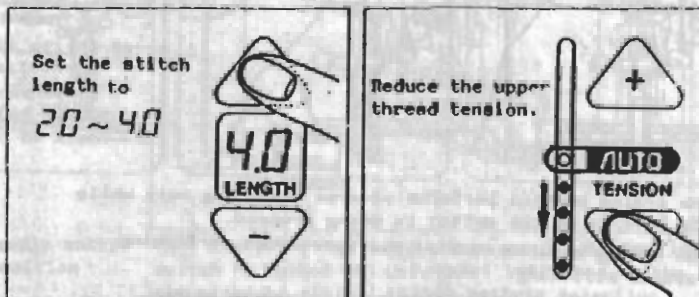

*How to operate the automatic thread trimmer

It is advisable to use the automatic thread trimmer at the end of sewing. Use the thread trimming groove for trimming thick threads of count 30 or more or a special type of thread.

1 Lower the thread trimming lever.

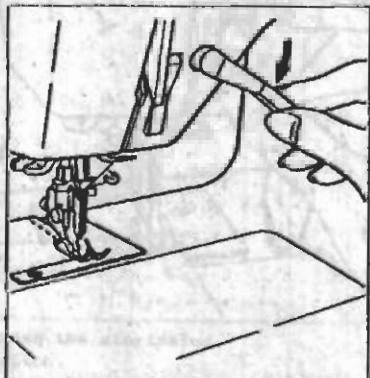

Upon completion of sewing, fully put down the thread trimming lever.

2 Needle goes up.

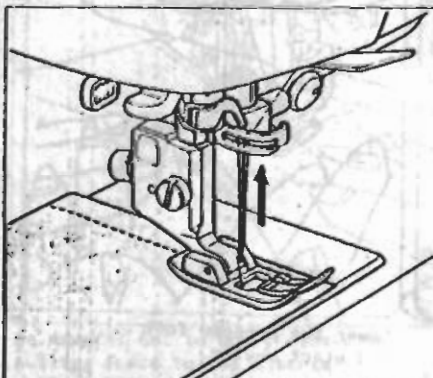

The needle goes up, and the upper and lower threads are trimmed. The needle stops in the upper position.

3 Raise the thread trimming lever.

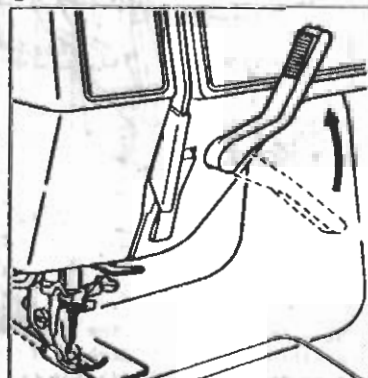

After confirming that the needle has completely stopped, raise the thread trimming lever.

*How to use the thread trimming groove

(How to knot the threads)

1 Remove the material from the machine.

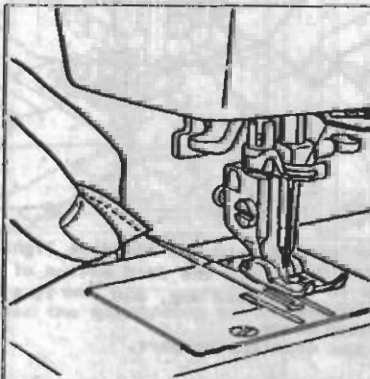

After finishing a seam, raise the needle and the presser foot in order, and slowly pull the material off the machine.

2 Cut the threads, using the thread trimming groove.

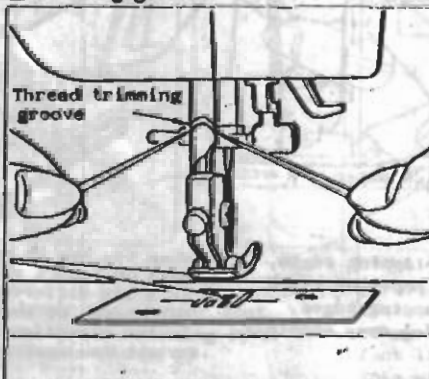

Hold the upper and lower threads together, pull them out about 10cm, and cut them with the thread trimming groove located at the rear of the presser foot.

3 Knot the two threads on the wrong side of the fabric.

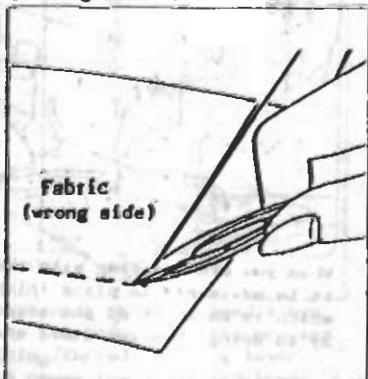

Pull out the upper thread onto the wrong side of the fabric, and knot the upper and lower threads. Cut the threads as close to the knot as possible.

ZIGZAG STITCH

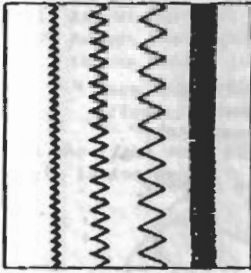

1 Select the desired stitch pattern.

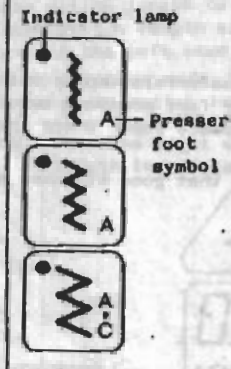

Select from the three zigzag stitch patterns.

2 Check that the presser foot is the correct one.

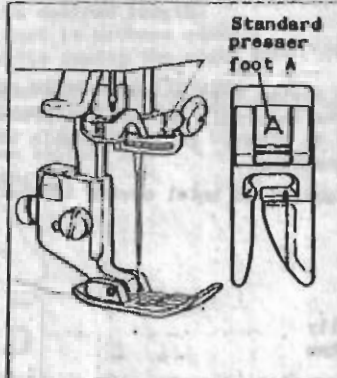









Be sure to use the presser foot having the symbol indicated on the stitch pattern selection key.

- See page 9 for how to attach the presser foot.

3

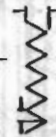
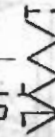
The sewing method is the same as the straight stitch. Refer to pages 15 and 16.

Stitch width vs. stitch length

Stitch pattern selection key			
Stitch width	Min. (1.7)	Medium (3.3)	Max. (5)
Stitch length	Auto-matic 10 	15 	25 
	Manual 0.2 ~ 4.0 	0.2 ~ 4.0 	0.2 ~ 4.0 

• Stopper stitch (reverse stitch)
Stopper stitches formed at the start and end of a zigzag seam will prevent the seam from unravelling.

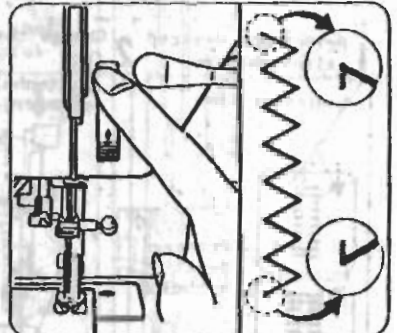

Press the reverse stitch switch at the start and end of sewing.

Use the thread tension manual adjustment keys when you need to change the thread tension.

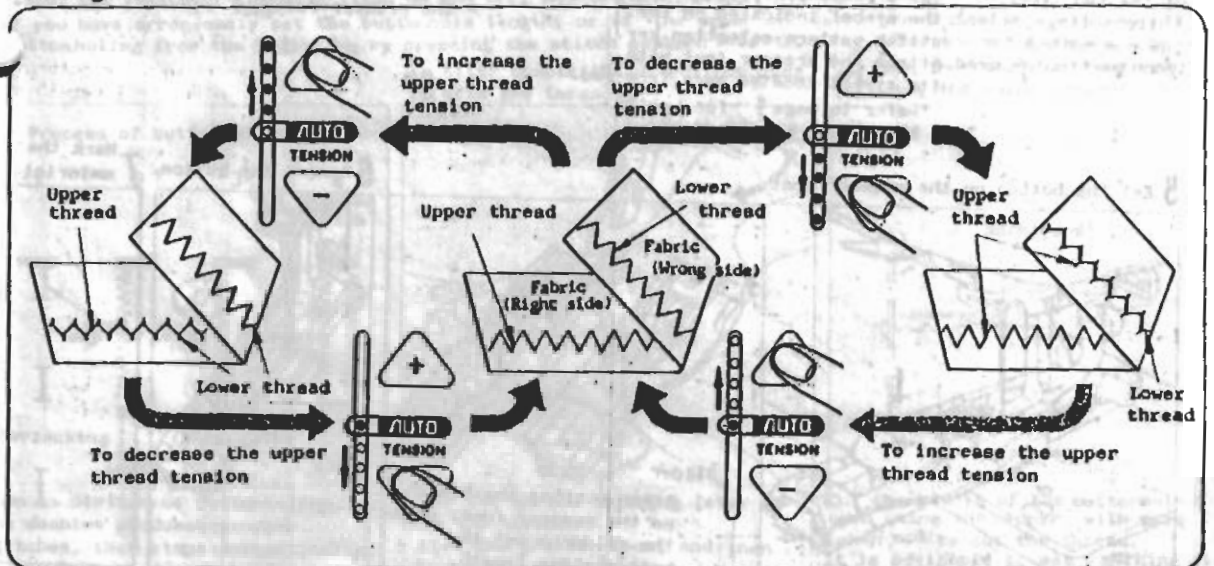

AUTOMATIC BUTTONHOLING



Buttonholing, which traditionally requires much time and skill, can be done automatically.

When sewing knit or other stretchy materials, apply interlining to the material, and set the presser foot pressure adjustment dial to "LOW". It is advisable to place paper under the material when sewing.

Be sure to do trial sewing to check that good stitches are formed.



Suited for sewing small buttonholes in men's shirts, blouses, etc.



Suited for sewing large buttonholes in coats.

- 1 Select the desired stitch pattern.
- 2 Change the presser foot.
- 3 Set the sewing speed.
- 4 Pull out the upper and lower threads.

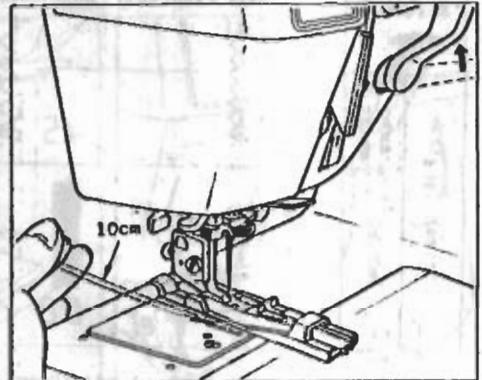
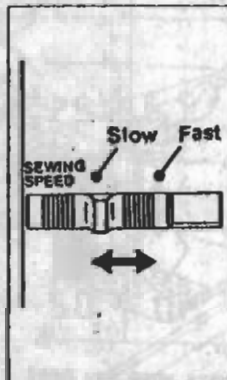
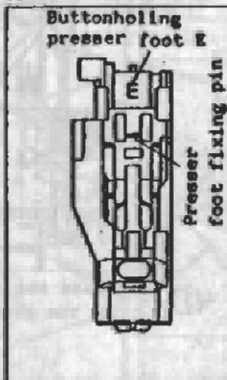
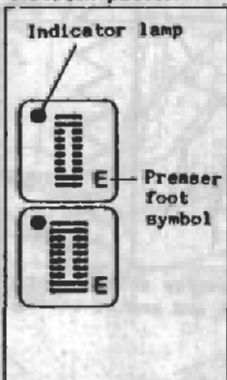

Of the two types of buttonholings, select the one suited for your particular need.

Use a presser foot which has the symbol indicated on the stitch pattern selection key. Attach the presser foot with its symbol located away from you.

*Refer to page 9 for how to attach the presser foot.

Pass the upper thread under the presser foot.

- 5 Set the button on the presser foot.

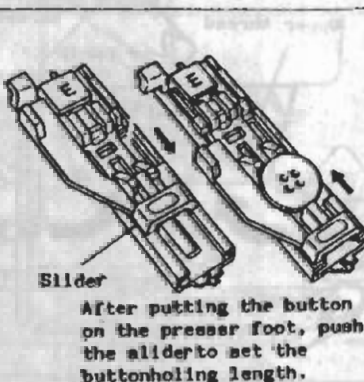
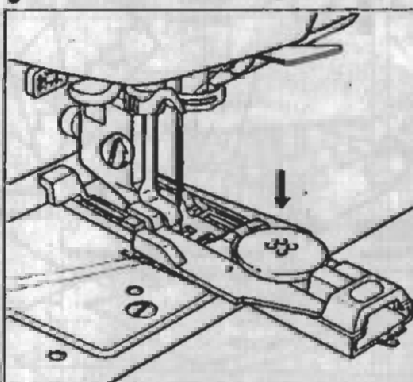

After putting the button on the presser foot, push the slider to set the buttonholing length.

- 6 Remove the button.
- 7 Mark the material.

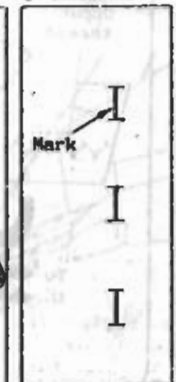
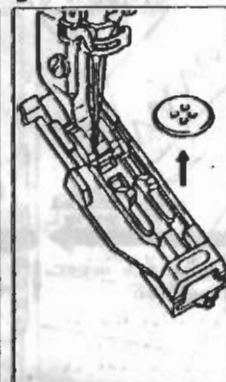

The buttonholing length is automatically determined simply by setting the button on the presser foot. (If the button cannot be set on the presser foot, the buttonholing length is determined by adding the major axis of the button to the button thickness.)

After the buttonholing length has been set, take off the button.

Mark the buttonholing positions with "I" using a chalk.

If the stitch length of the right seam does not agree with that of the left seam, adjust as follows:

1. Adjust the left seam stitch length to the desired length.
2. Adjust the right seam stitch length so that it becomes equal to the stitch length of the left seam while sewing the right seam.

* Once the adjustment has been made, the adjustment remains effective until the power switch is turned OFF or another stitch pattern selection is made.

When the right seam stitch length is too small;

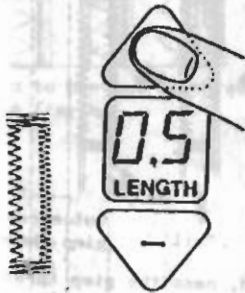

When the right seam stitch length is too large;

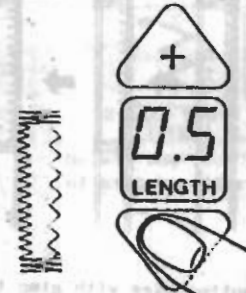

8 Lower the presser foot

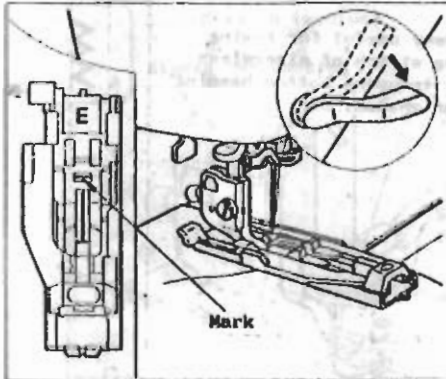

Lower the presser foot so that the mark is at the center of the needle hole in the presser foot.

9 Lower the buttonholing lever.

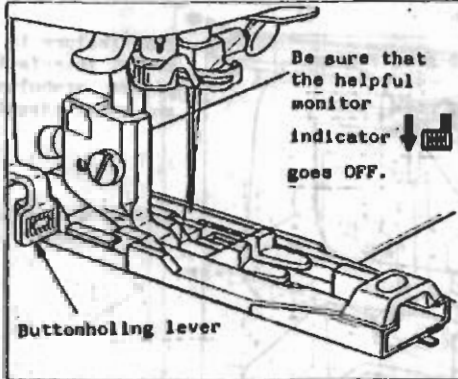

When the buttonholing lever is fully lowered, the helpful monitor indicator will go OFF.

10 Start sewing.

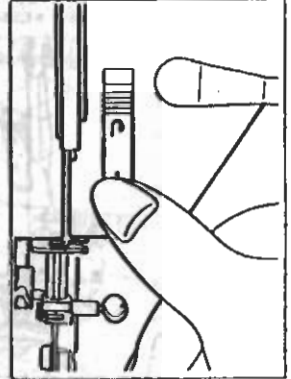

Press the start/stop switch.

*If you try to start sewing without lowering the buttonholing lever, the indicator will flash ON and OFF, and the machine will not start.

*If you have erroneously set the buttonhole length, or if the upper or lower thread runs out, you can restart buttonholing from the beginning by pressing the stitch pattern selection key after stopping the machine once.

12 After completion of buttonholing, trim the threads.

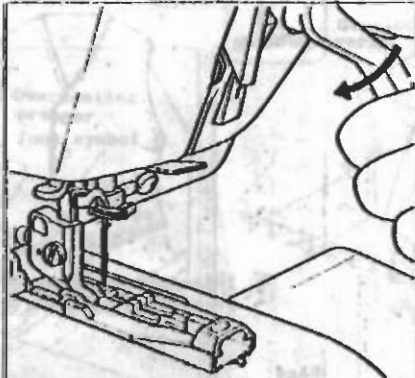

Lower the thread trimming lever to trim the threads.

* Lift the presser foot, and then lower it so that the second buttonhole mark is set at the center of the needle hole in the presser foot.

13 Open the completed buttonhole, using the seam ripper.

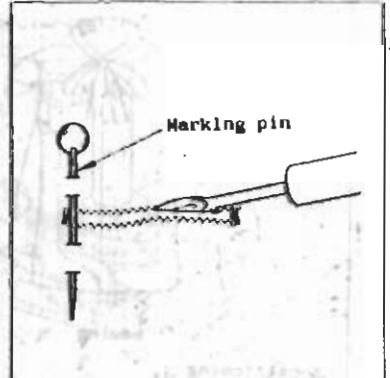

Cut the middle of the buttonhole open using the ripper, with care taken not to cut the thread. It is advisable to set a marking pin on one end of the buttonhole. This will help prevent overcutting.

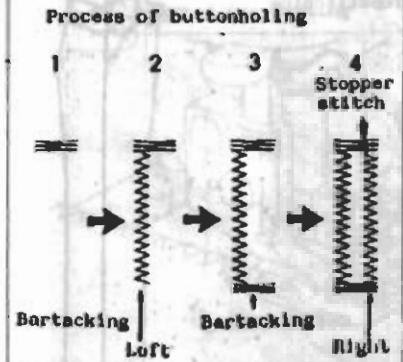

Upon completion of buttonholing, the machine produces stopper stitches, then stops automatically.

***Sewing buttonholes with gimps**

If you use gimp thread for buttonholing, it will prevent buttonholes from becoming loose and ensure durable buttonholes. Lace yarn or silk buttonhole twist is used for gimp thread.

How to set the gimp

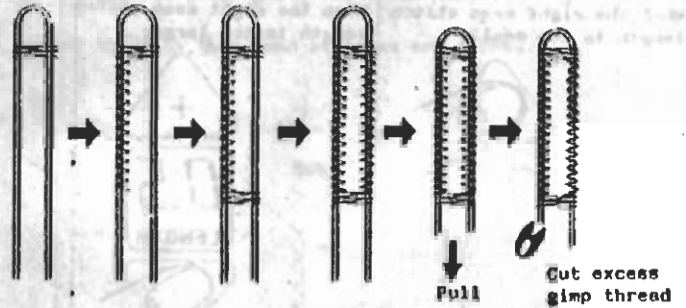
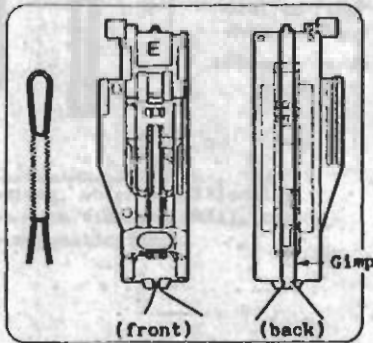

When you sew buttonholes with gimp thread, pass the gimp thread through the end of buttonholing presser foot and knot the ends of the threads on your side. Then, attach the buttonholing presser foot to the presser bar. In this way, you can sew buttonholes with gimp thread.

Free arm (tubular) stitch

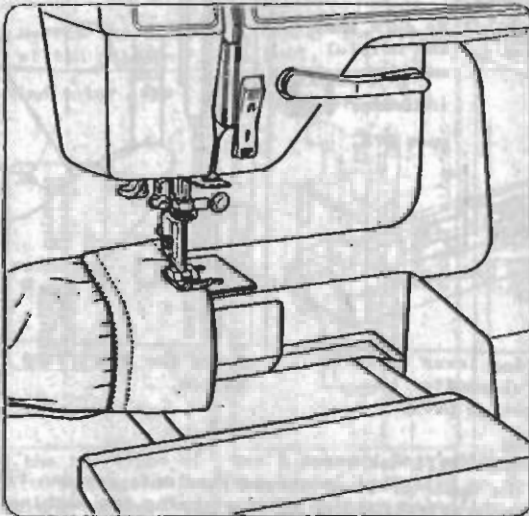

This feature is very useful for sewing cuffs, interfacing stitch of sleeveless pieces, armholes, trousers bottom hemming and other circular shapes.

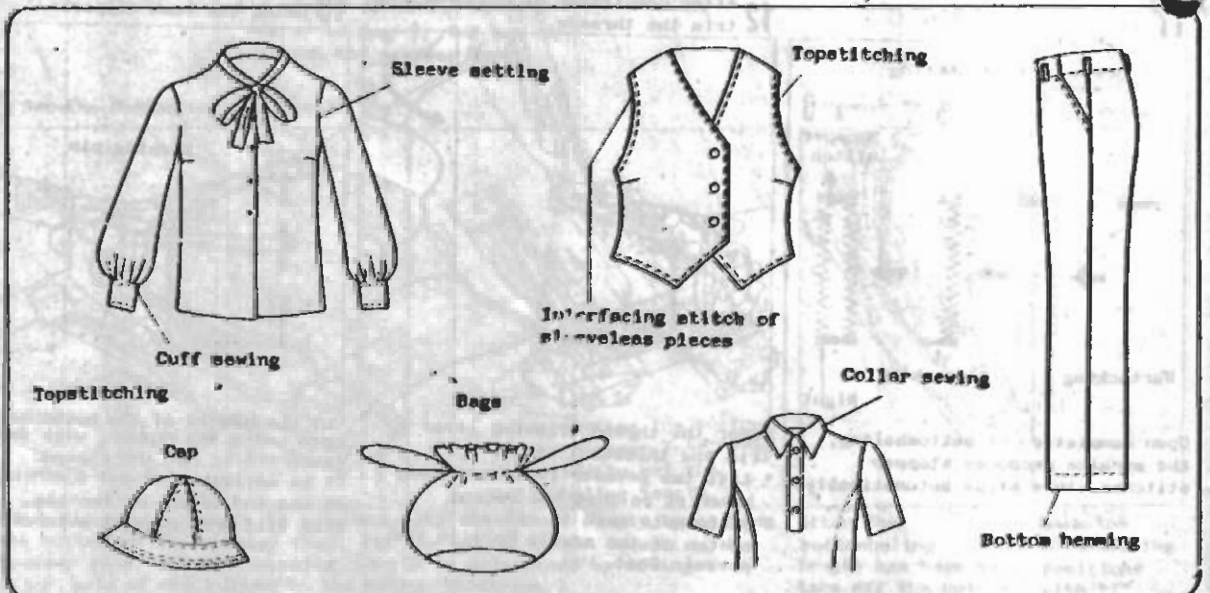

OVERCASTING (OVEREDGING)

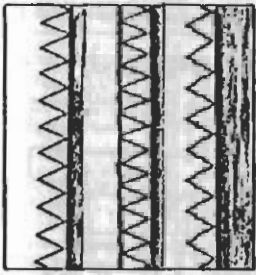

Used to prevent cloth edge from fraying.

1 Select the desired stitch pattern.

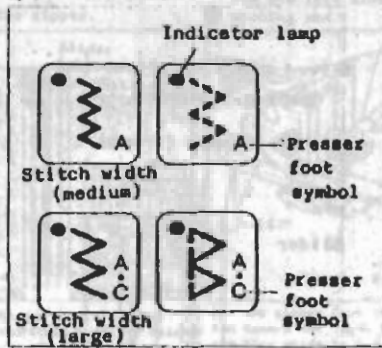

Select one from the above four types of stitch patterns.

2 Replace the presser foot.



• Be sure to use the standard presser foot for the medium stitch width and 3-step zigzag sewing.

Standard presser foot A



• Stitch width (large)
• Overlock

Overcasting presser foot C

Use the presser foot having the symbol indicated on the stitch pattern selection key.
• See page 9 for how to attach the presser foot.



Stitch width (medium)

Zigzag overcasting

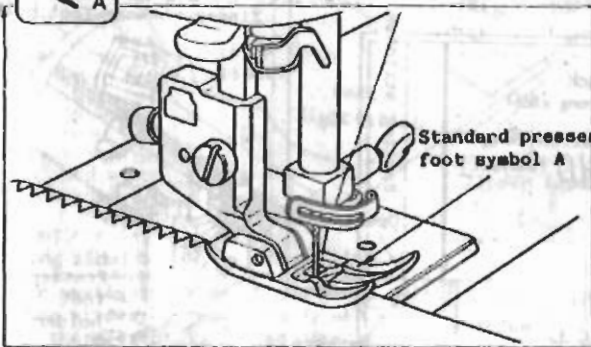

Used for overcasting light-weight material with curly edges



3-step zigzag overcasting

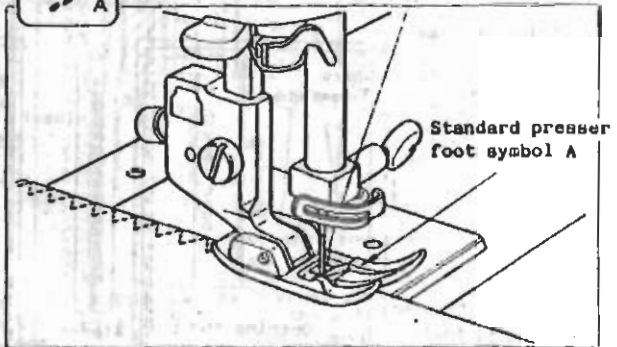

Used for stretchy material or materials which tend to fray. The needle should pierce the material at the point one or two texture yarns from the cloth edge.



Stitch width (large)

Zigzag overcasting

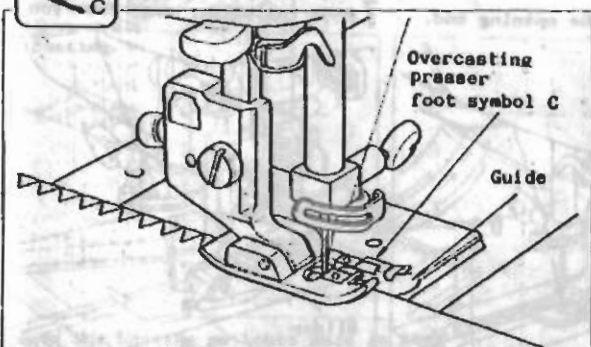

Extensively used for preventing cloth edges from fraying. Place the cloth edge against the presser foot guide to set the material so that the needle pieces close to the cloth edge.



Overlock overcasting

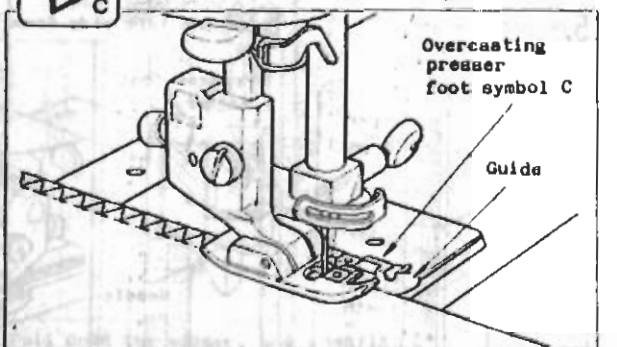

Designed to perform overedging and runstitching at a time. Ideally suited for stretchy material or materials which tend to fray when seam opening is unnecessary.

FITTING ZIPPERS

Fitting zippers to sides



For openings in shirts, slacks, one-piece dresses, etc.

● Part names of zipper and opening dimension

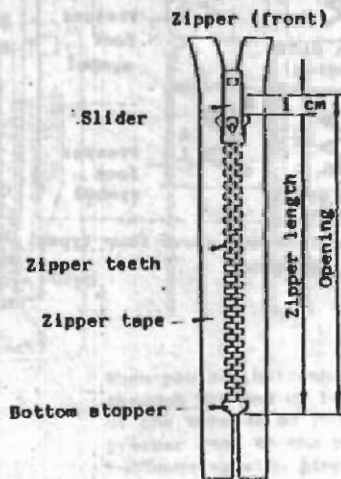

● Example of skirt

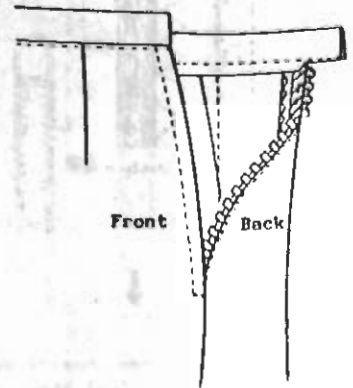

1 Select the desired stitch pattern.

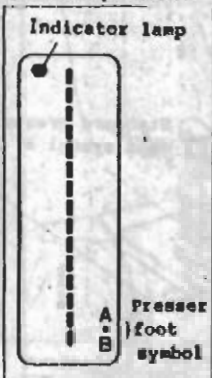

When the power switch is turned ON, the straight stitch is selected automatically.

2 Confirm the zipper opening length.

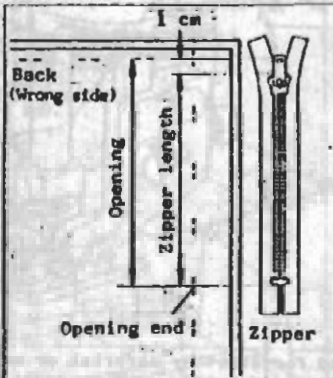

The opening length is the zipper length plus 1cm.

3 Perform basting and runstitching at a time, using the standard presser foot A.

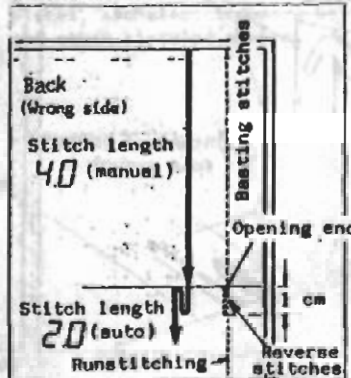

Place the front and back with their faces inside, and sew them in a large stitch length (4.0) from the cloth end to the opening end. Then, change the mode to "auto" to engage reverse feed stitching for one centimeter as shown above.

4 Change the presser foot

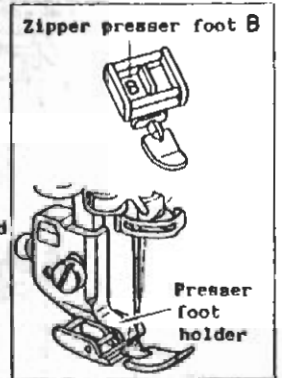

Use the presser foot, having the symbol indicated on the stitch pattern selection key. See page 9 for how to attach the presser foot.

5 Open the seam.

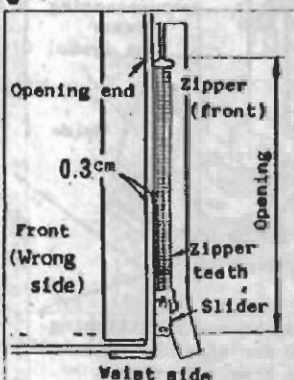

Fully open the seam, and expose the seam allowance of the back 0.3cm, then iron the exposed seam allowance to fold it. Place the folded edge close to the zipper teeth.

6 Sew the left side from the opening end.

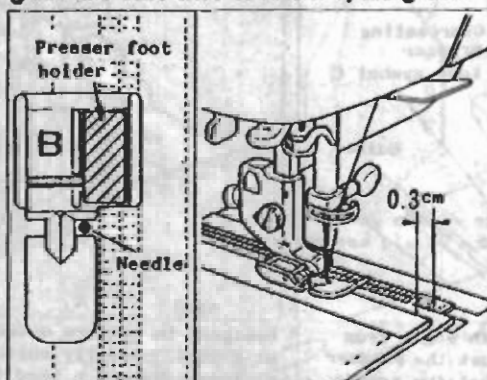

Position the zipper on the right to the zipper holder.

Place the zipper so that its teeth are close to the presser foot edge, attach one end of the zipper to the side of the back, and sew the zipper from the opening end.

7 Move the slider away from you.

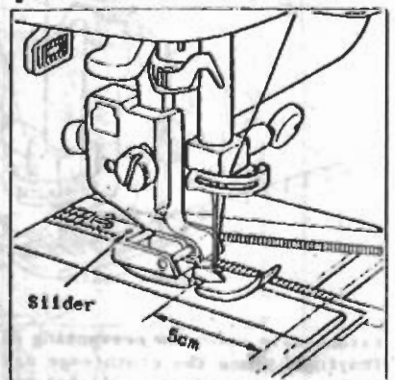

Stop sewing at about 5cm from the zipper end. Lift the presser foot, and move the slider away from you. Then, lower the presser foot and sew the zipper again to the end.

● Check the dimensions.

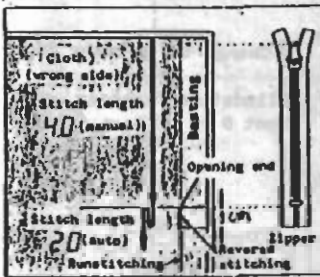

Perform basting and runstitching, using the standard presser foot A.

● Baste the zipper.

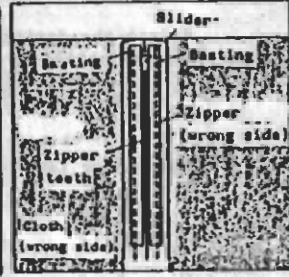

Open and fold the seam allowance sharply. Accurately butt the folded edges at the center line of the zipper teeth, then sew the zipper as illustrated. At this time, set down the slider tab toward the cloth edge.

● Sew the left side from the opening end.

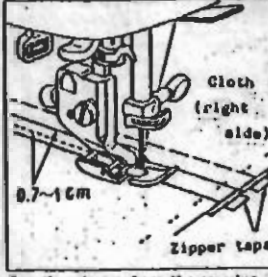

Sew the zipper from the opening end toward the cloth edge. (Sew the line which is 0.7 to 1cm away from the seam.)

● Sew the right side.

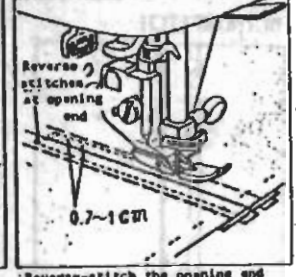

Reverse-stitch the opening end for reinforcement, and sew the right side along the line also 0.7 to 1cm away from the seam.

● Rip the basting stitches.

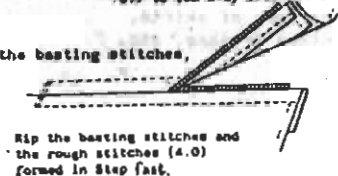

● Turn the front back.

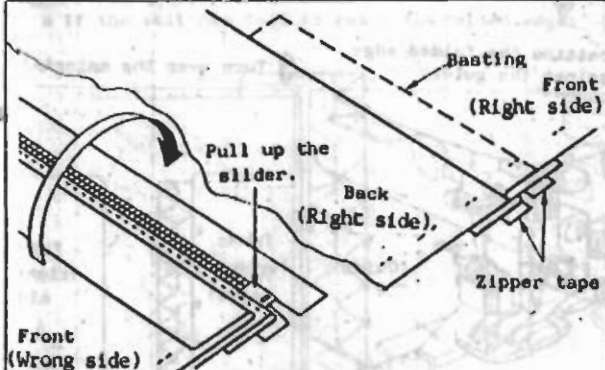

After sewing the side of the back, pull up the slider to the top end, and set down the slider tab in the direction illustrated above. Turn the front back over the zipper. Baste the front and the zipper tape.

9 Sew the right side.

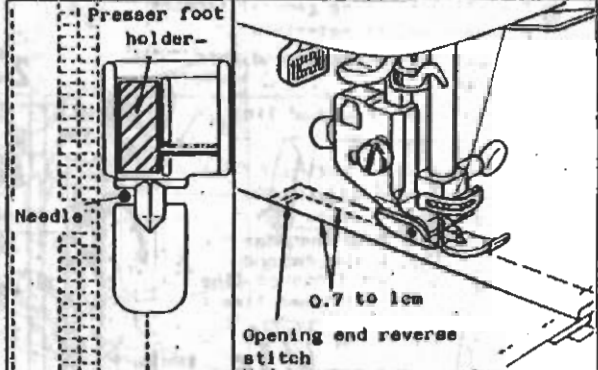

Place the zipper on the left to the zipper holder.

Reverse-stitch the opening end of the side of the front. Position the presser foot edge close to the slider, and sew the line which is 0.7 to 1cm away from the seam as shown above.

● Remove the basting stitches.

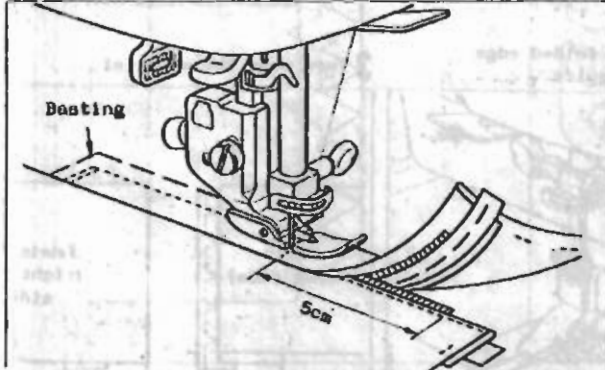

Remove the basting stitches made in Step 3, leaving about 5cm unremoved as shown above.

11 Pull down the slider.

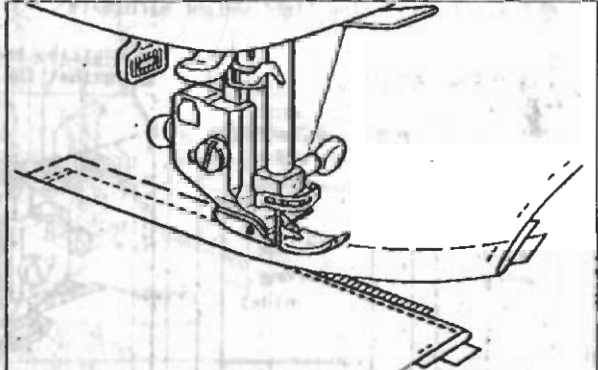

Pull down the slider, and sew the zipper to the end.

BLINDSTITCH

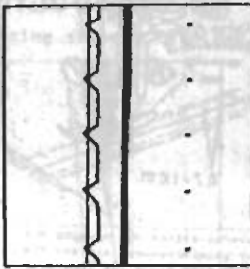

You can easily blindstitch the bottoms of skirts, one-piece dresses, etc.

1 Select the desired stitch pattern.

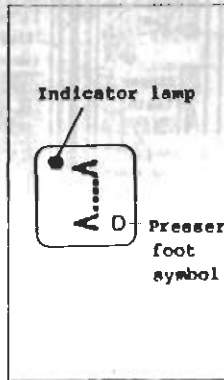

2 Change the presser foot.

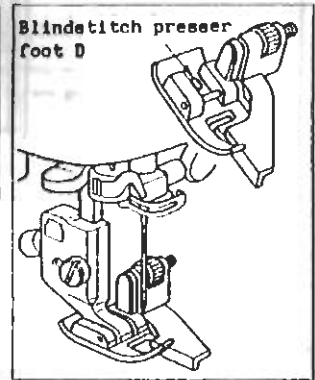

When the desired stitch pattern selection key is pressed, the stitch pattern is selected and the indicator lamp lights up.

Use the presser foot which has the symbol indicated on the stitch pattern selection key. Refer to page 9 for to attach the presser foot.

● For blindstitching general fabrics or heavy-weight materials

1 Overcast the material, and fold the edge.

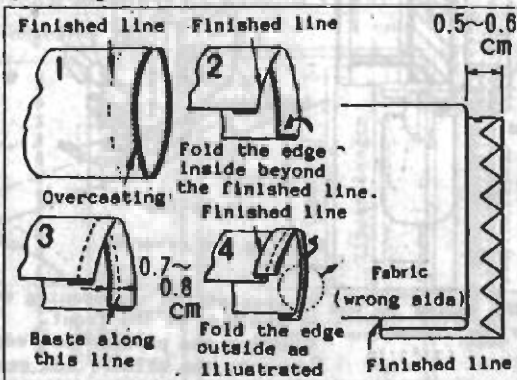

Refer to page 22 for overcasting.

2 Position the folded edge against the guide.

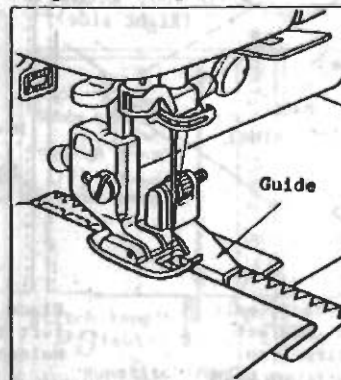

Place the folded edge closely against the presser foot guide, and sew the material.

3 Turn over the material

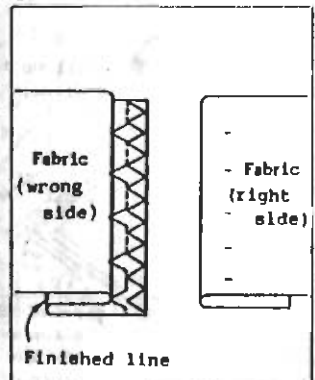

After finishing the seam, turn over the material.

● For blindstitching light-weight materials

1 Fold the fabrics

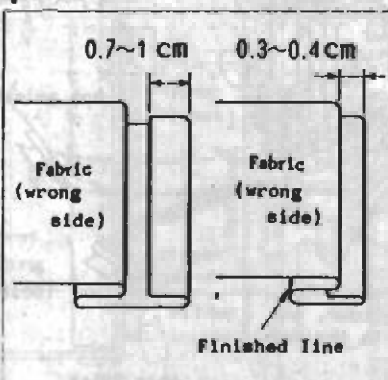

2 Position the folded edge against the guide.

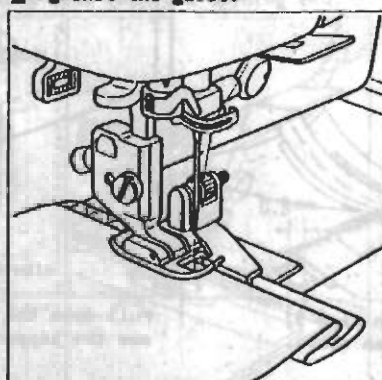

Place the folded edge closely against the presser foot guide, and sew the material.

3 Turn over the material

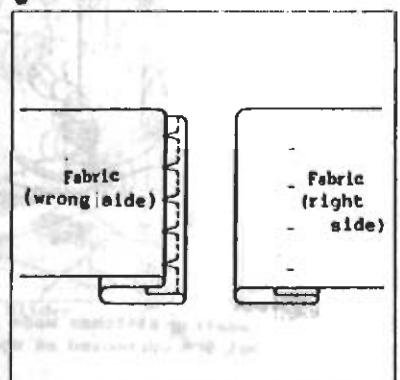

After finishing the seam, turn over the material.



How to adjust the guide of the blindstitching presser foot

■ If the stitches fail to reach the folded edge;

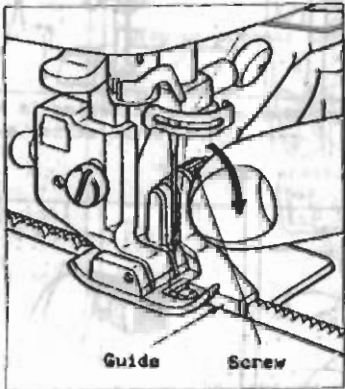

Turn the screw toward you. This will move the guide to the right. Place the folded edge snugly against the moved guide.

■ If the stitches excessively cover the folded edge;

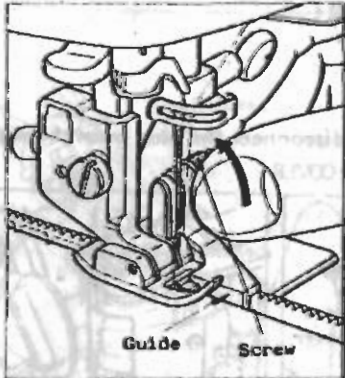
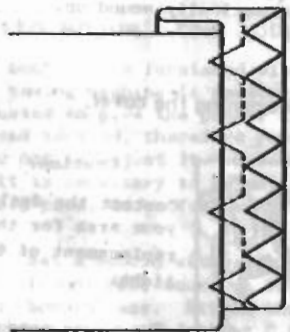

Turn the screw away from you. This will move the guide to the left. Place the folded edge snugly against the moved guide.

HOW TO USE THE CONTROL PEDAL

*When you use the control pedal, the start/stop switch can be used only for stopping the machine. Also, you cannot use the sewing speed adjusting lever.

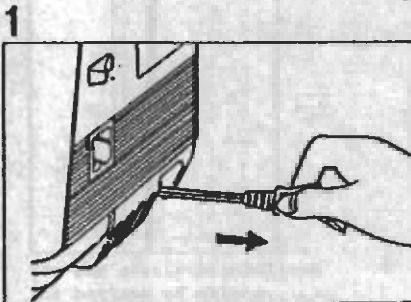

1 Pull out the cord and plug it into the receptacle.
*Stop pulling the cord out when the yellow mark is seen.

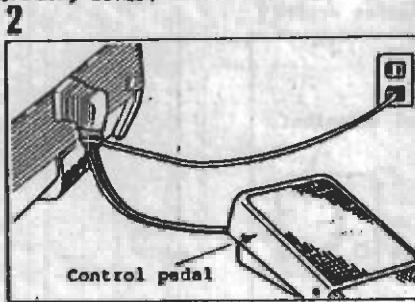

2 Plug the control pedal into the receptacle of the sewing machine.

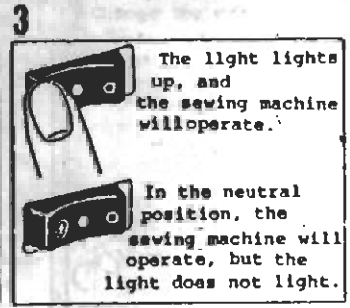

3 The light lights up, and the sewing machine will operate.

In the neutral position, the sewing machine will operate, but the light does not light.

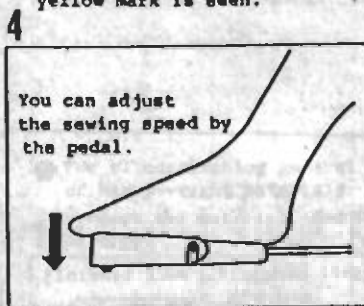

4 You can adjust the sewing speed by the pedal.

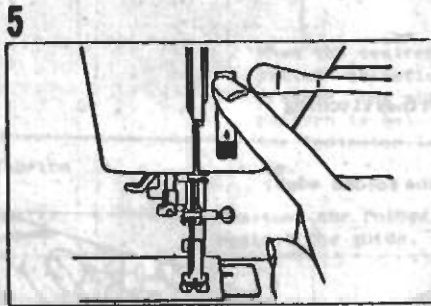

5 When reverse stitching is necessary, press the reverse stitch switch.

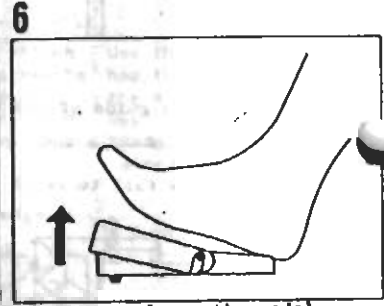

6 When you release the pedal, the sewing machine stops with the needle piercing the materials.

When you depress the control pedal, the sewing machine will start.

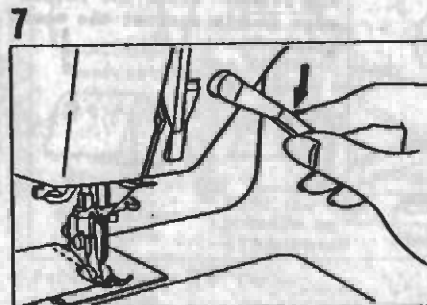

7 Lower the thread trimming lever to trim the threads. The needle goes up and stops in the upper position.

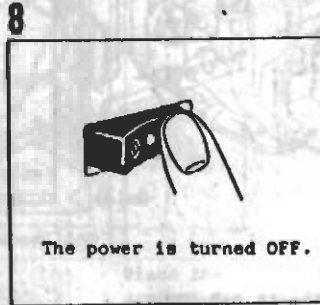

8 The power is turned OFF.

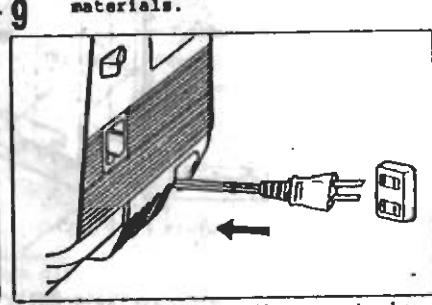

9 Remove the plug from the receptacle. Pull the cord reel a little, then release it. By so doing, the cord is automatically wound up.

CAUTION: Be sure to disconnect the plug from the wall outlet before opening the cover.

● HOW TO REMOVE THE FACE COVER

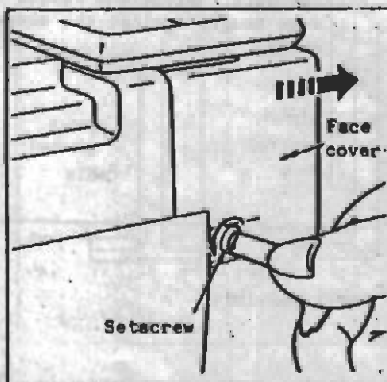

Loosen the setscrew at the rear of the face cover by about two turns, and draw it off sideways.

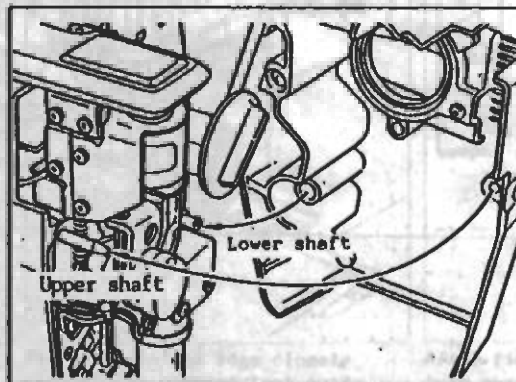

To close the face cover, align the two holes in the face cover with the two shafts of the main unit, and tighten the setscrew.

Caution:

Contact the dealer in your area for the replacement of the light.

The power consumption of the light is 15 watts.



CAUTION: Be sure disconnect the plug from the wall outlet before cleaning and lubricating the machine.

● Removing the fibrous wastes and dust

Accumulation of fibrous wastes or dust may cause trouble. Always keep your sewing machine clean.

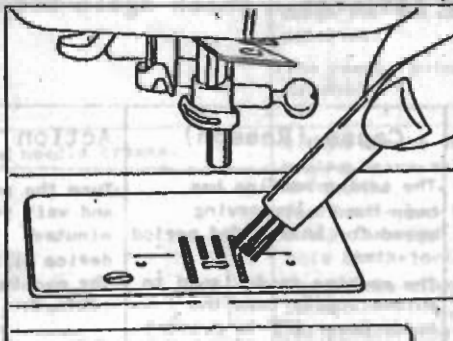

Remove the needle and presser foot, and clean the clearances between the feed dog teeth and the slots in the throat plate, using the brush furnished with the machine. If the clearances are clogged with much dust, use a vacuum cleaner.

* Be sure to turn the power switch OFF, and unplug the sewing machine.

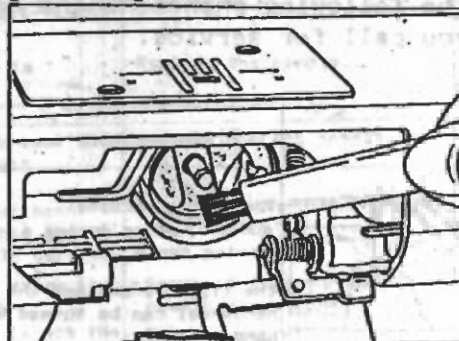

Always keep the periphery of the sewing hook by cleaning it with the brush or tweezers.

* Be sure to use only sewing machine oil for the machine.

This sewing machine uses special bearings, and requires no lubrication in normal use. However, if the machine is operated for an extended period of time or if it is operated after an extended disuse, lubricate the points indicated by the arrows shown below.

● Lubrication

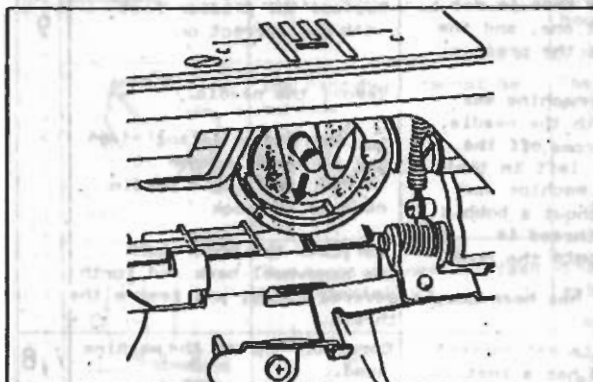

1 Open the hook cover, remove the bobbin case, and lubricate the hook.

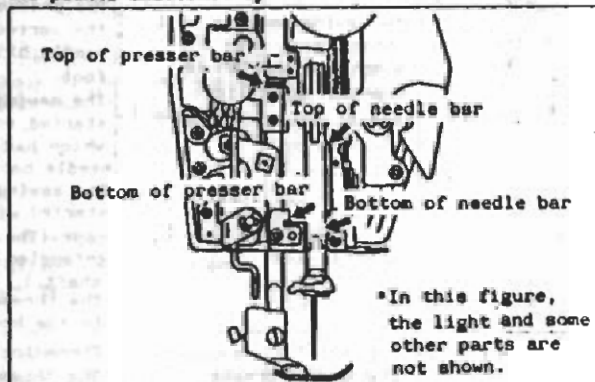

2 Open the face cover, and lubricate the tops and bottoms of the needle bar and the presser bar as indicated by the arrows.

* In this figure, the light and some other parts are not shown.

How to adjust the bobbin case



The bobbin case furnished with the sewing machine is factory-adjusted to give the proper lower thread tension, therefore you need not to adjust it. However, if it is necessary to adjust the bobbin case, do as follows:

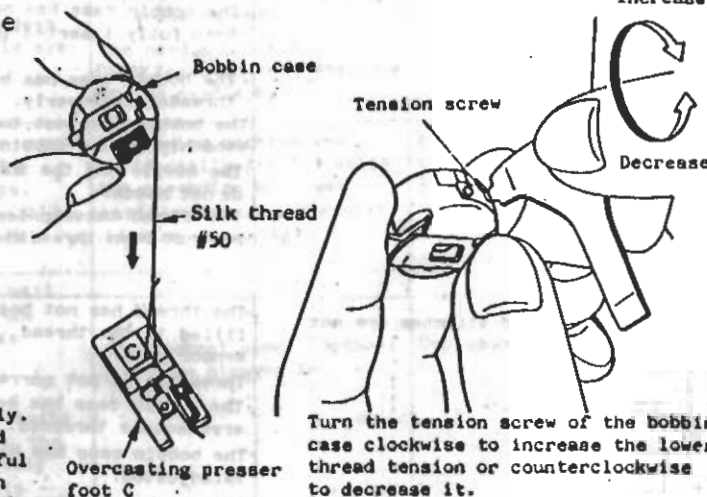



Set a bobbin with silk thread (count #50) wound on into the bobbin case. Attach the overcasting presser foot C to the open end of the thread, and lightly shake the bobbin case. At this time, the overcasting presser foot should go down slowly. This is the standard lower thread tension. (At this time, be careful not to allow your fingers to touch the bobbin or the tension spring.)

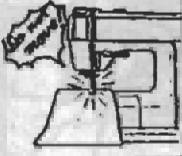
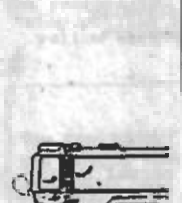

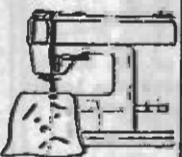
Turn the tension screw of the bobbin case clockwise to increase the lower thread tension or counterclockwise to decrease it.

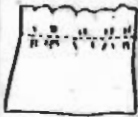
The following phenomena are not failures. Check again before you call for service.

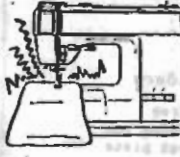
	Phenomenon	Cause (Reason)	Action to be taken	Page
	<p>The sewing machine suddenly stops during a sewing cycle.</p> <p>The light is on, and the handwheel can be turned by hand smoothly.</p>	<ul style="list-style-type: none"> The sewing machine has been run at low sewing speed for an extended period of time. The machine is designed to automatically turn the motor power OFF to prevent motor overheat. 	<ul style="list-style-type: none"> Turn the power switch OFF, and wait for about 20 minutes. The safety device will be reset, making the machine ready for restart. 	
	<p>The needle will not move even when you press the start/stop switch.</p>	<ul style="list-style-type: none"> The upper thread has run out. The presser foot lifting/thread trimming lever is up. The bobbin winder shaft is left in the right position. The buttonholing lever has not been lowered when the machine has been put in the buttonholing mode. 	<ul style="list-style-type: none"> Replace the empty spool, and press the start/stop switch. Lower the presser foot lifting/thread trimming lever to the horizontal position. Move the bobbin winder shaft back fully to the left. Lower the buttonholing lever. 	<p>12</p> <p>12</p> <p>12</p> <p>12</p>
	<p>The sewing machine will not run even when the start/stop switch is pressed. (The light lights.)</p>	<ul style="list-style-type: none"> The presser foot is not to the correct one, and the needle hits the presser foot. The sewing machine was started with the needle, which had come off the needle bar, left in the hook. The sewing machine was started without a bobbin case. (The thread is entangled onto the hook shaft.) The thread has been caught in the hook. 	<ul style="list-style-type: none"> Replace the presser foot with the correct one. Remove the needle. Cut the thread entangled on the shaft and remove it before inserting a bobbin case in the hook. Lubricate the hook, turn the handwheel back and forth several times, and remove the thread. 	<p>9</p>
	<p>The thread breaks.</p> <p>Stitches are skipped.</p>	<ul style="list-style-type: none"> Threading is not correct. The thread has a knot or joint. The thread tension is not correct. The needle is bent or the needle point is crushed. The needle has been attached improperly. The bobbin case has not been fully inserted in the hook. The bobbin case has been threaded improperly. The bobbin does not turn smoothly in the bobbin case. The needle and the threads do not match. The thread take-up lever has not been threaded. 	<ul style="list-style-type: none"> Correctly thread the machine head. Remove the knot or joint. Correct the thread tension. Replace the needle. Properly attach the needle. Securely set the bobbin case into the hook. Correctly thread the bobbin case. Check if the bobbin has been wound evenly. Use a proper thread or needle. Check the threading order. 	<p>7,8</p> <p>13</p> <p>13</p> <p>6</p> <p>6</p> <p>5,6</p> <p>14</p> <p>7</p>
	<p>Good stitches are not formed.</p>	<ul style="list-style-type: none"> The thread has not been filled in the thread sensor guide. Threading is not correct. The bobbin case has been erroneously threaded. The bobbin case has been misadjusted. The spool retaining cap is unsuited to the spool used. 	<ul style="list-style-type: none"> Fully push the thread into the thread sensor guide. Correct the threading. Correctly thread the bobbin case. Correctly adjust the bobbin case. Replace the cap with the one having the correct size. 	<p>7</p> <p>7,8</p> <p>6</p> <p>28</p> <p>6</p>

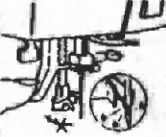
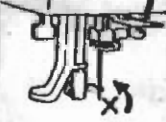
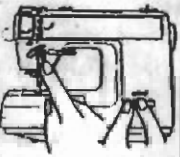
	<p>Puckering</p>	<ul style="list-style-type: none"> The stitch length is too large for the light-weight material. The needle point is crushed. 	<ul style="list-style-type: none"> Decrease the stitch length. Replace the needle. 	<p>10 13</p>
	<p>The needle breaks.</p>	<ul style="list-style-type: none"> A thin needle was used for sewing heavy-weight material. The needle has not been fully inserted into the hole in the needle bar. The needle clamp screw is loose. The presser foot is not the correct one. 	<ul style="list-style-type: none"> Use the correct needle. Properly attach the needle. Securely tighten the needle clamp screw. Use the correct presser foot. 	<p>13 13 13 9</p>
	<p>Loud noise is heard.</p>	<ul style="list-style-type: none"> Dust has accumulated on the feed dog. The machine is in need of lubrication after an extended operation. The machine has been lubricated with an oil other than the machine oil. Fibrous wastes are in the hook. 	<ul style="list-style-type: none"> Clean the machine. Lubricate the machine. Use the machine oil. Clean the machine. 	<p>28 28 28</p>
	<p>The handwheel cannot be turned.</p>	<p>The hook has been entangled with thread.</p>	<p>Lubricate the hook, then turn the handwheel back and forth several times to remove the thread.</p>	
	<p>The machine does not feed the material.</p>	<ul style="list-style-type: none"> The stitch length has been set to zero. The presser foot pressure is inadequate. 	<ul style="list-style-type: none"> Reselect the desired stitch pattern, and the proper stitch length will be set. Set the presser foot pressure adjustment dial to "STANDARD" 	<p>10</p>
	<p>Threading cannot be done. The threading hook does not turn.</p> <p>The threading hook does not enter the needle eye.</p>	<ul style="list-style-type: none"> The needle is not in the upper position. The threading hook is designed not to turn to protect itself if the needle is not up. The needle has not been fully inserted into the hole in the needle bar. 	<ul style="list-style-type: none"> Turn the handwheel until the needle reaches its highest position. Properly attach the needle. 	<p>8 13</p>
	<p>The threading lever cannot be returned, and the sewing machine stops. The threading hook is left in the needle eye.</p>	<p>The sewing machine was accidentally started while the threading hook was still in the needle eyelet (during threading).</p>	<p>Slightly turn the handwheel by hand away from you (in the reverse direction).</p>	
	<p>The sewing machine will not start even if the start/stop switch is pressed.</p> <p>The sewing speed remains unchanged even when the sewing speed adjusting lever is moved while sewing.</p>	<p>The control pedal (option) has been plugged in.</p>	<p>Unplug the control pedal.</p>	<p>27</p>

If any of the above phenomena should still remain even after you have taken the action given in the table, please contact a JUKI service center or the store at which you bought your sewing machine.

JUKI options add to the pleasure in your sewing.

These options are available from a JUKI service center or the store where you bought your sewing machine.

Transparent buttonholing
presser foot

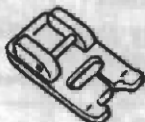

Suited for buttonholing
overlapping seam allowances

Concealed zipper
presser foot



Suited for sewing
concealed zippers

Rolled hemming presser foot



Suited for hemming the
bottoms of shirts and
blouses, and the edges of
scarves and frills.

Cording presser foot

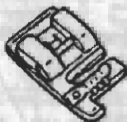

Suited for attaching
woolen yarn, embroidery
floss, silk buttonhole twist
and other cords to children's
wear, aprons, small goods, etc.

Unison walking foot



Suited for hard-to-feed
materials such as knit, jersey,
quilting, satin, vinyl-coated
cloth, man-made leather, and
leather.

Free embroidery

You can enjoy free
embroidery by using the
embroidery throat plate
and embroidery frame.

JUKI®

TOKYO JUKI INDUSTRIAL CO. LTD.

2-1, 8-CHOME CHOFU-SHI, TOKYO
TEL. TOKYO 03-480-5655